



IMPORTANT NOTICE

10 December 2015

1. Global joint venture starts operations as WeEn Semiconductors

Dear customer,

As from November 9th, 2015 NXP Semiconductors N.V. and Beijing JianGuang Asset Management Co. Ltd established Bipolar Power joint venture (JV), **WeEn Semiconductors**, which will be used in future Bipolar Power documents together with new contact details.

In this document where the previous NXP references remain, please use the new links as shown below.

WWW - For www.nxp.com use www.ween-semi.com

Email - For salesaddresses@nxp.com use salesaddresses@ween-semi.com

For the copyright notice at the bottom of each page (or elsewhere in the document, depending on the version) “© **NXP Semiconductors N.V. {year}. All rights reserved**” becomes “© **WeEn Semiconductors Co., Ltd. {year}. All rights reserved**”

If you have any questions related to this document, please contact our nearest sales office via e-mail or phone (details via salesaddresses@ween-semi.com).

Thank you for your cooperation and understanding,

WeEn Semiconductors



DATA SHEET

BYW29EX series
Rectifier diodes
ultrafast, rugged

Product specification

October 1998



**Rectifier diodes
ultrafast, rugged**

BYW29EX series

GENERAL DESCRIPTION

Glass passivated epitaxial rectifier diodes in a full pack plastic envelope, featuring low forward voltage drop, ultra-fast recovery times, soft recovery characteristic and guaranteed reverse surge and ESD capability. They are intended for use in switched mode power supplies and high frequency circuits in general where low conduction and switching losses are essential.

QUICK REFERENCE DATA

SYMBOL	PARAMETER	MAX.	MAX.	UNIT
V_{RRM}	Repetitive peak reverse voltage	150	200	V
V_F	Forward voltage	0.895	0.895	V
$I_{F(AV)}$	Forward current	8	8	A
t_{rr}	Reverse recovery time	25	25	ns
I_{RRM}	Repetitive peak reverse current	0.2	0.2	A

PINNING - SOD113

PIN	DESCRIPTION
1	cathode
2	anode
case	isolated

PIN CONFIGURATION

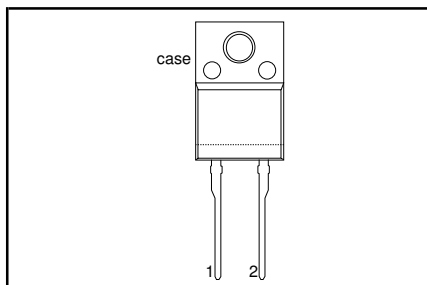

SYMBOL

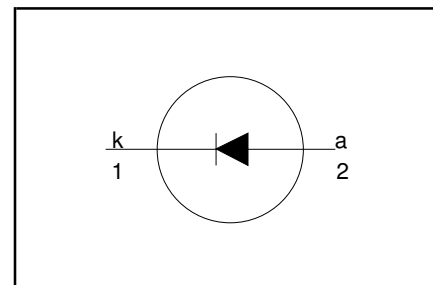

LIMITING VALUES

Limiting values in accordance with the Absolute Maximum System (IEC 134).

SYMBOL	PARAMETER	CONDITIONS	MIN.	MAX.		UNIT
V_{RRM}	Repetitive peak reverse voltage		-	-150	-200	V
V_{RWM}	Crest working reverse voltage		-	150	200	V
V_R	Continuous reverse voltage		-	150	200	V
$I_{F(AV)}$	Average forward current ¹	square wave; $\delta = 0.5$; $T_{hs} \leq 106^\circ\text{C}$ sinusoidal; $a = 1.57$; $T_{hs} \leq 109^\circ\text{C}$	-	8		A
$I_{F(RMS)}$	RMS forward current		-	7.3		A
I_{FRM}	Repetitive peak forward current	$t = 25 \mu\text{s}$; $\delta = 0.5$; $T_{hs} \leq 106^\circ\text{C}$	-	11.3		A
I_{FSM}	Non-repetitive peak forward current	$t = 10 \text{ ms}$ $t = 8.3 \text{ ms}$ sinusoidal; with reapplied	-	80		A
$I_{FSM}^2 t$	$I^2 t$ for fusing	$V_{RWM(max)}$ $t = 10 \text{ ms}$	-	32		A ² s
I_{RRM}	Repetitive peak reverse current	$t_p = 2 \mu\text{s}$; $\delta = 0.001$	-	0.2		A
I_{RSM}	Non-repetitive peak reverse current	$t_p = 100 \mu\text{s}$	-	0.2		A
T_{stg}	Storage temperature		-40	150		$^\circ\text{C}$
T_j	Operating junction temperature		-	150		$^\circ\text{C}$

¹ Neglecting switching and reverse current losses

Rectifier diodes ultrafast, rugged

BYW29EX series

ESD LIMITING VALUE

SYMBOL	PARAMETER	CONDITIONS	MIN.	MAX.	UNIT
V_C	Electrostatic discharge capacitor voltage	Human body model; $C = 250 \text{ pF}$; $R = 1.5 \text{ k}\Omega$	-	8	kV

ISOLATION LIMITING VALUE & CHARACTERISTIC

$T_{hs} = 25 \text{ }^\circ\text{C}$ unless otherwise specified

SYMBOL	PARAMETER	CONDITIONS	MIN.	TYP.	MAX.	UNIT
V_{isol}	R.M.S. isolation voltage from both terminals to external heatsink	$f = 50\text{-}60 \text{ Hz}$; sinusoidal waveform; R.H. $\leq 65\%$; clean and dustfree	-		2500	V
C_{isol}	Capacitance from both terminals to external heatsink	$f = 1 \text{ MHz}$	-	10	-	pF

THERMAL RESISTANCES

SYMBOL	PARAMETER	CONDITIONS	MIN.	TYP.	MAX.	UNIT
$R_{th\ j\text{-}hs}$	Thermal resistance junction to heatsink	with heatsink compound	-	-	5.5	K/W
$R_{th\ j\text{-}a}$	Thermal resistance junction to ambient	without heatsink compound in free air	-	55	7.2	K/W

STATIC CHARACTERISTICS

$T_j = 25 \text{ }^\circ\text{C}$ unless otherwise stated

SYMBOL	PARAMETER	CONDITIONS	MIN.	TYP.	MAX.	UNIT
V_F	Forward voltage	$I_F = 8 \text{ A}$; $T_j = 150 \text{ }^\circ\text{C}$	-	0.80	0.895	V
		$I_F = 8 \text{ A}$	-	0.92	1.05	V
		$I_F = 20 \text{ A}$	-	1.1	1.3	V
I_R	Reverse current	$V_R = V_{RWM}$; $T_j = 100 \text{ }^\circ\text{C}$	-	0.2	0.6	mA
		$V_R = V_{RWM}$	-	2	10	μA

DYNAMIC CHARACTERISTICS

$T_j = 25 \text{ }^\circ\text{C}$ unless otherwise stated

SYMBOL	PARAMETER	CONDITIONS	MIN.	TYP.	MAX.	UNIT
Q_s	Reverse recovery charge	$I_F = 2 \text{ A}$; $V_R \geq 30 \text{ V}$; $-di_F/dt = 20 \text{ A}/\mu\text{s}$	-	4	11	nC
t_{rr1}	Reverse recovery time	$I_F = 1 \text{ A}$; $V_R \geq 30 \text{ V}$; $-di_F/dt = 100 \text{ A}/\mu\text{s}$	-	20	25	ns
t_{rr2}	Reverse recovery time	$I_F = 0.5 \text{ A}$ to $I_R = 1 \text{ A}$; $I_{rec} = 0.25 \text{ A}$	-	15	20	ns
V_{fr}	Forward recovery voltage	$I_F = 1 \text{ A}$; $di_F/dt = 10 \text{ A}/\mu\text{s}$	-	1	-	V

Rectifier diodes
ultrafast, rugged

BYW29EX series

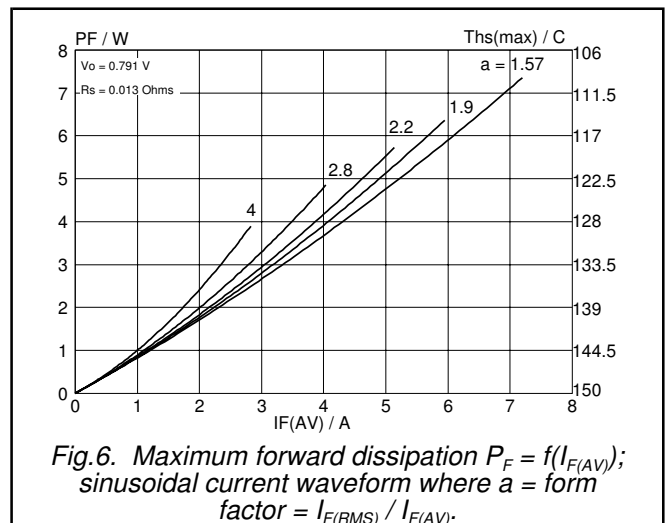
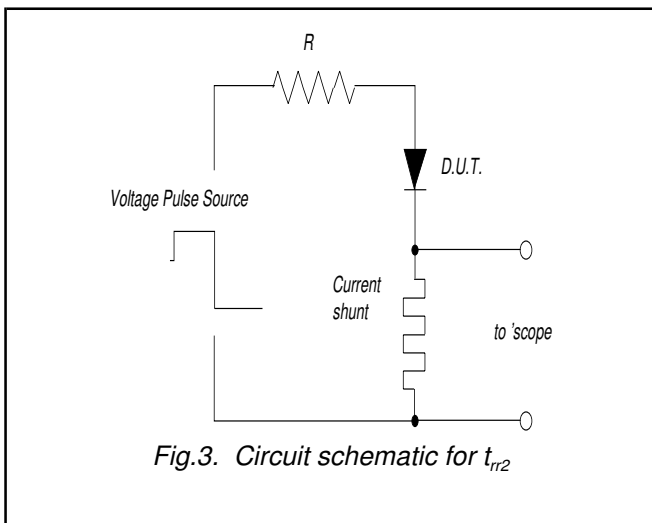
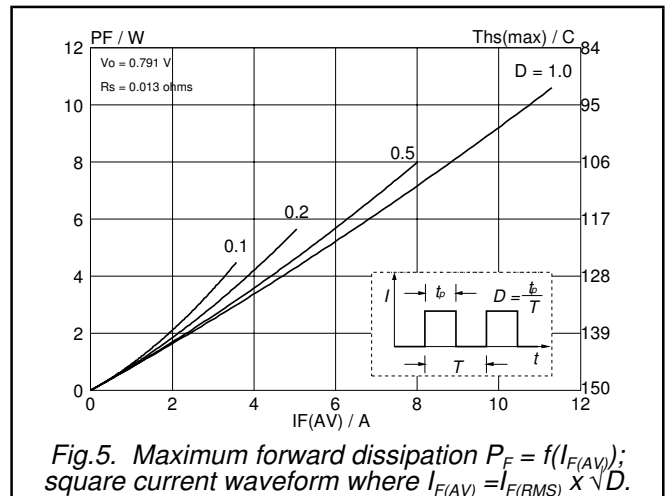
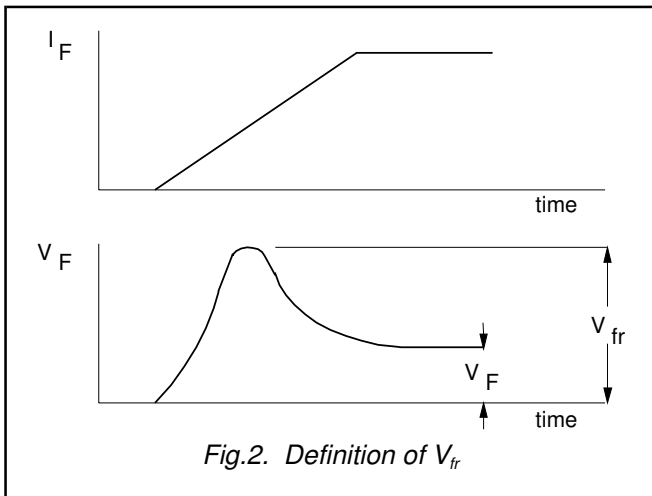
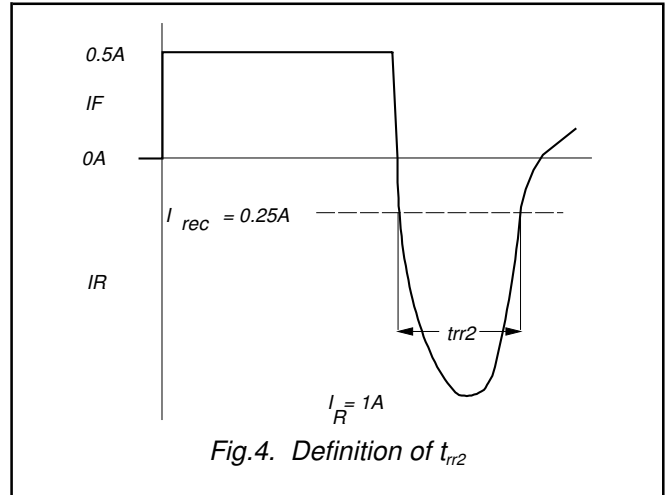
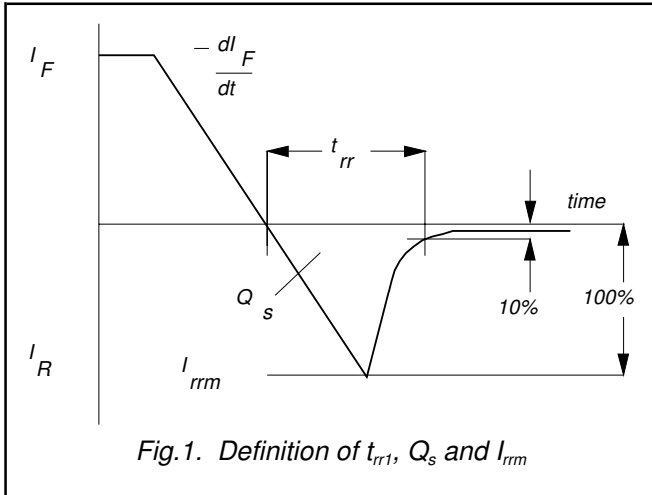

Rectifier diodes
ultrafast, rugged

BYW29EX series

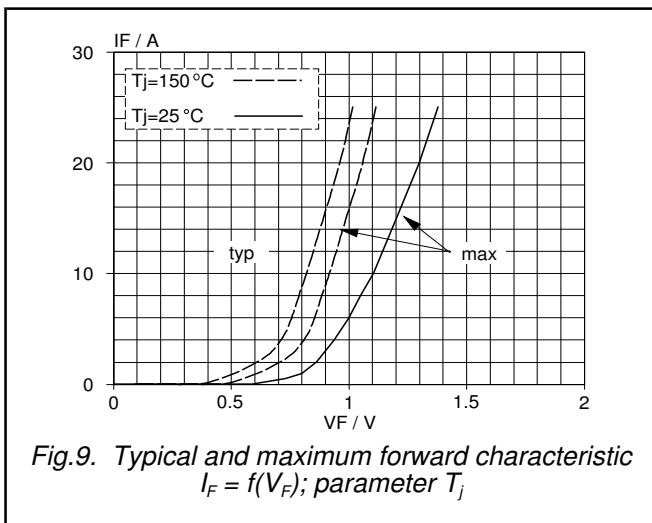
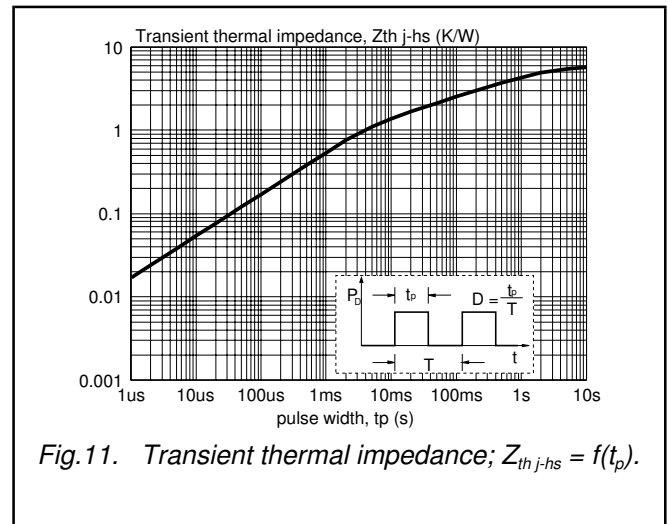
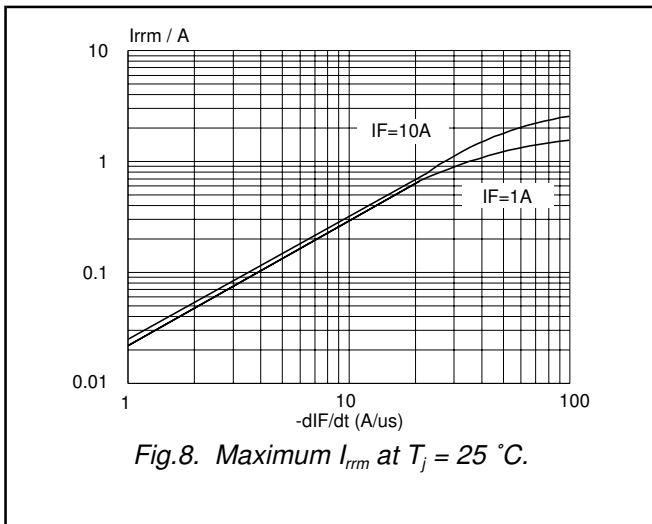
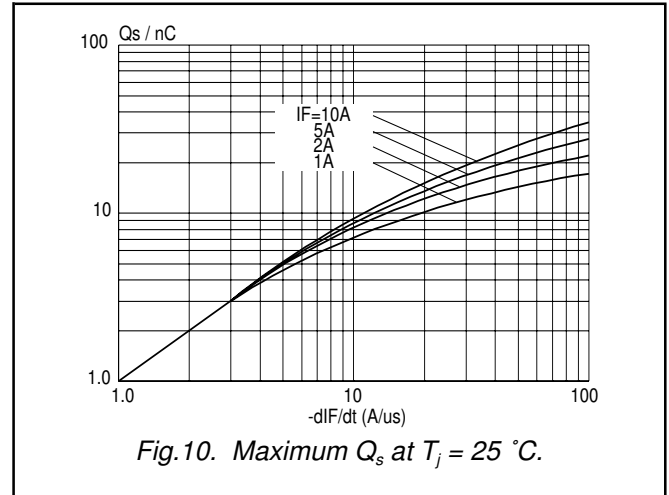
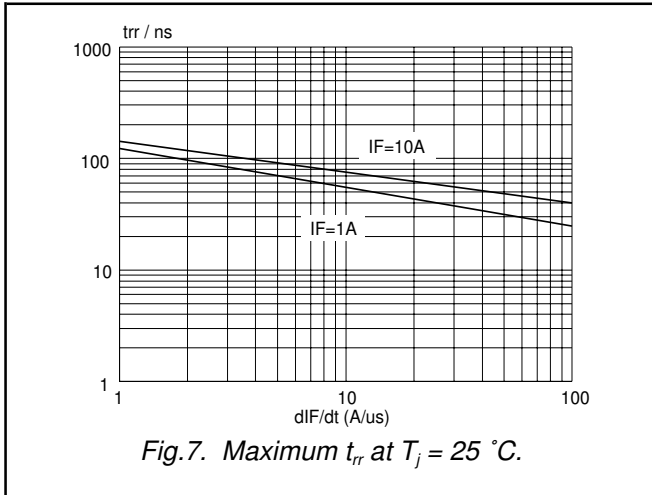

Rectifier diodes
ultrafast, rugged

BYW29EX series

MECHANICAL DATA

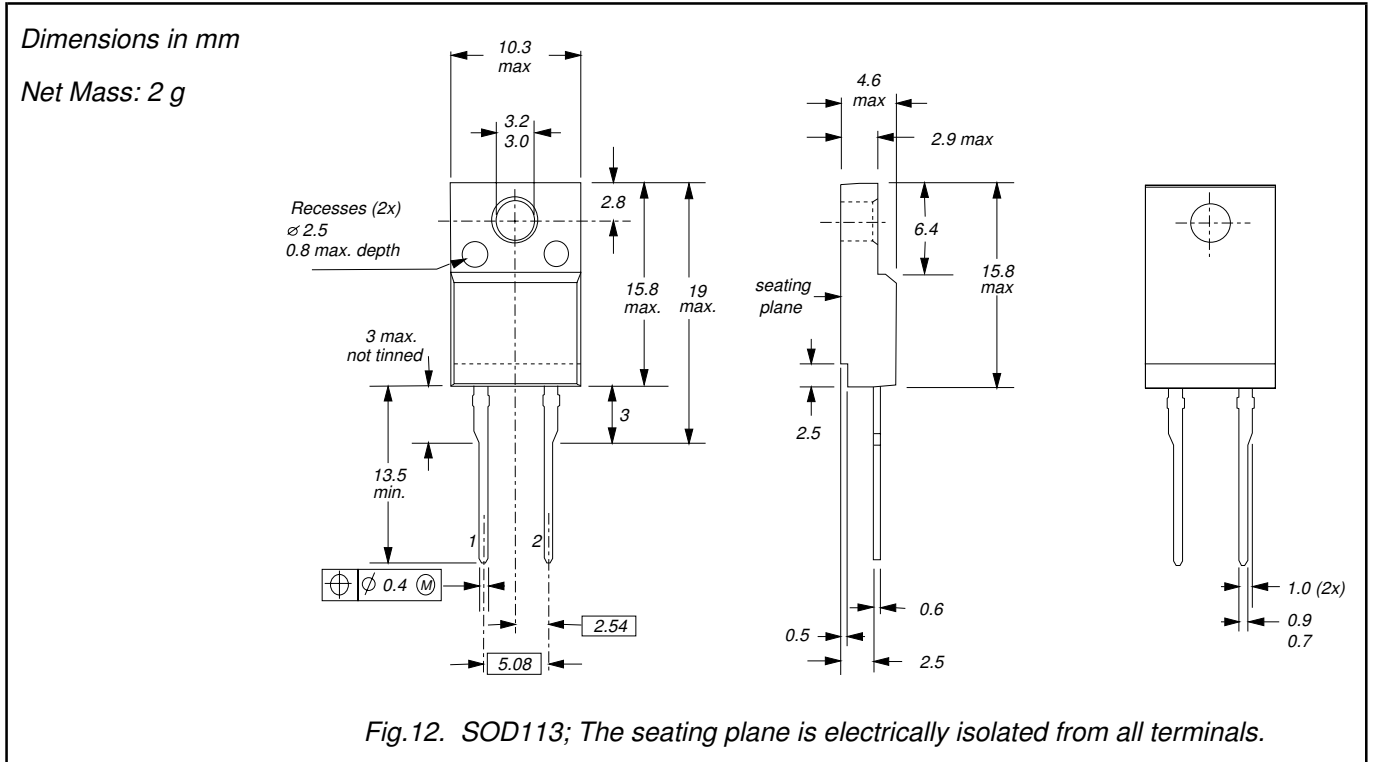

Notes

1. Refer to mounting instructions for F-pack envelopes.
2. Epoxy meets UL94 V0 at 1/8".

Legal information

DATA SHEET STATUS

DOCUMENT STATUS ⁽¹⁾	PRODUCT STATUS ⁽²⁾	DEFINITION
Objective data sheet	Development	This document contains data from the objective specification for product development.
Preliminary data sheet	Qualification	This document contains data from the preliminary specification.
Product data sheet	Production	This document contains the product specification.

Notes

1. Please consult the most recently issued document before initiating or completing a design.
2. The product status of device(s) described in this document may have changed since this document was published and may differ in case of multiple devices. The latest product status information is available on the Internet at URL <http://www.nxp.com>.

DEFINITIONS

Product specification — The information and data provided in a Product data sheet shall define the specification of the product as agreed between NXP Semiconductors and its customer, unless NXP Semiconductors and customer have explicitly agreed otherwise in writing. In no event however, shall an agreement be valid in which the NXP Semiconductors product is deemed to offer functions and qualities beyond those described in the Product data sheet.

DISCLAIMERS

Limited warranty and liability — Information in this document is believed to be accurate and reliable. However, NXP Semiconductors does not give any representations or warranties, expressed or implied, as to the accuracy or completeness of such information and shall have no liability for the consequences of use of such information.

In no event shall NXP Semiconductors be liable for any indirect, incidental, punitive, special or consequential damages (including - without limitation - lost profits, lost savings, business interruption, costs related to the removal or replacement of any products or rework charges) whether or not such damages are based on tort (including negligence), warranty, breach of contract or any other legal theory.

Notwithstanding any damages that customer might incur for any reason whatsoever, NXP Semiconductors' aggregate and cumulative liability towards customer for the products described herein shall be limited in accordance with the *Terms and conditions of commercial sale* of NXP Semiconductors.

Right to make changes — NXP Semiconductors reserves the right to make changes to information published in this document, including without limitation specifications and product descriptions, at any time and without notice. This document supersedes and replaces all information supplied prior to the publication hereof.

Suitability for use — NXP Semiconductors products are not designed, authorized or warranted to be suitable for use in life support, life-critical or safety-critical systems or equipment, nor in applications where failure or malfunction of an NXP Semiconductors product can reasonably be expected to result in personal injury, death or severe property or environmental damage. NXP Semiconductors accepts no liability for inclusion and/or use of NXP Semiconductors products in such equipment or applications and therefore such inclusion and/or use is at the customer's own risk.

Applications — Applications that are described herein for any of these products are for illustrative purposes only. NXP Semiconductors makes no representation or warranty that such applications will be suitable for the specified use without further testing or modification.

Customers are responsible for the design and operation of their applications and products using NXP Semiconductors products, and NXP Semiconductors accepts no liability for any assistance with applications or customer product design. It is customer's sole responsibility to determine whether the NXP Semiconductors product is suitable and fit for the customer's applications and products planned, as well as for the planned application and use of customer's third party customer(s). Customers should provide appropriate design and operating safeguards to minimize the risks associated with their applications and products.

Legal information

NXP Semiconductors does not accept any liability related to any default, damage, costs or problem which is based on any weakness or default in the customer's applications or products, or the application or use by customer's third party customer(s). Customer is responsible for doing all necessary testing for the customer's applications and products using NXP Semiconductors products in order to avoid a default of the applications and the products or of the application or use by customer's third party customer(s). NXP does not accept any liability in this respect.

Limiting values — Stress above one or more limiting values (as defined in the Absolute Maximum Ratings System of IEC 60134) will cause permanent damage to the device. Limiting values are stress ratings only and (proper) operation of the device at these or any other conditions above those given in the Recommended operating conditions section (if present) or the Characteristics sections of this document is not warranted. Constant or repeated exposure to limiting values will permanently and irreversibly affect the quality and reliability of the device.

Terms and conditions of commercial sale — NXP Semiconductors products are sold subject to the general terms and conditions of commercial sale, as published at <http://www.nxp.com/profile/terms>, unless otherwise agreed in a valid written individual agreement. In case an individual agreement is concluded only the terms and conditions of the respective agreement shall apply. NXP Semiconductors hereby expressly objects to applying the customer's general terms and conditions with regard to the purchase of NXP Semiconductors products by customer.

No offer to sell or license — Nothing in this document may be interpreted or construed as an offer to sell products

that is open for acceptance or the grant, conveyance or implication of any license under any copyrights, patents or other industrial or intellectual property rights.

Export control — This document as well as the item(s) described herein may be subject to export control regulations. Export might require a prior authorization from national authorities.

Quick reference data — The Quick reference data is an extract of the product data given in the Limiting values and Characteristics sections of this document, and as such is not complete, exhaustive or legally binding.

Non-automotive qualified products — Unless this data sheet expressly states that this specific NXP Semiconductors product is automotive qualified, the product is not suitable for automotive use. It is neither qualified nor tested in accordance with automotive testing or application requirements. NXP Semiconductors accepts no liability for inclusion and/or use of non-automotive qualified products in automotive equipment or applications.

In the event that customer uses the product for design-in and use in automotive applications to automotive specifications and standards, customer (a) shall use the product without NXP Semiconductors' warranty of the product for such automotive applications, use and specifications, and (b) whenever customer uses the product for automotive applications beyond NXP Semiconductors' specifications such use shall be solely at customer's own risk, and (c) customer fully indemnifies NXP Semiconductors for any liability, damages or failed product claims resulting from customer design and use of the product for automotive applications beyond NXP Semiconductors' standard warranty and NXP Semiconductors' product specifications.

Customer notification

This data sheet was changed to reflect the new company name NXP Semiconductors, including new legal definitions and disclaimers. No changes were made to the content, except for the legal definitions and disclaimers.

Contact information

For additional information please visit: <http://www.nxp.com>

For sales offices addresses send e-mail to: salesaddresses@nxp.com

© NXP B.V. 2011

All rights are reserved. Reproduction in whole or in part is prohibited without the prior written consent of the copyright owner.

The information presented in this document does not form part of any quotation or contract, is believed to be accurate and reliable and may be changed without notice. No liability will be accepted by the publisher for any consequence of its use. Publication thereof does not convey nor imply any license under patent- or other industrial or intellectual property rights.

Printed in The Netherlands