

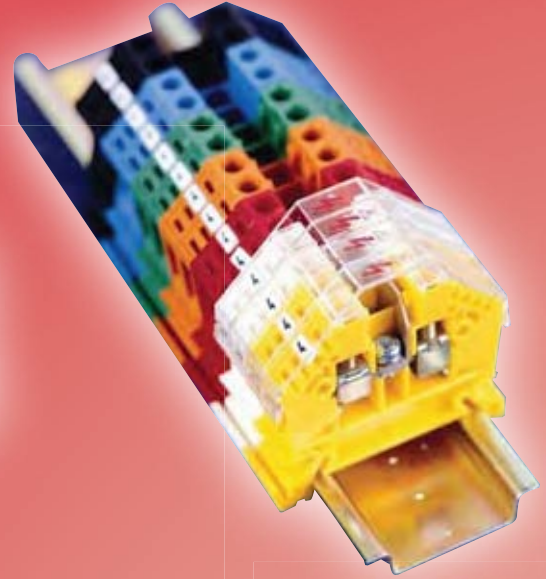

**Curtis**

We Build Confidence!



# Terminal Blocks



**Curtis Industries**

A Div. of Powers Holdings, Inc.



# ***Curtis Industries***

**A Division of Powers Holdings, Inc.**

Curtis Industries is recognized as a leader in North American Style Terminal Blocks. We focus on five key areas to insure high quality and total customer satisfaction using the latest technology. These key areas include Customer Satisfaction, Design Engineering, Manufacturing, Quality, and On-Time Delivery.



**Customer Satisfaction** is carried out throughout Curtis. Customer interface with our friendly and knowledgeable Customer Service Representative where all the information needed for order entry, processing, shipping, pricing, and order expediting are immediately available electronically.



**Design Engineering** is able to create new designs to solve our OEM customer's requirements. Using the Solid Works modeling technology enables our engineers to design the optimum terminal blocks or custom control package.



**Manufacturing** uses proprietary techniques with semi and full automation to build in quality and reduce thru-put. We deliver 99.9% reliable product to meet our customer's quality objectives.



**Manufacturing** uses Cellular and Lean manufacturing technologies to maintain high quality, short lead time and lower costs. We deliver 99.9% reliable product to meet our customer's quality objectives.



**On-Time Delivery** is a focus for everyone at Curtis which has resulted in an on-time delivery greater than 98% on time.

# Contents

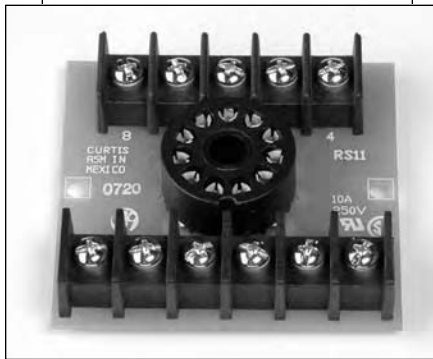
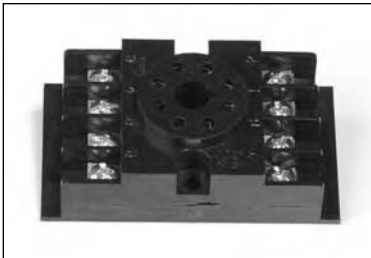
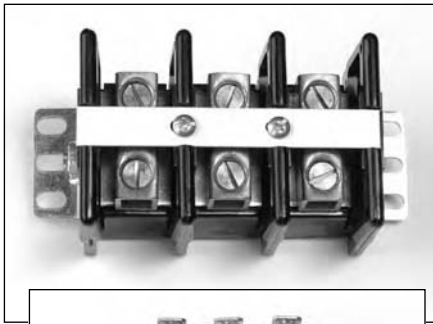

Selection Guide ..... 2

## **BARRIER STYLE TERMINAL BLOCKS ]**

### *Single Row*

SE/SEI ..... 6  
 32500 ..... 8  
 37000/38000 ..... 10  
 CB/CFT ..... 16  
 43000 ..... 20  
 GFT/GB ..... 24

### *Dual Row*

1500 ..... 28  
 2000 ..... 30  
 M ..... 34  
 56000 ..... 36

### *High Voltage/Current*

Series SW & DSW ..... 38  
 Series W ..... 40  
 Types CDM ..... 42  
 Series 71000 ..... 44  
 Types H & BT ..... 46  
 Types T & U ..... 48  
 Types L, O & S ..... 50

## **RELAY SOCKETS ]**

Snap-In Socket Assemblies ..... 54

### *CUS Series*

CUS8 and CUS11 ..... 55  
 CUS5, CUS12 and CUS16 ..... 55

### *RS Series*

RS8, RS11 ..... 56  
 RS2, RS4 and RS6 ..... 57  
 RS12 and RS16 ..... 58  
 RS14, RS15 ..... 58

### *Accessories* ..... 60

## **DIN RAIL TERMINAL BLOCKS ]**

Din Rail Terminal Block Features ..... 62  
 Multiple Wire Connections ..... 63

### *Screw Connections*

Single Level ..... 64  
 Dual Level Block ..... 68

### *Screwless Connections*

Single Level ..... 70  
 Single Level, Multi ..... 71  
 Ground Blocks ..... 72

### *Fuse Blocks* ..... 73

### *Ground Blocks* ..... 75

### *Mounting Rails* ..... 77

### *Accessories* ..... 78



# Curtis Industries Terminal Block Selection Guide

## Barrier Style

Series/ Type	TERMINAL SPACINGS			TERMINAL TYPES				RATING		HOUSING			AGENCY Approvals		Catalog Page Number
	Center-to-Center Spacing	Wire Range (AWG)	Number of Terminals	Feed-Thru (Fully Insulated)	Feed Thru	Printed Circuit Surface (Fully Insulated)	Voltage (Varies with Application) see specifications	Current (Amps)	(Black) Phenolic *150°C (302°F)	Polyphenylene *110°C (230°F)	Thermoplastic-Poly *140°C (284°F)	Flammability	UL Recognition	CSA Certified	
<b>SE/SEI</b>	.250" (1/4") (6.35mm)	22 to 16	1 thru 26	•	•	•	•	250V	5			94V-0	•	•	6
<b>32500</b>	.325" (8.25mm)	22 to 14	1 thru 26		•	•	•	300V	15			94V-0	•	•	8
<b>37000/ 38000</b>	.375" (3/8") (9.52mm)	22 to 12	1 thru 26	•	•	•	•	300V	20			94V-0	•	•	10
<b>CB/CFT</b>	.375" (3/8") (9.52mm)	22 to 12	1 thru 26	•	•	•	•	600V	20			94V-0	•	•	16
<b>43000</b>	.4375" (7/16") (11.11mm)	22 to 12	1 thru 26	•	•	•	•	600V	30			94V-0	•	•	20
<b>GFT/GB</b>	.4375" (7/16") (11.11mm)	22 to 12	1 thru 26	•	•	•	•	600V	20	•	•	94V-0	•	•	24
<b>1500</b>	.375" (3/8") (9.52mm)	22 to 10	1 thru 22		•	•	•	300V	30			94V-0	•	•	28
<b>2000</b>	.4375" (7/16") (11.11mm)	22 to 10	1 thru 26		•	•	•	300V	20			94V-0	•	•	30
<b>M</b>	.50" (1/2") (12.7mm)	22 to 12	1 thru 24				•	300V	15	•		94V-1	•	•	34
<b>5600</b>	.563" (9/16") (14.29mm)	22 to 8	1 thru 22		•		•	600V	15-50	•		94V-0	•	•	36

## Barrier Style High Voltage

Series/ Type	TERMINAL SPACINGS			MOUNTING METHOD		RATING		HOUSING			AGENCY Approvals		Catalog Page Number	
	Center-to-Center Spacing	Wire Range (AWG)	Number of Terminals	Surface	Snap-in Track Modular Assembly	Voltage	Current (Amps)	(Black) Phenolic *150°C (302°F)	Thermoplastic-Poly *130°C (266°F)	Polyamide (Nylon) *125°C (257°F)	Flammability	UL Recognition		CSA Certified
<b>SW/ DSW</b>	.375" (3/8") (9.52mm)	22 to 8	2 thru 192		•	600V	25-50			•	94V-2	•	•	38
<b>W</b>	.4375" (7/16") (11.11mm)	22 to 4	2 thru 164		•	600V	75	•			94V-1	•	•	40
<b>CDM</b>	.547" (35/64") (13.86mm)	22 to 10	1 thru 50	•		600V	30		•		94V-0	•	•	42
<b>71000</b>	.629" (15.97mm)	22 to 1	2 thru 6		•	600V	86		•		94V-0	•	•	44
<b>H/BT</b>	.652" (16.56mm)	H - 16 to 4 BT - 22 to 10	1 thru 30	•		600V	75-30		•		94V-0	•	•	46
<b>T/U</b>	1.16" (29.46mm)	T - 6 to 1/0 U - 6 to 250 MCM	1 thru 6	•		600V	125-250	•			94V-1	•	•	48
<b>L</b>	1.16" (29.46mm)	Up to 1	1 thru 12	•		600V	100	•			94V-1	•	•	50
<b>O</b>	1.86" (47.24mm)	Up to 1/0	1 thru 4	•		600V	125	•			94V-1	•	•	50
<b>S</b>	2.42" (61.47mm)	Up to 4/0	1 thru 4	•		600V	225	•			94V-1	•	•	50





## Relay Sockets

Series/ Type	TERMINAL SPACINGS			STYLE		RELAYS					RATING		HOUSING		Catalog Page Number
				Octal	Square	SPDT	2PDT	3PDT	4PDT	6PDT	Voltage (Varies with Application) see specifications	Current (Amps)	Thermoplastic •110°C (230°F)		
	Center-to- Center Spacing	Wire Range (AWG)	Sockets	•	•	•	•	•	•						
<b>CUS 8</b>		22 to 12	8-pin	•		•					300V	10	•	55	
<b>CUS 11</b>			11-pin			•									
<b>CUS 5</b>		22 to 14	5-pin		•					250V	15	•	55		
<b>CUS 12</b>			8-pin	•	•										
<b>CUS 16</b>			11-pin		•										
<b>RS8</b>	.4375" (7/16") (11.11mm)	22 to 12	8-pin	•		•				250V	10	•	56		
<b>RS11</b>			11-pin			•									
<b>RS2</b>	.25" (1/4") (6.35mm)	22 to 16	10-pin			•				125V	5	•	57		
<b>RS4</b>			16-pin	•			•								
<b>RS6</b>			22-pin					•							
<b>RS12</b>	.4375" (7/16") (11.11mm)	22 to 12	8-pin	•			•			260V	10	•	58		
<b>RS16</b>			11-pin			•									
<b>RS14</b>	.25" (1/4") (6.35mm)	22 to 16	14-pin	•				•		125V	5	•	59		
<b>RS15</b>			15-pin					•							

## Din Rail

Series/Type	TERMINAL SPACINGS			STYLE		RATING		HOUSING		Catalog Page Number
				Screw	Screwless	Voltage (Varies with Application) see specifications	Current (Amps)	Thermoplastic Polyamide •125°C (230°F)	V-0 Self-Extinguishing	
	Spacing	Wire Range (AWG)	Wire Cross Section							
<b>Single Level</b>	5-26mm	24 to 10	2.5-70mm	•		800V	24-80	•		64
<b>Dual Level</b>	6 mm	24 to 10	4.0-6.0mm	•		600V	30	•		66
<b>Triple Level</b>	5.3 & 6mm	26 to 14	2.5mm	•		250V	24	•		69
<b>Single Level</b>	5mm	24 to 8	2.5-8.0mm		•	600V	20	•		70
<b>Single-Multi Level</b>	5mm	24 to 8	2.5-8.0mm		•	600V	20	•		70
<b>Ground</b>		24 to 10			•			•		72
<b>Fuse Block</b>	10mm		11/4-5.0mm	•		600V	15-30	•		73
<b>Din Ground</b>	2 - 25mm	30 to 12	2-25mm	•		300-750V	13.5-15		•	75



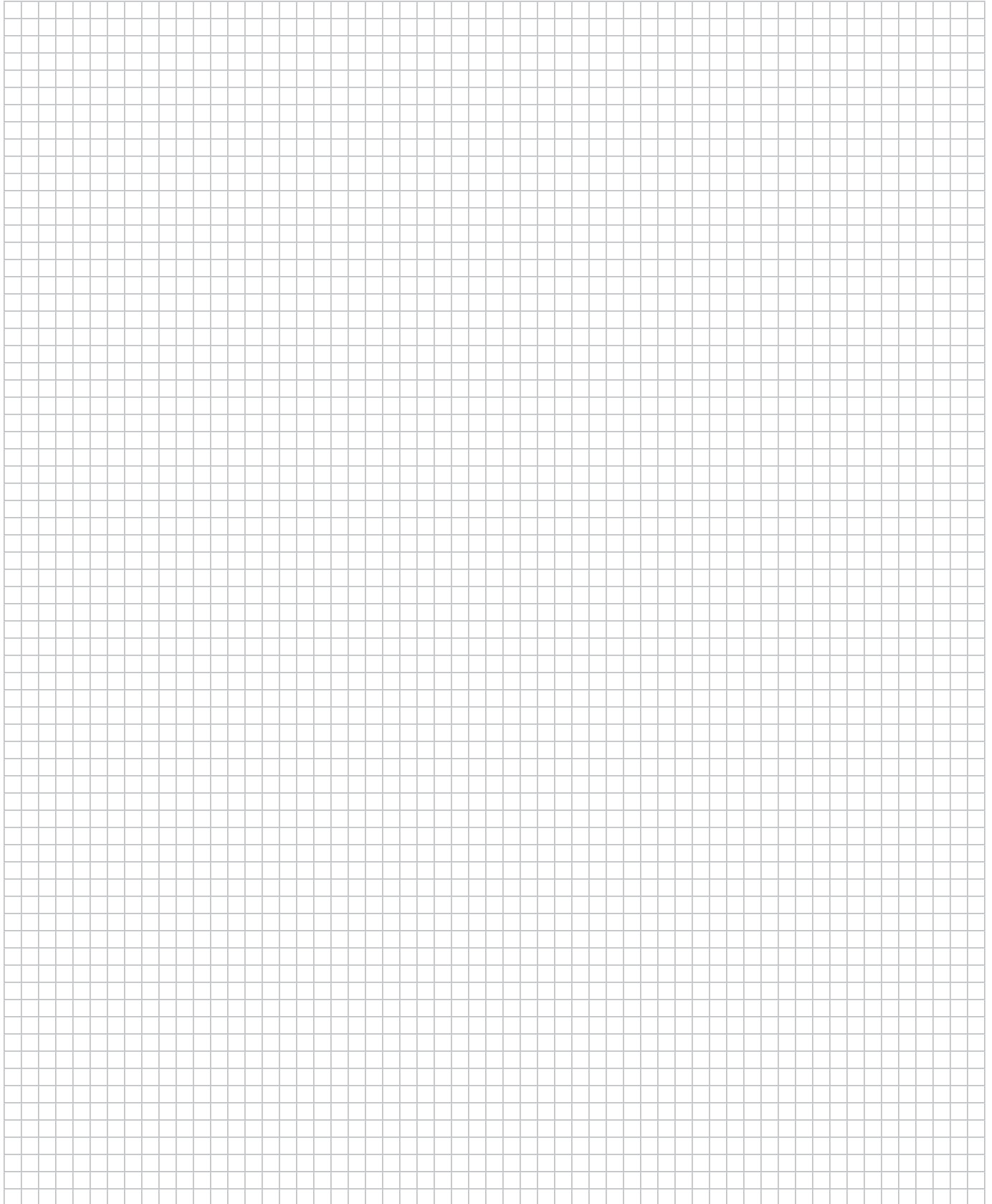

# BARRIER STYLE TERMINAL BLOCKS ]

*Single Row*

*Dual Row*

*High-Voltage/Current*

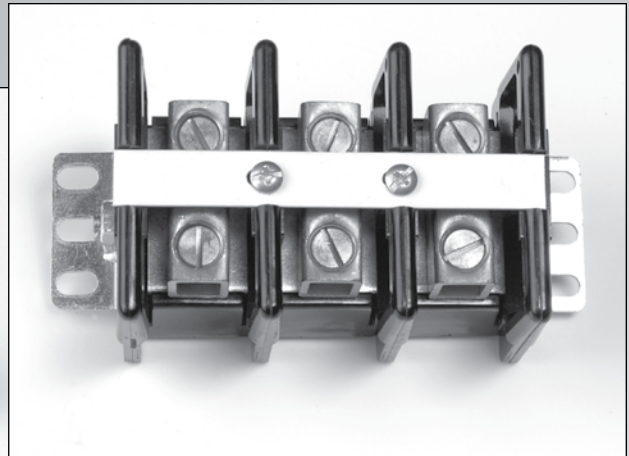
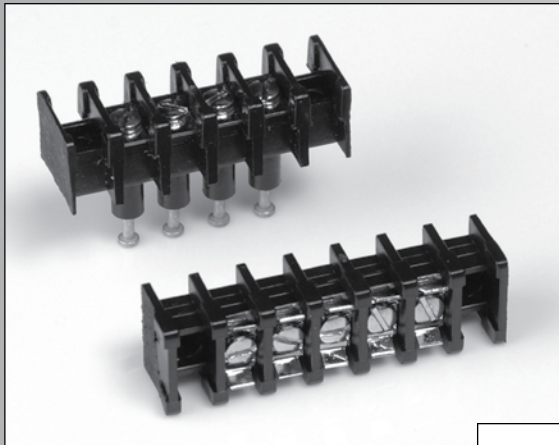

*Curtis Industries*  
A Division of Powers Holdings, Inc.



# Series SE/SEI .250" (1/4") 6.35mm Center-to-Center Spacing

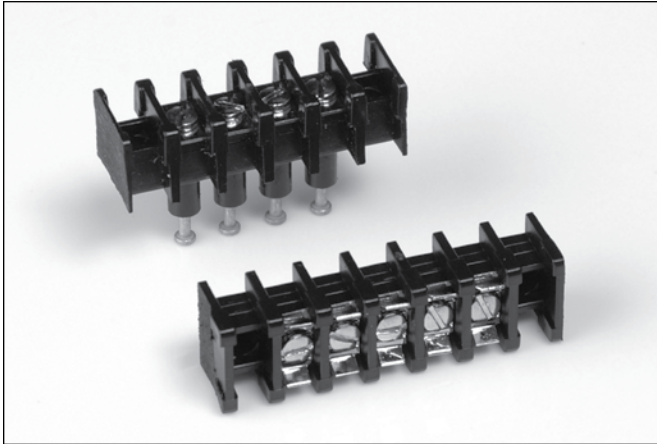

## Features:

- **Miniature Feed-Thru, Printed Circuit and Surface Connection** – SE Series miniature terminal blocks are designed for applications requiring the compactness and versatility of the SEI Series without full feed-thru insulation.
- **Barrier-Type Construction** – Blocks are made of high-impact, break-resistant thermoplastic molding with integrally mounted .116" diameter mounting holes. One thru 26 terminals on 1/4" center-to-center spacing.
- **Terminal Flexibility** – External terminals available in two No. 2-56 screw designs. Internal terminals include an .047" diameter printed circuit pin, and turret-type solder pins.
- **Wire Sizes** – No. 2-56 screws. UL recognized for No. 22AWG to No. 16AWG.
- **Recognition and Listing** – UL recognized
- **Standoffs** – SEPX and SEFX are now supplied with .020" standoffs for ease in cleaning after soldering.

Single Row

BARRIER STYLE

## VARIATIONS

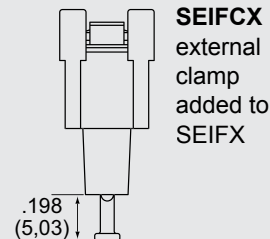
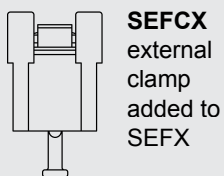
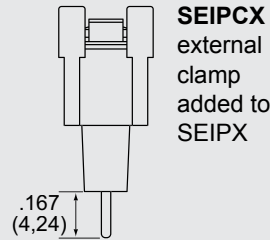
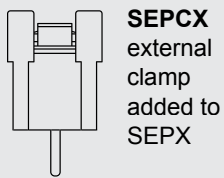
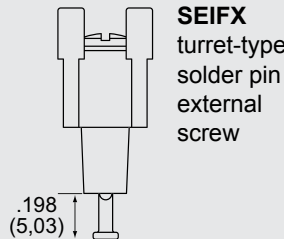
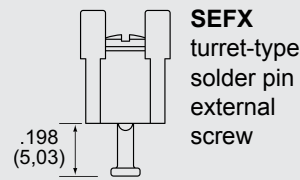
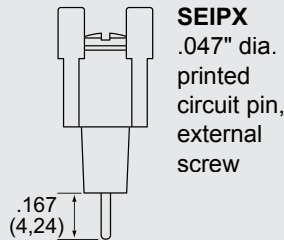
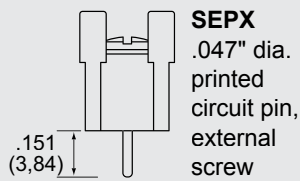

 Recognized under the Components Program of Underwriters Laboratories, Inc. Standard 1059, Guide No. XCFR2, File No. E62557.

 Guide No. 22.2 No. 158, Report No. LR39186-1.

## Internal Terminal Designations

- SEPX, SEIPX** printed circuit board design with .047" tin-plated brass pin
- SEFX, SEIFX** tin-plated brass turret-type solder pin

## External Terminal Designations

- SEPX, SEFX, SEIPX, SEIFX** No. 2-56 plated steel\* terminal screw accepting up to No. 16 AWG wire
- SEPCX, SEFCX, SEIPCX, SEIFCX** Nickel-plated brass surface clamp with No. 2-56 plated steel screw to eliminate lugging. Accepts wire up to No. 16AWG

## PC BOARD DRILLING DIMENSIONS

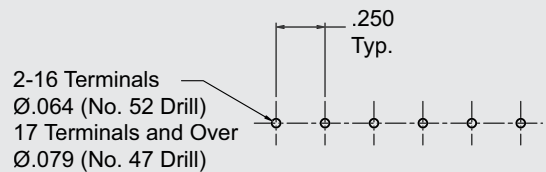

## Specifications:

**Center-to-Center Spacing:** .250" (6.35mm)

**Wire Range:** UL recognized for No. 22AWG to No. 16AWG. Models SEIPX, SEIFX, SEPX and SEFX with standard No. 2-56 plated steel screws are UL recognized "for factory wiring only." Models SEPCX, SEFCX, SEIPCX and SEIFCX are UL recognized "for field wiring" when ordered with special No. 2-56 stainless steel screw.

**No. of Terminals:** 1 thru 26

**Voltage Rating:** UL & CSA – 150 volts – General Industrial  
250 volts – Commercial  
Appliance

**Tightening Torque:** Wire Clamp with stainless steel screw 3 in.-lbs.

**Current Rating:** 5 amps UL

### Housing:

Material	Polyphenylene Oxide
Continuous Use Temp. (UL Index)	110° C (230° F)
Flammability Rating	94V-0
Water Absorption (24 hrs. % wt. gain)	.06%
Chemical Resistance	Resistant to inorganic bases and acids – for organic substances contact factory for specific resistances.

### Breakdown Voltage:

Terminal - Terminal	3,600 Typ.
Terminal - Ground	4,700 Typ.

## How to Order

SEI and SE Series terminal blocks are ordered by listing a composite number made up of the model designation followed by the number of poles required for the application.

Suffixes are used as follows:

R denotes model less mounting positions

\* The SEPX and SEFX are made with .020" standoffs for ease in cleaning after the soldering operation

## Series SE/SEI Dimensions

NOTE: mm dim. are shown in parentheses

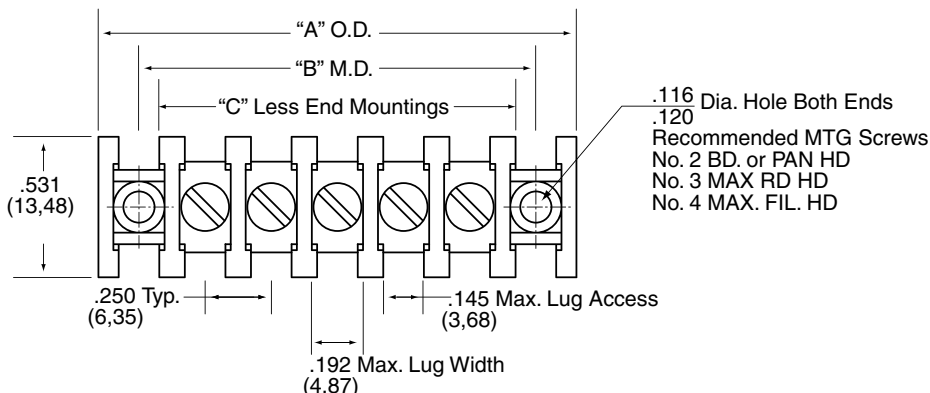

Number of Terminals	Series SE/SEI With Mounting Ends				Without Mounting Ends	
	Dimensions					
	A $\pm .031$ Overall Dimensions (O.D.)		B $\pm .031$ Mounting Dimensions (M.D.)		C $\pm .031$ Less Mounting Positions	
	Inches	Metric (mm)	Inches	Metric (mm)	Inches	Metric (mm)
1	.781	19.84	.500	12.70	.375	9.52
2	1.031	26.19	.750	19.05	.625	15.87
3	1.281	32.54	1.000	25.40	.875	22.22
4	1.531	38.89	1.250	31.75	1.125	28.57
5	1.187	45.24	1.500	38.10	1.375	34.92
6	2.031	51.59	1.750	44.45	1.625	41.27
7	2.281	57.94	2.000	50.80	1.875	47.62
8	2.531	64.29	2.250	57.15	2.125	53.97
9	2.781	70.64	2.500	63.50	2.375	60.32
10	3.031	76.99	2.750	69.85	2.625	66.67
11	3.281	83.34	3.000	96.20	2.875	73.02
12	3.531	89.69	3.250	82.55	3.125	79.37
13	3.781	96.04	3.500	88.90	3.375	85.72
14	4.031	102.39	3.750	95.25	3.625	92.07
15	4.281	108.74	4.000	101.60	3.875	98.42
16	4.531	115.09	4.250	107.95	4.125	104.77
17	4.781	121.44	4.500	114.30	4.375	111.12
18	5.031	127.79	4.750	120.65	4.625	117.47
19	5.281	134.14	5.000	127.00	4.875	123.82
20	5.531	140.49	5.250	133.35	5.125	130.17
21	5.781	146.84	5.500	139.70	5.375	136.52
22	6.031	153.19	5.750	146.05	5.625	142.87
23	6.281	159.54	6.000	152.40	5.875	149.22
24	6.531	165.89	6.250	158.75	6.125	155.57
25	6.781	172.24	6.500	165.10	6.375	161.92
26	7.031	178.59	6.750	171.45	6.625	168.27



# Series 32500 .325" Center-to-Center Spacing

Single Row

BARRIER STYLE

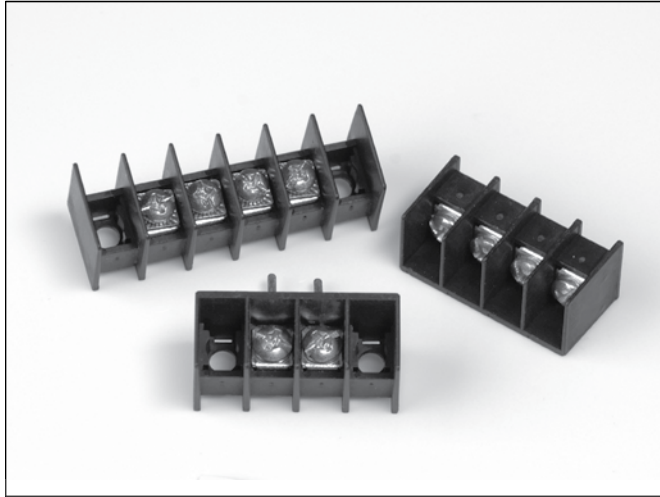

## 32500 Surface Mount With or Without Mounting Ends

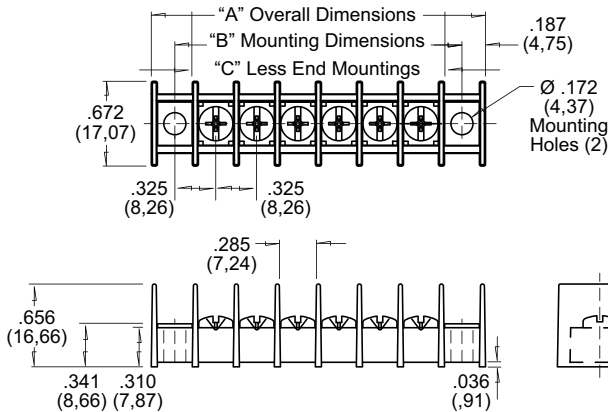

## Features:

- **Complete Line of .325" Offset Blocks** – Including base mount, P.C. Pin, wire wrap, turret, and right angle terminals
- **Open or Tri Barrier Designs** – To meet your wiring requirements
- **UL & CSA Recognized** – With a 94 V-O flammability rating
- **Molded in Standoffs** – To aid in the board cleaning process
- **A Multitude of Screw and Wire Terminals Available** – Including wire clamps, wire ready screws, and combo head screws

**UL** Recognized under the Components Program of Underwriters Laboratories, Inc. Standard 1059, Guide No. XCFR2, File No. E62557.

**CSA** Guide No. 22.2 No. 158, Report No. LR39186-1.

## 32500 Tri-Barrier Surface Mount With or Without Mounting Ends

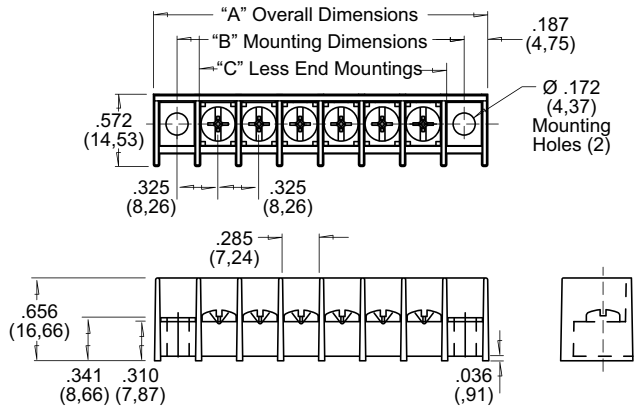

How to Order      325    X    X    X    XX    X

### MOLDING DESIGN

- 0 = Open Back w/ Mounting Ends
- 1 = Open Back w/o Mounting Ends
- 2 = Tri Barrier w/ Mounting Ends
- 3 = Tri Barrier w/o Mounting Ends

### INSERT OR BOTTOM TERMINATION DESIGN

- 0 = Base Mount Insert
- 1 = Printed Circuit Pin
- 2 = Wire Wrap Pin
- 3 = Turret Type Pin
- 4 = Right Angle Printed Circuit Pin

### SPECIALS OR OPTIONAL DESIGNS

- 0 = None
- A-Z = Custom Configuration

### NUMBER OF POSITIONS

1 thru 26, Available in One to Twenty-Six Positions

### HARDWARE OR TOP TERMINATION DESIGN

- 0 = Steel Combo Head Screw
- 1 = Wire Clamp Head Screw
- 2 = Brass Combo
- 3 = Stainless Steel Screw
- 5 = Supplied w/o Screws
- 6 = Quick Connects
- 8 = Captivated Steel Combo Head
- 9 = Captivated Wire Clamp





**Specifications:**

**Center-to-Center Spacing:** .325" (.825mm)  
**Wire Range:** No. 22AWG to 14AWG  
**No. of Terminals:** 1 thru 26 (28 without mounting holes)  
**Voltage Rating:** 300V  
**Tightening Torque:** 9 in. lb.  
**Current Rating:** 15 amps UL  
 (20 Amps with 12AWG & Lugs)

**Housing:**

Material Polypropylene  
 Continuous Use  
 Temp. (UL Index) 105°C (221°F)  
 Flammability Rating 94V-0  
 Water Absorption  
 (24 hrs. % wt. gain) .03%

**PC BOARD DRILLING DIMENSIONS**

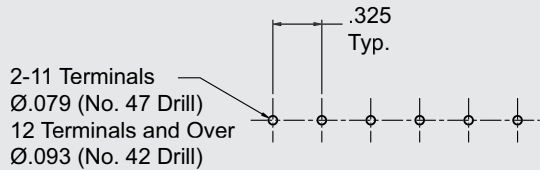

Number of Terminals	Series 32500 With Mounting Ends				Without Mounting Ends	
	Dimensions					
	A ± .031 Overall Dimensions (O.D.)		B ± .031 Mounting Dimensions (M.D.)		C ± .031 Less Mounting Ends	
	Inches	Metric (mm)	Inches	Metric (mm)	Inches	Metric (mm)
1	1.023	25.98	.650	16.51	.373	9.47
2	1.348	34.24	.975	24.77	.698	17.73
3	1.673	42.49	1.300	33.02	1.023	25.98
4	1.998	50.75	1.625	41.30	1.348	34.24
5	2.323	59.00	1.950	49.53	1.673	42.49
6	2.648	67.26	2.275	57.79	1.998	50.75
7	2.973	75.51	2.600	66.04	2.323	59.00
8	3.298	83.77	2.925	74.30	2.648	67.25
9	3.623	92.02	3.250	82.55	2.973	75.51
10	3.948	100.28	3.575	90.81	3.298	83.77
11	4.273	108.53	3.900	99.06	3.623	92.02
12	4.598	116.79	4.225	107.32	3.948	100.28
13	4.923	125.04	4.550	115.57	4.273	108.53
14	5.248	133.30	4.875	123.83	4.598	116.79
15	5.573	141.55	5.200	132.08	4.923	125.04
16	5.898	149.81	5.525	140.34	5.248	133.30
17	6.223	158.06	5.850	148.59	5.573	141.55
18	6.548	166.32	6.175	156.85	5.898	149.81
19	6.873	174.57	6.500	165.1	6.223	158.06
20	7.198	182.83	6.825	173.36	6.548	166.32
21	7.523	191.08	7.150	181.61	6.873	174.57
22	7.848	199.34	7.475	189.87	7.198	182.83
23	8.173	207.59	7.800	198.12	7.523	191.08
24	8.498	215.85	8.125	206.38	7.848	199.34
25	8.823	224.10	8.450	214.63	8.173	207.60
26	9.148	232.36	8.775	222.89	8.498	215.85
27					8.823	224.10
28					9.148	232.36

Dimensions shown are ± 0.030"

**Series 32500 Open Back**

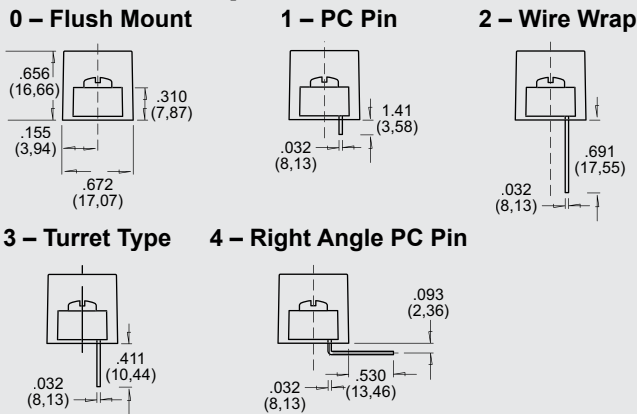

**Series 32500 Tri-Barrier**

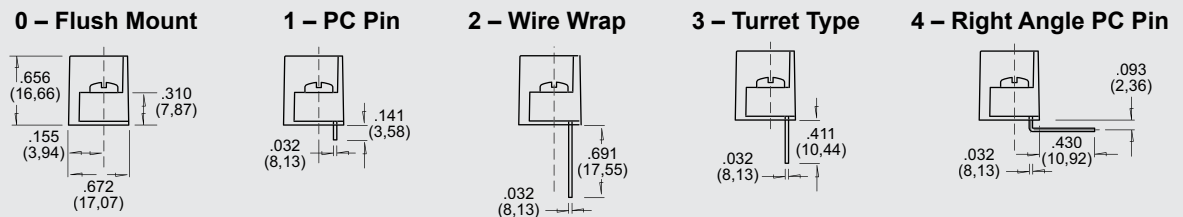

# Series 37000/38000 .375" (3/8") 9.52mm Center-to-Center Spacing

Single Row

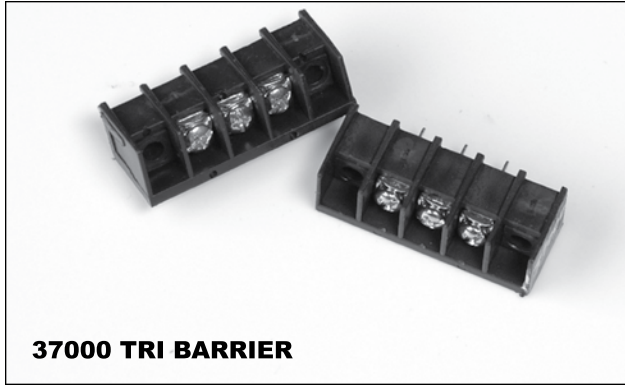

**37000 TRI BARRIER**

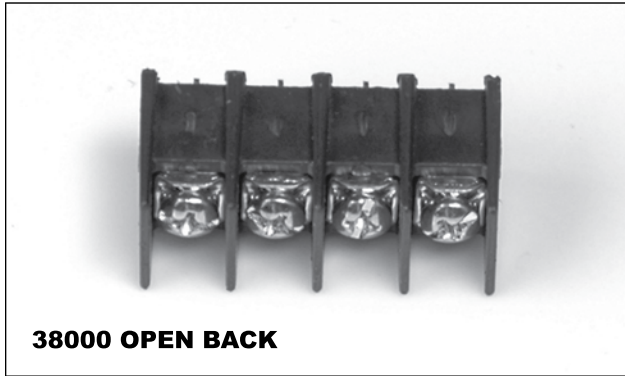

**38000 OPEN BACK**

## Features:

- Complete line of .375" centerline terminal block styles. Terminal blocks come in surface mount, PC mount, panel mount, and feed-thru styles with a wide variety of top and bottom terminations available
- Compliant contact design virtually eliminates solder joint fractures due to pin twist
- Standoffs are molded into blocks to prevent trapping solder flux and to aid in the board cleaning process
- Broad wire range. The 37000/38000 Series terminal blocks will accommodate wire sizes up to 12AWG
- Full line of accessories complements the 37000/38000 Series terminal blocks, offering greater design flexibility
- All Curtis terminal blocks for electronic applications are made from self-extinguishing material rated 94V-0 by Underwriters Laboratories, Inc.
- Customized terminal blocks are available for special application by consulting any authorized Curtis distributor, Curtis representative, or by contacting the Curtis factory direct



Recognized under the Components Program of Underwriters Laboratories, Inc. Standard 1059, Guide No. XCFR2, File No. E62557.

Guide No. 22.2 No. 158, Report No. LR39186-1.

BARRIER STYLE

## SERIES 38000 VARIATIONS

### 1 - Printed Circuit Pin

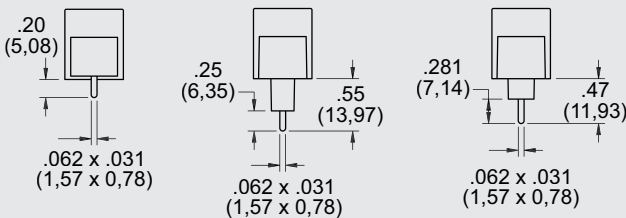

### 2 - Turret Type Solder Terminal

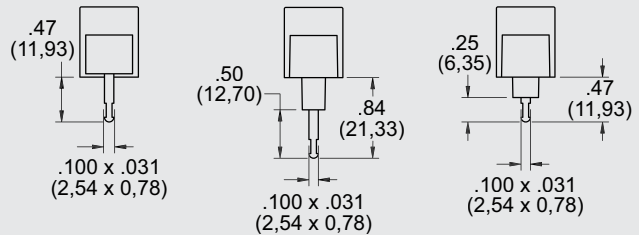

### 3 - .110" Quick Connect

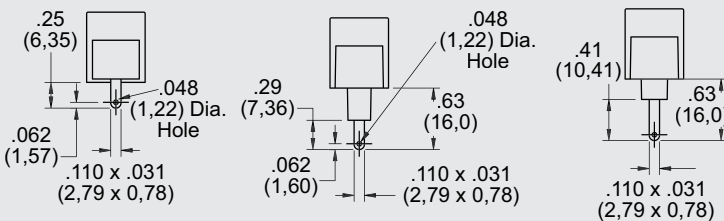

### 4 - .187" Quick Connect

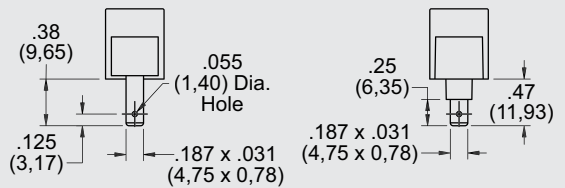

### 5 - .250" Quick Connect

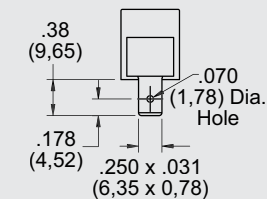

### 6 - Wire Wrap/Printed Circuit Pin

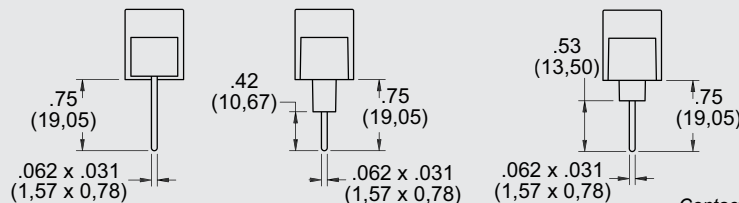

### 7 - Wire Wrap/Right Angle Printed Circuit Pin

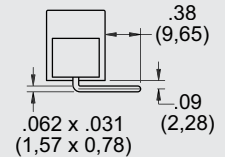

NOTE: Standard bend shown. Contact factory for other bend dimensions.



**Specifications:**

**Center-to-Center Spacing:** .375"  
(9.52mm)

**Wire Range:** No. 22AWG to No. 12AWG

**No. of Terminals:** 1 thru 26 (28 positions on surface mount without mounting ends)

**Voltage Rating:** 300V

**Tightening Torque:**

- Wire Binding Screw 9 in.-lb.
- Wire Clamp 9 in.-lb.

**Current Rating:** 20 amps

**Housing:**

- Material Polypropylene
- Continuous Use
- Temp. (UL Index) 105°C
- Flammability Rating 94V-0
- Water Absorption (24 hrs. % wt. gain) .03%
- Chemical Resistance Excellent

**Breakdown Voltage:**

- Terminal - Ground 3,000V Typ.
- 4,700 Typ.

**Terminals:** Brass, Tin-plated

Series 37000 and 38000 With Mounting Ends							Without Mounting Ends	
Number of Terminals	Dimensions							
	A ± .031 Overall Dimensions (O.D.)		B ± .031 Mounting Dimensions (M.D.)		C ± .031 Less Mounting Ends		A ± .031 Less Mounting Ends	
	Inches	Metric (mm)	Inches	Metric (mm)	Inches	Metric (mm)	Inches	Metric (mm)
1	1.200	30.48	.750	19.05	.450	11.43	—	—
2	1.575	40.01	1.125	28.58	.825	20.96	.825	20.96
3	1.950	49.53	1.500	38.1	1.200	30.48	1.200	30.48
4	2.325	59.06	1.875	47.63	1.575	40.01	1.575	40.01
5	2.700	68.58	2.250	57.15	1.950	49.53	1.950	49.53
6	3.075	78.11	2.625	66.68	2.325	59.06	2.325	59.06
7	3.450	87.63	3.000	76.2	2.700	68.58	2.700	68.58
8	3.825	97.16	3.375	85.73	3.075	78.11	3.075	78.11
9	4.200	106.68	3.750	95.25	3.450	87.63	3.450	87.63
10	4.575	116.21	4.125	104.78	3.825	97.16	3.825	97.16
11	4.950	125.73	4.500	114.3	4.200	106.68	4.200	106.68
12	5.325	135.26	4.875	123.83	4.575	116.21	4.575	116.21
13	5.700	144.78	5.250	133.35	4.950	125.73	4.950	125.73
14	6.075	154.31	5.625	142.88	5.325	135.26	5.325	135.26
15	6.450	163.83	6.000	152.4	5.700	144.78	5.700	144.78
16	6.825	173.36	6.375	161.93	6.075	154.31	6.075	154.31
17	7.200	182.88	6.750	171.45	6.450	163.83	6.450	163.83
18	7.575	192.41	7.125	180.98	6.825	173.36	6.825	173.36
19	7.950	201.93	7.500	190.5	7.200	182.88	7.200	182.88
20	8.325	211.48	7.875	200.03	7.575	192.41	7.575	192.41
21	8.700	220.98	8.250	209.55	7.950	201.93	7.950	201.93
22	9.075	230.51	8.625	219.08	8.325	211.46	8.325	211.46
23	9.450	240.03	9.000	228.6	8.700	220.98	8.700	220.98
24	9.825	249.56	9.375	238.13	9.075	230.51	9.075	230.51
25	10.200	259.08	9.750	247.65	9.450	240.03	9.450	240.03
26	10.575	268.61	10.125	257.18	9.825	249.56	9.825	249.56
27							10.200	259.08
28							10.575	268.61

Dimensions shown are ± 0.030"

**SERIES 37000 VARIATIONS**

**1 – Printed Circuit Pin**

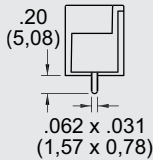

**2 – Turret Type Solder Terminal**

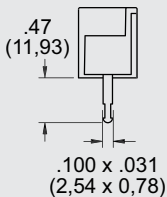

**3 – .110" Quick Connect**

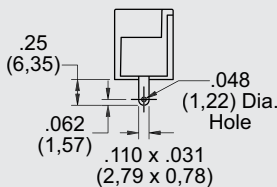

**4 – .187" Quick Connect**

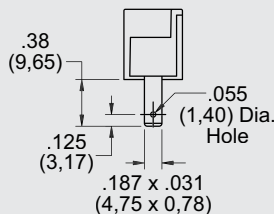

**5 – .250" Quick Connect**

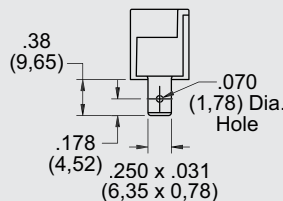

**6 – Wire Wrap/Printed Circuit Pin**

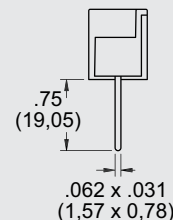

**7 – Wire Wrap/Right Angle Printed Circuit Pin**

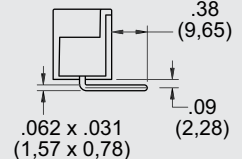

Dimensions are in inches and millimeters unless otherwise specified. Values in parentheses are metric equivalents.





# Series 37000/38000

## Series 37000 Surface Mount with Mounting Ends

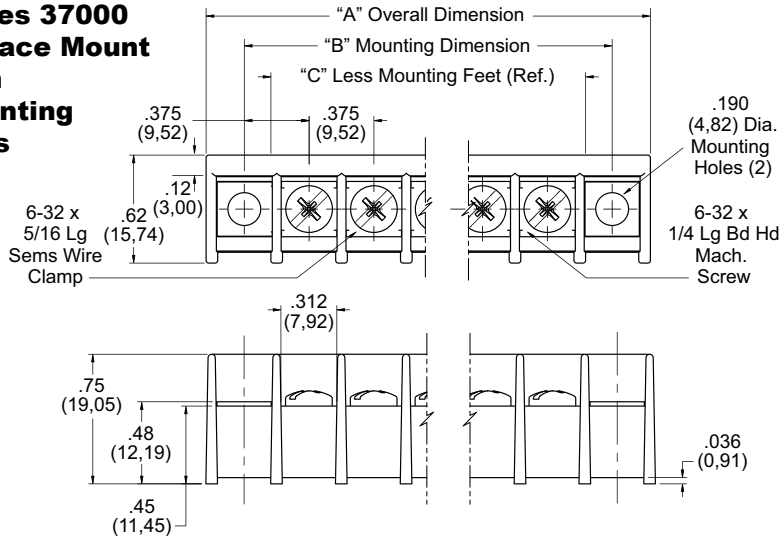

## Series 37000 Surface Mount without Mounting Ends

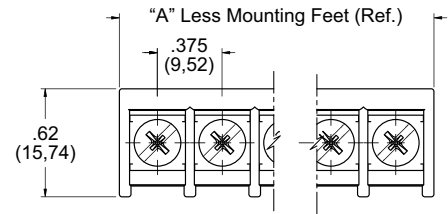

Single Row

BARRIER STYLE

## How to Order T37 X X X XX X

### MOLDING DESIGN

- 0 = Surface Mount w/ Mounting Ends
- 1 = Surface Mount w/o Mounting Ends

### INSERT OR BOTTOM

#### TERMINATION DESIGN

- 0 = Surface Mount, No Bottom Termination
- 1 = Printed Circuit Pin
- 2 = Turret Type Solder Terminal
- 3 = Quick Connect .110"
- 4 = Quick Connect .187"
- 5 = Quick Connect .250"
- 6 = Wire Wrap Pin
- 7 = Right Angle Printed Circuit

### SPECIALS OR OPTIONAL DESIGNS

- 0 = None
- A-Z = Custom Configuration

### NUMBER OF POSITIONS

- 1 thru 26, Available in One to Twenty-Six Positions (28 Surface Mounts without Mounting Ends)

### HARDWARE OR TOP TERMINATION DESIGN

- 0 = Nickel Plated Steel Screw, Standard
- 1 = Wire Clamp Screws
- 2 = Nickel Plated Brass Screws
- 3 = Stainless Steel Screws
- 5 = Without Screws
- 6 = Quick Connects, Screw Type\*
- 8 = Captivated Screw

## PC BOARD DRILLING DIMENSIONS

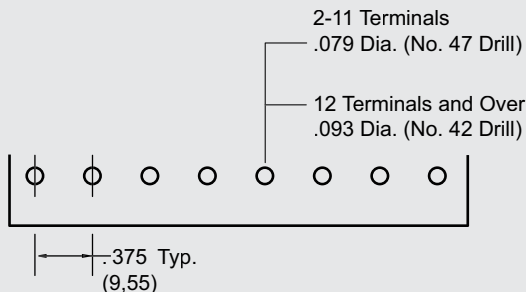

## RECOMMENDED PANEL CUTOUT DIMENSIONS

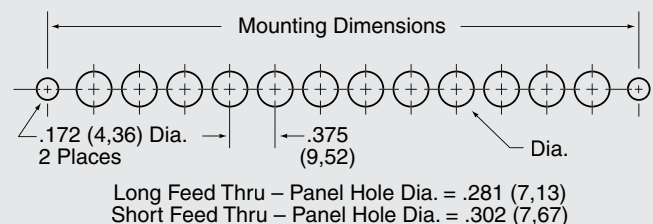

**Series 38000 Surface Mount without Mounting Ends**

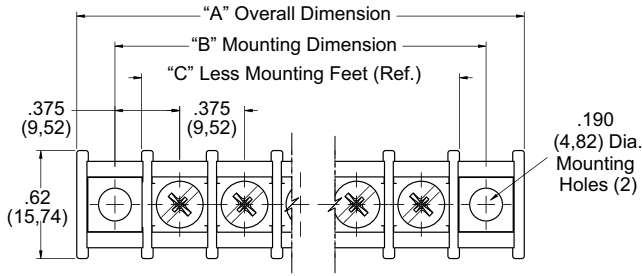

**Series 38000 Short Feed-Thru**

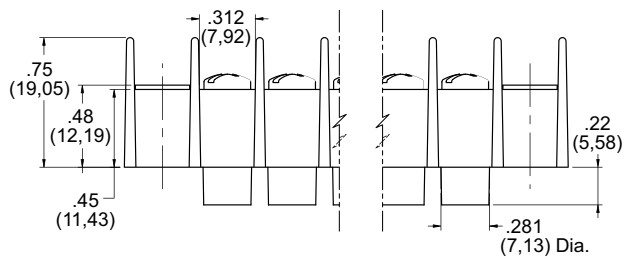

**Series 38000 Base Mount**

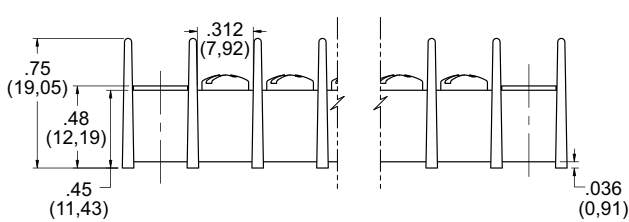

**Series 38000 Long Feed-Thru**

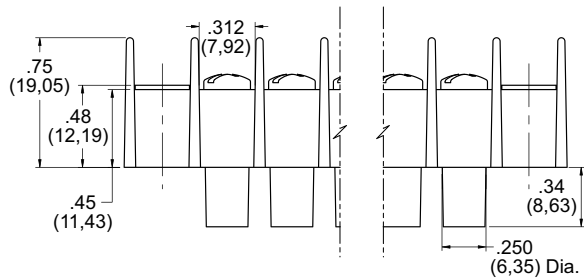

**How to Order** T38 X X X XX X

**MOLDING DESIGN**

- 0 = Surface Mount w/ Mounting Ends
- 1 = Surface Mount w/o Mounting Ends
- 2 = Insulated Feed Thru .250 Diameter w/ Mounting Ends
- 3 = Insulated Feed Thru .250 Diameter w/o Mounting Ends
- 4 = Insulated Feed Thru .281 Diameter w/ Mounting Ends
- 5 = Insulated Feed Thru .281 Diameter w/o Mounting Ends

**INSERT OR BOTTOM TERMINATION DESIGN**

- 0 = Surface Mount, No Bottom Termination
- 1 = Printed Circuit Pin
- 2 = Turret Type Solder Terminal
- 3 = Quick Connect .110"
- 4 = Quick Connect .187"
- 5 = Quick Connect .250"
- 6 = Wire Wrap Pin
- 7 = Right Angle Printed Circuit

**SPECIALS OR OPTIONAL DESIGNS**

- 0 = None
- A-Z = Custom Configuration

**NUMBER OF POSITIONS**

1 thru 26, Available in One to Twenty-Six Positions (28 Surface Mounts without Mounting Ends)

**HARDWARE OR TOP TERMINATION DESIGN**

- 0 = Nickel Plated Steel Screw, Standard
- 1 = Wire Clamp Screws
- 2 = Nickel Plated Brass Screws
- 3 = Stainless Steel Screws
- 5 = Without Screws
- 6 = Quick Connects, Screw Type\*
- 8 = Captivated Screw

**RECOMMENDED PANEL CUTOUT DIMENSIONS**

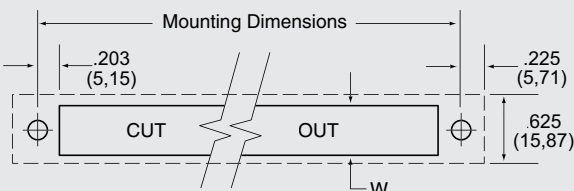

**SURFACE MOUNT STYLES**

- .187 (4,75) Tab W = .45 (11,34)
- .250 (6,35) Tab
- .110 (2,79) QC Wire Wrap Solder Tab W = .38 (9,65)



# Series 37000/38000

## Series 37000 Accessories

### QUICK-CONNECT TERMINALS .020 X .187

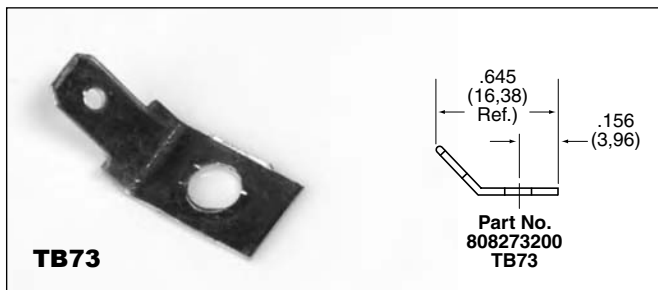
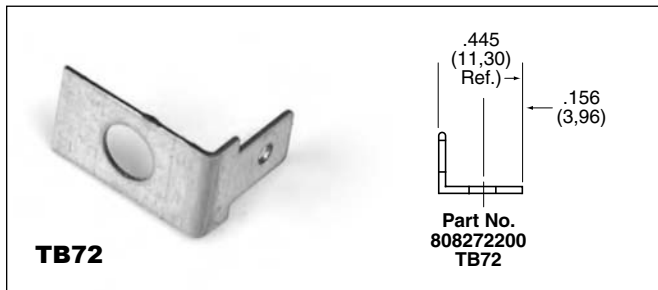
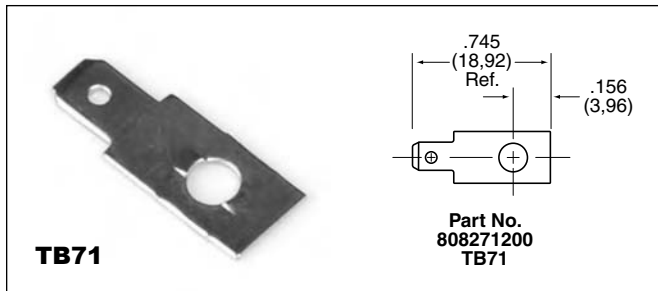

## Series 37000/38000 Accessories

### TERMINAL BLOCK JUMPERS

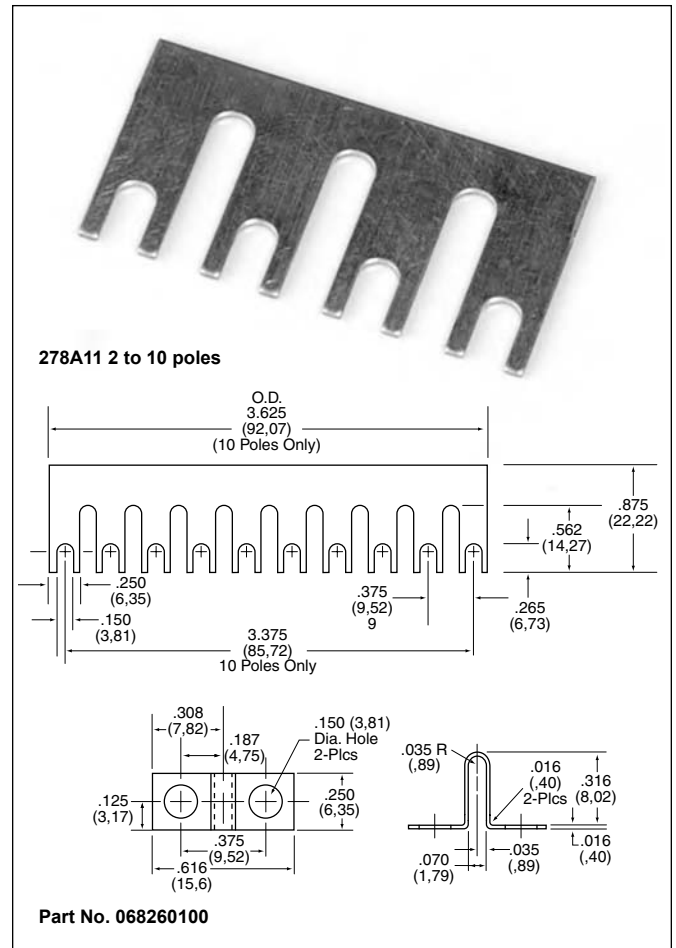

Single Row

BARRIER STYLE

### MARKING STRIPS

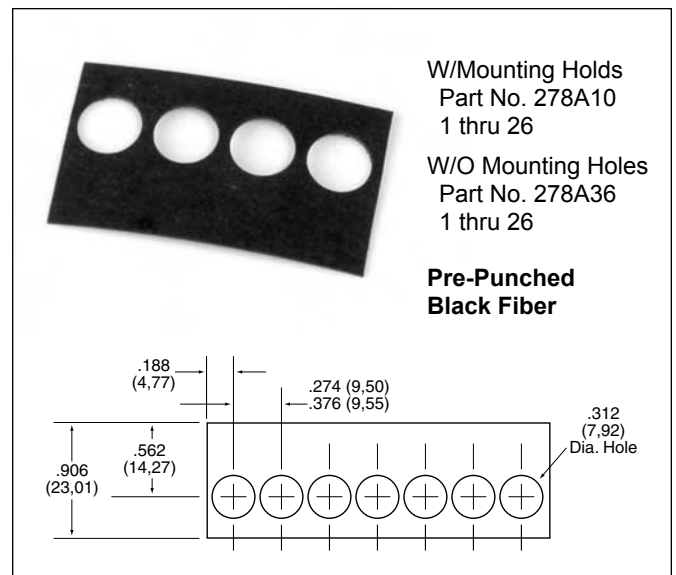



**Series 38000 Accessories**

**QUICK-CONNECT TERMINALS .020 x .187"**

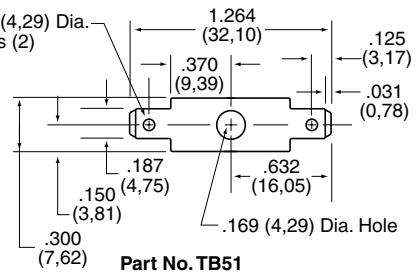
**TB51** Part No. TB51



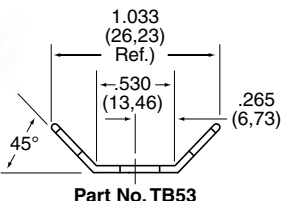

**TB52** Part No. TB52

**TB53** Part No. TB53

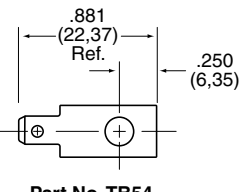
**TB54** Part No. TB54



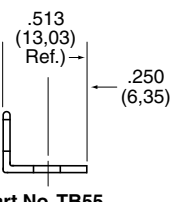

**TB55** Part No. TB55

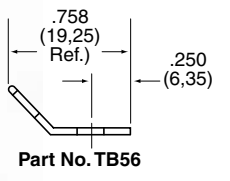
**TB56** Part No. TB56

**TINNERMAN NUTS**

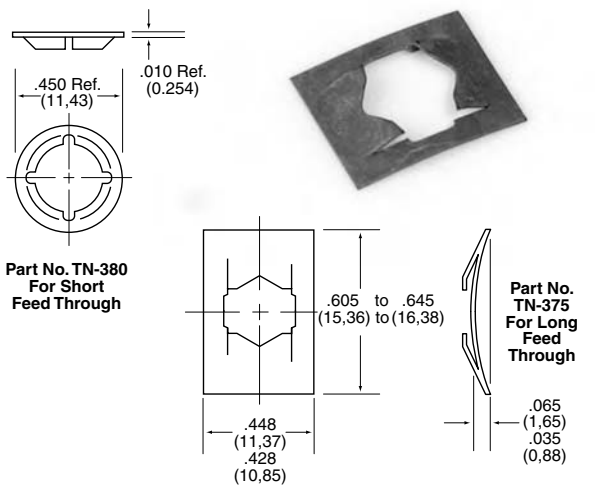
Part No. TN-380 For Short Feed Through

Part No. TN-375 For Long Feed Through

**COVERS**

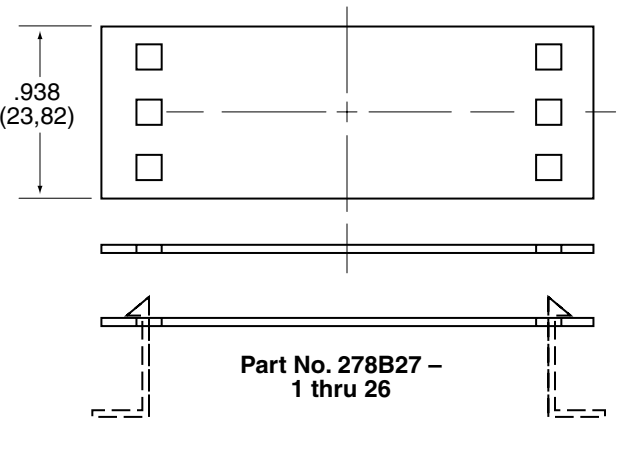

Part No. 278B27 - 1 thru 26

Single Row BARRIER STYLE

Dimensions are in inches and millimeters unless otherwise specified. Values in parentheses are metric equivalents.

# Series CB/CFT .375" (7/8") 9.52mm Center-to-Center Spacing

Single Row

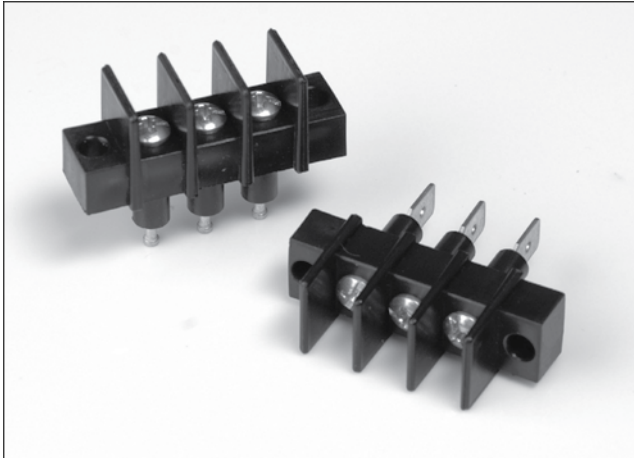
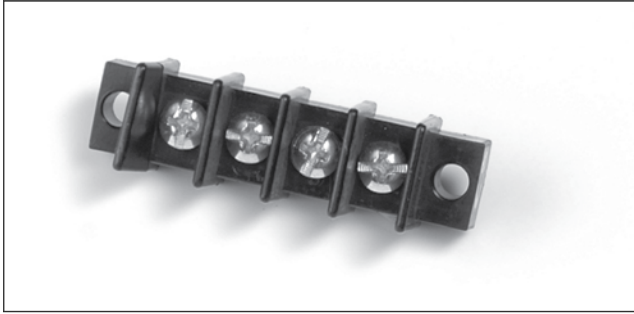

## Features:

- **Compact Barrier-Type Design** – Especially suited for electronic and control feed-thru applications where space saving is required
- **Fully Insulated Feed-Thru, Disconnect, Printed Circuit or Surface Connection** – One thru 26 terminals on .375" center-to-center spacing
- **Improved High Barrier-Type Design** – Meets industrial control clearance and creepage requirements set by UL. Rated 20A up to 600V
- **Suitable for High Moisture and Dust Environments** – Blocks are made of break resistance, high-impact black thermoplastic
- **Solid Construction** – Terminals are molded in place with precision screw machined brass inserts which will not twist. Virtually eliminating broken solder joints while providing a full mechanical thread system
- **Broad Wire Range** – No. 6-32 external terminal screw UL recognized for No. 22AWG to No. 12AWG
- **Recognition and Listing** – UL recognized and CSA certified



Recognized under the Components Program of Underwriters Laboratories, Inc. Standard 1059, Guide No. XCFR2, File No. E62557.



Guide No. 22.2 No. 158, Report No. LR39186-1. Complies with IEC 947-7-1

BARRIER STYLE

## SERIES CB/CFT VARIATIONS

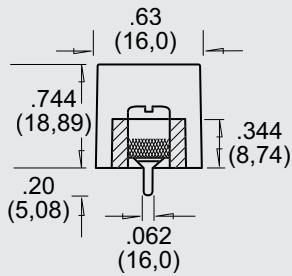

**CBP**  
.062" dia.  
printed  
circuit pin

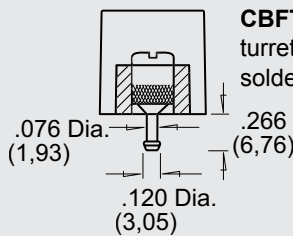

**CBFT**  
turret-type  
solder pin

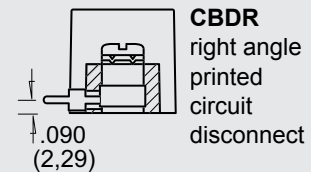

**CBDR**  
right angle  
printed  
circuit  
disconnect

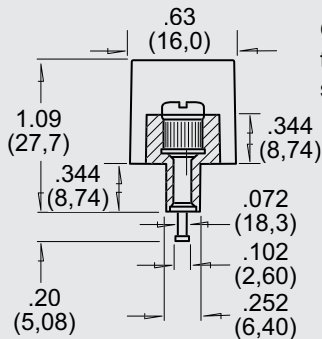

**CFT**  
turret-type  
solder pin

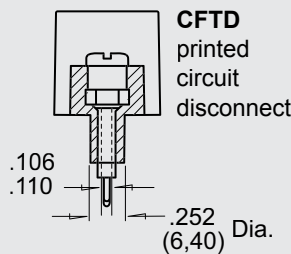

**CFTD**  
printed  
circuit  
disconnect

CFTD is normally supplied with standard pin installed.

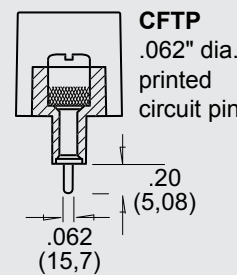

**CFTP**  
.062" dia.  
printed  
circuit pin

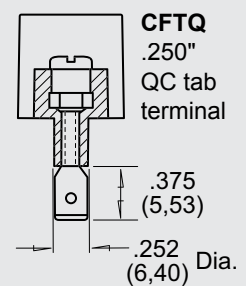

**CFTQ**  
.250"  
QC tab  
terminal

NOTE: Consult factory for minimums



**Specifications:****Center-to-Center Spacing:** .375" (9.52mm)**Wire Range:** No. 22AWG to No. 12AWG**No. of Terminals:** 1 thru 26**Voltage Rating:** CSA – 300V*Screw Terminals:*

UL – 600V – Limited Energy Devices

UL – 300V – General Industrial

*Quick Connects:*

UL – 125V – General Appliance

**Tightening Torque:**

Wire Binding Screw 12 in.-lb.

Wire Clamps 20 in.-lb.

**Current Rating:** 20 amps**Housing:**

Material Thermoplastic Polyester

Continuous Use

Temp. (UL Index) 140°C (284°F)

Flammability Rating 94V-0

Water Absorption

(24 hrs. % wt. gain) .08%

Chemical Resistance Excellent in most environments

**Breakdown Voltage:**

Terminal - Terminal 7,000V Typ.

Terminal - Ground 6,000V Typ.

**Terminals:** Solid Brass

Solder style terminals are plated with high-purity tin for optimum solderability

**Contact Resistance:** .002 Ohm Typ. – CFTD**INTERNAL TERMINAL DESIGNATIONS**

CBP printed circuit board design with .062" diameter tin-plated brass pin

CBFT tin-plated brass turret-type solder pin

CFT tin-plated brass turret-type solder pin

CFTP printed circuit board design with .062" diameter tin-plated brass pin

CFTQ .250" quick connect tab terminal

CFTD disconnect design with factory installed pin terminals for printed circuit mounting

CBDR right angle disconnect design

**EXTERNAL TERMINAL DESIGNATIONS**

CBP, CBFT, CFT, screw terminal with No. 6-32 plated steel\* screw accepting wire up to No. 12AWG

CBPW, CFTW, 6-32 combo head screw with captivated traveling wire clamp  
CBFTW, CFTPW,  
CFTQW, CFTDW,  
CBDRW

\* Other materials available – contact factory or your local representative for additional information.

Number of Terminals	Series CB/CFT With Mounting Ends				Without Mounting Ends	
	Dimensions					
	A ± .031 Overall Dimensions (O.D.)		B ± .031 Mounting Dimensions (M.D.)		C ± .031 Less Mounting Positions	
	Inches	Metric (mm)	Inches	Metric (mm)	Inches	Metric (mm)
1	.750	19.05	1.062	26.98	.437	11.11
2	1.125	28.57	1.437	36.51	.812	20.63
3	1.500	38.10	1.812	46.03	1.187	30.16
4	1.875	47.62	2.187	55.56	1.562	39.68
5	2.250	57.15	2.562	65.08	1.937	49.21
6	2.625	66.67	2.937	74.61	2.312	58.73
7	3.000	76.20	3.312	84.13	2.687	68.26
8	3.375	85.72	3.687	93.66	3.062	77.78
9	3.750	95.25	4.062	103.18	3.437	87.31
10	4.125	104.77	4.437	112.71	3.812	96.83
11	4.500	114.30	4.812	122.23	4.187	106.36
12	4.875	123.82	5.187	131.76	4.562	115.88
13	5.250	133.35	5.562	141.28	4.937	125.41
14	5.625	142.87	5.937	150.81	5.312	134.93
15	6.000	152.40	6.312	160.33	5.687	144.46
16	6.375	161.92	6.687	169.86	6.062	153.98
17	6.750	171.45	7.062	179.38	6.437	163.51
18	7.125	180.97	7.437	188.91	6.812	173.03
19	7.500	190.50	7.812	198.43	7.187	182.56
20	7.875	200.02	8.187	207.96	7.562	192.08
21	8.250	209.55	8.562	217.48	7.937	201.61
22	8.625	219.07	8.937	227.01	8.312	211.13
23	9.000	228.60	9.312	236.53	8.687	220.66
24	9.375	238.12	9.687	246.06	9.062	230.18
25	9.750	247.65	10.062	255.58	9.437	239.71
26	10.125	257.17	10.437	265.11	9.812	249.23

Dimensions shown are ± 0.030"

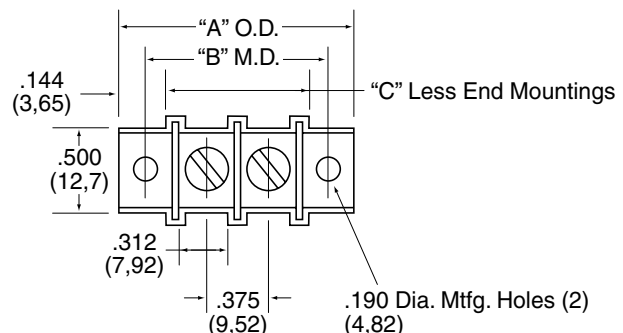
**Series CB/CFT Dimensions**

## How to Order

CFT Series terminal blocks are ordered by listing designation followed by the number of poles required for the application. Example: Type CFT 10-pole block becomes stock number CFT-10.

Suffixes are used as follows:

- W denotes model with wire clamp replacing external screw terminal
- C denotes model less mounting positions

To specify quick-connect terminals, simply add the style number required.

May be purchased factory-assembled or as customer-installed accessory.

The CFT-10 described above with wire clamp less mounting positions thus converts to stock number CFTWC-10.

## PC BOARD DRILLING DIMENSIONS

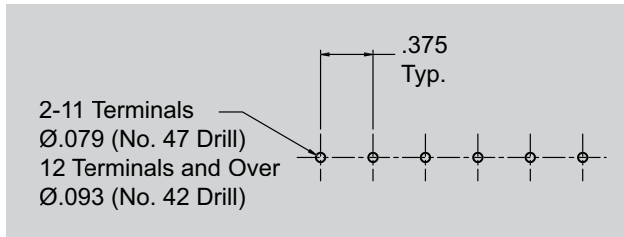

## Series CB/CFT Accessories

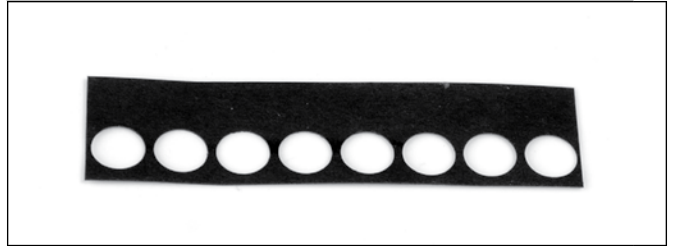

### MARKING STRIPS

CB/CFT – Pre-punched black fiber . . . mounts under block. May be imprinted to customer specifications.

To order, specify: Part No. 278A10-1 thru 26 (with mounting hole); Part No. 278A36-1 thru 26 (less mounting hole).

### COVERS

CB/CFT – Rigid .030" thick self-extinguishing vinyl. Black matte-finished on both sides. May double as marking strip when imprinted with white ink. Complete with spring clips for attaching to mounting positions.

Part No. 278B27-1 thru 26 terminals

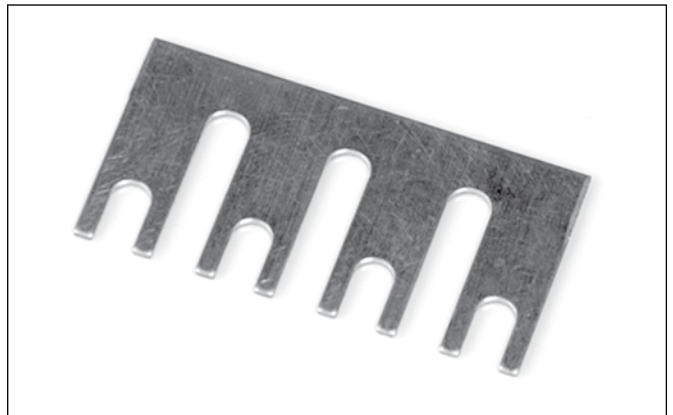

### TERMINAL BLOCK JUMPERS

CB/CFT – Jumper is constructed of plated brass. "Rooster comb" design permits connections of two to 10 poles.

To order, specify; Part No. 278-A11 (plus no. of poles)

Example: 278-A11-10, 10 Pole Jumper

### WIRE CLAMP

CB/CFT – Wire clamp captivated to No. 6-32 screw eliminates need for lugs. Accepts No. 14AWG wire. Part No. 58523700

Terminal blocks are normally supplied with No. 6-32 combo head screws. Other styles and materials on special order.



## QUICK-CONNECT TERMINALS

CB/CFT – Available with .187" x .020" quick-connect tabs of tin-plated brass, held in place by terminal screws. Six styles . . . one to six terminations per pole. Factory-assembled or customer installed. Last digit of part number corresponds to previous style numbers.

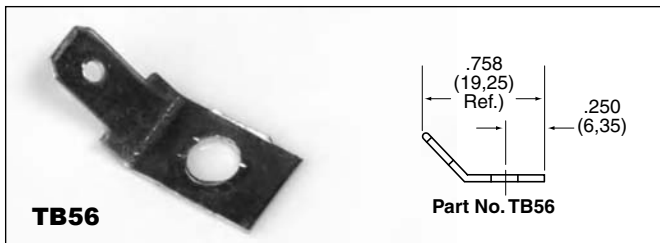
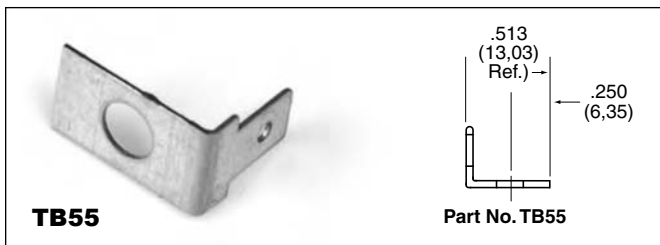
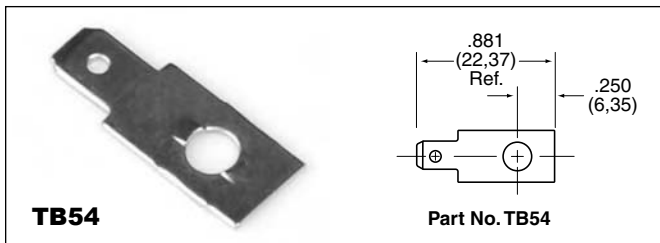
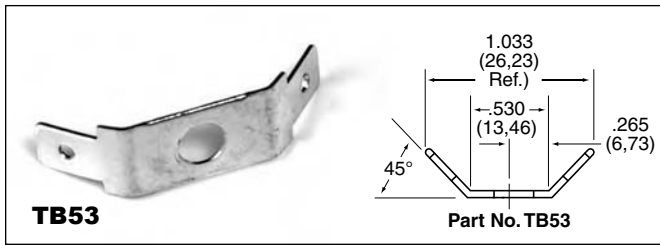
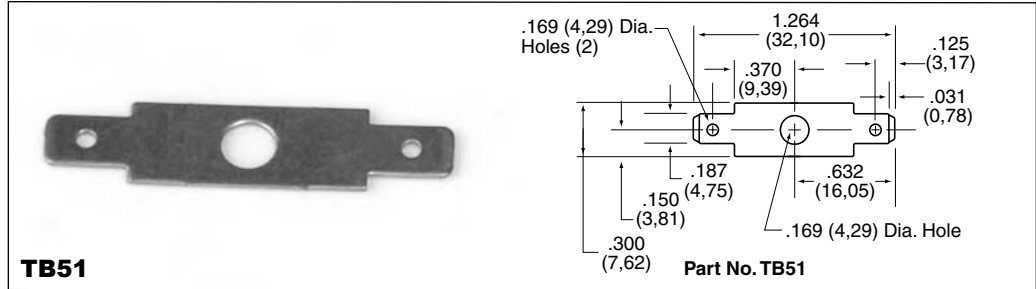

## TINNERMAN NUT

CFT – for speed mounting of terminal blocks less mounting position.  
Part No. TN-375.

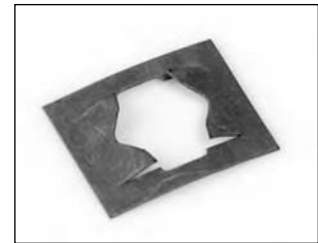

Single Row

BARRIER STYLE





# Series 43000 .4375" (11.11mm) Center-to-Center Spacing

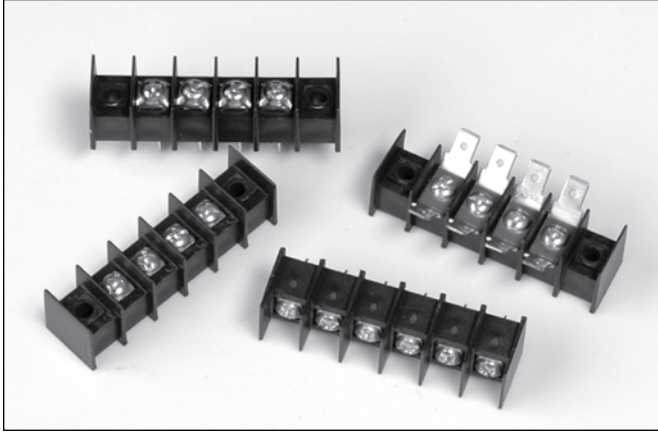

## Features:

- Cost-competitive line of .4375" (11.11mm) centerline terminal blocks provides design engineers with multitude of selection choices: base mount and feed thru styles with P.C. pin, turret, quick connect, wire wrap and right angle.
- Available in up to 28 positions.
- Rated up to 30A, 600V
- Accepts very broad wire range from 22AWG to 12 AWG. Variety to top terminations including 6-32 and 8-32 screws, quick connects, wire clamps, jumpers, and covers.
- Unique Curtis contact design helps eliminate fracturing of solder joint due to pin twist.
- Plated brass inserts are standard on all Series 43000 terminal blocks. Standoffs molded into the blocks inhibit the trapping of solder flux – makes it easier to clean boards.
- All terminal blocks for electronic use are made from highly durable, self-extinguishing polypropylene material rated 94 V-0 by Underwriters Laboratories, Inc.
- Custom built terminal blocks for special applications are available. Contact any authorized Curtis distributor or representative, or call the factory direct.

Single Row

 Recognized under the Components Program of Underwriters Laboratories, Inc. Standard 1059, Guide No. XCFR2, File No. E62557.

 Guide No. 22.2 No. 158, Report No. LR39186-1.

BARRIER STYLE

## Series 43000 Variations

0 – Flush Mount

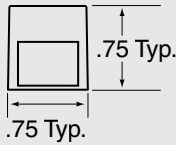

1 – Printed Circuit Pin

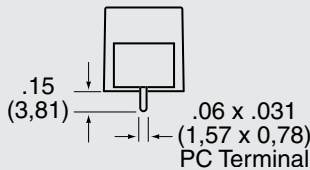

2 – Turret Type Solder Terminal

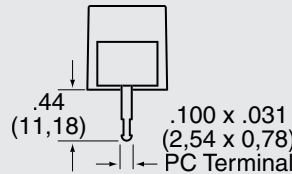

3 – Quick Connect .110"

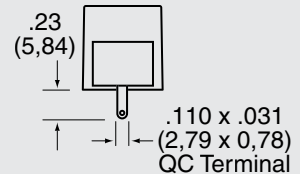

4 – Quick Connect .187"

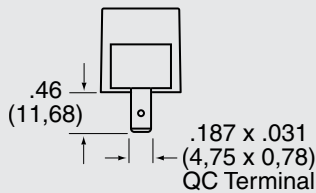

5 – Quick Connect .250"

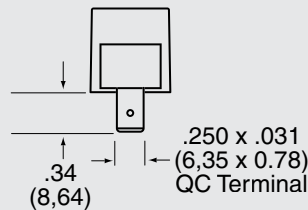

6 – Wire Wrap Pin

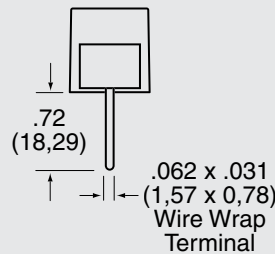

7 – Right Angle Printed Circuit Pin

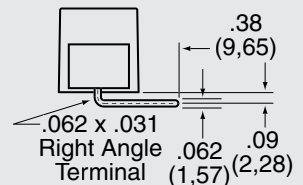

1 – Printed Circuit Pin

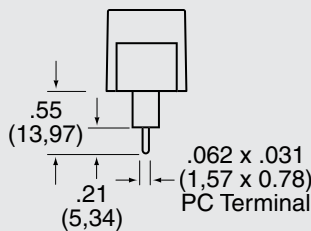

2 – Turret Type Solder Terminal

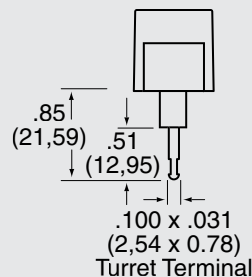

3 – Quick Connect .110"

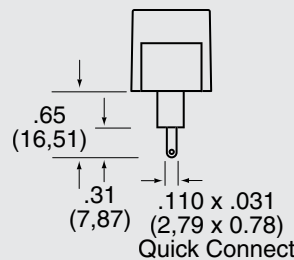

6 – Wire Wrap Pin (extended pc pin)

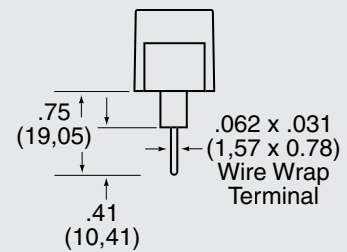

**Specifications:**

**Center-to-Center Spacing:** .4375" (11.11mm)

**Wire Range:** No. 22AWG to 12AWG

**No. of Terminals:** 1 thru 26 (28 without mounting holes)

**Voltage Rating:** 600V

**Tightening Torque:** 9 in. lb.

**Current Rating:** 20 amps UL  
(30 Amps with 10AWG & Lugs)

**Housing:**

Material Polypropylene  
 Continuous Use Temp. (UL Index) 105°C (221°F)  
 Flammability Rating 94V-0  
 Water Absorption (24 hrs. % wt. gain) .03%

**Breakdown Voltage:**

Terminal - Terminal 3000V  
 Terminal - Ground 3000V

**Terminals:** Brass - Tin Plated

**Series 43000 Surface Mount With Mounting Ends**

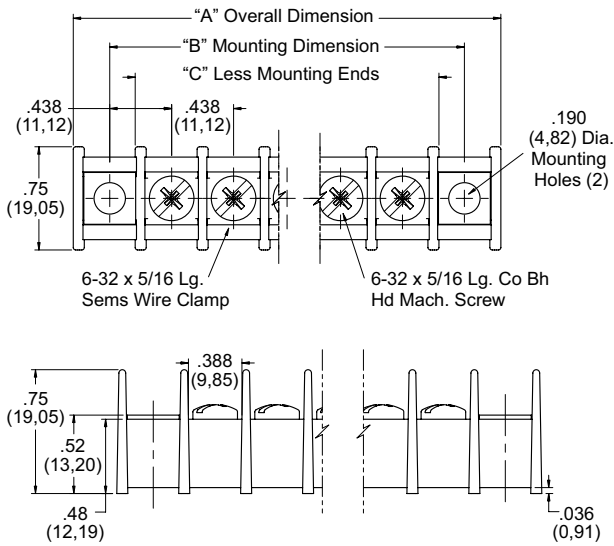

Number of Terminals	Series 43000 With Mounting Ends				Without Mounting Ends	
	Dimensions					
	A ± .031 Overall Dimensions (O.D.)		B ± .031 Mounting Dimensions (M.D.)		C ± .031 Less Mounting Positions	
	Inches	Metric (mm)	Inches	Metric (mm)	Inches	Metric (mm)
1	1.375	34.93	.875	22.23	.500	12.70
2	1.813	46.05	1.313	33.35	.938	23.83
3	2.250	57.15	1.750	44.45	1.375	34.93
4	2.688	68.28	2.188	55.58	1.813	46.05
5	3.125	79.38	2.625	66.68	2.250	57.15
6	3.563	90.50	3.063	77.80	2.688	68.28
7	4.000	101.60	3.500	88.90	3.125	79.38
8	4.438	112.73	3.938	100.03	3.563	90.50
9	4.875	123.83	4.375	111.13	4.000	101.60
10	5.313	134.95	4.813	122.25	4.438	112.73
11	5.750	146.05	5.250	133.35	4.875	123.83
12	6.188	157.18	5.688	144.48	5.313	134.95
13	6.625	168.28	6.125	155.58	5.750	146.05
14	7.063	179.40	6.563	166.70	6.188	157.18
15	7.500	190.50	7.000	177.80	6.625	168.28
16	7.938	201.63	7.438	188.93	7.063	179.40
17	8.375	212.73	7.875	200.03	7.500	190.50
18	8.813	223.85	8.313	211.15	7.938	201.63
19	9.250	235.00	8.750	222.25	8.375	212.73
20	9.688	246.08	9.188	233.38	8.813	223.85
21	10.125	257.18	9.625	244.48	9.250	234.95
22	10.563	268.30	10.063	255.60	9.688	246.08
23	11.000	279.4	10.500	266.70	10.125	257.18
24	11.438	290.53	10.938	277.83	10.563	268.30
25	11.875	301.63	11.375	288.93	11.000	279.40
26	12.313	312.75	11.813	300.05	11.438	290.53
27					11.875	301.63
28					12.313	312.75

Dimensions shown are ± 0.030"

**43000 Feed-Thru Series**

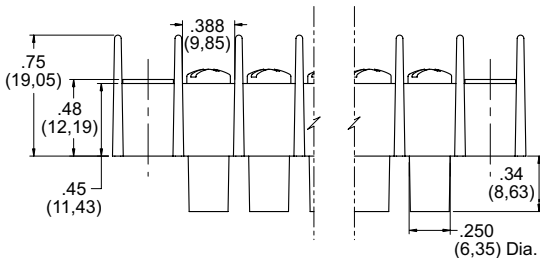

Dimensions are in inches and millimeters unless otherwise specified. Values in parentheses are metric equivalents.



**Curtis Industries**  
A Division of Powers Holdings, Inc.

# Series 43000

## How to Order

43 X X X X XX X

### MOLDING DESIGN

- 0 = Surface Mount w/ Mounting Ends
- 1 = Surface Mount w/o Mounting Ends
- 2 = Insulated Feed Thru w/ Mounting Ends
- 3 = Insulated Feed Thru w/o Mounting Ends

### INSERT OR BOTTOM TERMINATION DESIGN

- 0 = Surface Mount, No Bottom Termination
- 1 = Printed Circuit Pin
- 2 = Turret Type Solder Terminal
- 3 = Quick Connect .110"
- 4 = Quick Connect .187"
- 5 = Quick Connect .250"
- 6 = Extended Printed Circuit Pin or Wire Wrap
- 7 = Right Angle Printed Circuit Pin

Note: Option 4 & 5 Only Available on Surface Mount Style Molding

### INSERT/SCREW DIMENSION

- 0 = 6-32 Insert and Screw
- 1 = 8-32 Insert and Screw, available on PC Pin, Turret Type Solder Pins, Wire Wrap and Right Angle Versions only

### SPECIALS OR OPTIONAL DESIGNS

- 0 = None
- A-Z = Custom Configuration

### NUMBER OF POSITIONS

Available 1 thru 26 W/Mounting End  
1 thru 28 w/o Mounting Ends

### HARDWARE OR TOP TERMINATION DESIGN

- 0 = Standard Zinc Plated Steel Screw, Combo Head
- 1 = Wire Clamp Screw
- 2 = Nickel Plated Brass Screw
- 3 = Stainless Steel Screw
- 5 = Without Screws
- 6 = Quick Connects, Screw Type\*
- 8 = Captivated Screw

\*See accessories

Single Row

BARRIER STYLE

## Series 43000 Accessories

### WIRE CLAMP

4300 – Wire clamp captivated to No. 6-32 or 8-32 screw eliminates need for lugs. Accepts up to No. 12AWG wire. May be ordered factory installed or loose.

### MARKING STRIPS

4300 – Pre-punched black fiber . . . mounts under block. May be imprinted to customer specifications.  
To order, specify: Part No. 267A19-1 thru 26 (with mounting hole); Part No. 267A218-1 thru 28 (less mounting hole).

### COVERS

43000 – Rigid .030" thick self-extinguishing vinyl. Black matte-finished on both sides. May double as marking strip when imprinted with white ink. Complete with spring clips for attaching to mounting positions.

Part No. 0196\_\_000, 1 thru 26 poles.

Example: 019605000 would be a 5 pole cover

### TINNERMAN NUT

4300 – for special mounting of terminal blocks less mounting position.

Part No. TN-375.

## TERMINAL BLOCK JUMPERS

4300 – Plated brass "Rooster comb" design Type 267A42 permits connections of two to 18 poles.

To order, specify; Part No. 267A42-\_\_ .

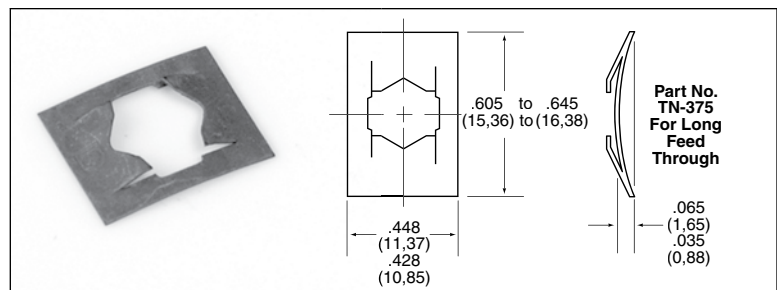
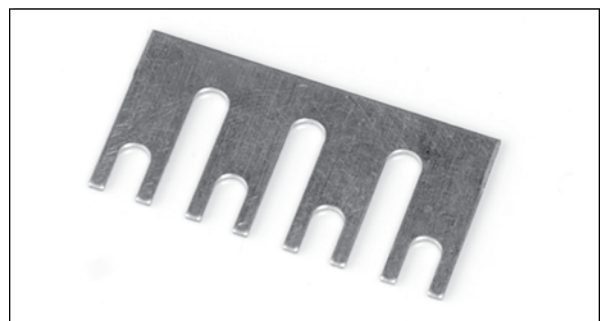

## QUICK-CONNECT TERMINALS QUICK-CONNECT TERMINALS

43000 – Available with .250" x .032" quick-connect tabs of tin-plated brass, held in place by terminal screws. Six styles . . . one to six terminations per pole. Factory-assembled or supplied bulk.

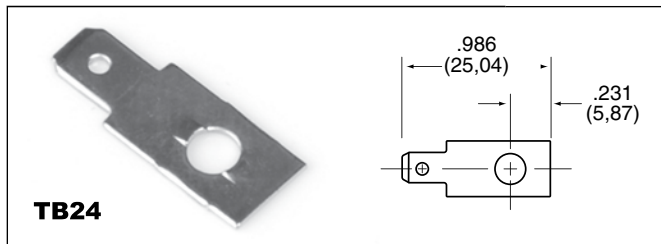
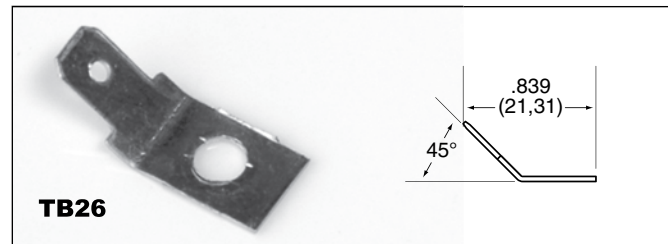
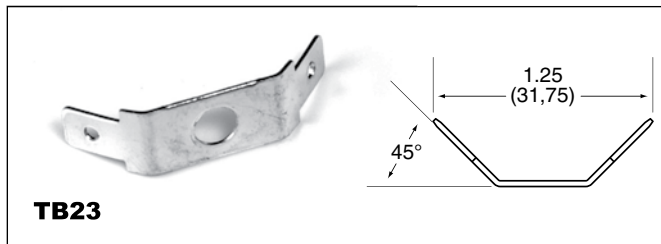
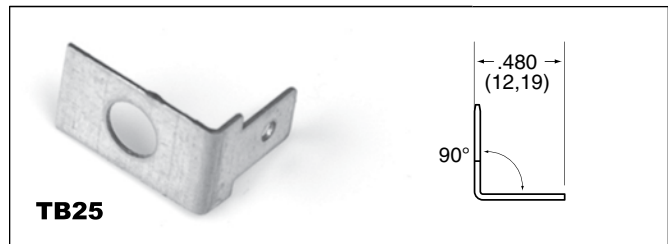
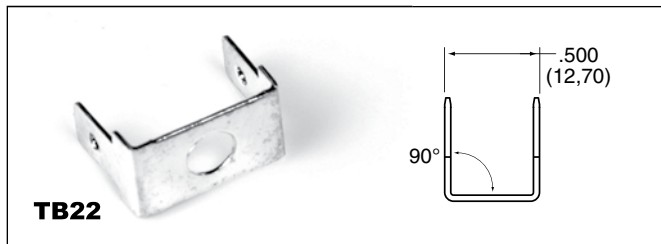
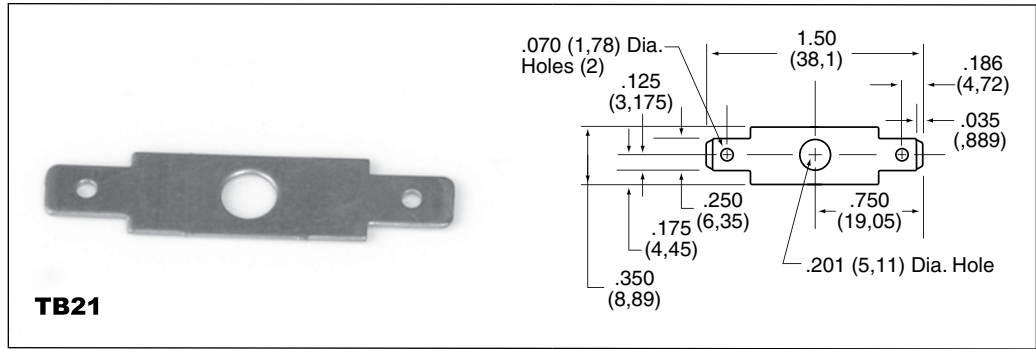

Single Row

BARRIER STYLE

### PC BOARD DRILLING DIMENSIONS

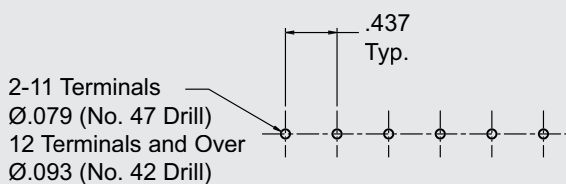

### RECOMMENDED PANEL CUTOUT DIMENSIONS

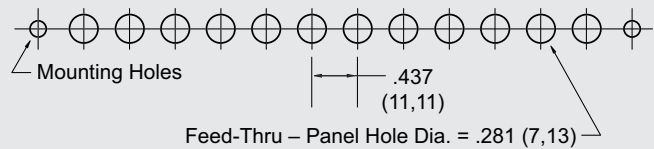

Dimensions are in inches and millimeters unless otherwise specified. Values in parentheses are metric equivalents.



**Curtis Industries**  
A Division of Powers Holdings, Inc.

1-800-657-0853

23

# Series GFT/GB 7/16" (11.11mm) Center-to-Center Spacing

Single Row

BARRIER STYLE

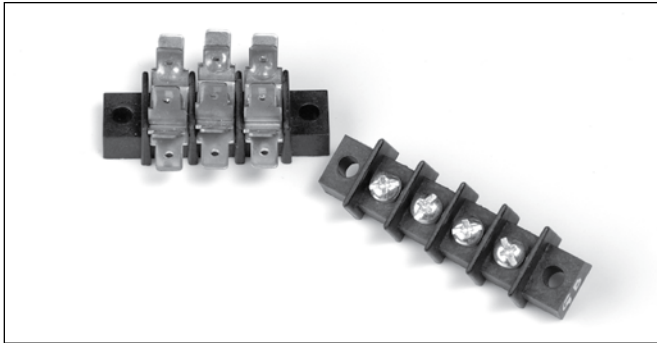
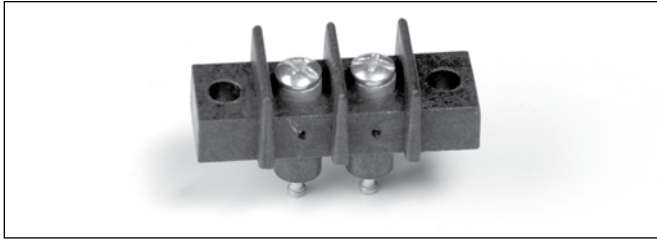

## Series GFT/GB Variations

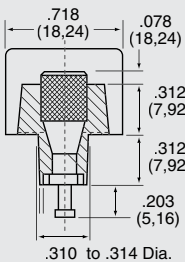

**GTX**  
turret-type  
solder  
pin

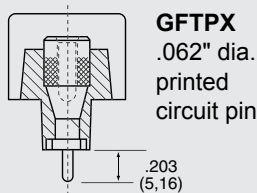

**GFTPX**  
.062" dia.  
printed  
circuit pin

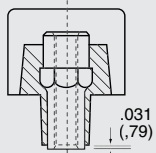

**GFTSX**  
No. 6-32  
machine  
screw

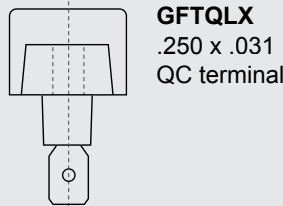

**GFTQLX**  
.250 x .031  
QC terminal

**GBSX**  
closed-back design

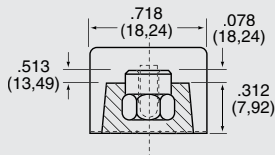

**GBPX**  
.062" dia.  
printed  
circuit pin

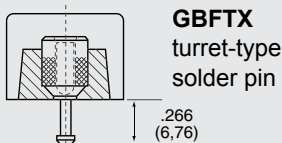

**GBFTX**  
turret-type  
solder pin

## Features:

- **Superior Construction** – All terminals are molded in place with precision screw machined brass inserts which will not twist, virtually eliminating broken solder joints while providing a full mechanical thread system.
- **Ideal for Sub-Chassis or Thru-Panel Application** – No costly insulation or mounting set-up since feed-thru insulators are an integral part of the moldings. Feature provides a full 1/4" terminal to ground clearance even thru 1/16" chassis.
- **Durable Base Material** – Made of black thermo-set phenolic, or high-impact, break-resistant thermoplastic
- **Electrical Rating** – 20A up to 600V
- **Compact Barrier-Type Design** – Especially suited for electronic and control applications
- **Feed-Thru, Printed Circuit or Surface Connection** – One thru 26 terminals on 7/16" center-to-center spacing
- **Broad Wire Range** – UL recognized for No. 22AWG to No. 12AWG, depending on type of external contact designated, with CSA requiring use of lugs on wire larger than No. 16AWG.
- **Terminal Flexibility** – External terminals available in two screw sizes with various internal terminal types
- **Recognition and Listing** – UL recognized and CSA certified



Recognized under the Components Program of Underwriters Laboratories, Inc. Standard 1059, Guide No. XCFR2, File No. E62557.



Guide No. 22.2 No. 158, Report No. LR39186-1.

## INTERNAL TERMINAL DESIGNATIONS

- GFTP** Printed circuit board design with .062" dia. tin-plated brass turret-type solder pin
- GFT** Tin-plated brass turret-type solder pin
- GFTS** Unplated brass insert. No. 6-32 plated steel screw.
- GBS** Unplated brass insert. Closed-back design which can be mounted on metal surface with no additional insulation required.
- GBP** Printed circuit board design with .062" dia. tin plated brass pin.
- GBFT** Tin-plated brass turret-type solder pin.
- GFTQX** .250 x .031 tin-plated brass quick connect tab terminal.

## EXTERNAL TERMINAL DESIGNATIONS

- GBFT, GBP,** Screw terminal with No. 6-32 plated steel\*
- GBS, GFT, GFTP** Screw accepting up to No. 12AWG wire
- GBFTA, GBPA,** Screw terminal with No. 8-32 plated steel\* screw accepting up to No. 12AWG wire
- GBSA, GFTA, GFTSA, GFTPA**

\* Other materials available – contact factory or your local representative for additional information.





**Specifications:**

**Center-to-Center Spacing:** 7/16" (11.11mm)  
**Wire Range:** No. 22AWG to No. 12AWG (CSA requires use of lugs on wire larger than No. 16AWG.)  
**No. of Terminals:** 1 thru 26  
**Voltage Rating:**  
 CSA – 300 volts  
 UL – \*150 volts – General Industrial  
     \*\*250 volts – Commercial Applications  
     300 volts – Limited Energy Applications  
     600 volts – Limited Energy Applications  
 \* GFT, GFTP, GFTS, GFTAL rated for 300 volts.  
 \*\* GFTQALX rated for 125 volts.

**Tightening Torque:**

Wire Binding Screw 9 in.-lb.  
 Wire Clamp 9 in.-lb.

**Current Rating:** 20 amps, UL and CSA

<b>Housing:</b>	<b>Standard</b>	<b>"X" Grade</b>
Material	Phenolic	Polyphenylene Oxide
Continuous Use Temp. (UL Index)	150°C (302°F)	110°C (230°F)
Flammability Rating	94V-0	94V-0
Water Absorption (24 hrs. % wt. gain)	.04%	.06%

<b>Breakdown Voltage:</b>	<b>GFT</b>	<b>GB</b>
Terminal - Terminal	3,600V Typ.	5,000V Typ.
Terminal - Ground	5,800V Typ.	7,900V Typ.

*Note:* Specifications contained herein are subject to change without notice.

**How to Order**

GB/GFT Series terminal blocks are ordered by listing a composite number made up of the model designation followed by the number of poles required for the application. Example: Type GBP 10-pole block becomes stock number GBP-10. Suffixes are used as follows:

- A denotes model with No. 8-32 external screw terminal
- C denotes model less mounting positions
- X denotes model with thermoplastic molding

To specify quick-connect terminals, simply add the style number required. May be purchased factory-assembled or as customer-installed accessory.

The GBP-10 described above – made from thermo-set phenolic – less mounting positions thus converts to sock number GBPC-10.

**PC BOARD DRILLING DIMENSIONS**

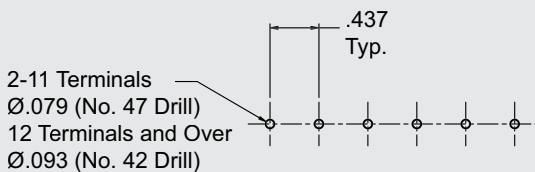

Number of Terminals	Series GFT/GB With Mounting Ends				Without Mounting Ends	
	Dimensions					
	A ± .031 Overall Dimensions (O.D.)		B ± .031 Mounting Dimensions (M.D.)		C ± .031 Less Mounting Positions	
	Inches	Metric (mm)	Inches	Metric (mm)	Inches	Metric (mm)
1	.875	22.22	1.250	31.75	.562	14.28
2	1.312	33.33	1.687	42.86	1.000	25.40
3	1.750	44.45	2.125	53.97	1.437	36.51
4	2.187	55.56	2.562	65.08	1.875	47.62
5	2.625	66.67	3.000	76.20	2.312	58.73
6	3.062	77.78	3.437	87.31	2.750	69.85
7	3.500	88.90	3.875	98.42	3.187	80.96
8	3.937	100.01	4.312	109.53	3.625	92.07
9	4.375	111.12	4.750	120.65	4.062	103.18
10	4.812	122.23	5.187	131.76	4.500	114.30
11	5.250	133.35	5.625	142.87	4.937	125.41
12	5.687	144.46	6.062	153.98	5.375	136.52
13	6.125	155.57	6.500	165.10	5.812	147.63
14	6.562	166.68	6.937	176.21	6.250	158.75
15	7.000	177.80	7.375	187.32	6.687	169.86
16	7.437	188.91	7.812	198.43	7.125	180.97
17	7.875	200.02	8.250	209.55	7.562	192.08
18	8.312	211.13	8.687	220.66	8.000	203.20
19	8.750	222.25	9.125	231.77	8.437	214.31
20	9.187	233.36	9.562	242.88	8.875	225.42
21	9.625	244.47	10.000	254.00	9.312	236.53
22	10.062	255.58	10.437	265.11	9.750	247.65
23	10.500	266.70	10.875	276.22	10.187	258.76
24	10.937	277.81	11.312	287.33	10.625	269.87
25	11.375	288.92	11.750	298.45	11.062	280.98
26	11.812	300.03	12.187	309.56	11.500	292.10

Dimensions shown are ± 0.030"

**Series GFT/GB with Mounting Ends**

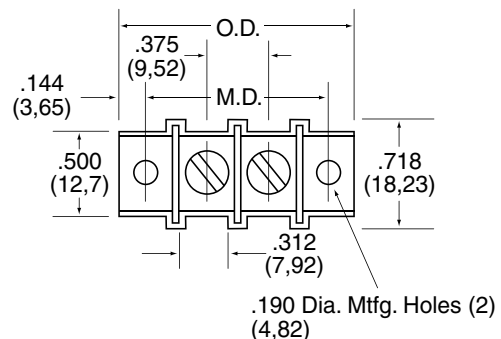

# Series GB/GFT

## Series GFT/GB Accessories

### QUICK-CONNECT TERMINALS

GFT-GFT – Available with .250" x .032" quick-connect tabs of tin-plated brass, held in place by terminal screws. Six styles . . . one to six terminations per pole. Factory-assembled or customer installed. Last digit of part number corresponds to previous style numbers.

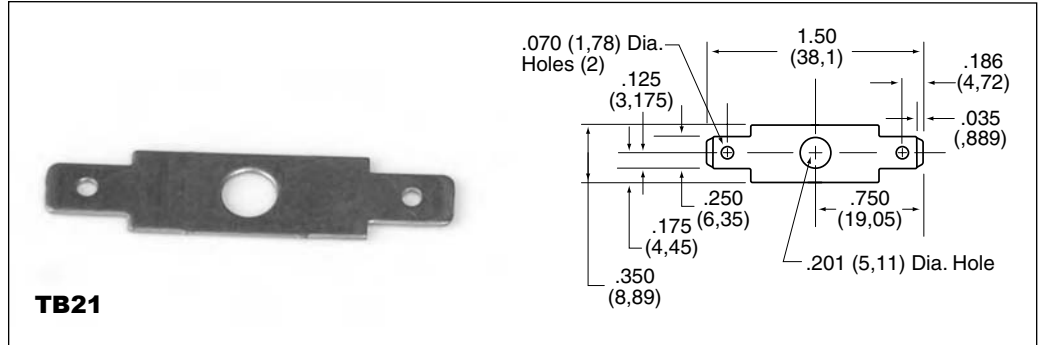

Single Row

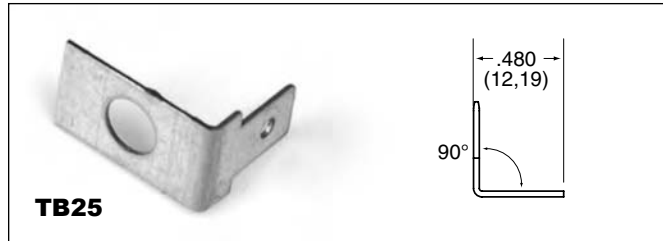
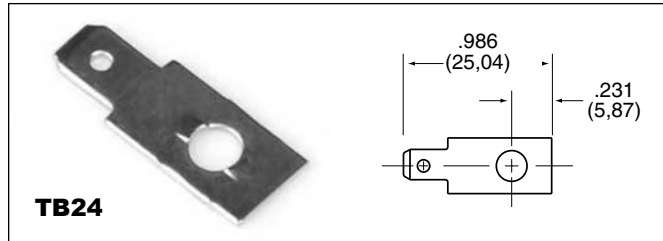
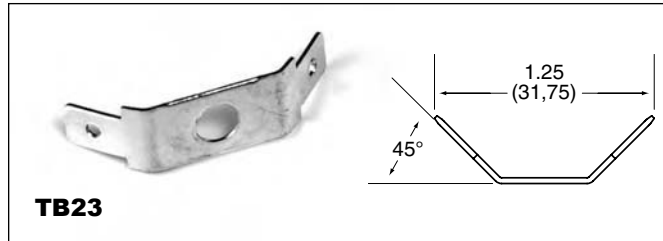
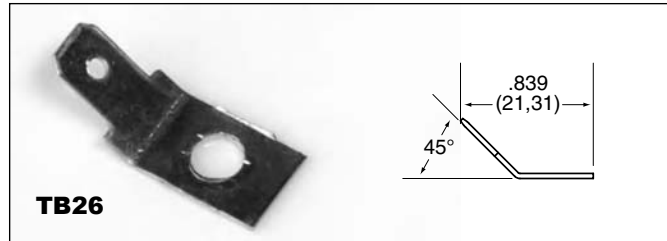
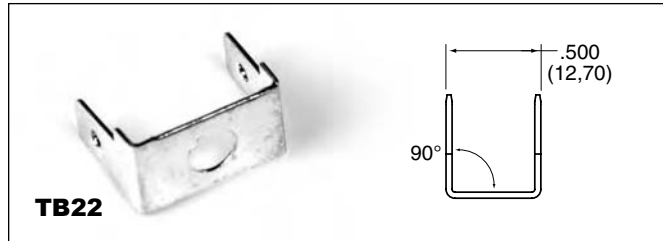

BARRIER STYLE



**TINNERMAN NUT**

GFT – for speed mounting of terminal blocks less mounting position.

Part No. TN-437.

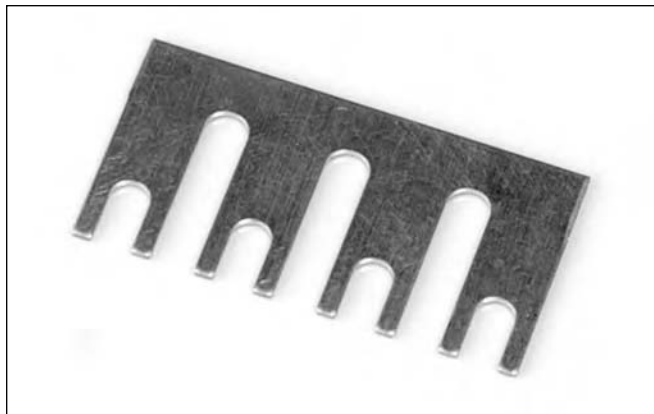
**TERMINAL BLOCK JUMPERS**

GB/GFT – Plated in two styles. Types 267A28 is designed to jump two adjacent terminals as it is channeled to cross over the barrier top. "Rooster comb" design of Type 267A42 permits connections of two to 18 poles.

To order, specify: Part No. 267A42 (plus no. of poles)

*Example: 267A42-18*

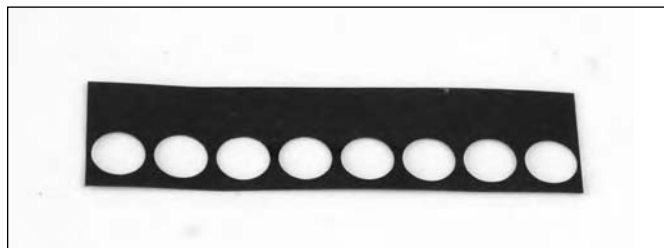
**MARKING STRIPS**

GB/GFT – Pre-punched black fiber . . . mounts under block. May be imprinted to customer specifications.

To order, specify: Part No. 267A19-1 thru 26 (with mounting hole); Part No. 267A18-1 thru 26 (less mounting hole).

**COVERS**

GB/GFT – Rigid .030" thick self-extinguishing vinyl. Black matte-finished on both sides. May double as marking strip when imprinted with white ink. Complete with spring clips for attaching to mounting positions.

Part No. 267B86-1 thru 26 terminals



# Series 1500 .375" (9.52mm) Center-to-Center Spacing

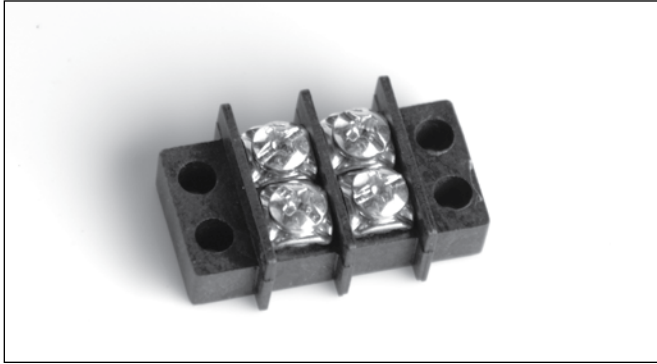

## Features:

- **Flexible Hi-Temp Thermoplastic Terminal Blocks** – Self-extinguishing types which resist breakage and other damage (conform to UL 94V-0).
- **Terminal Flexibility** – Ideal for surface mount, sub-panel or chassis connections in electronic/electrical circuit applications. One thru 22 terminals. 1500 Series is .375" on centers.
- **Economical Closed-Back Design** – No need for costly insulation strip.
- **Broad Wire Range** – No. 6-32 external twin screws, UL recognized for No. 22AWG to No. 10AWG. Variations include double solder lug, single solder lug, wire wrap, solder pin and printed circuit pin.
- **UL/CSA Electrical Ratings** – UL 30A/1100V RMS (1/3 breakdown voltage), CSA rating 15A/300V.
- **Recognition and Listing** – Various terminal types are UL recognized and CSA certified.

## Series 1500 Variations

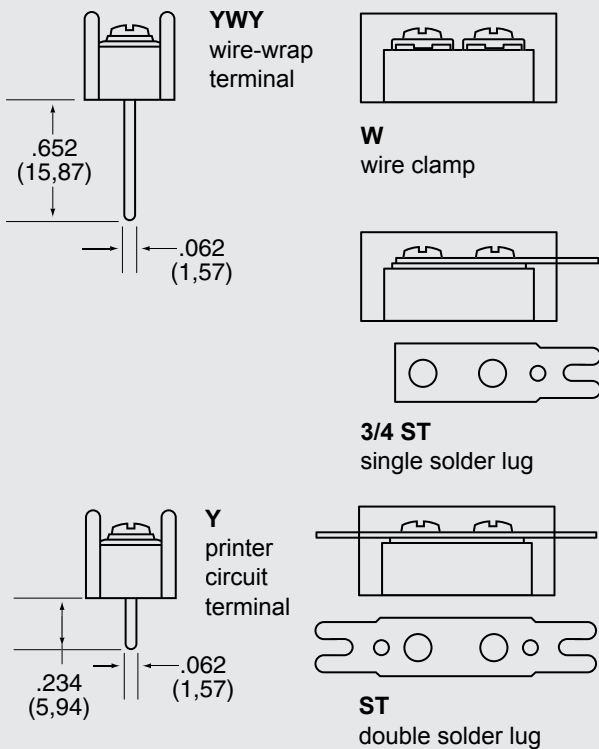

## INTERNAL TERMINAL DESIGNATIONS

- 1500-Y** printed circuit board design with .062" x .031" solderable tin-plated pin
- 1500-YWY** feed-thru wire wrap

## EXTERNAL TERMINAL DESIGNATIONS

- 1500** screw terminal with No. 6-32 plated steel\* screw accepting up to No. 10AWG wire
- 1500-ST** solderable tin-plated double solder tab
- 1500-3/4ST** solderable tin-plated single solder tab
- 1500-W** wire clamp captivated to a No. 6-32 plated steel screw

\* Other materials available – contact factory or your local representative for additional information.

 Recognized under the Components Program of Underwriters Laboratories, Inc. Standard 1059, Guide No. XCFR2, File No. E62557.

 Guide No. 22.2 No. 158, Report No. LR39186-1. **COMPLIES WITH IEC 947-7-1**

## Series 1500 Dimensions

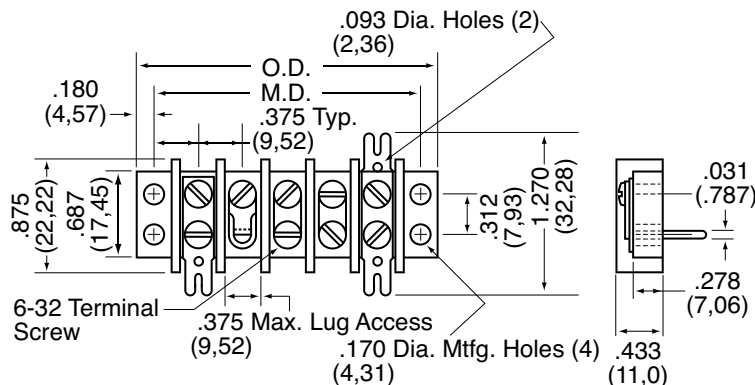

Dual Row

BARRIER STYLE



## Specifications:

**Center-to-Center Spacing:** .375" (9.52mm)

**Wire Range:** Up to No. 12AWG (CSA requires use of lugs on wire larger than No. 16AWG.)

**No. of Terminals:** 1 thru 22

### Voltage Rating:

CSA – 300V

UL – 150V – General Industrial

250V – Commercial Appliance

300V – Limited Energy Industrial

**Tightening Torque:** Wire Clamp and Wire Binding Screw 12 in.-lbs.

**Current Rating:** UL: 20 amps CSA: 15 amps

### Housing:

Material Polyphenylene Oxide

Continuous Use

Temp. (UL Index) 110°C (230°F)

Flammability Rating 94V-0

Water Absorption

(24 hrs. % wt. gain) .06%

Chemical Resistance Resistant to inorganic bases and acids. For organic substances contact factory for specific resistance.

### Breakdown Voltage:

Terminal - Terminal 3,400V Typ.

Terminal - Ground 7,300V Typ.

*Note:* Specifications contained herein are subject to change without notice.

## PC BOARD DRILLING DIMENSIONS

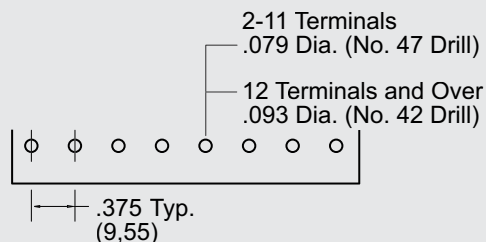

## How to Order

1500 Series terminal blocks are ordered by listing a composite number made up of the model designation in which the last two digits indicate the number of poles required for the application. Example: A 1500 10-terminal block (3/8" centers) becomes stock number 1510.

Suffixes are used as follows:

ST denotes double solder lug

3/4ST denotes single solder lug

Y denotes printed circuit pin

YWY feed-thru wire wrap

W wire clamp

The 1510 described above, with double solder lug mounting on 3/8" centers thus converts to stock number 1510-ST. To specify quick-connect terminals, simply add the style number required. (See accessories.) May be purchased factory-assembled or as customer-installed accessory.

Number of Terminals	Mounting Dimensions		Overall Dimensions	
	Inches	Metric (mm)	Inches	Metric (mm)
1	.750	19.05	1.030	26.16
2	1.125	28.57	1.405	35.68
3	1.500	38.10	1.780	45.21
4	1.875	47.62	2.155	54.73
5	2.250	57.15	2.530	64.26
6	2.625	66.67	2.905	73.78
7	3.000	76.20	3.280	83.31
8	3.375	85.72	3.655	92.83
9	3.750	95.25	4.030	102.36
10	4.125	104.77	4.405	111.88
11	4.500	114.30	4.780	121.41
12	4.875	123.82	5.155	130.93
13	5.250	133.35	5.530	140.46
14	5.625	142.87	5.905	149.98
15	6.000	152.40	6.280	159.51
16	6.375	161.92	6.655	169.03
17	6.750	171.45	7.030	178.56
18	7.125	180.97	7.405	188.08
19	7.500	190.05	7.780	197.61
20	7.875	200.02	8.155	207.13
21	8.250	209.55	8.530	216.66
22	8.625	219.07	8.905	226.18

Dimensions Shown are  $\pm 0.030$ "





# Series 2000 .4375" (11.1mm) Center-to-Center Spacing

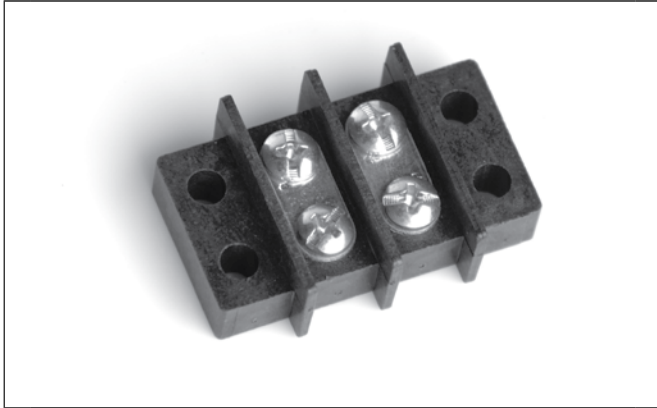

## Features:

- **Flexible Hi-Temp Thermoplastic Terminal Blocks** – Self-extinguishing types which resist breakage and other damage (conform to UL94V-0).
- **Terminal Flexibility** – Ideal for surface mount, sub-panel or chassis connections in electronic/electrical circuit applications. One thru 26 terminals.
- **Economical Closed-Back Design** – No need for costly insulation strip.
- **Broad Wire Range** – No. 6-32 external twin screws, UL recognized for No. 22AWG to No. 10AWG. Variations include double solder lug, single solder lug, wire wrap, solder pin and printed circuit pin.
- **UL/CSA Electrical Ratings** – UL 30A/1100V RMS (1/3 breakdown voltage), CSA rating: 20A/300.
- **Recognition and Listing** – Various terminal types are UL recognized and CSA certified.

## Series 2000 Variations

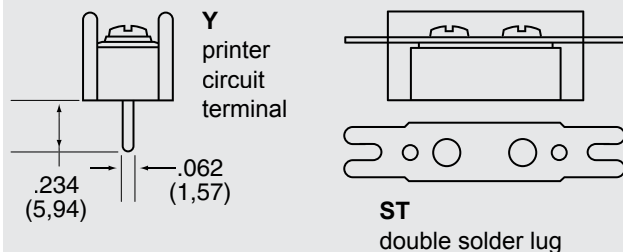
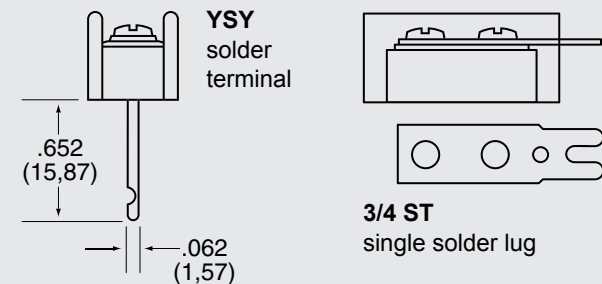
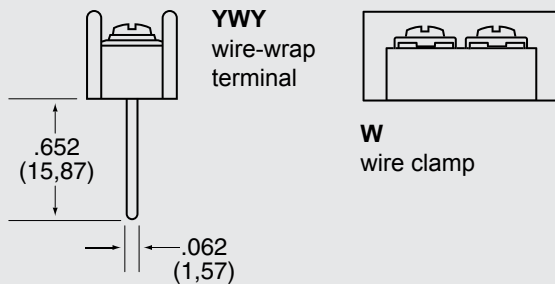

## INTERNAL TERMINAL DESIGNATIONS

- 2000-Y** printed circuit board design with .062" x .031" solderable tin-plated pin
- 2000-YSY** solder pin
- 2000-YWY** wire wrap

## EXTERNAL TERMINAL DESIGNATIONS

- 2000** screw terminal with No. 6-32 plated steel\* screw accepting up to No. 10AWG wire
- 2000-ST** solderable tin-plated double solder tab
- 2000-3/4ST** solderable tin-plated single solder tab
- 2000-W** wire clamp captivated to a No. 6-32 plated steel screw

\* Other materials available – contact factory or your local representative for additional information.

 Recognized under the Components Program of Underwriters Laboratories, Inc. Standard 1059, Guide No. XCFR2, File No. E62557.

 Guide No. 22.2 No. 158, Report No. LR39186-1. COMPLIES WITH IEC 947-7-1

## Series 2000 Dimensions

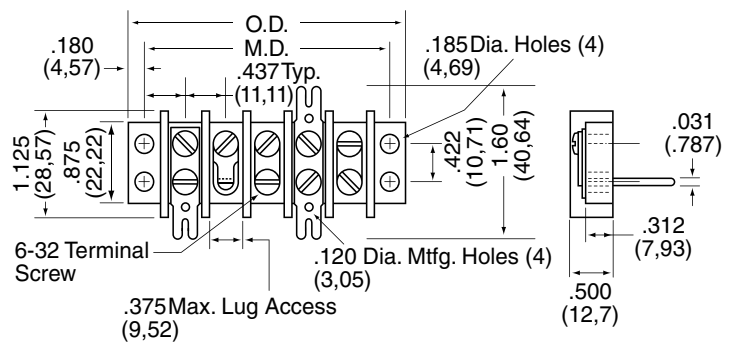

Dual Row

BARRIER STYLE



## Specifications:

**Center-to-Center Spacing:** .4375" (11.11mm)

**Wire Range:** Up to No. 10AWG (CSA requires use of lugs on wire larger than No. 16AWG.)

**No. of Terminals:** 1 thru 26

### Voltage Rating:

CSA – 300V

UL – 150V – General Industrial

250V – Commercial Appliance

300V – Limited Energy Industrial

**Tightening Torque:** Wire Clamp and Wire Binding Screw 12 in.-lbs.

**Current Rating:** UL: 30 amps CSA: 20 amps

### Housing:

Material Polyphenylene Oxide

Continuous Use

Temp. (UL Index) 110°C (230°F)

Flammability Rating 94V-0

Water Absorption

(24 hrs. % wt. gain) .06%

Chemical Resistance

Resistant to inorganic bases and acids. For organic substances contact factory for specific resistance.

### Breakdown Voltage:

Terminal - Terminal 4,400V Typ.

Terminal - Ground 7,700V Typ.

*Note:* Specifications contained herein are subject to change without notice

## PC BOARD DRILLING DIMENSIONS

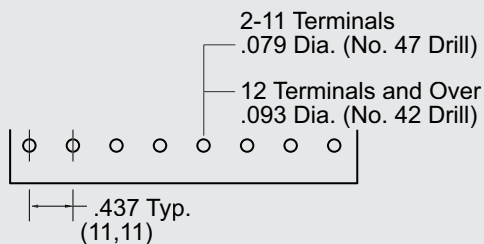

## How to Order

2000 Series terminal blocks are ordered by listing a composite number made up of the model designation in which the last two digits indicate the number of poles required for the application. Example: A 2000 10-terminal block becomes stock number 2010.

Suffixes are used as follows:

ST denotes double solder lug

3/4ST denotes single solder lug

Y denotes printed circuit pin

YSY solder pin

YWY wire wrap

W wire clamp

The 2010 described above, with double solder lug mounting on 7/16" centers thus converts to stock number 2010-ST. To specify quick-connect terminals, simply add the style number required. (See accessories.) May be purchased factory-assembled or as customer-installed accessory.

Number of Terminals	Mounting Dimensions		Overall Dimensions	
	Inches	Metric (mm)	Inches	Metric (mm)
1	.875	22.22	1.235	31.36
2	1.312	33.33	1.672	42.48
3	1.750	44.45	2.110	53.59
4	2.187	55.56	2.547	64.70
5	2.625	66.67	2.985	75.81
6	3.062	77.78	3.422	86.93
7	3.500	88.90	3.860	98.04
8	3.937	100.01	4.297	109.15
9	4.375	111.12	4.735	120.26
10	4.812	122.23	5.172	131.38
11	5.250	133.35	5.610	142.49
12	5.687	144.46	6.047	153.60
13	6.125	155.57	6.485	164.71
14	6.562	166.68	6.922	175.83
15	7.000	177.80	7.360	186.94
16	7.437	188.91	7.797	198.05
17	7.875	200.02	8.235	209.16
18	8.312	211.13	8.672	220.28
19	8.750	222.25	9.110	231.39
20	9.187	233.36	9.547	242.50
21	9.625	244.47	9.985	253.61
22	10.062	255.58	10.422	264.73
23	10.500	266.70	10.860	275.84
24	10.938	277.83	11.299	286.77
25	11.376	288.95	11.736	298.09
26	11.814	300.08	12.174	309.22

Dimensions Shown are  $\pm 0.030$ "



## Series 1500/2000 Accessories

### QUICK-CONNECT TERMINALS

1500/2000 – Available with .187" x .202" quick-connect tabs for 1500 series; .250" x .032" for 2000 series. Nine styles . . . tin-plated brass tabs held in place by terminal screws. Up to six terminations per pole. To order, specify:

1500 Series: Part No. TB11-19

2000 Series: Part No. TB31-39

Last digit of part number corresponds to previous style numbers.

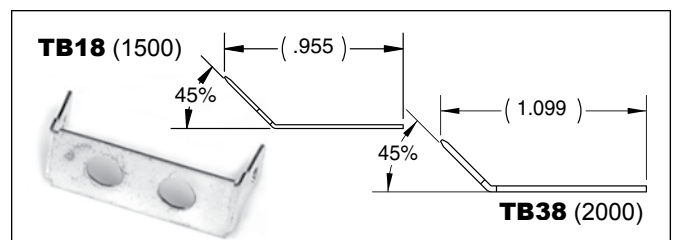
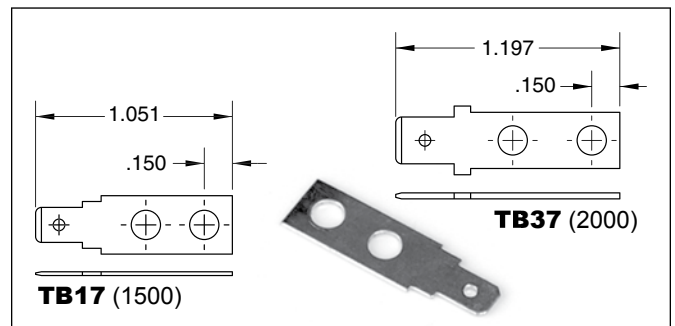
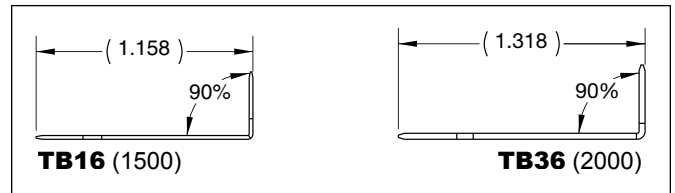
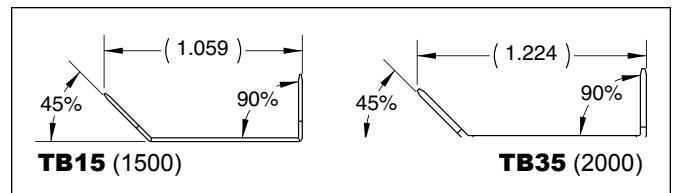
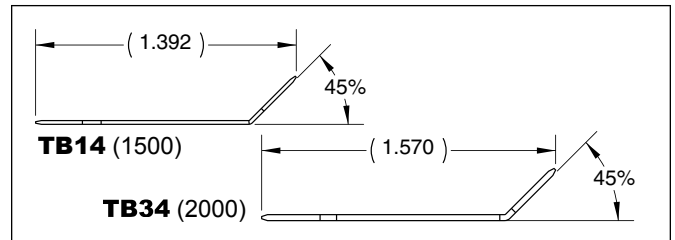
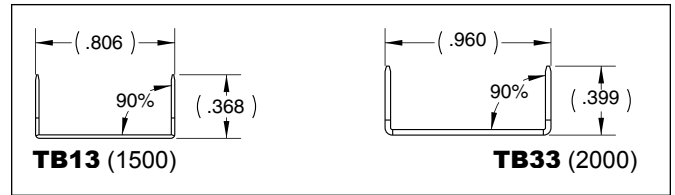
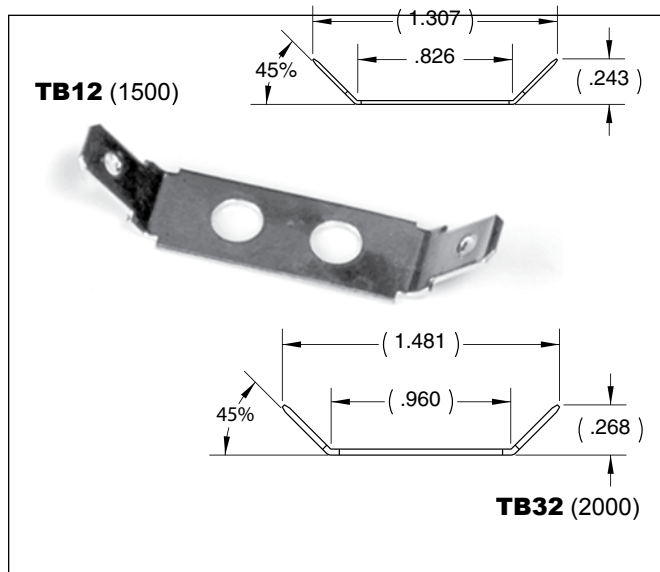
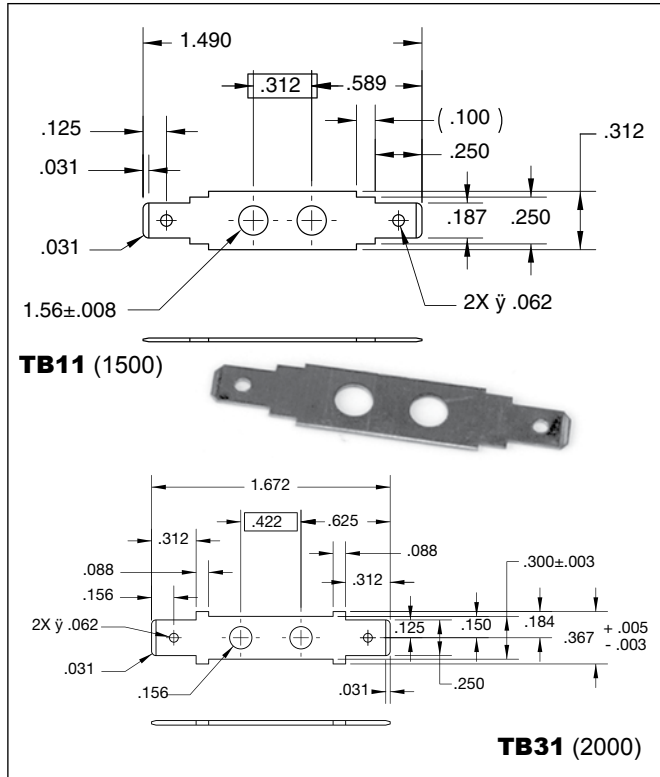

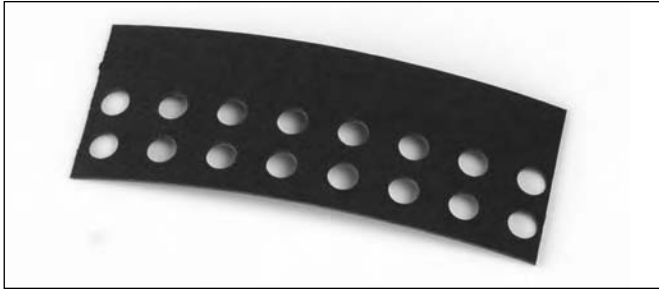

### MARKING STRIPS

1500/2000 Pre-punched black fiber . . . mounts under block.  
May be imprinted to customer specifications.

To order, specify:

1500 Series – Part No. 247A10-1 thru 22

2000 Series – Part No. 247A11-1 thru 22

### WIRE CLAMP

1500/2000 – Wire clamp captivated to No. 6-32 screw eliminates need for lugs.

1500 Series – Part No. 058525700

2000 Series – Part No. 058526700

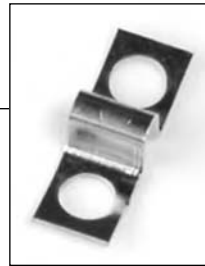
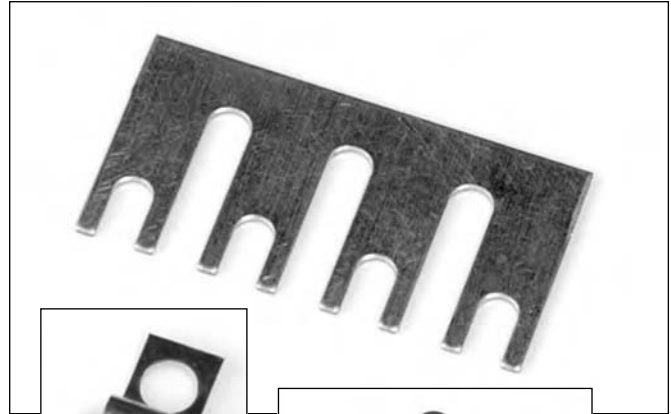

Part No.  
68240100



Part No. 68245100



### COVERS

1500/2000 – Rigid .030" thick self-extinguishing vinyl.  
Complete with spring clips for attaching to mounting positions.

To order, specify:

1500 Series – Part No. 247B24-1 thru 26 terminals

2000 Series – Part No. 247B25-1 thru 26 terminals

### TERMINAL BLOCK JUMPERS

1500 – Jumper is constructed of plated brass. "Rooster comb" design permits connections of two to 10 poles.

To order, specify: Part No. 278-A11 (plus no. of poles)

*Example: 278A11-10*

Part No. 68240100 (Holes) or 68245100 (slots)  
(2-pole jumper for 1500 only)

2000 – Plated brass in two styles. Types 278A28 is designed to jump two adjacent terminals as it is channeled to cross over the barrier top. "Rooster comb" design of Type 267A42 permits connections of two to 18 poles.

To order, specify: Part No. 267A42 (plus no. of poles)

*Example: 267A42-18*



# Series M .5" (12.7mm) Center-to-Center Spacing

Dual Row

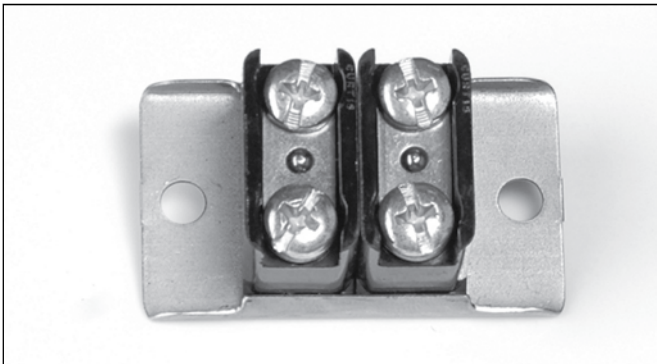



## Features:

- **Compact Modular Design for Low Power Circuits** – Suitable for surface connection applications using channel-assembled modular construction.
- **All-Surface Mountability** – Requires no additional insulation. Electro tin-coated steel mounting channel has two .196" diameter mounting holes.
- **Thermo-Set Phenolic Barrier-Type Terminal Blocks** – One thru 24 terminals on 1/2" center-to-center spacing.
- **Broad Choice of Terminal Connections** – Available in three screw designs and two .250" wide quick-connect variations offering up to four connections per terminal.
- **Wire Sizes** – M Series (No. 6-32 screw) is UL recognized for No. 22AWG to No. 14AWG. MA Series (No. 8-32 screw) is UL recognized for No. 22AWG to No. 12AWG. CSA requires lugs on wire larger than No. 14AWG for Series MA, and CSA requires lugs on No. 16AWG for Series M.
- **Current/Voltage Rating** – MA Series 15A/300V, M Series 15A/300V
- **Recognition and Listing** – Various terminal types are UL recognized and CSA certified.

## TERMINAL DESIGNATIONS

- \***MA** 16-gauge (.051") brass terminal bar with two No. 8-32 plated steel screws per terminal accepting wire up to No. 12AWG
- \***MAQ** Four .250" x .032" brass quick-connect tabs per terminal accepting wire up to No. 12AWG
- \***MALQ** Two .250" x .032" brass quick-connect tabs and one No. 8-32 plated steel screw per terminal accepting wire up to No. 12AWG. Rated 25A/300V
- \***M** Brass terminal bar with two No. 6-32 plated steel screws per terminal accepting wire up to No. 14AWG
- \***MC** Brass terminal bar with two-piece No. 6-32 plated steel, captivated clamp assemblies per terminal accepting wire up to No. 14AWG

 Recognized under the Components Program of Underwriters Laboratories, Inc. Standard 1059, Guide No. XCFR2, File No. E62557.

 Guide No. 22.2 No. 158, Report No. LR39186-1.

## Series M Variations

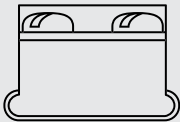

**MA**  
terminal bar with two  
No. 8-32 screws

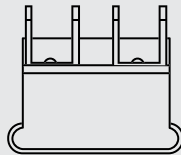

**MAQ**  
four .250" side  
quick-connects

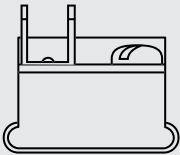

**MALQ**  
two .250" wide quick-  
connects and one  
No. 8-32 screw

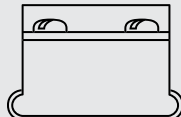

**M**  
terminal bar with two No.  
6-32 screws

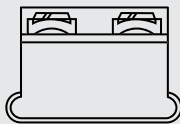

**MC**  
terminal bar with two  
captivated clamp assemblies

BARRIER STYLE





**Specifications:****Center-to-Center Spacing:** .5" (12.7mm)**Wire Range:**

UL Recognized

MA - No. 22AWG to 12 AWG

M - No. 22 AWG to 14 AWG

CSA:

Must use lugs for wire larger than

MA - 12 AWG

M - 16 AWG

**No. of Terminals:** 1 thru 24**Voltage Rating:**

CSA – 300V

UL – 150V – General Industrial

250V – Commercial Appliance

**Tightening Torque:** 12 in.-lbs.**Current Rating:** UL and CSA: 15A (M), 25A (MA)**Housing:**

Material Phenolic

Continuous Use

Temp. (UL Index) 150°C (302°F)

Flammability Rating 94V-0

Water Absorption

(24 hrs. % wt. gain) .05%

Chemical Resistance Resistant to most organic solvents

**Breakdown Voltage:**

Terminal - Terminal 7,400V Typ.

Terminal - Ground 7,800V Typ.

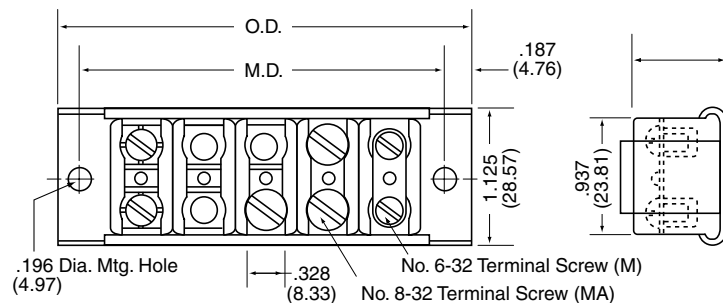
*Note:* Specifications contained herein are subject to change without notice.**Series M Dimensions****How to Order**

M Series terminal blocks are ordered by listing a composite number made up of the model designation followed by the number of poles required for the application. Example: Type M 10-pole block becomes stock number M-10.

Number of Terminals	Mounting Dimensions		Overall Dimensions	
	Inches	Metric (mm)	Inches	Metric (mm)
1	1.000	25.40	1.375	34.92
2	1.500	38.10	1.875	47.62
3	2.000	50.80	2.375	60.32
4	2.500	63.50	2.875	73.00
5	3.000	76.20	3.375	85.72
6	3.500	88.90	3.875	98.42
7	4.000	101.60	4.375	111.12
8	4.500	114.30	4.875	123.82
9	5.000	127.00	5.387	136.52
10	5.500	139.70	5.875	149.22
11	6.000	152.40	6.375	161.92
12	6.500	165.10	6.875	174.62
13	7.000	177.80	7.375	187.32
14	7.500	190.50	7.875	200.02
15	8.000	203.20	8.375	212.72
16	8.500	225.90	8.875	225.42
17	9.000	228.60	9.375	238.12
18	9.500	241.30	9.875	250.82
19	10.000	254.00	10.375	263.52
20	10.500	266.70	10.875	276.22
21	11.000	279.40	11.375	288.92
22	11.500	292.10	11.875	301.62
23	12.000	304.80	12.375	314.32
24	12.500	317.50	12.875	327.02

Dimensions shown are  $\pm 0.030$ "**Series M Accessories****COVER**

Plain cover of 1/16" thick black bakelite with two mounting studs. Supplied loose for customer installation.

**JUMPER**

Brass jumper rates at 25 amps.

Part No. 258-A5



# Series 5600 .563" (14.29mm) Center-to-Center Spacing

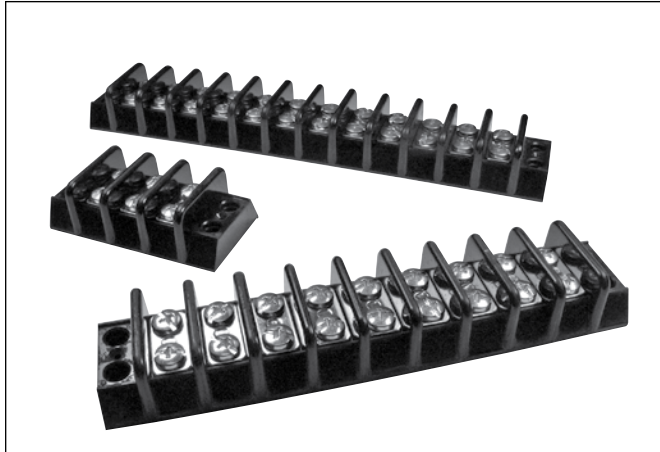

## Features:

- Durable, Hi-Temp, phenolic is self-extinguishing, resists breakage and conforms to UL94V-0
- Terminal Flexibility is ideal for surface mount, sub-panel or chassis connections. One thru 22 terminals. 9/16" center-to-center spacing.
- Economical Closed-Back Design does not require costly insulation strip
- Broad Wire Range using 8-32 or 10-32 external twin screws, UL recognized for No. 22 AWG to No. 10 AWG. Variations include double solder lug, single solder lug, wire wrap and printed circuit pin
- UL Electrical Ratings  
50Amp up to 600VAC dependent on options
- Field Wiring to 40A
- Factory Wiring to 50A
- Recognition  
Various terminal types are UL recognized and CSA certified.

 **UL Standard 1059,**  
Guide No. XCFR2

 **CSA Guide**  
22.2 No. 158

 **Designed to meet IEC 947-7-1**

Dual Row

## Series 5600 Variations

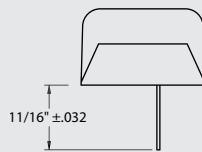
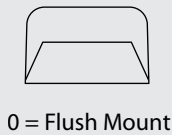

1 = Turret Type Solder Terminal

## Series 5600 Dimensions

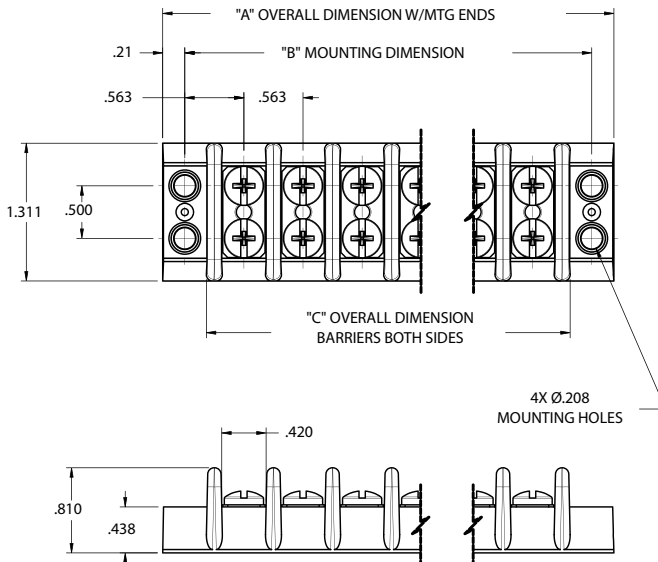

BARRIER STYLE

## Specifications:

**Center-to-Center Spacing:** .563" (14.29mm)

**Wire Range:** No. 22AWG to No. 8AWG (No. 8 with ring lug for #10 screw only)

**No. of Terminals:** 1 thru 22

**Voltage Rating:** 600V

**Tightening Torque:** 16 in.-lbs. with #8 screws  
20 in.-lbs. with #10 screws

### Current Rating:

50A with #8 or #10 screw and ring lug  
 40A with #10 screw  
 35A with #8 Screw  
 (Options may affect current rating)

### Housing:

Material	Phenolic
Continuous Use	
Temp. (UL Index)	150°C (302°F)
Flammability Rating	94V-0
Water Absorption	
(24 hrs. % wt. gain)	.1%

### Breakdown Voltage:

Terminal - Terminal	7,500 Vrms
Terminal - Ground	6,000 Vrms

## PC BOARD DRILLING DIMENSIONS

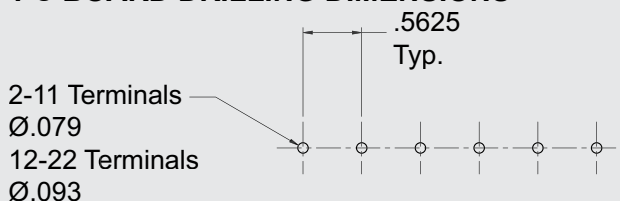

# How to Order

56 0 0 0 0 00 0

## MOLDING DESIGN

- 1 = Barriers Both Sides
- 2 = w/ Mounting Ends
- 3 = Y Pin with Barriers
- 4 = Y Pin with Mounting Ends
- 5 Thru 9 to be assigned.

## TERMINATION DESIGN

Part No. Digit	Terminal Plate Type	Screw Type	Approval	*Field/Factory
0 =	STEEL	STEEL	UR/cUR	2
1 =	STEEL	**BRASS	UR	1

\*\* SEMS NOT AVAILABLE IN BRASS  
\*1 = FACTORY WIRING ONLY  
2 = FACTORY & FIELD WIRING

## SCREW SIZE

- 0 = 8-32 Thread
- 1 = 10-32 Thread

## SPECIALS OR OPTIONAL DESIGNS

- 0 = None
- 1 = Double Tab, Flat (TB91)
- 2 = Double Tab, 45° Bend (TB92)
- 3 = Double Tab, 90° Bend (TB93)
- 7 = Single Tab, Flat (TB97)
- 8 = Single Tab, 45° Bend (TB98)
- 9 = Single Tab, 90° Bend (TB99)
- A thru Z to be assigned by engineering for special configurations (optional jumper available)

## NUMBER OF POLES AVAILABLE

- Available
- 01-22 w/ Mounting Ends
- 01-22 w/ Barriers Both Ends

## SCREW TYPE

- 0 = Binder Head, Combo Slot, Zinc Plated, Steel
- 2 = Binder Head, Combo Slot, Nickel Plated, Brass
- 4 = Wire Clamp Sems, Combo Slot, Zinc Plated, Steel
- 6 = Quick Connect Tabs Supplied w/ Binder Head (see special options)

Number of Terminals	Dimensions	
	"A" (Min-Max) Overall Dim. w/ Mounting Ends	"B" (Min-Max) Mounting Dim.
1	1.551-1.539	1.131-1.119
2	2.116-2.100	1.694-1.682
3	2.680-2.660	2.258-2.242
4	3.245-3.221	2.823-2.803
5	3.809-3.781	3.387-3.363
6	4.374-4.342	3.952-3.924
7	4.938-4.902	4.516-4.484
8	5.503-5.463	5.081-5.045
9	6.067-6.023	5.645-5.605
10	6.632-6.584	6.210-6.166
11	7.196-7.144	6.774-6.726
12	7.761-7.705	7.339-7.287
13	8.325-8.265	7.903-7.847
14	8.888-8.828	8.468-8.408
15	9.452-9.388	9.030-8.970
16	10.017-9.949	9.595-9.531
17	10.581-10.509	10.159-10.091
18	11.146-11.070	10.724-10.652
19	11.710-11.630	11.288-11.212
20	12.273-12.193	11.853-11.773
21	12.837-12.753	12.415-12.335
22	13.402-13.314	12.978-12.898

Dimensions shown are ± 0.030"



### Double Sided

- TB91
- TB92
- TB93

### Single Sided

- TB97
- TB98
- TB99

## Series 5600 Accessories

### QUICK CONNECT TERMINALS

.250" x .032" quick connect tabs available in 6 different styles. Tin-plated brass tabs are held in place by terminal screws. Terminal blocks can accommodate 1 to 6 terminations per pole. Factory assembled or shipped bulk.

### WIRE CLAMPS

Wire clamp captivated screws eliminate the need for lugs. Available for both 8-32 & 10-32 thread options, these screws accept up to No. 10AWG wire and may be factory installed or shipped bulk.

### TERMINAL BLOCK JUMPERS

Jumpers constructed of plated brass permit connections of 2 poles



Dual Row

BARRIER STYLE



# Series SW & DSW .375" (9.52mm) Center-to-Center Spacing

High Voltage/Current

BARRIER STYLE

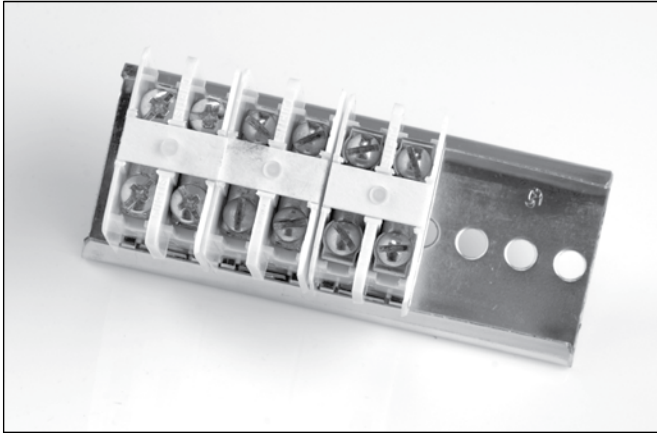

## Series SW & DSW Variations and Terminal Designations

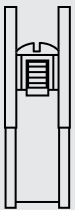

**SWS & DSWS** Brass terminal bars with No. 6-32 terminal screws. Accepts wire up to No. 14AWG. Requires the use of lugs.

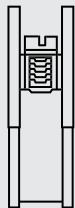

**SWT & DSWT** Solderless electro-tinned tubular connector with No. 10-32 terminal screws. Accepts wire from No. 16AWG to No. 8AWG.

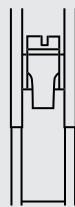

**SWTC & DSWTC** Solderless electro-tinned tubular connector with No. 10-32 terminal screws captivated by traveling pressure pad. Accepts wire from 22AWG to No. 8AWG.

*Note:* All variations as illustrated at left in two or three terminal modules only.

## Features:

- **Snap-In Track-Type Concept** – To assemble two or three-pole modules simultaneously, simply insert one edge of the module under the flange of the track and with very little pressure snap into place. To remove, push center section of spring toward molding. Module will “pop free.”
- **Total Modular Principle** – Two and three-pole nylon modules are complete with white fiber marking strips and retaining springs.
- **Reduced Inventory** – No end moldings, mounting brackets or metal mounting clamps are needed for assembly.
- **Compact Design** –  $3/8$ " center-to-center terminals provide compact circuit density. 32 poles per foot – 192 per six foot length.
- **Terminal Flexibility** – Three different terminal variations are available. Ratings up to 50A/600V.
- **Durable Modular Construction** – All SW models feature moldings of break-resistant nylon.
- **May be pre-assembled on track**
- **Wire Sizes** – Types SWS strap screw terminal with No. 6-32 screws. UL recognized for No. 22AWG to No. 14AWG. Type SWT tubular terminal with No. 10-32 screws. UL recognized for No. 16AWG to No. 8AWG. Type SWTC tubular clamp terminal with No. 10-32 screws. UL recognized for No. 22AWG to No. 8AWG.
- **Recognition and Listing** – UL recognized and CSA certified



Recognized under the Components Program of Underwriters Laboratories, Inc. Standard 1059, Guide No. XCFR2, File No. E62557.



Guide No. 22.2 No. 158, Report No. LR39186-1.

## Series SW Dimensions

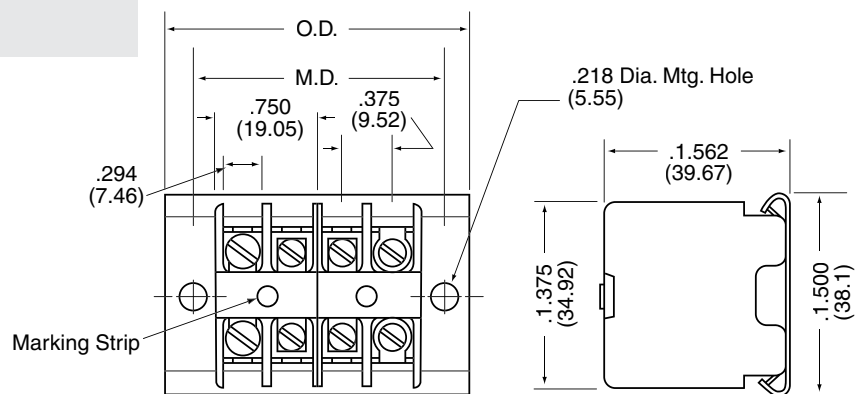

NOTE: mm dim. are shown in parentheses



## Specifications:

**Center-to-Center Spacing:** 3/8" (9.52mm)

**Wire Range:**

- SWS & DSWS – No. 22AWG to No. 14AWG – requires use of lugs
- SWT & DSWT – No. 16AWG to No. 8AWG
- SWTC & DSWTC – No. 22AWG to No. 8AWG

**No. of Terminals:** 2 thru 192

**Voltage Rating:** CSA & UL: 600V

**Tightening Torque:**

- SWS & DSWS 12 in.-lb.
- SWT & DSWT 25 in.-lb.
- SWTC & DSWTC 25 in.-lb.

**Current Rating:** SWS: 25A, SWT & SWTC: 50A

**Housing:**

- Material Polyamide
- Continuous Use
  - Temp. (UL Index) 125°C (257°F)
- Flammability Rating 94V-2
- Water Absorption (24 hrs. % wt. gain) 1.5%
- Chemical Resistance Outstanding resistance to both organic and inorganic substances

**Breakdown Voltage:** SWS/DSWS SWT/DSWT SWTC/DSWTC

- Terminal - Terminal 7,000V Typ. 4,700V Typ. 4,900V Typ.
- Terminal - Ground 8,400V Typ. 8,200V Typ. 9,300V Typ.

*Note:* Specifications contained herein are subject to change without notice.

## How to Order

SW and DSW Series modules are ordered by listing a composite number made up of the model designation preceded by the number of poles per module.

Prefixes are used as follows:

- 2P denotes 2-pole module
- 3P denotes 3-pole module

Example: a 2-pole SWT module becomes stock number 2PSWT; a 3-pole module becomes 3PSWT.

## Series DSW Dimensions

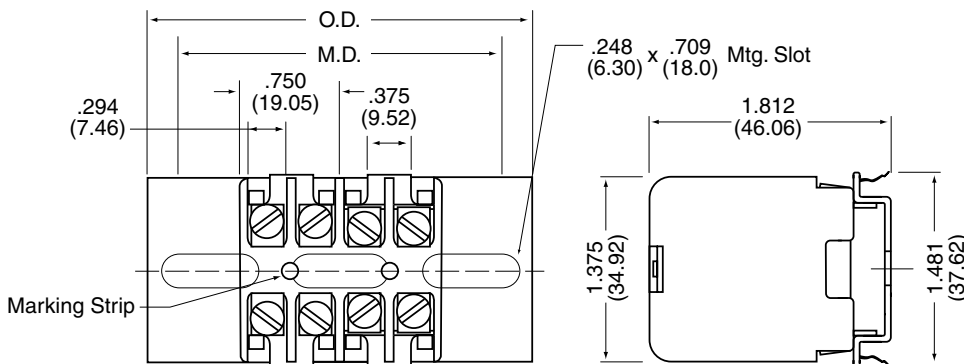

NOTE: mm dim. are shown in parentheses

Call factory for mounting dimensions on other lengths.

## Series SW and DSW Accessories

### MARKING STRIPS

White fiber marking strip available in two or three-pole lengths or in pre-punched 100-ft. rolls.

To order, specify:

Part No. 275A8 2PSW

Part No. 275A9 3PSW

100-ft. Rolls – Part No. 20SW Coil

Pins – Part No. 21SW Pin



### TERMINAL JUMPER CONNECTS

Brass jumper connects 12 consecutive terminals and can be cut for shorter applications

Part No. 275-A14.

Type 275-A16 is designed to connect two adjacent terminals.

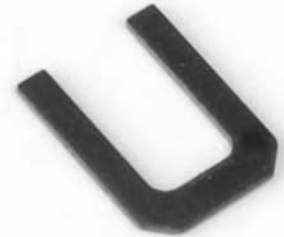



# Series W 7/16" (11.11mm) Center-to-Center Spacing

High Voltage/Current

BARRIER STYLE

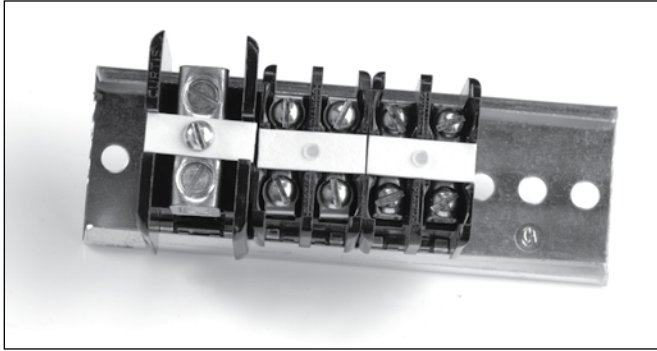

## Series W Variations and Terminal Designations

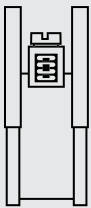

**WT** Solderless electro-tinned tubular connector with No. 10-32 terminal screws. Accepts wire from No. 16AWG to No. 8AWG. Rated 50A/600V.

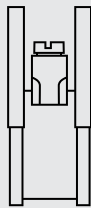

**WTC** Solderless electro-tinned tubular connector with No. 10-32 terminal screws capitivated by traveling pressure pad. Accepts wire from No. 22AWG to No. 8AWG. Rated 50A/600V

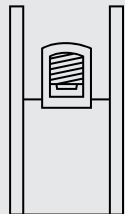

**WH** Solderless electro-tinned tubular connector with sidewall tapped for 5/16" - 24 terminal screw. Accepts wire from No. 22AWG to No. 4AWG. Rated 75A/600V.

## Series W Dimensions

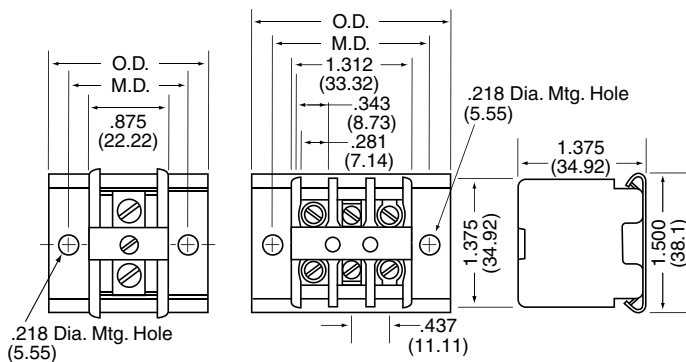

## Features:

- **Snap-In Track-Type Concept** – To assemble two or three-pole modules simultaneously, simply insert one edge of the module under the flange of the track and with very little pressure snap into place. To remove, push center section of spring toward molding. Module will “pop free.”
- **Total Modular Principle** – Two and three-pole phenolic modules are complete with white fiber marking strips and retaining springs.
- **Reduced Inventory** – No end moldings, mounting brackets or metal mounting clamps are needed for assembly.
- **Compact Design** –7/16" center-to-center terminals provide compact circuit density. 164 poles per six foot length.
- **Terminal Flexibility** – Three different terminal variations are available. Ratings up to 75A/600V.
- **Durable Modular Construction** – All W models feature rugged thermo-set phenolic moldings.
- **May be pre-assembled on track**
- **Wire Sizes** – Types WT with No. 10-32 tubular terminal screws UL recognized for No. 16AWG to No 8AWG. Type WTC tubular clamp terminal with No. 10-32 screws UL recognized for No. 22AWG to No. 8AWG. Type WH with 5/16-24 terminal screws UL recognized for No. 22AWG to No. 4AWG.
- **Recognition and Listing** – UL recognized and CSA certified

 Recognized under the Components Program of Underwriters Laboratories, Inc. Standard 1059, Guide No. XCFR2, File No. E62557.

 Guide No. 22.2 No. 158, Report No. LR39186-1.

## How to Order

W and DW Series modules are ordered by listing a composite number made up of the model designation preceded by a prefix which indicates the number of poles per module.

Prefixes are used as follows:

- P denotes 1-pole module
- 2P denotes 2-pole module

Example: a 2-pole WT module becomes stock number 2PWT and a WH Type available as single terminal module only is referred to as PWH. A 2-pole DWT module becomes stock number 2PDWT and a DWH Type available as a single terminal module only is referred to as PDWH.



## Specifications:

**Center-to-Center Spacing:** 7/16" (11.11mm)

### Wire Range:

WT – No. 16AWG to No. 8AWG  
 WTC – No. 22AWG to No. 8AWG  
 WH – No. 22AWG to No. 8AWG

**No. of Terminals:** 2 thru 164

**Voltage Rating:** CSA & UL: 600V

### Tightening Torque:

WT, WTC 25 in.-lb.  
 WH 45 in.-lb. (4-6AWG)  
 40 in.-lb. (8AWG)  
 35 in.-lb. (10-14 AWG)

**Current Rating:** WT, WTC: 50A, WH: 75A

### Housing:

Material	Phenolic
Continuous Use	
Temp. (UL Index)	150°C (302°F)
Flammability Rating	94V-1
Water Absorption	
(24 hrs. % wt. gain)	0.5%
Chemical Resistance	Resistant to most organic solvents

Breakdown Voltage:	WT	WTC	WH
Terminal - Terminal	6,300V Typ.	5,100V Typ.	10,500V Typ.
Terminal - Ground	10,100V Typ.	10,100V Typ.	7,700V Typ.

Note: Specifications contained herein are subject to change without notice.

## Series W Accessories

### MARKING STRIPS

White fiber marking strip available in two or three-pole lengths or in pre-punched 100-ft. rolls.

To order, specify:

Part No. 271A11 (2PW)

Part No. 271A13 (3PW)

100-ft. Rolls – Part No. 20W

Pins – Part No. 21W



### TERMINAL JUMPER CONNECTS

Brass jumper connects 12 consecutive terminals and can be cut for shorter applications. Part No. 271-A72

Type 275-A16 is designed to connect two adjacent terminals of WT and WTC assemblies.

Part No. 275-A16

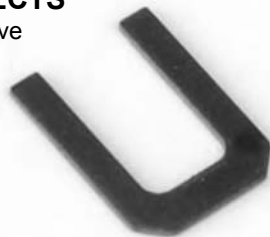

## Tracks

### Features:

- **STURDY TRACK** – constructed of heavy steel with zinc-dichromate plating. Mounting holes are 7/32 inch diameter and provided continuously on 3/8 inch center-to-center spacing (SW Series) and 7/16 inch centers (W Series). DIN mounting holes are slots .248" wide by .709" long on .984" center-to-center spacing.
- **ECONOMICAL STANDARD LENGTHS** – mounting track available in three and six-foot pre-cut lengths for self-cutting to application needs. DIN track available in two meter (78.74") lengths.
- **PRE-CUT TRACK** – available for large volume work where identical lengths are used. Save cutting time in your plant.
- **SW, DSW, W AND DW SERIES COMPATIBILITY** – track accommodates both W and SW Series of snap-in track type modules with any combination of terminal assemblies, fuse blocks, circuit breakers, etc. DIN track accommodates DW and DSW Series modules.

### How to Order

When ordering non-DIN track to a specified size, simply designate model followed by length required, expressed in poles. Example: SW with space for 24 poles plus two mounting holes becomes stock number SW-24. For standard three and six foot lengths, simply designate model followed by 96 or 192 respectively (SW Series) or 82/164 (W Series). Examples: SW-96 or SW-192; W-82 or W-164. For DIN track, specify DT and length of track desired (in 2.5 centimeter increments). For example, DT-10 designates DIN track 10 centimeters in length. Dimensions are ± .10 cm.

Fuse blocks, knife switches and WH Type terminal assemblies are the same width as two-pole W modules and therefore require twice the space of a single pole W.



# Type CDM 35/64" (13.86mm) Center-to-Center Spacing

High Voltage/Current

BARRIER STYLE

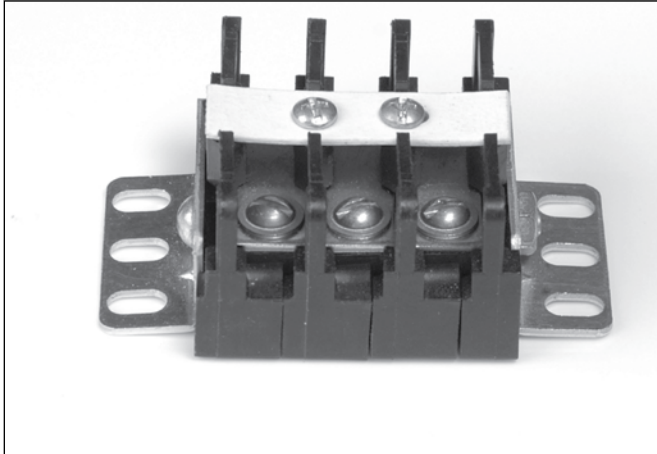

## Features:

- **Versatile Medium Power Terminal Blocks** – Designed for surface mount; power and control applications requiring a wide range of terminal variations.
- **Sectional Thru-Bolt Construction** – Available in one thru 50 terminals on 35/64" center-to-center spacing. Rated 30A/600V for Type CDM.
- **Durable Break-Resistant Thermoplastic Moldings**
- **Wire Sizes** – Type CDM features brass terminal bar with two No. 10-32 washer-head screws. UL recognized for No. 22AWG to No. 10AWG.
- **Easy Circuit Identification Design** – Barrer-type terminals are furnished with a white fiber marking strip.
- **Recognition and Listing** – Various terminal types are UL recognized and CSA certified

## Type CDM Terminal Designation

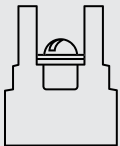

**CDM** brass terminal bar with two No. 10-32 washer-head screws accepting wire up to No. 10AWG. Rated 30A.

## Type CDM Dimensions

NOTE: mm dim. are shown in parentheses

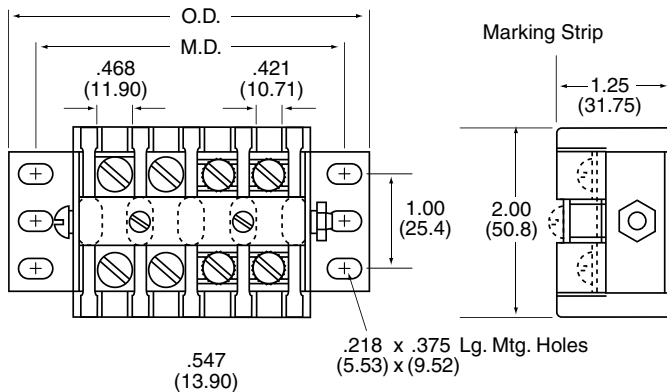

## Specifications:

**Center-to-Center Spacing:** 35/64" (13.86mm)

### Wire Range:

CDM: UL Recognized for 22AWG to No. 10AWG

**No. of Terminals:** 1 thru 50

**Voltage Rating:** CSA & UL: 600V

**Tightening Torque:** 35 in.-lb.

**Current Rating:** CDM: 30 amps, UL and CSA.

### Housing:

Material	Thermoplastic-polyester
Continuous Use Temp. (UL Index)	130°C (266°F)
Flammability Rating	94V-0
Water Absorption (24 hrs. % wt. gain)	0.7%
Chemical Resistance	Excellent in most environments

### Breakdown Voltage: CDM

Terminal - Terminal	9,600V Typ.
Terminal - Ground	10,800V Typ.

Note: Specifications contained herein are subject to change without notice.

Recognized under the Components Program of Underwriters Laboratories, Inc. Standard 1059, Guide No. XCFR2, File No. E62557.

Guide No. 184-N-90, Report No. LR39186-1.

Number of Terminals	Mounting Dimensions		Overall Dimensions	
	Inches	Metric (mm)	Inches	Metric (mm)
1	1.625	42.48	2.346	59.59
2	2.220	56.38	2.896	73.56
3	2.767	70.28	3.441	87.40
4	3.314	84.18	3.988	101.30
5	3.861	98.08	4.535	115.19
6	4.409	111.98	5.083	129.11
7	4.956	125.88	5.630	143.00
8	5.503	139.78	6.177	156.90
9	6.050	153.68	6.724	170.79
10	6.598	167.58	7.272	184.71

Dimensions shown are ± 0.030"



Number of Terminals	Mounting Dimensions		Overall Dimensions	
	Inches	Metric (mm)	Inches	Metric (mm)
11	7.145	181.48	7.819	198.60
12	7.692	195.38	8.366	212.50
13	8.239	209.28	8.913	226.39
14	8.787	223.18	9.461	240.31
15	9.334	237.08	10.008	254.20
16	9.881	250.98	10.555	268.10
17	10.428	264.88	11.102	281.99
18	10.976	278.78	11.650	295.91
19	11.523	292.68	12.197	309.80
20	12.070	306.58	12.744	323.70
21	12.617	320.48	13.291	337.59
22	13.165	334.38	13.839	351.51
23	13.712	348.28	14.386	365.40
24	14.259	362.18	14.933	379.30
25	14.806	376.08	15.480	393.19
26	15.354	389.98	16.028	407.11
27	15.901	403.88	16.575	421.01
28	16.448	417.78	17.122	434.90
29	16.995	431.68	17.669	448.79
30	17.543	445.58	18.217	462.71
31	18.090	459.48	18.764	476.61
32	18.637	473.38	19.311	490.50
33	19.184	487.28	19.858	504.39
34	19.732	501.18	20.406	518.31
35	20.279	515.08	20.953	532.21
36	20.826	528.98	21.500	546.10
37	21.373	542.88	22.047	559.99
38	21.921	556.78	22.595	573.91
39	22.468	570.68	23.142	587.81
40	23.015	584.58	23.689	601.70
41	23.562	598.48	24.236	615.59
42	24.110	612.38	24.784	629.51
43	24.657	626.28	25.331	643.41
44	25.204	640.18	25.878	657.30
45	25.751	654.08	26.425	671.20
46	26.299	667.98	26.973	685.11
47	26.846	681.88	27.520	699.01
48	27.393	695.78	28.067	712.90
49	27.940	709.68	28.614	726.80
50	28.488	723.50	29.162	740.71

Dimensions shown are  $\pm 0.030$ "

## How to Order

Type CDM terminal blocks are ordered by listing a composite number made up of the model designation followed by the number of poles required for the application. Example: 10-pole terminal block becomes stock number CDM-10.

### Series CDM Accessories

#### MARKING STRIPS

Two cover styles. Hinged cover of 3/16" thick black bakelite pivoting from special end brackets provide ready access to block. Factory-assembled and available only with original terminal block order. Plain cover of 1/16" thick black bakelite is permanently positioned to block with two screws. Factory-assembled or customer-installed.

To order, specify:

CDM (Plain) – Part No. 265A61 – 1 thru 50 terminals

CDM (Hinged) – Part No. 265A67 – 1 thru 50 terminals

#### JUMPERS

Cooper jumper rated 30A. Designed to fold over barrier to connect adjacent terminals. To order, specify:

Part No. 523-A91



# Series 71000 .629" (15.98mm) Center-to-Center Spacing

High Voltage/Current

BARRIER STYLE

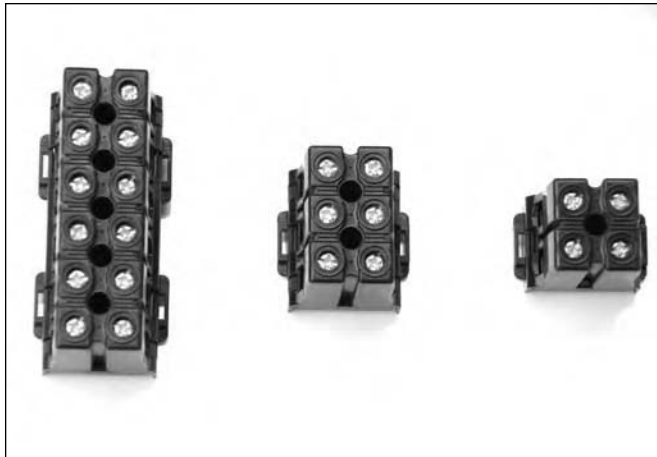

## Features:

- DIN rail or base mounting (panel mounting with #6 screw)
- Captive, combo head screws
- Factory or field wiring
- 600V at 85A
- Blocks can be placed end-to-end while maintaining center-to-center spacing
- .629 Center-to-Center Spacing
- Wire acceptance from 22AWG to 2AWG, 1AWG (7 & 19 strand only)
- No end moldings, mounting brackets or metal mounting clamps required
- Available pre-assembled to rail or in bulk



Recognized under the Components Program of Underwriters Laboratories, Inc. Standard 1059, Guide No. XCFR2, File No. E62557.



Guide No. 184-N-90, Report No. LR39186-1.

## Series 71000 6-Pole Dimensions

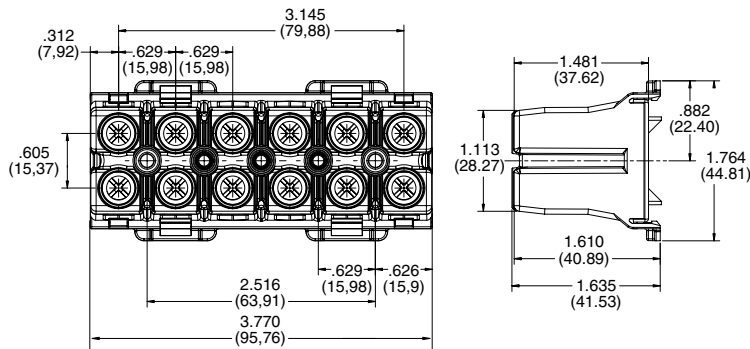

## Specifications:

**Center-to-Center Spacing:** .629" (15.98mm)

**Wire Range:**

1AWG (7 & 19 strand only), 2 AWG to 22AWG

**No. of Terminals:** 2, 3, 5 & 6

**Voltage Rating:** CSA & UL: 600V

**Tightening Torque:**

1AWG thru 4AWG	35 in.-lb. max
6AWG thru 14AWG	30 in.-lb. max
16AWG thru 22AWG	25 in.-lb. max

**Current Rating:**

86 amps – Copper Wire  
50 amps – Aluminum Wire

**Housing:**

Material	Reinforced PBT Polyester
Continuous Use	
Temp. (UL Index)	140°C (284°F)
Flammability Rating	94V-0
Water Absorption	
(24 hrs. % wt. gain)	0.7%
Chemical Resistance	Excellent in most environments

**Breakdown Voltage:**

Terminal - Terminal	7,500V Typ.
Terminal - Ground	7,000V Typ.

**Terminals:** 2, 3, 5 or 6





*How to Order*

71 0 2 X 000

**NUMBER OF POSITIONS**

1, 2, 3, 5 or 6, Number of Active Poles

**SPECIALS OR  
OPTIONAL DESIGNS**

0 = None

A-Z = Custom Configuration

High Voltage/Current

**BARRIER STYLE**



# Types H & BT .652" (16.56mm) Center-to-Center Spacing

High Voltage/Current

BARRIER STYLE

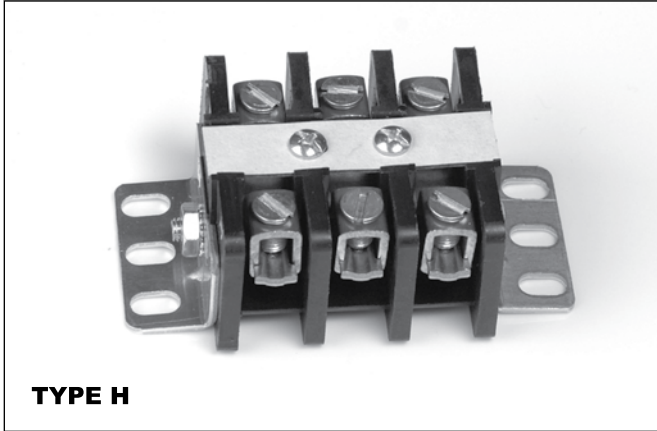

**TYPE H**

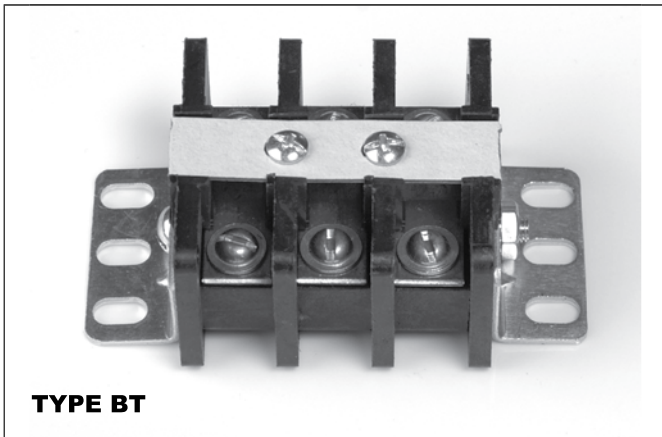

**TYPE BT**

### Types H & BT Terminal Variations

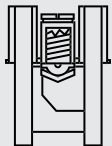

**H**  
high-pressure  
solderless connector

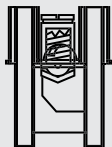

**BT**  
terminal bar with two  
No. 10-32 screws

### Features:

- **Sectional, High and Medium Power Terminal Blocks** – Designed for high power applications and control/power circuits respectively. Units approach power ratings of larger terminal blocks while retaining increased circuit density of low power designs.
- **Broad Terminal Choice** – One thru 30 terminals on .652" center-to-center spacing with white fiber circuit marking strips.
- **Thru-Bolt Barrier-Type Construction** – Rated at 75A/600V for Type H; 30A/600V for Type BT.
- **Unique Bar and Traveling Collar Design** – Eliminates lugging of wire on Type H. UL recognized for No. 16AWG to No. 4AWG. Type BT uses two No. 10-32 terminal screws, UL recognized for No. 22AWG to No. 10AWG.
- **Combined Style Flexibility** – Types can be used in combination as well as be combined with types L, O, S, T & U for greater application flexibility.
- **Recognition and Listing** – UL recognized and CSA certified

 Recognized under the Components Program of Underwriters Laboratories, Inc. Standard 1059, Guide No. XCFR2, File No. E62557.

 Guide No. 184-N-90, Report No. LR39186-1.

### TERMINAL DESIGNATIONS

- H** Brass bar with high-pressure solderless connectors accepting wire from No. 16AWG to 4AWG.
- BT** Brass terminal bar with two No. 10-32 plated steel terminal screws accepting wire up to No. 10AWG.

### Types H & BT Dimensions

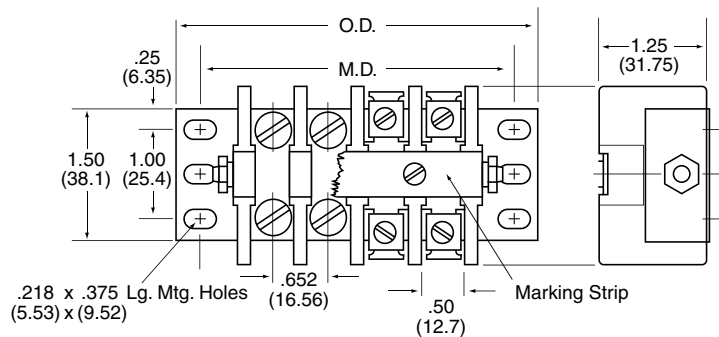

**Specifications:****Center-to-Center Spacing:** .652" (16.56mm)**Wire Range:**

H: UL Recognized for 16AWG to No. 4AWG

HT: UL Recognized for 22AWG to No. 10AWG

**No. of Terminals:** 1 thru 30**Voltage Rating:** CSA: 600V

UL: 600V General Industrial

**Tightening Torque:**

H: 45 in.-lb. (4WG to 6AWG)

40 in.-lb. (8AWG)

35 in.-lb. (10AWG to 16AWG)

BT: 20 in. - lbs.

**Current Rating:** H: 75 amps

BT: 30 amps, UL and CSA.

**Housing:**

Material Thermoplastic-Polyester

Continuous Use

Temp. (UL Index) 130°C (266°F)

Flammability Rating 94V-0

Water Absorption

(24 hrs. % wt. gain) 0.7%

Chemical Resistance Excellent in most environments

**Breakdown Voltage:****BT****H**

Terminal - Terminal 10,400V Typ. 8,100V Typ.

Terminal - Ground 8,400V Typ. 7,600V Typ.

*Note:* Specifications contained herein are subject to change without notice.**How to Order**

Types H and BT terminal blocks are ordered by listing a model number made up of the model designation followed by the number of terminals required for the application.

Example: a 10-pole terminal block becomes H-10 or BT-10

When ordering combinations of both types, the model number is made up of both model designations followed by total number of poles and number of each type. A composite of three H terminals followed by two BT terminals thus is converted to stock number HBT-5 (3H, 2BT).

Number of Terminals	Mounting Dimensions		Overall Dimensions	
	Inches	Metric (mm)	Inches	Metric (mm)
1	1.66	42.1	2.36	59.8
2	2.31	58.6	3.01	76.4
3	2.96	75.1	3.66	92.9
4	3.61	91.6	4.31	109.4
5	4.26	108.1	4.96	126.0
6	4.91	124.6	5.61	142.5
7	5.56	141.1	6.26	159.1
8	6.21	157.6	6.92	175.6
9	6.86	174.1	7.57	192.2
10	7.51	190.6	8.22	208.7
11	8.16	207.1	8.87	225.3
12	8.81	223.6	9.52	241.8
13	9.46	240.2	10.17	258.4
14	10.10	256.6	10.82	274.9
15	10.75	273.2	11.48	291.5
16	11.40	289.7	12.13	308.0
17	12.05	306.2	12.78	324.6
18	12.70	322.7	13.43	341.1
19	13.35	339.2	14.08	357.7
20	14.00	355.7	14.73	374.2
21	14.65	372.2	15.39	390.8
22	15.30	388.7	16.04	407.3
23	15.95	405.2	16.69	423.9
24	16.60	421.7	17.34	440.4
25	17.25	438.2	17.99	457.0
26	17.40	454.7	18.64	473.5
27	18.55	471.2	19.29	490.1
28	19.20	487.7	19.95	506.6
29	19.85	504.2	20.60	523.2
30	20.50	520.7	21.25	539.7

Dimensions shown are  $\pm 0.030$ "**Series H & BT Accessories****COVERS**

Series H &amp; BT – Two cover styles. Hinged cover of 3/16" thick black bakelite pivoting from special end brackets provide ready access to block. Factory-assembled and available only with original terminal block order. Plain cover of 1/16" thick black bakelite is permanently positioned to block with two screws. Factory-assembled or customer-installed.

To order, specify:

H/BT (Plain) – Part No. 260A49 – 1 thru 30 terminals

H (Hinged) – Part No. 260A56 – 1 thru 30 terminals

BT (Hinged) – Part No. 250A122 – 1 thru 30 terminals



# Types T & U 1.16" (28.46mm) Center-to-Center Spacing

High Voltage/Current

BARRIER STYLE

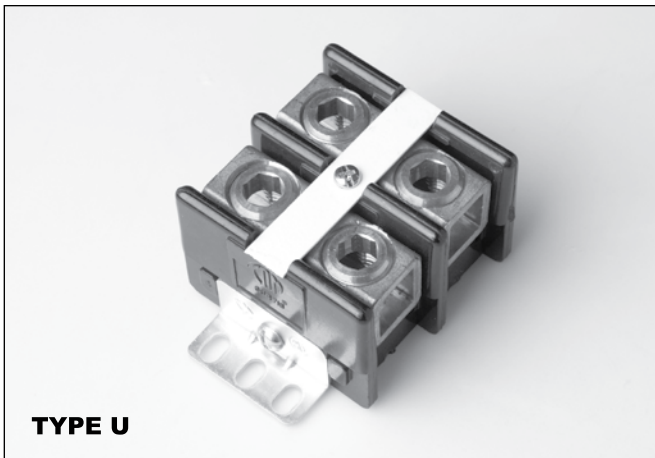
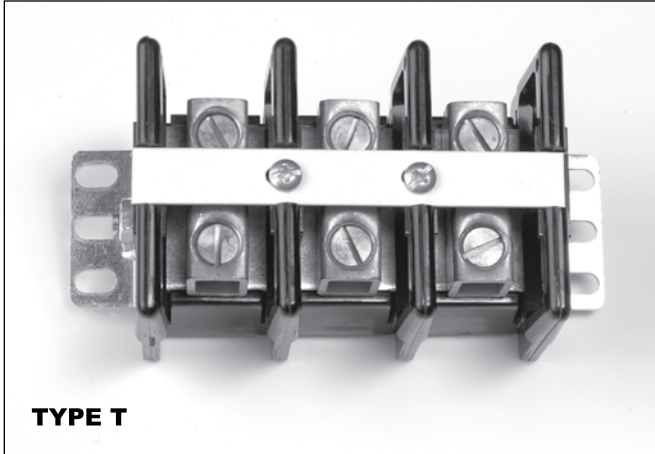

## Features:

- **Heavy Load Termination Flexibility** – Designed for machine, switchboard and other heavy load terminations.
- **Tubular, High Pressure Solderless Connections** – Accommodates wire without lugging – tapped sidewalls for greater mechanical strength – electrolytically pure copper solderless connections provide 100% conductivity.
- **Readily Adaptable to Special Applications** – Can be used for branch circuit termination with simple modification of standard terminal plate.
- **Combined Style Design Capability** – All types can be combined with each other as well as with Types H and BT.
- **Heavy Load Ratings and Wire Sizes** – Type T is rated at 125A/600V, has headless slotted screw, UL recognized for No. 6AWG to No. 1/0AWG wire. Type U is rated 250A/600V and features headless socket screw, UL recognized for No. 6AWG to 250MCM wire.
- **Recognition and Listing** – UL recognized and CSA certified

 Recognized under the Components Program of Underwriters Laboratories, Inc. Standard 1059, Guide No. XCFR2, File No. E62557.

 Guide No. 184-N-90, Report No. LR39186-1.

## Terminal Designations

- T** Tubular copper with tapped sidewalls and headless slotted screw. Accepts wire from No. 6 AWG to No. 1/0AWG.
- U** Tubular copper with tapped sidewalls and headless socket screw. Accepts wire from No. 6AWG to 250MCM.

## Types T & U Terminal Variations

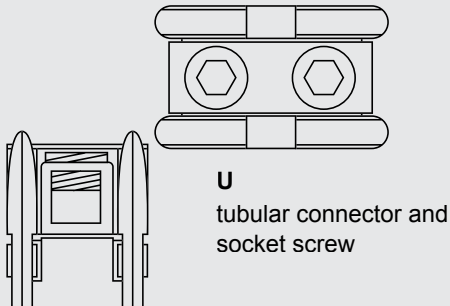
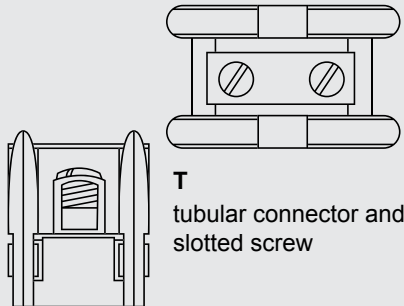

## Specifications:

### Wire Range:

- T – UL Recognized for No. 6AWG to No. 1/0AWG
- U – UL Recognized for No. 6AWG to 250MCM

**No. of Terminals:** T – 1 thru 6  
U – 1 thru 4

**Voltage Rating:** 600V CSA and UL

### Tightening Torque:

- T – 50 in.-lb.
- U – 275 in.-lb.

**Current Rating:** T: 125 amps, U: 250 amps

### Housing:

Material	Phenolic
Continuous Use	
Temp. (UL Index)	150°C (302°F)
Flammability Rating	94V-1
Water Absorption	
(24 hrs. % wt. gain)	0.5%
Chemical Resistance	Resistant to most organic solvents

<b>Breakdown Voltage:</b>	<b>T</b>	<b>U</b>
Terminal - Terminal	11,000V Typ.	9,000V Typ.
Terminal - Ground	9,700V Typ.	9,600V Typ.

*Note:* Specifications contained herein are subject to change without notice.

## How to Order

Types T and U terminal blocks are ordered by listing a composite number made up of the model designation followed by the number of terminals required for the application.

Example: a 4-pole terminal block becomes T-4 or U-4

When ordering combinations of both types, the composite number is made up of both model designations followed by total number of poles and number of each type. A composite of two T terminals followed by two U terminals thus is converted to stock number TU-4 (2T, 2U).

Combining these types with types L, O, S, H and BT would follow the same ordering format. (*Note:* When combined with types H or BT, a special adapter is required.)

Number of Terminals	Mounting Dimensions		Overall Dimensions	
	Inches	Metric (mm)	Inches	Metric (mm)
1	2.183	55.46	2.683	68.16
2	3.342	84.88	3.842	97.58
3	4.500	114.31	5.000	127.01
4	5.659	143.73	6.159	156.43
5	6.817	173.16	7.317	185.86
6	7.976	202.59	8.476	215.29

Dimensions shown are  $\pm 0.030$ "

## Types T & U Terminal Dimensions

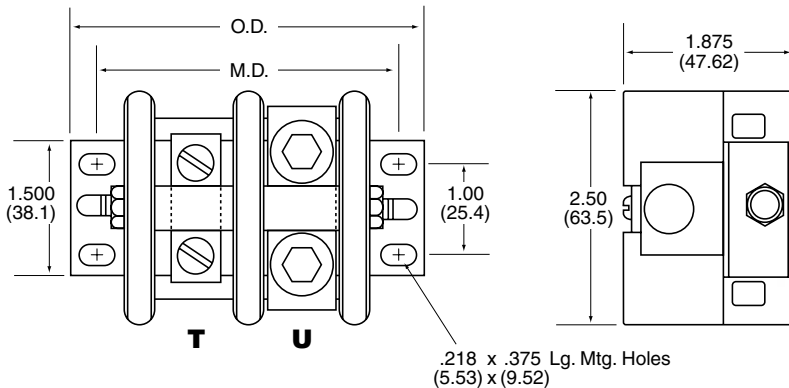

*NOTE:* Lugs are not finished with blocks mm dim. are shown in parentheses

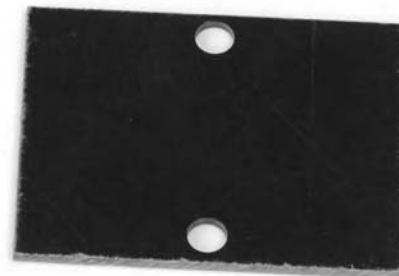

## Types T & U Accessories

### COVERS

Types T and U – Plain cover of 1/16" thick bakelite is permanently positioned to block with two screws. Factory-assembled or customer-installed.

To order, specify:

T – Part No. 268A157 – 1 thru 6 terminals

U – Part No. 268A157 – 1 thru 4 terminals





# Types L, O & S L – 1.16" (29.46mm), O – 1.86" (47.24mm),

High Voltage/Current

BARRIER STYLE

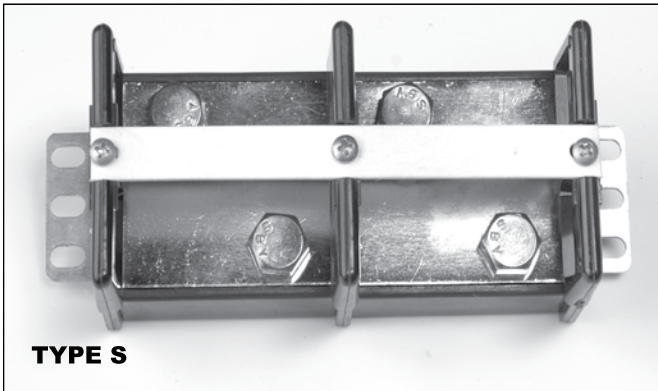
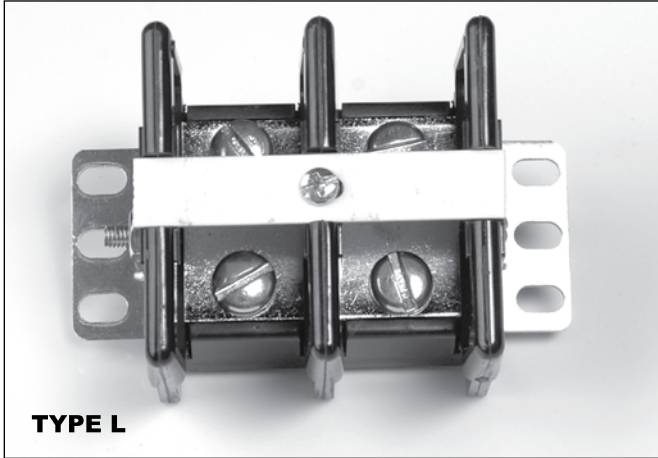

### Terminal Variations



**L**  
terminal bar and  
1/4" round-head  
screw, max.  
lug  
width – 27/32"

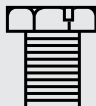

**O**  
terminal bar and  
5/16" slotted hex-  
headscrew, max.  
lug width – 3/4"

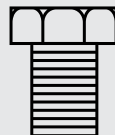

**S**  
terminal bar and  
3/8" slotted hex-  
headscrew, max.  
lug width – 1"

### Features:

- **Heavy Load Termination Flexibility** – Designed for machine, switchboard and other heavy load terminations.
- **Readily Adaptable to Special Applications** – Can be used for branch circuit termination with simple modification of standard terminal plate.
- **Combined Style Design Capability** – All types can be combined with each other as well as with Types H and BT.
- **Ratings and Wire Sizes to Match High Current Needs** – Type L is rated at 100A/600V, UL recognized for wire up to No. 1AWG. Type O is rated 125A/600, UL recognized for wire up to No. 1/0AWG. Type S is rated 225A/600V, UL recognized for wire up to No. 4/0AWG. (Note: UL requires the use of UL recognized lugs.)
- **Recognition and Listing** – UL recognized and CSA certified

### TERMINAL DESIGNATIONS

- L** Nickel-plated brass terminal bar with 1/4" – 20 plated round-head steel screws. Accepts wire up to No. 1AWG.
- O** Nickel-plated brass terminal bar with 5/16" – 18 plated slotted hex-head steel screws. Accepts wire up to No. 1/0AWG.
- S** Nickel-plated brass terminal bar with 3/8" plated hex-head steel screws. Accepts wire up to No. 4/0AWG.



Recognized under the Components Program of Underwriters Laboratories, Inc. Standard 1059, Guide No. XCFR2, File No. E62557.



Guide No. 184-N-90, Report No. LR39186-1.

### Types L, O & S Terminal Dimensions

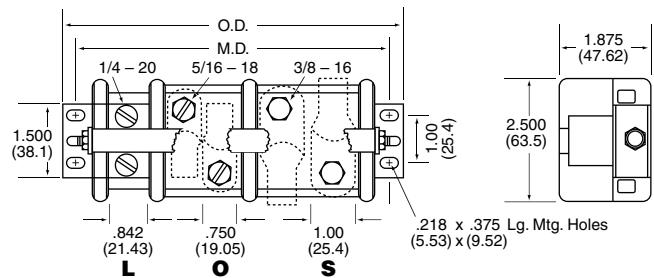

NOTE: Lugs are not finished with blocks mm dim. are shown in parentheses



## S – 2.42" (61.47mm) Center-to-Center Spacing

### Specifications:

#### Wire Range:

L – UL Recognized for No. 1AWG  
 O – UL Recognized for No. 1/0AWG  
 S – UL Recognized for No. 4/0AWG

**No. of Terminals:** L – 1 thru 12  
 O – 1 thru 4  
 S – 1 thru 4

**Voltage Rating:** 600V CSA and UL

**Tightening Torque:** L – 50 in.-lb.  
 O – 50 in.-lb.  
 S – 200 in.-lb.

**Current Rating:** L – 100A, O – 125A, S – 225A

#### Housing:

Material Phenolic  
 Continuous Use  
 Temp. (UL Index) 150°C (302°F)  
 Flammability Rating 94V-1  
 Water Absorption  
 (24 hrs. % wt. gain) 0.5%  
 Chemical Resistance Resistant to most organic solvents

**Breakdown Voltage:** L O S  
 Terminal - Terminal 11,000V Typ. 10,900V Typ. 10,400V Typ.  
 Terminal - Ground 9,700V Typ. 10,300V Typ. 10,500V Typ.

Note: Specifications contained herein are subject to change without notice.

### Series L, O & S Accessories

#### COVERS

Types T and U – Plain cover of 1/16" thick bakelite is permanently positioned to block with two screws. Factory-assembled or customer-installed.

To order, specify:

L – Part No. 268A158 – 1 thru 12 terminals  
 O – Part No. 268A159 – 1 thru 4 terminals  
 S – Part No. 268A160 – 1 thru 4 terminals

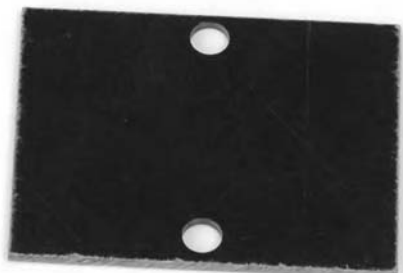

### How to Order

Types L, O and S terminal blocks are ordered by listing a model number made up of the series designation followed by the number of terminals required for the application.

Example: a 4-pole terminal block becomes L-4, O-4 or S-4

When ordering combinations of both types, the model number is made up of both series designations followed by total number of poles and number of each type. A model number of two L terminals followed by two O terminals thus is converted to stock number LO-4 (2L, 2O).

Combining these types with types T, U, S, H and BT would follow the same ordering format. (Note: When combined with types H or BT, a special adapter is required.)

#### Type L

Number of Terminals	Mounting Dimensions		Overall Dimensions	
	Inches	Metric (mm)	Inches	Metric (mm)
1	2.183	55.46	2.683	68.16
2	3.342	84.88	3.842	97.58
3	4.500	114.31	5.000	127.0
4	5.659	143.73	6.159	156.43
5	6.817	173.16	7.317	185.86
6	7.976	202.59	8.476	215.29
7	9.134	232.01	9.634	244.71
8	10.293	261.44	10.793	274.14
9	11.451	290.86	11.951	303.56
10	12.610	320.29	13.110	332.99
11	13.768	349.71	14.268	362.41
12	14.927	379.14	15.427	391.84

#### Type O

Number of Terminals	Mounting Dimensions		Overall Dimensions	
	Inches	Metric (mm)	Inches	Metric (mm)
1	2.880	73.16	3.380	85.86
2	4.736	120.29	5.236	132.99
3	6.591	167.42	7.091	180.12
4	8.447	214.55	8.947	227.25

#### Type S

Number of Terminals	Mounting Dimensions		Overall Dimensions	
	Inches	Metric (mm)	Inches	Metric (mm)
1	3.440	87.38	3.940	100.08
2	5.856	148.74	6.356	161.44
3	8.271	210.09	8.771	222.79
4	10.687	271.44	11.187	284.14

Dimensions shown are ± 0.030"



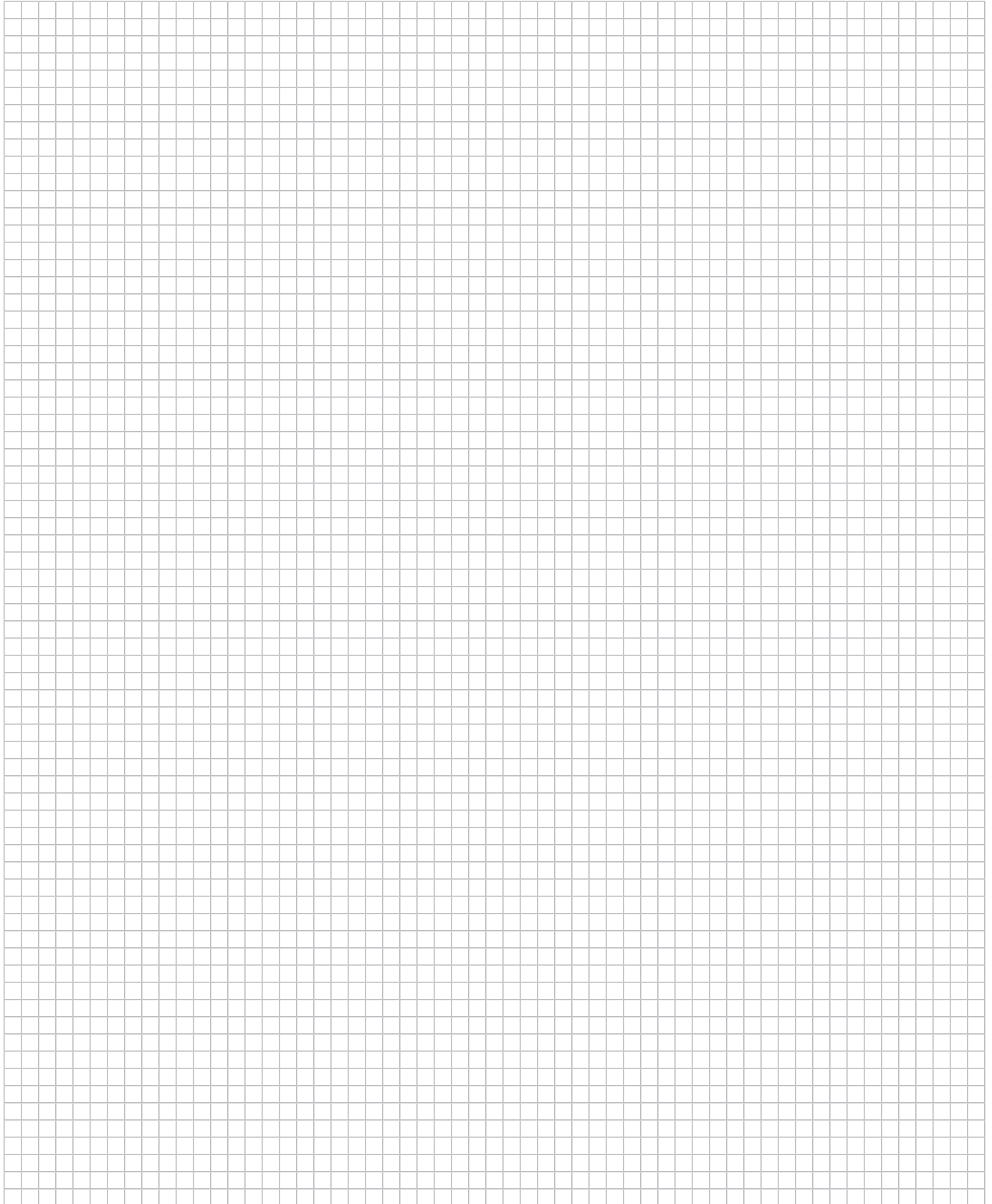

# RELAY SOCKETS ]

## *Snap-In Socket Assemblies*

### *CUS Series*

### *RS Series*

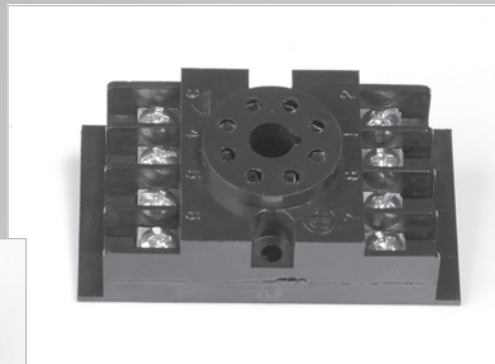
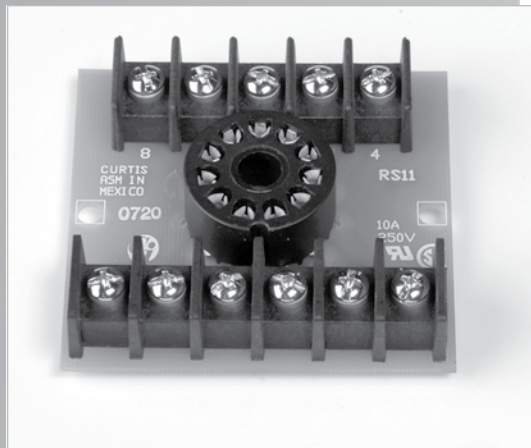

# \*Snap-In Socket Assemblies

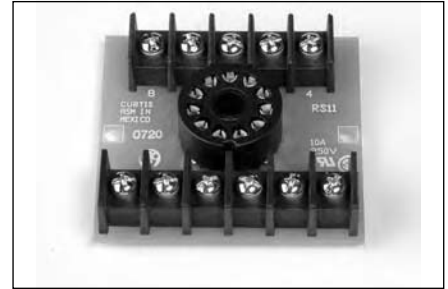
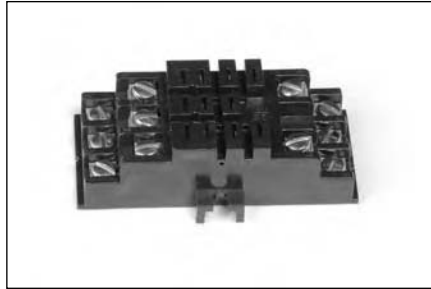
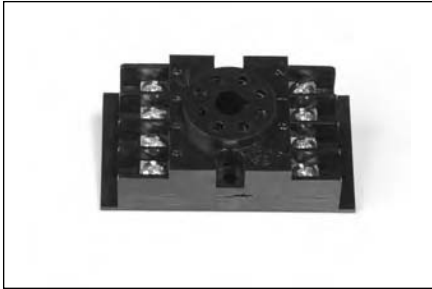

## Features:

- Permanent-numbered terminals for easy identification
- New unitized, thermoplastic sockets with closed-back design which eliminates panel insulation, and resists breakage
- Nickel-plated screw-type terminals on break-resistant barrier-type terminal block for fast, easy connection. Screw-type terminals on other models with captivated wire clamps to eliminate lugging.
- Compact, printed circuit design
- Glass epoxy G-10 printed circuit boards
- Relay sockets can be spaced out in track for convenient insertion of marking strips, for relay identification
- High-quality sockets for maximum relay retention and electrical conductivity

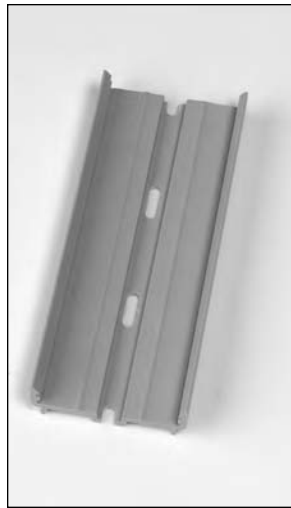

## Track



- Assemblies snap in and out without disturbing adjacent units (except for dovetail design on CUS5, 12, 14, 15, and 16)
- Lengths up to 48" – holds up to 30 socket assemblies
- Pre-punched track minimizes mounting time. (On lengths of 48", drilling and tapping is only required for two or three mounting screws instead of two holes per socket.)
- Wide center channel provides space for under-board components. Allows greater surface area for easy mounting with adhesive tape.
- Grey PVC thermoplastic, UL flame class 94V-0, suitable for ambient temperatures up to 50° C.
- Vertical rib track provides support to prevent PC board breakage—supplies spring retention and electrical base insulation.
- Optional snap-on end retaining clips available for long vertical mounts or extreme vibration if end socket assembly is not mounted with screws.
- Available in three popular widths for maximum circuit design flexibility.
  - TR1 for 2-3/16" board or socket
  - TR2 for 2-3/4" PC board or socket.
  - TR3 for 3-1/4" PC board or socket

## HOW TO ORDER

Relay socket assemblies can be ordered in parts form (assemblies and track separate) or factory assembled in specific length units. When ordering factory assembled units, specify type — number of sockets in continuous one-piece precut track; for example, order RS8-17 for a track containing 17 RS8 relay socket assemblies.

\* Many Curtis Socket Assemblies are recognized under the Components Program of Underwriters Laboratories, Inc. under file No. E59934. These units are made with a  on the following pages. Socket Assemblies listed by Canadian Standards Association are marked with a  and are covered by Report No. LR19623.





# CUS Series

## CUS8 and CUS11

### 8 and 11-Pin Unitized Octal-Type Socket Assemblies

#### Specifications:

**Rating:** 10 amps, 300 volts

**Track:** TR2

48" length holds up to 30 CUS8 sockets and 21 CUS11 sockets

**Terminals:** 6 thru 32 with captivated traveling nut

**Wire:** Up to No. 12AWG wire

**Sockets:** CUS8 – 8-pin receptacle for 2PDT octal relay or timer  
CUS11 – 11-pin receptacle for 3PDT octal relay or timer

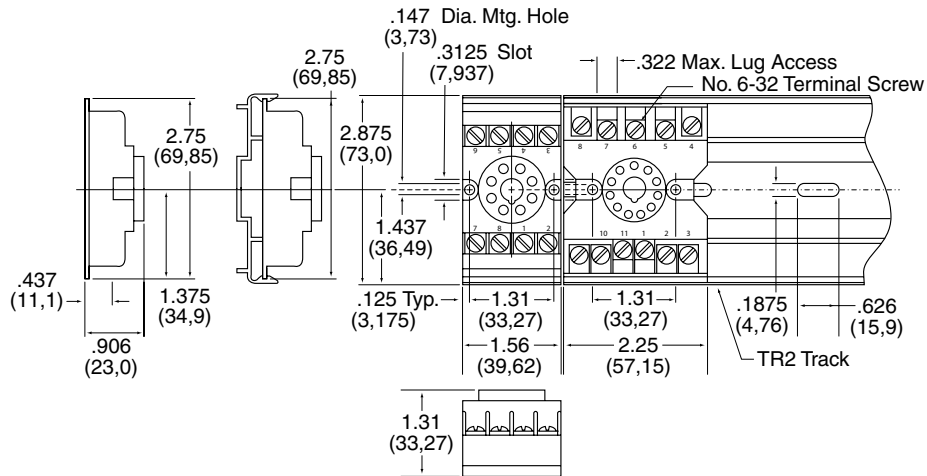

## CUS5, CUS12 and CUS16

### 5, 8 and 11-Pin Unitized Square-Base Relay-Type Socket Assemblies

#### Specifications:

**Rating:** 15 amps, 250 volts (CSA rated 15 amps, 125 volts)

**Track:** TR3

48" length holds up to 28 sockets

**Terminals:** 6 thru 32 with captivated traveling nut

**Wire:** Up to No. 14AWG wire

**Sockets:** CUS12 – 11-pin receptacle for 3PDT square-base barrier-type plug-in relays  
CUS16 – 8-pin receptacle for 2PDT square-base, barrier type plug-in relays  
CUS5 – 5-pin receptacle for SPDT square-base, barrier type plug-in relays

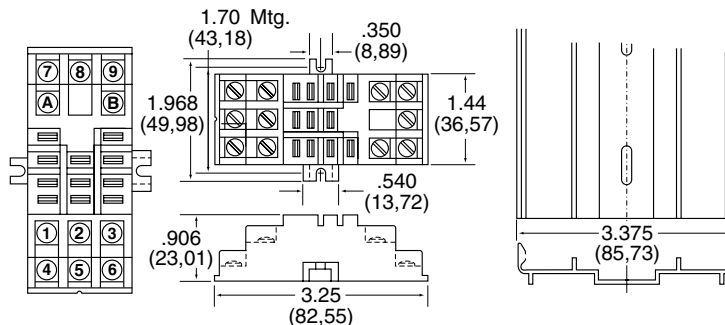
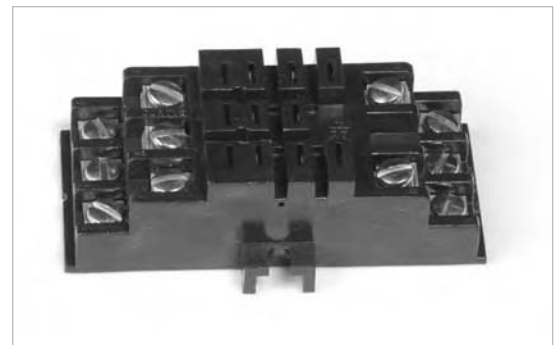

RELAY SOCKETS



# RS Series

## RS8

### 8-Pin Octal-Type Socket Assemblies

#### Specifications:

**Rating:** 10 amps, 250 volts

**Track:** TR2

48" length holds up to 24 sockets

**No. of Terminals:** RS8 – No. 6-32 screws, 7/16" center-to-center spacing



**Wire:** RS8 – up to No. 12 AWG (lugs are recommended on wire larger than No. 16AWG)

**Sockets:** 8-pin octal receptacle to accept standard 2PDT chamber allows relays to be rocked out without danger of damaging relay center posts. PC board has center post clearance hole to allow relays with screws in center post. Phosphor bronze contacts for better pin contact and retention.

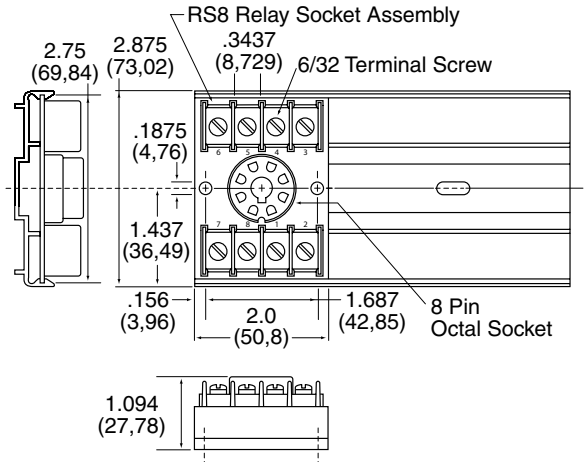

## RS11

### 11-Pin Octal-Type Socket Assemblies

#### Specifications:

**Rating:** 10 amps, 250 volts

**Track:** TR2

48" length holds up to 16 sockets

**No. of Terminals:** RS11 – No. 6-32 screws, 7/16" center-to-center spacing

**Wire:** RS11 – up to No. 12 AWG (lugs are recommended on wire larger than No. 16AWG)

**Sockets:** 11-pin octal receptacle to accept 3PDT chamber allows relays. Refer to RS8 socket for features.

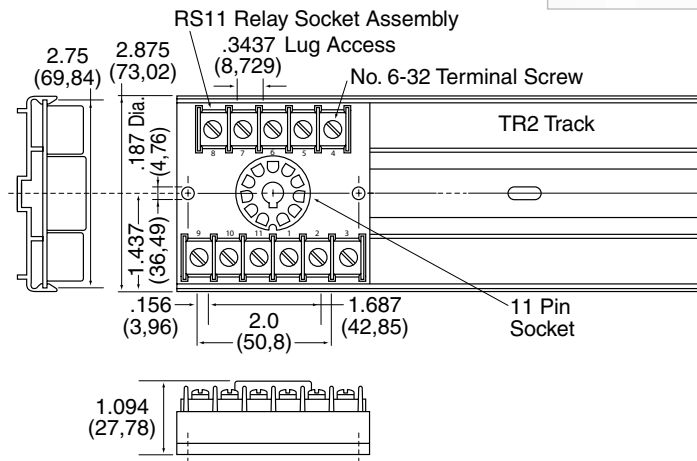

# RS2, RS4 and RS6

10, 16, and 22-Pin Square-Base  
Miniature Relay-Type Socket Assemblies

## Specifications:

**Rating:** 5 amps, 125 volts (UL rated 3 amps, 125 volts)

**Track:** TR1

48" length holds up to 24 RS2 sockets, 21 RS4 sockets and 16 RS6 sockets

**No. of Terminals:** No. 2-56 screws with clamp – 1/4" center-to-center spacing

**Wire:** Up to No. 16AWG

**Sockets:** RS2 – 10-pin receptacle to accept miniature 2PDT relays with latching coils

RS4 – 16-pin receptacle to accept miniature 4PDT relays with latching coils

RS6 – 22-pin receptacle to accept miniature 6PDT relays with latching coils

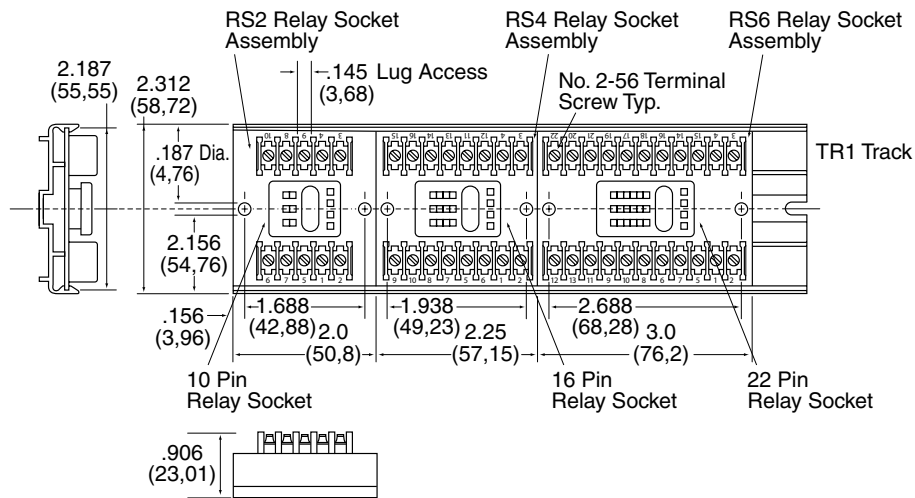
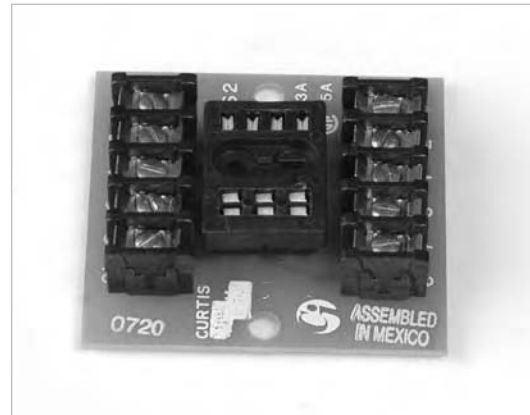
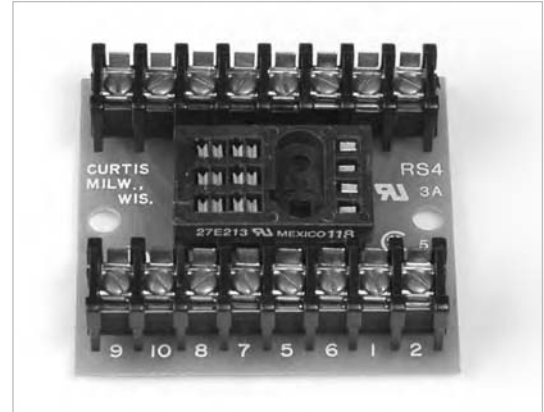

## RS12 and RS16

12 and 16-Pin Square-Base Relay-Type  
Socket Assemblies

### Specifications:

**Rating:** 10 amps, 250 volts

**Track:** TR3

48" length holds up to 16 RS12 sockets

48" length holds up to 22 RS16 sockets

**No. of Terminals:** RS12 and RS16 – No. 6-32 screws, 7/16" center-to-center spacing

**Wire:** RS12 and RS16 – up to No. 12 AWG (lugs are recommended on wire larger than No. 16AWG)

**Sockets:** RS12 – 11 pin receptacle to accept 3PDT relays

RS16 – 8-pin receptacle to accept 2PDT relays

**Note:** RS12 – CSA rating is 10 amps, 125 volts

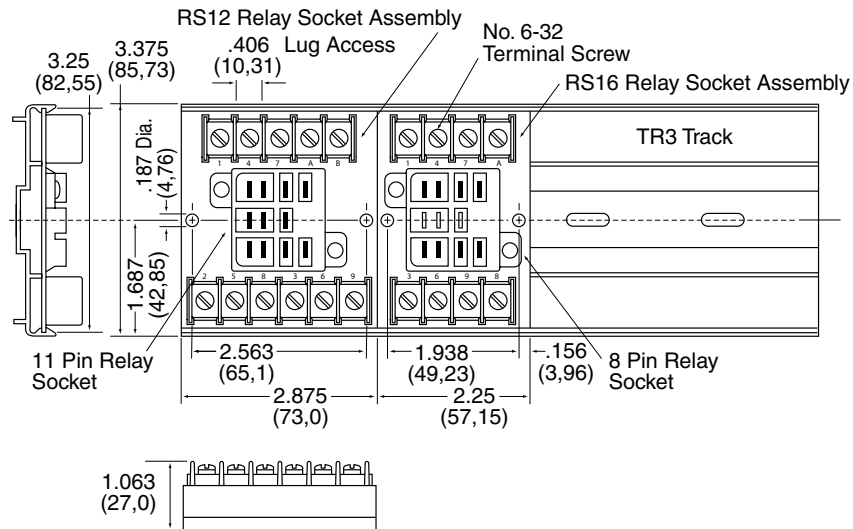

## RS14

### 14-Pin Square-Base Miniature Relay-Type Socket Assemblies

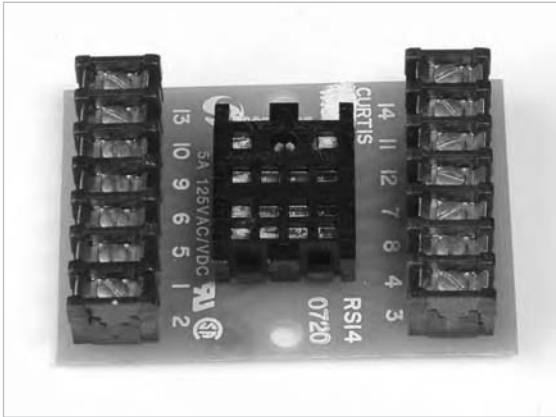

### Specifications:

**Rating:** 5 amps, 125 volts

**Track:** TR2

48" length holds up to 16 sockets

**No. of Terminals:** No. 2-56 screws with clamps (1/4" center-to-center spacing)

**Wire:** up to two No. 16AWG

**Sockets:** 14-pin receptacle to accept miniature 4PDT relays

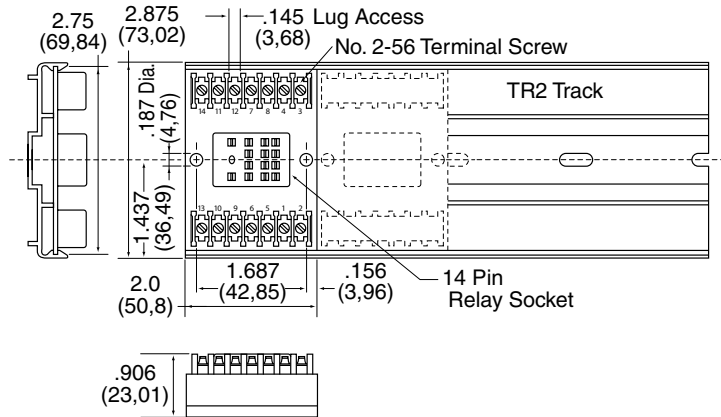

## RS15

### 15-Pin Square-Base Grounded Miniature Relay-Type Socket Assemblies

### Specifications:

**Rating:** 5 amps, 125 volts

**Track:** TR1

48" length holds up to 21 sockets

**No. of Terminals:** No. 2-56 screws with clamp (1/4" center-to-center spacing)

**Wire:** Up to No. 16AWG

**Sockets:** 15-pin receptacle to accept grounded miniature 4PDT relays

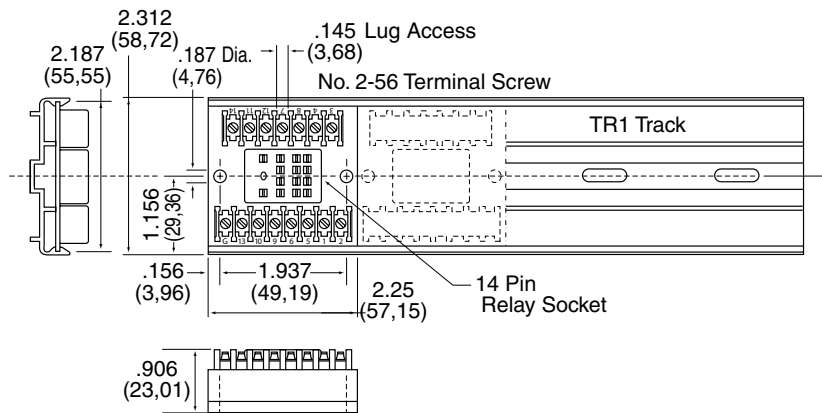
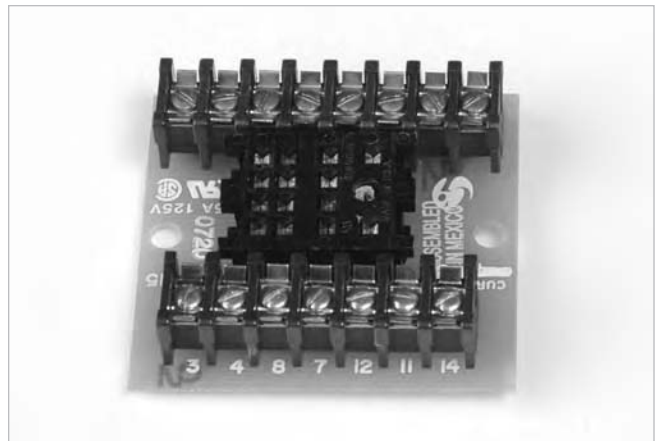



# RS & CUS Series

## ACCESSORIES



- 18836 – (RS2 socket only)
- 18837 – (RS4 socket only)
- 18838 – (RS6 socket only)
- 18830 – (RS14 & 15 socket only)
- 18831 – (RS12 socket only)
- 18835 – Round 11-pin socket (RS11)
- 18821 – Round octal socket (RS8)
- 18832 – Square 8-pin socket (RS16)
- 44613 – Tie down bail (CUS5, 12, 16)
- 44617 – Relay hold down clip (CUS5, 12, 16)
- 62610 – TR track end clips



# DIN RAIL TERMINAL BLOCKS

*Screw Connection*

*Screwless Connection*

*Fuse Blocks*

*Ground Blocks*

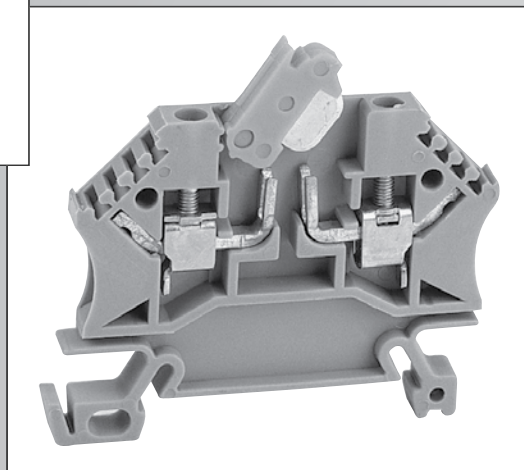
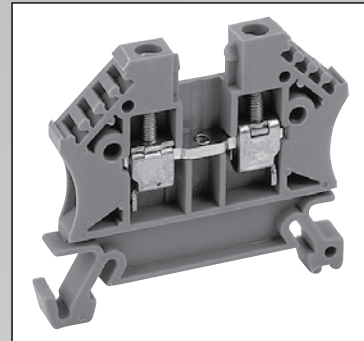

# DIN Rail Terminal Blocks

## Features:

- Mounts on industry standard DIN 35 mm rail
- Vibration resistant clamp design
- Large contact surface results in higher wire retention force
- Functional reliability after repeated tightening and loosening

### Enclosed Guide Slot for Screwdriver

- Safety during installation
- Prevents the screwdriver blade from slipping particularly in the case of automatic screw drivers

### Labeling

- Not concealed by the conductor
- Simplifies identification/assignment during maintenance
- Snap-in preprinted marker

### Conductor Entry Funnel

- Ease of operation and speed by guiding the conductor during terminal connection
- Tongue design prevents wire insertion under clamp

### Elastic Clamping Parts Folded at the Bottom

- Vibration proof connection
- Lock washer action keeps screws from coming loose
- Clamps provided in open position
- Serrations on current bar provide reliable contact
- Clamps are zinc-galvanized and chrome-plated steel

### Screw Locking Element

- Captive screw design
- Steel screws instead of soft brass
- Screws are hardened steel zinc-galvanized and chrome-plated

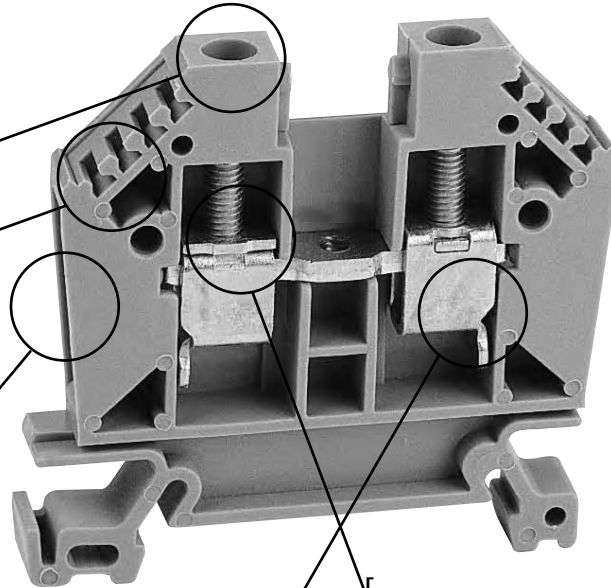

## APPROVALS

All our products have the following marks in accordance with their own features.



All products show in this leadlet which are subject to the Electrical Sector Directives have the CE Mark.



# Multiple Wire Connections per UL

DIN Rail Terminal Blocks		Wire Size AWG (mm) Number of the same size wire per terminal block															Catalog Page Number	
Part Number	UL Rating	#24 -	#22 -	#20 (0.5)	#18 (0.75)	#16 (1.5)	#14 (2.5)	#12 (4)	#10 (6)	#8 (10)	#6 (16)	#4 (25)	#2 (35)	#1 (40)	1/0 (50)	2/0 (70)		3/0 (80)
<b>6102000</b>	24-12	4	4	3	2	2	1	1	-	-	-	-	-	-	-	-	-	64
<b>6102050</b>	22-12	-	3	3	2	2	1	1	-	-	-	-	-	-	-	-	-	75
<b>6102100</b>	24-12	1	1	1	1	1	1	1	-	-	-	-	-	-	-	-	-	71
<b>6102300</b>	24-12	1	1	1	1	1	1	1	-	-	-	-	-	-	-	-	-	71
<b>6102310</b>	24-12	1	1	1	1	1	1	1	-	-	-	-	-	-	-	-	-	71
<b>6104000</b>	24-10	4	4	4	3	2	2	1	1	-	-	-	-	-	-	-	-	64
<b>6104100</b>	24-10	1	1	1	1	1	1	1	1	-	-	-	-	-	-	-	-	71
<b>6104110</b>	24-10	4	4	3	3	2	2	1	1	-	-	-	-	-	-	-	-	74
<b>6104300</b>	24-10	4	4	4	3	2	2	1	1	-	-	-	-	-	-	-	-	76
<b>6104310</b>	22-8	-	-	4	4	3	2	2	1	1	-	-	-	-	-	-	-	76
<b>6104320</b>	20-8	-	-	4	4	3	2	2	1	1	-	-	-	-	-	-	-	76
<b>6104330</b>	14-4	-	-	-	-	-	4	3	2	2	1	1	-	-	-	-	-	77
<b>6104340</b>	14-2	-	-	-	-	-	3	2	2	2	1	1	1	1	1	-	-	77
<b>6104500</b>	24-10	4	4	3	3	2	2	1	1	-	-	-	-	-	-	-	-	74
<b>6104600</b>	24-10	4	4	3	3	2	2	1	1	-	-	-	-	-	-	-	-	74
<b>6106000</b>	22-8	-	4	4	4	3	2	2	1	1	-	-	-	-	-	-	-	64
<b>6106100</b>	22-8	-	1	1	1	1	1	1	1	1	-	-	-	-	-	-	-	71
<b>6110000</b>	20-6	-	-	4	4	3	3	2	2	1	1	-	-	-	-	-	-	65
<b>6110010</b>	20-6	-	-	4	4	3	3	2	2	1	1	-	-	-	-	-	-	75
<b>6110110</b>	20-6	-	-	4	4	3	3	2	2	1	1	-	-	-	-	-	-	75
<b>6116000</b>	14-4	-	-	-	-	-	4	3	2	2	1	1	-	-	-	-	-	65
<b>6135000</b>	14-1/0	-	-	-	-	-	3	2	2	2	1	1	1	1	1	-	-	65
<b>6170000</b>	4-3/0	-	-	-	-	-	-	-	-	-	-	1	1	1	1	1	1	65
<b>6202100</b>	24-12	1	1	1	1	1	1	1	1	-	-	-	-	-	-	-	-	72
<b>6204000</b>	24-10	4	4	3	3	2	2	1	1	-	-	-	-	-	-	-	-	66
<b>6204010</b>	24-10	4	4	3	3	2	2	1	1	-	-	-	-	-	-	-	-	67
<b>6204100</b>	24-10	1	1	1	1	1	1	1	1	-	-	-	-	-	-	-	-	67
<b>6204110</b>	24-10	4	4	3	3	2	2	1	1	-	-	-	-	-	-	-	-	68
<b>6204130</b>	24-10	4	4	3	3	2	2	1	1	-	-	-	-	-	-	-	-	68
<b>6204200</b>	24-10	4	4	3	3	2	2	1	1	-	-	-	-	-	-	-	-	67
<b>6204210</b>	24-10	1	1	1	1	1	1	1	1	-	-	-	-	-	-	-	-	67
<b>6302000</b>	26-14	4	3	2	2	1	1	-	-	-	-	-	-	-	-	-	-	69
<b>6302100</b>	26-14	4	3	2	2	1	1	-	-	-	-	-	-	-	-	-	-	69
<b>6302110</b>	26-14	4	3	2	2	1	1	-	-	-	-	-	-	-	-	-	-	69
<b>6302120</b>	26-14	4	3	2	2	1	1	-	-	-	-	-	-	-	-	-	-	69
<b>6402000</b>	24-12	1	1	1	1	1	1	1	-	-	-	-	-	-	-	-	-	73
<b>6404000</b>	24-10	1	1	1	1	1	1	1	1	-	-	-	-	-	-	-	-	73
<b>6206000</b>	22-8	-	1	1	1	1	1	1	1	1	-	-	-	-	-	-	-	73
<b>6504000</b>	24-10	4	3	3	2	2	1	1	1	-	-	-	-	-	-	-	-	66
<b>6504010</b>	18-10	-	-	-	3	2	2	1	1	-	-	-	-	-	-	-	-	77

DIN TERMINAL BLOCKS



## Screw Connection Single Level

- **Plastic Body:** Polyamide 6.6
- **Internal Bus:** Nickel-plated brass
- **Clamp:** Hardened steel, electro-plated with zinc yellow-chromated
- **Screws:** Steel, zinc-plated and yellow-chromated
- **Marking:** 4 slots on both sides
- **Tracking Resistance:**  
IEC 112: CTI > 600  
VDE 0303: KB > 600

### 6102000 2.5/5 Feed Through

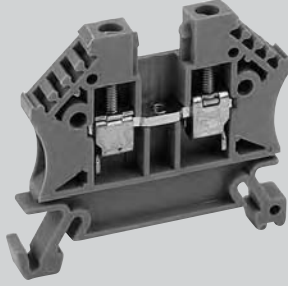

### 6104000 4/6 Feed Through

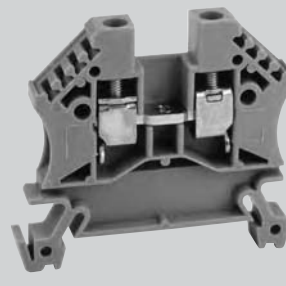

### 6106000 6/8 Feed Through

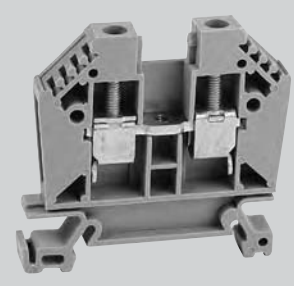

	6102000	6104000	6106000
<b>Dimensions</b>	44 mm (L) x 36 mm (H) x 5 mm (W)	44 mm (L) x 36 mm (H) x 6 mm (W)	50 mm (L) x 44 mm (H) x 7 mm (W)
<b>Opening</b>	3.6 x 2.6 mm	4 x 3.3 mm	5 x 4 mm
<b>Stripping Length</b>	10 mm	10 mm	12 mm
<b>Screw Thread</b>	M 2.6	M 3	M 3.5
<b>Central Thread</b>	M 2.5	M 3	M 3
<b>Connecting Capacity</b>	Solid conductors mm <sup>2</sup> 0.5-4 Stranded conductors mm <sup>2</sup> 0.5-2.5	Solid conductors mm <sup>2</sup> 0.5-4 Stranded conductors mm <sup>2</sup> 0.5-4	Solid conductors mm <sup>2</sup> 0.5-10 Stranded conductors mm <sup>2</sup> 0.5-6
<b>Conductors with Ferrules</b>	DIN 46288 / 1 mm <sup>2</sup> 0.5-2.5	DIN 46288 / 1 mm <sup>2</sup> 0.5-4	DIN 46288 / 1 mm <sup>2</sup> 0.5-6
<b>Number of Connectable Conductors</b>	2 x 1.5 mm <sup>2</sup> 4 x 1.0 mm <sup>2</sup>	4 x 1.5 mm <sup>2</sup>	2 x 4 mm <sup>2</sup>
<b>Approvals</b>			
<b>Wire Range</b>	24-12 AWG   24-12 AWG   2.5 mm <sup>2</sup>	24-10 AWG   24-10 AWG   4 mm <sup>2</sup>	22-8 AWG   22-8 AWG   10 mm <sup>2</sup>
<b>Voltage Rating</b>	600V   600V   800V	600V   600V   800V	600V   600V   800V
<b>Current Rating</b>	20A   20A   20A	30A   30A   32A	50A   50A   41A
<b>Tightening Torque</b>	Max. 0.5 Nm	Max. 0.6 Nm	Max. 1.2 Nm
<b>Gauges</b>	A3	A4	A5
<b>ACCESSORIES</b>	<b>Cat. No.</b>	<b>Cat. No.</b>	<b>Cat. No.</b>
<b>Available Colors</b>	6102000 – Gray 6102001 – Blue 6102002 – Black 6102003 – Brown 6102004 – Yellow-Green 6102005 – Green 6102006 – Yellow 6102007 – Orange 6102008 – Red 6102009 – White	6104000 – Gray 6104001 – Blue 6104002 – Black 6104003 – Brown 6104004 – Yellow-Green 6104005 – Green 6104006 – Yellow 6104007 – Orange 6104008 – Red 6104009 – White	6106000 – Gray 6106001 – Blue 6106004 – Yellow-Green 6106005 – Green 6106006 – Yellow 6106007 – Orange 6106008 – Red
<b>End Plate</b> Qty. pk. 10	6800010 – 44 mm (L) x 35 mm (H) x 1.5 mm (W)	6800010 – 44 mm (L) x 35 mm (H) x 1.5 mm (W)	6800011 – 50 mm (L) x 43 mm (H) x 1.5 mm (W)
<b>Separator</b> Qty. pk. 100	6800051 – 55 mm (L) x 44 mm (H) x 1.5 mm (W)	6800051 – 55 mm (L) x 44 mm (H) x 1.5 mm (W)	6800050 – 55 mm (L) x 49 mm (H) x 1.5 mm (W)
<b>Cover</b> Qty. pk. 100	6800075 – 47 mm (L) x 24.5 mm (H) x 4.8 mm (W)	6800076 – 47 mm (L) x 24.5 mm (H) x 5.8 mm (W)	6800077 – 53 mm (L) x 26 mm (H) x 6.8 mm (W)
<b>Jumper-Bar Package</b>	6800110 – .5M Jumper Bar	6800120 – .5M Jumper Bar	6800130 – .5M Jumper Bar
<b>Jumpers 2 pole</b>	6800102 – 100 pieces	6800112 – 100 pieces	6800122 – 100 pieces
<b>3 pole</b>	6800103 – 100 pieces	6800113 – 100 pieces	6800123 – 100 pieces
<b>4 pole</b>	6800104 – 100 pieces	6800114 – 100 pieces	6800124 – 100 pieces
<b>End Bracket</b> Qty. pk. 100	6804150 – 58 mm (L) x 36 mm (H) x 9 mm (W)	6804150 – 58 mm (L) x 36 mm (H) x 9 mm (W)	6804150 – 58 mm (L) x 36 mm (H) x 9 mm (W)
<b>Test Plug Adapter (red)</b>		6800501 – dia. 2.8 mm	6800501 – dia. 2.8 mm
<b>Test Plug Adapter (black)</b>		6800500 – dia. 2.8 mm	6800500 – dia. 2.8 mm





### 6110000 10/9 Feed Through

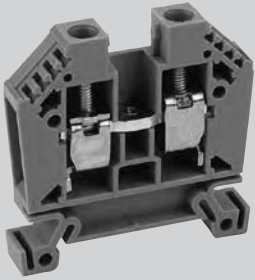

50 mm (L) x 44 mm (H) x  
9 mm (W)

6 x 5.5 mm

12 mm

M 4

M 3

Solid conductors mm<sup>2</sup> 1.5-16  
Stranded conductors  
mm<sup>2</sup> 1.5-10

DIN 46288 / 1 mm<sup>2</sup> 1.5-10

2 x 6 mm<sup>2</sup>



20-6 AWG	20-6 AWG	10 mm <sup>2</sup>
600V	600V	800V
65A	65A	57A

Max 2.0 Nm

B6

**Cat. No.**

**6110000** – Gray  
**6110001** – Blue  
**6110004** – Yellow-Green  
**6110005** – Green  
**6110006** – Yellow  
**6110007** – Orange

### 6116000 16-25/12 Feed Through

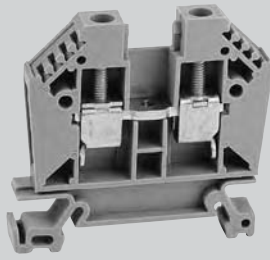

56 mm (L) x 49 mm (H) x  
12 mm (W)

7 x 7.4 mm

14 mm

M 5

M 4

Solid conductors mm<sup>2</sup> 1.5-25  
Stranded conductors  
mm<sup>2</sup> 1.5-10

DIN 46288 / 1 mm<sup>2</sup> 1.5-25

2 x 10 mm<sup>2</sup>



14-4 AWG	14-4 AWG	25 mm <sup>2</sup>
600V	600V	800V
85A	85A	101A

Max 3.0 Nm

B7

**Cat. No.**

**6116000** – Gray  
**6116001** – Blue  
**6116004** – Yellow-Green  
**6116006** – Yellow

### 6135000 35-50/16 Feed Through



62 mm (L) x 61 mm (H) x  
16 mm (W)

11 x 10 mm

17 mm

M 6

M 4

Solid conductors mm<sup>2</sup> 2.5-50  
Stranded conductors  
mm<sup>2</sup> 2.5-50

DIN 46288 / 1 mm<sup>2</sup> 2.5-50

2 x 25 mm<sup>2</sup>



14-1/0 AWG	14-1/0 AWG	50 mm <sup>2</sup>
600V	600V	800V
130A	130A	150A

Max 5.0 Nm

B9

**Cat. No.**

**6135000** – Gray  
**6135001** – Blue  
**6135004** – Yellow-Green  
**6135006** – Yellow  
**6135008** – Red

### 6170000 70/26 Feed Through



74 mm (L) x 75 mm (H) x  
26 mm (W)

15.5 x 16.5 mm

26 mm

M 3

Solid conductors mm<sup>2</sup> 16-70  
Stranded conductors  
mm<sup>2</sup> 16-70

DIN 46288 / 1 mm<sup>2</sup> 16-70

2 x 50 mm<sup>2</sup>



4-3/0 AWG	4-3/0 AWG	70 mm <sup>2</sup>
600V	600V	800V
185A	185A	192A

Max 10.0 Nm

B11

**Cat. No.**

**6170000** – Gray  
**6170001** – Blue  
**6170004** – Yellow-Green  
**6170006** – Yellow

**6800011** – 50 mm (L) x  
43 mm (H) x 1.5 mm (W)

**6800050** – 55 mm (L) x  
49 mm (H) x 1.5 mm (W)

**6800077** – 53 mm (L) x  
26 mm (H) x 6.8 mm (W)

**6800140** – .5M Jumper Bar

**6800132** – 100 pieces  
**6800133** – 100 pieces  
**6800134** – 100 pieces

**6804150** – 58 mm (L) x  
36 mm (H) x 9 mm (W)

**6800501** – dia. 2.8 mm

**6800500** – dia. 2.8 mm

**6800012** – 44 mm (L) x  
35 mm (H) x 1.5 mm (W)

**6800078** – 59 mm (L) x  
26 mm (H) x 11.5 mm (W)

**6800150** – .5M Jumper Bar

**6800142** – 100 pieces  
**6800143** – 100 pieces  
**6800144** – 100 pieces

**6804150** – 58 mm (L) x  
36 mm (H) x 9 mm (W)

**6800013** – 62 mm (L) x  
60 mm (H) x 1.5 mm (W)

**6800079** – 59 mm (L) x  
26 mm (H) x 15.5 mm (W)

**6800160** – .5M Jumper Bar

**6800152** – 100 pieces  
**6800153** – 100 pieces  
**6800154** – 100 pieces

**6804150** – 58 mm (L) x  
36 mm (H) x 9 mm (W)

**6804150** – 58 mm (L) x  
36 mm (H) x 9 mm (W)



## Screw Connection Single Level

- **Plastic Body:** Polyamide 6.6
- **Internal Bus:** Nickel-plated brass
- **Clamp:** Hardened steel, electro-plated with zinc yellow-chromated
- **Screws:** Steel, zinc-plated and yellow-chromated
- **Marking:** 4 slots on both sides
- **Tracking Resistance:**  
IEC 112: CTI > 600  
VDE 0303: KB > 600

## 6504000 4/15 Mini Feed Through

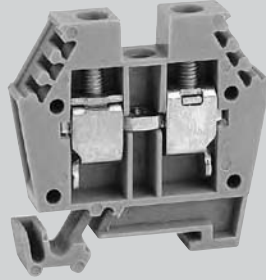

## Screw Connection Dual Level

- **Plastic Body:** Polyamide 66.6 VO
- **Internal Bus:** Silver plated copper
- **Clamp:** Hardened steel, electro-plated with zinc yellow chromated
- **Screws:** Steel, zinc plated and yellow chromated
- **Marking:** 4 slots on both sides
- **Tracking Resistance:**  
IEC 112: CTI > 600  
VDE 0303: KB > 600

## 6204000 D 4-2/6 Feed Through

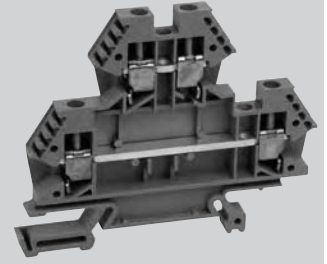

<b>Dimensions</b>	32 mm (L) x 28 mm (H) x 6 mm (W)			<b>Dimensions</b>	72 mm (L) x 55 mm (H) x 6 mm (W)		
<b>Opening</b>	4 x 3.3 mm			<b>Opening</b>	4 x 3.3 mm		
<b>Stripping Length</b>	10 mm			<b>Stripping Length</b>	10 mm		
<b>Screw Thread</b>	M 3			<b>Terminal Screw</b>	M 3		
<b>Central Thread</b>				<b>Terminal Screw</b>	M 3		
<b>Connecting Capacity</b>	Solid conductors mm <sup>2</sup> 0.5-6 Stranded conductors mm <sup>2</sup> 0.5-4			<b>Connecting Capacity</b>	Solid conductors mm <sup>2</sup> 0.5-6 Stranded conductors mm <sup>2</sup> 0.5-4		
<b>Conductors with Ferrules</b>	DIN 46288 / 1 mm <sup>2</sup> 0.5-4			<b>Conductors with Ferrules</b>	DIN 46288 / 1 mm <sup>2</sup> 0.5-4		
<b>Number of Connectable Conductors</b>	4 x 1.5 mm <sup>2</sup>			<b>Number of Connectable Conductors</b>	4 x 1.5 mm <sup>2</sup>		
<b>Approvals</b>				<b>Approvals</b>			
<b>Wire Range</b>	24-10 AWG	24-10 AWG	4 mm <sup>2</sup>	<b>Wire Range</b>	24-10 AWG	24-10 AWG	4 mm <sup>2</sup>
<b>Voltage Rating</b>	300V	300V	400V	<b>Voltage Rating</b>	600V	600V	800V
<b>Current Rating</b>	30A	30A	32A	<b>Current Rating</b>	30A	30A	32A
<b>Tightening Torque</b>	Max. 0.6 Nm			<b>Tightening Torque</b>	Max. 0.6 Nm		
<b>Gauges</b>	A4			<b>Gauges</b>	A4		
<b>ACCESSORIES</b>	<b>Cat. No.</b>			<b>ACCESSORIES</b>	<b>Cat. No.</b>		
<b>Available Colors</b>	6504000 – Gray 6504001 – Blue 6504002 – Black 6504004 – Yellow-Green 6504005 – Green 6504006 – Yellow 6504007 – Orange 6504008 – Red			<b>Available Colors</b>	6204000 – Gray 6204001 – Blue 6204002 – Black 6204003 – Brown 6204004 – Yellow-Green 6204005 – Green 6204006 – Yellow 6204007 – Orange 6204008 – Red 6204009 – White		
<b>End Plate</b> Qty. pk. 10	6800017 – 44 mm (L) x 35 mm (H) x 1.5 mm (W)			<b>End Plate</b> Qty. pk. 10	6800014 – 72 mm (L) x 55 mm (H) x 1.5 mm (W)		
<b>Separator</b> Qty. pk. 100				<b>Cover</b> Qty. pk. 100	6800080 – 36 mm (L) x 14 mm (H) x 6 mm (W)		
<b>Cover</b> Qty. pk. 100	6800081 – 47 mm (L) x 24.5 mm (H) x 4.8 mm (W)			<b>Jumper-Bar Package</b>	6800190 – .5M Jumper Bar		
<b>Jumper-Bar Package</b>	6800190 – .5M Jumper Bar			<b>Jumpers 2 pole</b>	6800182 – 100 pieces		
<b>Jumpers 2 pole</b>	6800182 – 100 pieces			<b>3 pole</b>	6800183 – 100 pieces		
<b>3 pole</b>	6800183 – 100 pieces			<b>4 pole</b>	6800184 – 100 pieces		
<b>4 pole</b>	6800184 – 100 pieces			<b>End Bracket</b> Qty. pk. 100	6804150 – 58 mm (L) x 36 mm (H) x 9 mm (W)		
<b>End Bracket</b> Qty. pk. 100	6804500 – 25 mm (L) x 16 mm (H) x 7 mm (W)			<b>Test plug adapter (red)</b>	6800501		
				<b>Test plug adapter (black)</b>	6800500		



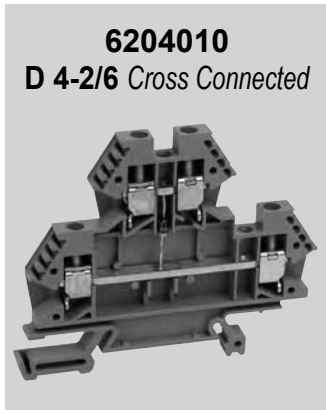

72 mm (L) x 55 mm (H) x  
6 mm (W)

4 x 3.3 mm

10 mm

M 3

Solid conductors mm<sup>2</sup> 0.5-6  
Stranded conductors  
mm<sup>2</sup> 0.5-4

DIN 46288 / 1 mm<sup>2</sup> 0.5-4

4 x 1.5 mm<sup>2</sup>



24-10 AWG	24-10 AWG	4 mm <sup>2</sup>
600V	600V	800V
30A	30A	32A

Max 0.6 Nm

A4

**Cat. No.**

**6204010** – Gray  
**6204011** – Blue  
**6204014** – Yellow-Green  
**6204016** – Yellow

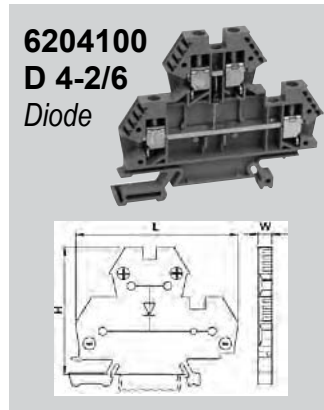

72 mm (L) x 55 mm (H) x  
6 mm (W)

4 x 3.3 mm

10 mm

M 3

Solid conductors mm<sup>2</sup> 0.5-6  
Stranded conductors  
mm<sup>2</sup> 0.5-4

DIN 46288 / 1 mm<sup>2</sup> 0.5-4

4 x 1.5 mm<sup>2</sup>



24-10 AWG	24-10 AWG	4 mm <sup>2</sup>

Max 0.6 Nm

A4

**Cat. No.**

**6204100** – Gray  
**6204101** – Blue

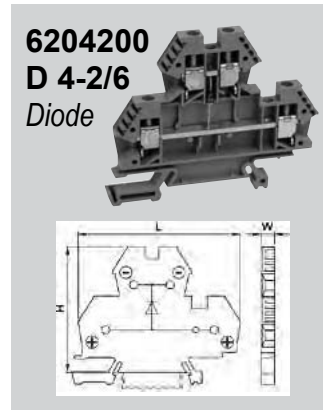

72 mm (L) x 55 mm (H) x  
6 mm (W)

4 x 3.3 mm

10 mm

M 3

Solid conductors mm<sup>2</sup> 0.5-6  
Stranded conductors  
mm<sup>2</sup> 0.5-4

DIN 46288 / 1 mm<sup>2</sup> 0.5-4

4 x 1.5 mm<sup>2</sup>



24-10 AWG	24-10 AWG	4 mm <sup>2</sup>

Max 0.6 Nm

A4

**Cat. No.**

**6204110** – Gray  
**6204111** – Blue

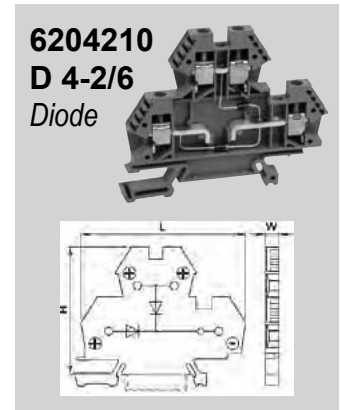

72 mm (L) x 55 mm (H) x  
6 mm (W)

4 x 3.3 mm

10 mm

M 3

Solid conductors mm<sup>2</sup> 0.5-6  
Stranded conductors  
mm<sup>2</sup> 0.5-4

DIN 46288 / 1 mm<sup>2</sup> 0.5-4

4 x 1.5 mm<sup>2</sup>



24-10 AWG	24-10 AWG	4 mm <sup>2</sup>
600V	600V	800V
30A	30A	32A

Max. 0.6 Nm

A4

**Cat. No.**

**43475** – Gray  
Call for P/N – Blue  
Call for P/N – Yellow

**6800014** – 72 mm (L) x  
55 mm (H) x 1.5 mm (W)

**6800080** – 36 mm (L) x  
14 mm (H) x 6 mm (W)

**6800190** – .5M Jumper Bar

**6800182** – 100 pieces

**6800183** – 100 pieces

**6800184** – 100 pieces

**6804150** – 58 mm (L) x  
36 mm (H) x 9 mm (W)

**6800501**

**6800500**

**6800014** – 72 mm (L) x  
55 mm (H) x 1.5 mm (W)

**6800080** – 36 mm (L) x  
14 mm (H) x 6 mm (W)

**6800190** – .5M Jumper Bar

**6800182** – 100 pieces

**6800183** – 100 pieces

**6800184** – 100 pieces

**6804150** – 58 mm (L) x  
36 mm (H) x 9 mm (W)

**6800501**

**6800500**

**6800014** – 72 mm (L) x  
55 mm (H) x 1.5 mm (W)

**6800080** – 36 mm (L) x  
14 mm (H) x 6 mm (W)

**6800190** – .5M Jumper Bar

**6800182** – 100 pieces

**6800183** – 100 pieces

**6800184** – 100 pieces

**6804150** – 58 mm (L) x  
36 mm (H) x 9 mm (W)

**6800501**

**6800500**

**6800014** – 72 mm (L) x  
55 mm (H) x 1.5 mm (W)

**6800080** – 36 mm (L) x  
14 mm (H) x 6 mm (W)

**6800190** – .5M Jumper Bar

**6800182** – 100 pieces

**6800183** – 100 pieces

**6800184** – 100 pieces

**6804150** – 58 mm (L) x  
36 mm (H) x 9 mm (W)

**6800501**

**6800500**



## Screw Connection Dual Level

- **Plastic Body:** Polyamide 66.6 VO
- **Internal Bus:** Silver plated copper
- **Clamp:** Hardened steel, electro-plated with zinc yellow chromated
- **Screws:** Steel, zinc plated and yellow chromated
- **Marking:** 4 slots on both sides
- **Tracking Resistance:**  
IEC 112: CTI > 600  
VDE 0303: KB > 600

### 6204110 D 4-2/6 LED

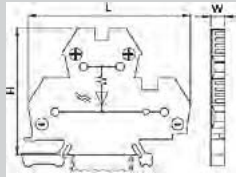

### 6204130 D 4-2/6 LED

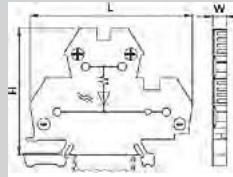
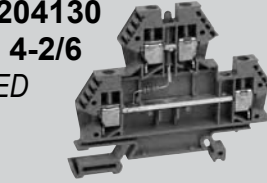

## Screw Connection Triple Level

- **Plastic Body:** Polyamide 66.6 VO
- **Internal Bus:** Silver-plated copper
- **Clamp:** Nickel-plated brass
- **Screws:** Zinc plated and yellow-chromated steel
- **Tracking Resistance:**  
IEC 112: CTI > 600  
VDE 0303: KB > 600

### Dimensions

### Stripping Length

### Connecting Capacity

### Number of Connectable Conductors

### Approvals

### Wire Range

### Voltage Rating

### Current Rating

### Tightening Torque

### Gauges

### ACCESSORIES

### Available Colors

### End Plate Qty. pk. 25

**Jumpers** 2 pole / Blue  
3 pole / Blue  
4 pole / Blue  
12-Pole / Blue  
2 pole / Red  
3 pole / Red  
4 pole / Red  
12-Pole / Red

### End Bracket Qty. pk. 50

### Dimensions

72 mm (L) x 55 mm (H) x  
6 mm (W)

### Opening

4 x 3.3 mm

### Stripping Length

10 mm

### Screw Thread

M 3

### Rating

3, 4 K / 12-24V

### Connecting Capacity

Solid conductors mm<sup>2</sup> 0.5-6  
Stranded conductors  
mm<sup>2</sup> 0.5-4

### Conductors with Ferrules

DIN 46288 / 1 mm<sup>2</sup> 0.5-4

### Number of Connectable Conductors

4 x 1.5 mm<sup>2</sup>

### Approvals



### Wire Range

24-10 AWG | 24-10 AWG | 4 mm<sup>2</sup>

### Voltage Rating

### Current Rating

### Tightening Torque

Max 0.6 Nm

### Gauges

A4

### ACCESSORIES

### Cat. No.

**End Plate**  
Qty. pk. 10

**6800014** – 72 mm (L) x  
55 mm (H) x 1.5 mm (W)

**Cover**  
Qty. pk. 100

**6800080** – 36 mm (L) x  
14 mm (H) x 6 mm (W)

**End Bracket**  
Qty. pk. 100

**6804150** – 58 mm (L) x  
36 mm (H) x 9 mm (W)

72 mm (L) x 55 mm (H) x  
6 mm (W)

4 x 3.3 mm

10 mm

M 3

34 K / 119V

Solid conductors mm<sup>2</sup> 0.5-6  
Stranded conductors  
mm<sup>2</sup> 0.5-4

DIN 46288 / 1 mm<sup>2</sup> 0.5-4

4 x 1.5 mm<sup>2</sup>



24-10 AWG | 24-10 AWG | 4 mm<sup>2</sup>

Max 0.6 Nm

A4

### Cat. No.

**6800014** – 72 mm (L) x  
55 mm (H) x 1.5 mm (W)

**6800080** – 36 mm (L) x  
14 mm (H) x 6 mm (W)

**6804150** – 58 mm (L) x  
36 mm (H) x 9 mm (W)



**6302000**  
**T 2.5/5.3**  
*Feed Through*

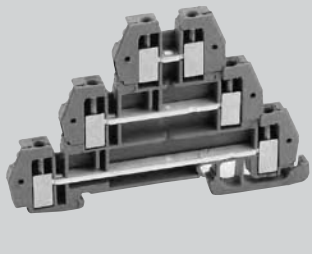

78.5 mm (L) x 47.5 mm (H) x 5.3 mm (W)

7 mm

Solid conductors mm<sup>2</sup> 0.5-4  
 Stranded conductors mm<sup>2</sup> 0.5-2.5

2 x 1.5 mm<sup>2</sup>



26-14 AWG	26-14 AWG	2.5 mm <sup>2</sup>
-----------	-----------	---------------------

300V	300V	250V
------	------	------

10A	10A	24A
-----	-----	-----

Max. 0.5 Nm

A2

**Cat. No.**

**6302000** – Gray

**6800015** – 55.4 mm (L) x 50 mm (H) x 1.5 mm (W)

- 6800192** – 100 pieces
- 6800193** – 100 pieces
- 6800194** – 100 pieces
- 6800200** – 10 pieces
- 6800202** – 100 pieces
- 6800203** – 100 pieces
- 6800204** – 100 pieces
- 6800300** – 10 pieces

**6804150** – 58 mm (L) x 36 mm (H) x 9 mm (W)

**6302100**  
**T 2.5/5.3**

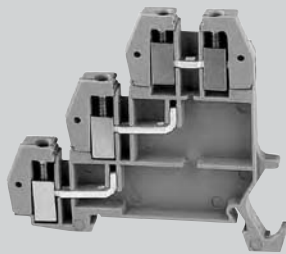

62 mm (L) x 47.5 mm (H) x 5.3 mm (W)

7 mm

Solid conductors mm<sup>2</sup> 0.5-4  
 Stranded conductors mm<sup>2</sup> 0.5-2.5

2 x 1.5 mm<sup>2</sup>



26-14 AWG	26-14 AWG	2.5 mm <sup>2</sup>
-----------	-----------	---------------------

300V	300V	250V
------	------	------

10A	10A	24A
-----	-----	-----

Max. 0.5 Nm

A2

**Cat. No.**

**6302100** – Gray

**6800016** – 55.4 mm (L) x 50 mm (H) x 1.5 mm (W)

- 6800192** – 100 pieces
- 6800193** – 100 pieces
- 6800194** – 100 pieces
- 6800200** – 10 pieces
- 6800202** – 100 pieces
- 6800203** – 100 pieces
- 6800204** – 100 pieces
- 6800300** – 10 pieces

**6804150** – 58 mm (L) x 36 mm (H) x 9 mm (W)

**6302110**  
**T 2.5/5.3**  
*PNP LED Sensor*

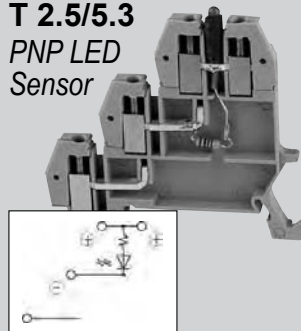

62 mm (L) x 47.5 mm (H) x 5.3 mm (W)

7 mm

Solid conductors mm<sup>2</sup> 0.5-4  
 Stranded conductors mm<sup>2</sup> 0.5-2.5

2 x 1.5 mm<sup>2</sup>



26-14 AWG	26-14 AWG	2.5 mm <sup>2</sup>
-----------	-----------	---------------------

Max. 0.5 Nm

A2

**Cat. No.**

**66302110** – Gray

**6800016** – 55.4 mm (L) x 50 mm (H) x 1.5 mm (W)

- 6800192** – 100 pieces
- 6800193** – 100 pieces
- 6800194** – 100 pieces
- 6800200** – 10 pieces
- 6800202** – 100 pieces
- 6800203** – 100 pieces
- 6800204** – 100 pieces
- 6800300** – 10 pieces

**6804150** – 58 mm (L) x 36 mm (H) x 9 mm (W)

**6302120**  
**T 2.5/5.3**  
*NPN LED Sensor*

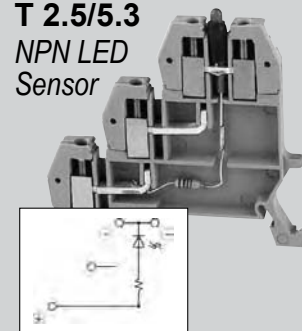

62 mm (L) x 42.5 mm (H) x 5.3 mm (W)

7 mm

Solid conductors mm<sup>2</sup> 0.5-4  
 Stranded conductors mm<sup>2</sup> 0.5-2.5

2 x 1.5 mm<sup>2</sup>



26-14 AWG	26-14 AWG	2.5 mm <sup>2</sup>
-----------	-----------	---------------------

Max 0.5 Nm

A2

**Cat. No.**

**6302120** – Gray

**6800016** – 55.4 mm (L) x 50 mm (H) x 1.5 mm (W)

- 6800192** – 100 pieces
- 6800193** – 100 pieces
- 6800194** – 100 pieces
- 6800200** – 10 pieces
- 6800202** – 100 pieces
- 6800203** – 100 pieces
- 6800204** – 100 pieces
- 6800300** – 10 pieces

**6804150** – 58 mm (L) x 36 mm (H) x 9 mm (W)





## Screwless Single Level

- **Plastic Body:** Polyamide 66.6 VO
- **Internal Bus:** Tin-plated copper
- **Spring:** Stainless steel
- **Tracking Resistance:**  
IEC 112: CT1 > 600  
VDE 0303: KB > 600

### 6102100 2.5/5 Feed Through

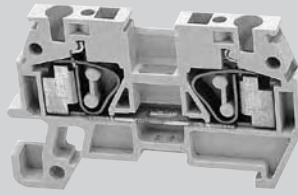

### 6104100 4/6 Feed Through

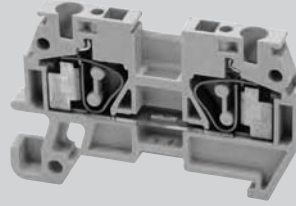

### 6106100 6/8 Feed Through

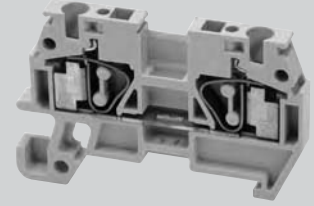

	6102100			6104100			6106100		
<b>Dimensions</b>	53 mm (L) x 28.5 mm (H) x 5 mm (W)			58 mm (L) x 34.5 mm (H) x 6 mm (W)			63 mm (L) x 36.5 mm (H) x 8 mm (W)		
<b>Stripping Length</b>	12 mm			15 mm			18 mm		
<b>Connecting Capacity</b>	Solid conductors mm <sup>2</sup> 1-2.5 Stranded conductors mm <sup>2</sup> 1-2.5			Solid conductors mm <sup>2</sup> 1.5-4 Stranded conductors mm <sup>2</sup> 1.5-4			Solid conductors mm <sup>2</sup> 2.5-6 Stranded conductors mm <sup>2</sup> 2.5-6		
<b>Gauges</b>	A3			A4			A5		
<b>Approvals</b>									
<b>Wire Range</b>	24-12 AWG	24-12 AWG	2.5 mm <sup>2</sup>	24-10 AWG	24-10 AWG	4 mm <sup>2</sup>	22-8 AWG	22-8 AWG	
<b>Voltage Rating</b>	600V	600V	630V	600V	600V	630V	600V	600V	630V
<b>Current Rating</b>	20A	20A	24A	30A	30A	32A	50A	50A	41A
<b>ACCESSORIES</b>	<b>Cat. No.</b>			<b>Cat. No.</b>			<b>Cat. No.</b>		
<b>Available Colors</b>	6102100 – Gray 6102101 – Blue			6104100 – Gray 6104101 – Blue			6106100 – Gray 6106101 – Blue		
<b>End Plate</b> Qty. pk. 25	6800030 – 50 mm (L) x 23 mm (H) x 1.5 mm (W)			6800021 – 50 mm (L) x 23 mm (H) x 1.5 mm (W)			6800022 – 50 mm (L) x 23 mm (H) x 1.5 mm (W)		
<b>End Bracket</b> Qty. pk. 50	6804150 – 58 mm (L) x 36 mm (H) x 9 mm (W)			6804150 – 58 mm (L) x 36 mm (H) x 9 mm (W)			6804150 – 58 mm (L) x 36 mm (H) x 9 mm (W)		
<b>Jumper-Bar</b> Qty. pk. 10	6801050			6801050					



## Screwless Single-Multi Level

- **Plastic Body:** Polyamide 66.6 VO
- **Internal Bus:** Tin-plated copper
- **Spring:** Stainless steel
- **Tracking Resistance:**  
IEC 112: CTI > 600  
VDE 0303: KB > 600

### 6102300 2.5/5 Feed Through

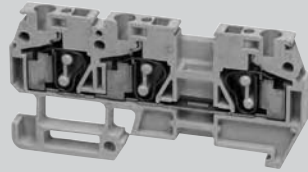

### 6102310 2.5/5 Feed Through

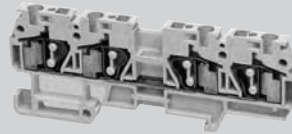

### 6202100 6/8 Feed Through

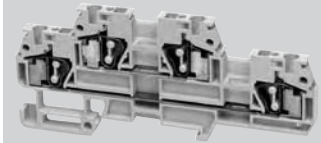

<b>Dimensions</b>	68.5 mm (L) x 28.5 mm (H) x 5 mm (W)			87.5 mm (L) x 28.5 mm (H) x 5 mm (W)			98 mm (L) x 37.5 mm (H) x 5 mm (W)		
<b>Stripping Length</b>	12 mm			12 mm			12 mm		
<b>Connecting Capacity</b>	Solid conductors mm <sup>2</sup> 1-2.5 Stranded conductors mm <sup>2</sup> 1-2.5			Solid conductors mm <sup>2</sup> 1-2.5 Stranded conductors mm <sup>2</sup> 1-2.5			Solid conductors mm <sup>2</sup> 1-2.5 Stranded conductors mm <sup>2</sup> 1-2.5		
<b>Gauges</b>	A3			A3					
<b>Approvals</b>									
<b>Wire Range</b>	24-12 AWG	24-12 AWG		24-12 AWG	24-12 AWG		24-12 AWG	24-12 AWG	
<b>Voltage Rating</b>	600V	600V	630V	600V	600V	630V	600V	600V	630V
<b>Current Rating</b>	20A	20A	24A	20A	20A	24A	20A	20A	24A
<b>ACCESSORIES</b>	<b>Cat. No.</b>			<b>Cat. No.</b>			<b>Cat. No.</b>		
<b>Available Colors</b>	6102300 – Gray 6102301 – Blue			6102100 – Gray			6102100 – Gray		
<b>End Plate</b> Qty. pk. 25	6800025 – 50 mm (L) x 23 mm (H) x 1.5 mm (W)			6800026 – 50 mm (L) x 23 mm (H) x 1.5 mm (W)			6800027 – 50 mm (L) x 23 mm (H) x 1.5 mm (W)		
<b>End Bracket</b> Qty. pk. 50	6804150 – 58 mm (L) x 36 mm (H) x 9 mm (W)			6804150 – 58 mm (L) x 36 mm (H) x 9 mm (W)			6804150 – 58 mm (L) x 36 mm (H) x 9 mm (W)		
<b>Jumper-Bar</b> Qty. pk. 10	6801050			6801050			6801050		



## Screwless Ground

- **Plastic Body:** Polyamide 66.6 VO
- **Internal Bus:** Tin-plated copper
- **Spring:** Stainless steel
- **Foot:** Tin-plated brass
- **Tracking Resistance:**  
IEC 112: CTI > 600  
VDE 0303: KB > 600

### 6402000 2.5/5

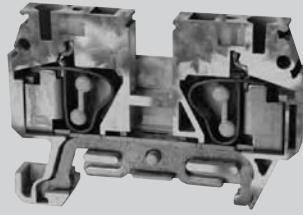

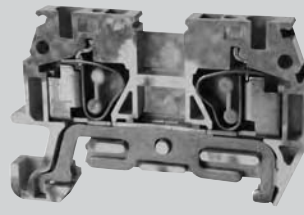

### 6404000 4/6

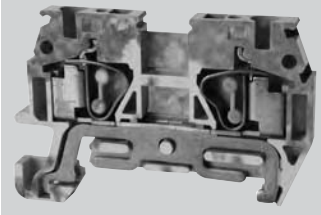

### 6406000 6/8



Dimensions	53 mm (L) x 28.5 mm (H) x 5 mm (W)	58 mm (L) x 34.5 mm (H) x 6 mm (W)	63 mm (L) x 36.5 mm (H) x 8 mm (W)
Stripping Length	12 mm	15 mm	15 mm
Connecting Capacity	Solid conductors mm <sup>2</sup> 1-2.5 Stranded conductors mm <sup>2</sup> 1-2.5	Solid conductors mm <sup>2</sup> 1-2.4 Stranded conductors mm <sup>2</sup> 1-2.4	Solid conductors mm <sup>2</sup> 2.5-6 Stranded conductors mm <sup>2</sup> 2.5-6
Gauges	A3	A4	A5
Approvals			
Wire Range	24-12 AWG   24-12 AWG   2.5 mm <sup>2</sup>	24-10 AWG   24-10 AWG   4 mm <sup>2</sup>	22-8 AWG   22-8 AWG   6 mm <sup>2</sup>
Voltage Rating			
Current Rating			
ACCESSORIES	<b>Cat. No.</b>	<b>Cat. No.</b>	<b>Cat. No.</b>
<b>Available Colors</b>	6402000 – Yellow-Green	6404000 – Yellow-Green	64062000 – Yellow-Green
<b>End Plate</b> Qty. pk. 25	6800020 – 50 mm (L) x 23 mm (H) x 1.5 mm (W)	6800021 – 50 mm (L) x 23 mm (H) x 1.5 mm (W)	6800022 – 50 mm (L) x 23 mm (H) x 1.5 mm (W)
<b>End Bracket</b> Qty. pk. 50	6804150 – 58 mm (L) x 36 mm (H) x 9 mm (W)	6804150 – 58 mm (L) x 36 mm (H) x 9 mm (W)	6804150 – 58 mm (L) x 36 mm (H) x 9 mm (W)



## Fuse

- **Plastic Body:** Polyamide 6.6
- **Clamp:** Hardened steel, electro-plated with zinc yellow chromated
- **Screws:** Steel, zinc plated and yellow chromated
- **Marking:** 4 slots on both sides
- **Tracking Resistance:**  
IEC 112: CTI > 600  
VDE 0303: KB > 600

### 6104500 5x20



### 6104110 5x20 LED



### 6104600 5x20 Disconnect



<b>Dimensions</b>	66 mm (L) x 44 mm (H) x 10 mm (W)			66 mm (L) x 44 mm (H) x 10 mm (W)			66 mm (L) x 44 mm (H) x 10 mm (W)		
<b>Opening</b>	4 x 3.3 mm			4 x 3.3 mm			4 x 3.3 mm		
<b>Stripping Length</b>	10 mm			10 mm			10 mm		
<b>Screw Thread</b>	M 3			M 3			M 3		
<b>Connecting Capacity</b>	Solid conductors mm <sup>2</sup> 0.5-6 Stranded conductors mm <sup>2</sup> 0.5-4			Solid conductors mm <sup>2</sup> 0.5-6 Stranded conductors mm <sup>2</sup> 0.5-4			Solid conductors mm <sup>2</sup> 0.5-6 Stranded conductors mm <sup>2</sup> 0.5-4		
<b>Conductors with Ferrules</b>	DIN 46288 / 1 mm <sup>2</sup> 0.5-4			DIN 46288 / 1 mm <sup>2</sup> 0.5-4			DIN 46288 / 1 mm <sup>2</sup> 0.5-4		
<b>Number of Connectable Conductors</b>	4 x 1.5 mm <sup>2</sup>			4 x 1.5 mm <sup>2</sup>			4 x 1.5 mm <sup>2</sup>		
<b>Gauges</b>	A4			A4			A4		
<b>Approvals</b>									
<b>Wire Range</b>	24-10 AWG	24-10 AWG	4 mm <sup>2</sup>	24-10 AWG	24-10 AWG	4 mm <sup>2</sup>	24-10 AWG	24-10 AWG	
<b>Voltage Rating</b>	300V	300V	500V	300V	300V	500V	300V	300V	
<b>Current Rating</b>	30A	30A		30A	30A		30A	30A	
<b>Tightening Torque</b>	Max 0.6 Nm			Max 0.6 Nm			Max 0.6 Nm		
<b>Lever</b>	Plastic material resistant up to 250° C						Plastic material resistant up to 250° C		
<b>Internal Bus</b>	Silver-plated brass			Silver-plated brass			Silver-plated brass		
<b>Fuse Terminal</b>	Silver-plated bronze			Silver-plated bronze			Silver-plated bronze		
<b>ACCESSORIES</b>	<b>Cat. No.</b>			<b>Cat. No.</b>			<b>Cat. No.</b>		
<b>Available Colors</b>	6104500 – Gray			6104110 – 12-24V 6104120 – 60V 6104130 – 110V 6104140 – 220V			6104600 – Gray		
<b>End Bracket</b> Qty. pk. 50	6804150 – 58 mm (L) x 36 mm (H) x 9 mm (W)			6804150 – 58 mm (L) x 36 mm (H) x 9 mm (W)			6804150 – 58 mm (L) x 36 mm (H) x 9 mm (W)		
							<b>Warning: DO NOT DISCONNECT UNDER LOAD</b>		



## Fuse

- **Plastic Body:** Polyamide 6.6
- **Clamp:** Hardened steel, electroplated with zinc yellow chromated
- **Screws:** Steel, zinc plated and yellow chromated
- **Marking:** 4 slots on both sides
- **Tracking Resistance:**  
IEC 112: CTI > 600  
VDE 0303: KB > 600

### 6110010 1-1/4x1/4



### 6110110 1-1/4x1/4 LED



### 6102050 Knife Disconnect



<b>Dimensions</b>	82 mm (L) x 52 mm (H) x 10 mm (W)			82 mm (L) x 52 mm (H) x 10 mm (W)			52 mm (L) x 35 mm (H) x 5 mm (W)		
<b>Opening</b>	6 x 5.5 mm			6 x 5.5 mm			3.6 x 2.6 mm		
<b>Stripping Length</b>	12 mm			12 mm			10 mm		
<b>Screw Thread</b>	M 4			M 4			M 2.6		
<b>Connecting Capacity</b>	Solid conductors mm <sup>2</sup> 1.5-16 Stranded conductors mm <sup>2</sup> 1.5-10			Solid conductors mm <sup>2</sup> 1.5-16 Stranded conductors mm <sup>2</sup> 1.5-10			Solid conductors mm <sup>2</sup> 0.5-4 Stranded conductors mm <sup>2</sup> 0.5-2.5		
<b>Conductors with Ferrules</b>	DIN 46288 / 1 mm <sup>2</sup> 1.5-10			DIN 46288 / 1 mm <sup>2</sup> 1.5-10			DIN 46288 / 1 mm <sup>2</sup> 0.5-4		
<b>Number of Connectable Conductors</b>	2 x 6 mm <sup>2</sup>			2 x 6 mm <sup>2</sup>			2 x 1.5 mm <sup>2</sup> 4 x 1.0 mm <sup>2</sup>		
<b>Gauges</b>	B6			B6			A3		
<b>Approvals</b>									
<b>Wire Range</b>	20-6 AWG	20-6 AWG	10 mm <sup>2</sup>	20-6 AWG	20-6 AWG	10 mm <sup>2</sup>	22-12 AWG	22-12 AWG	2.5 mm <sup>2</sup>
<b>Voltage Rating</b>	600V	600V	750V	600V	600V	750V	600V	600V	800V
<b>Current Rating</b>	30A	30A		30A	30A		20A	20A	16A
<b>Tightening Torque</b>	Max 2.0 Nm			Max 2.0 Nm			Max 0.5 Nm		
<b>Lever</b>	Plastic material resistant up to 250° C			Plastic material resistant up to 250° C					
<b>Internal Bus</b>	Silver-plated brass			Silver-plated brass			Tin-plated brass		
<b>Fuse Terminal</b>	Silver-plated bronze			Silver-plated bronze			<b>Disconnecter Blade:</b> Tin-plated copper alloy		
<b>ACCESSORIES</b>	<b>Cat. No.</b>			<b>Cat. No.</b>			<b>Cat. No.</b>		
<b>Available Colors</b>	6110010 – Gray			6110110 – 12-24V 6110120 – 60V 6110130 – 110V 6110140 – 220V			6102050 – Gray		
<b>End Bracket Qty. pk. 50</b>	6804150 – 58 mm (L) x 36 mm (H) x 9 mm (W)			6804150 – 58 mm (L) x 36 mm (H) x 9 mm (W)			6804150 – 58 mm (L) x 36 mm (H) x 9 mm (W)		





## DIN Ground

- **Plastic Body:** Polyamide 6.6
- **Clamp:** Hardened steel, electro-plated with zinc yellow chromated
- **Foot:** Steel, zinc plated and yellow chromated
- **Screws:** Steel, zinc plated and yellow chromated
- **Tracking Resistance:**  
IEC 112: CTI > 600  
VDE 0303: KB > 600

**6104300**  
**4/7**





**6104310**  
**6/8**

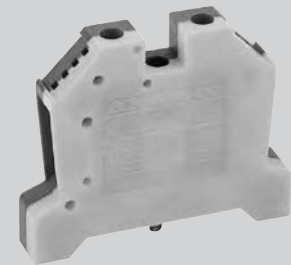

**6104320**  
**10/10**



<b>Dimensions</b>	58 mm (L) x 36 mm (H) x 7 mm (W)			58 mm (L) x 44 mm (H) x 8 mm (W)			58 mm (L) x 44 mm (H) x 10 mm (W)		
<b>Opening</b>	4 x 3.3 mm			5 x 4 mm			4 x 3.3 mm		
<b>Stripping Length</b>	10 mm			12 mm			13 mm		
<b>Screw Thread</b>	M 3			M 3.5			M 4		
<b>Ground Screw</b>	M 3			M 3			M 3		
<b>Metal Part</b>	Tin-plated copper			Brass			Tin-plated brass		
<b>Connecting Capacity</b>	Solid conductors mm <sup>2</sup> 0.5-4 Stranded conductors mm <sup>2</sup> 0.5-4			Solid conductors mm <sup>2</sup> 0.5-6 Stranded conductors mm <sup>2</sup> 0.5-2.6			Solid conductors mm <sup>2</sup> 1.5-10 Stranded conductors mm <sup>2</sup> 1.5-10		
<b>Conductors with Ferrules</b>	DIN 46288 / 1 mm <sup>2</sup> 0.5-4			DIN 46288 / 1 mm <sup>2</sup> 0.5-6			DIN 46288 / 1 mm <sup>2</sup> 1.5-10		
<b>Number of Connectable Conductors</b>	4 x 1.5 mm <sup>2</sup>			2 x 4 mm <sup>2</sup>			2 x 6 mm <sup>2</sup>		
<b>Gauges</b>	A4			B6			B6		
<b>Approvals</b>									
<b>Wire Range</b>	24-10 AWG	24-10 AWG	4 mm <sup>2</sup>	22-8 AWG	22-8 AWG	6 mm <sup>2</sup>	18-6 AWG	20-8 AWG	10 mm <sup>2</sup>
<b>Voltage Rating</b>									
<b>Current Rating</b>									
<b>Tightening Torque</b>	Max 0.6 Nm			Max 1.2 Nm			Max 2.0 Nm		
<b>ACCESSORIES</b>	<b>Cat. No.</b>			<b>Cat. No.</b>			<b>Cat. No.</b>		
<b>End Bracket</b> Qty. pk. 50	<b>6804150</b> – 58 mm (L) x 36 mm (H) x 9 mm (W)			<b>6804150</b> – 58 mm (L) x 36 mm (H) x 9 mm (W)			<b>6804150</b> – 58 mm (L) x 36 mm (H) x 9 mm (W)		



## DIN Ground

- **Plastic Body:** Polyamide 6.6
- **Clamp:** Hardened steel, electroplated with zinc yellow chromated
- **Foot:** Steel, zinc plated and yellow chromated
- **Screws:** Steel, zinc plated and yellow chromated
- **Tracking Resistance:**  
IEC 112: CTI > 600  
VDE 0303: KB > 600

**6104330**  
**16-25/12**





**6104340**  
**35-50/16**



**6504010**  
**4/6 Mini**



<b>Dimensions</b>	58 mm (L) x 49 mm (H) x 12 mm (W)	62 mm (L) x 60 mm (H) x 16 mm (W)	32 mm (L) x 28 mm (H) x 6 mm (W)
<b>Opening</b>	7 x 7.4 mm	11 x 10 mm	4 x 3.3 mm
<b>Stripping Length</b>	14 mm	18 mm	10 mm
<b>Screw Thread</b>	M 5	M 6	M 3
<b>Ground Screw</b>	M 3	M 4 Nickel-plated brass	
<b>Metal Part</b>	Brass	Tin-plated brass	Tin-plated Copper
<b>Connecting Capacity</b>	Solid conductors mm <sup>2</sup> 1.5-25 Stranded conductors mm <sup>2</sup> 1.5-26	Solid conductors mm <sup>2</sup> 2.5-50 Stranded conductors mm <sup>2</sup> 2.5-35	Solid conductors mm <sup>2</sup> 0.5-4 Stranded conductors mm <sup>2</sup> 0.5-4
<b>Conductors with Ferrules</b>	DIN 46288 / 1 mm <sup>2</sup> 1.5-16	DIN 46288 / 1 mm <sup>2</sup> 2.5-35	DIN 46288 / 1 mm <sup>2</sup> 1.5-4
<b>Number of Connectable Conductors</b>	2 x 10 mm <sup>2</sup>	2 x 25 mm <sup>2</sup>	4 x 1.5 mm <sup>2</sup>
<b>Gauges</b>	B7	B9	A4
<b>Approvals</b>			
<b>Wire Range</b>	14-4 AWG   14-4 AWG   25 mm <sup>2</sup>	14-1/0 AWG   14-2/0 AWG   35 mm <sup>2</sup>	18-10 AWG   18-10 AWG   2.5 mm <sup>2</sup>
<b>Voltage Rating</b>			
<b>Current Rating</b>			
<b>Tightening Torque</b>	Max 3.0 Nm	Max 5.0 Nm	Max 0.6 Nm
<b>ACCESSORIES</b>	<b>Cat. No.</b>	<b>Cat. No.</b>	<b>Cat. No.</b>
<b>End Bracket</b> Qty. pk. 50	<b>6804150</b> – 58 mm (L) x 36 mm (H) x 9 mm (W)	<b>6804150</b> – 58 mm (L) x 36 mm (H) x 9 mm (W)	<b>6804500</b> – 58 mm (L) x 36 mm (H) x 9 mm (W)



*Screw Connection*  
**Mounting Rails**  
**35x7.5**

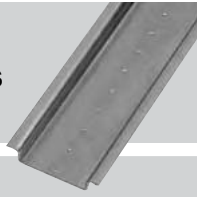

*Screw Connection*  
**Mounting Rails**  
**35x7.5 Slotted**

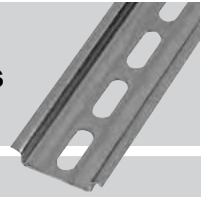

<b>Part Number</b>	6804100
<b>Materials</b>	Steel zinc-plated and yellow-cromated
<b>Weight</b>	0,35 kg/m
<b>Aluminum</b>	Al Mg Si 0.5
<b>Copper</b>	Electrolytic
<b>Standard length of bars</b>	2 m
<b>Quantity pack</b>	40 m bundles
<b>Weight Pack</b>	14 Kg
<b>Terminal blocks up to</b>	16-35-50 mm <sup>2</sup>

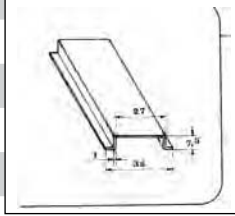

<b>Part Number</b>	6804101
<b>Materials</b>	Steel zinc-plated and yellow-cromated
<b>Weight</b>	0,31 kg/m
<b>Aluminum</b>	Al Mg Si 0.5
<b>Copper</b>	Electrolytic
<b>Standard length of bars</b>	2 m
<b>Quantity pack</b>	40 m bundles
<b>Weight Pack</b>	12.5 Kg
<b>Terminal blocks up to</b>	16-35-50 mm <sup>2</sup>

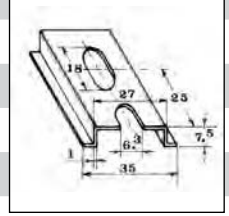

*Screw Connection*  
**Mounting Rails**  
**35x15**

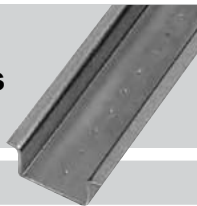

*Screw Connection*  
**Mounting Rails**  
**35x15 Slotted**

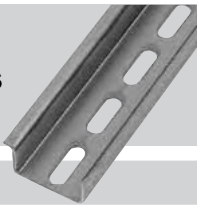

*Screw Connection*  
**Mounting Rails**  
**15x5.5 Slotted**



<b>Part Number</b>	6804110
<b>Materials</b>	Steel zinc-plated and yellow-cromated
<b>Weight</b>	0.63 kg/m
<b>Aluminum</b>	Al Mg Si 0.5
<b>Copper</b>	Electrolytic
<b>Standard length of bars</b>	2 m
<b>Quantity pack</b>	20 m bundles
<b>Weight Pack</b>	25 Kg
<b>Terminal blocks up to</b>	0-95-150 mm <sup>2</sup>

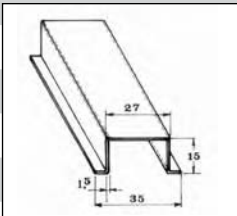

<b>Part Number</b>	6804111
<b>Materials</b>	Steel zinc-plated and yellow-cromated
<b>Weight</b>	0.63 kg/m
<b>Aluminum</b>	Al Mg Si 0.5
<b>Copper</b>	Electrolytic
<b>Standard length of bars</b>	2 m
<b>Quantity pack</b>	20 m bundles
<b>Weight Pack</b>	24 Kg
<b>Terminal blocks up to</b>	50-95-150 mm <sup>2</sup>

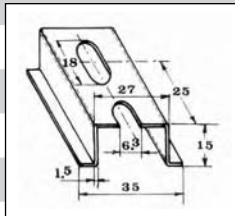

<b>Part Number</b>	6804505
<b>Materials</b>	Steel zinc-plated and yellow-cromated
<b>Weight</b>	0.15 kg/m
<b>Aluminum</b>	Al Mg Si 0.5
<b>Copper</b>	Electrolytic
<b>Standard length of bars</b>	2 m
<b>Quantity pack</b>	20 m bundles
<b>Weight Pack</b>	3 Kg
<b>Terminal blocks up to</b>	10-16-25 mm <sup>2</sup>

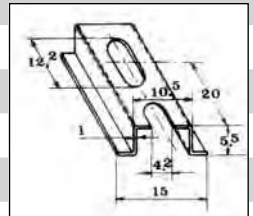

*Screw Connection*  
**Angled Support**  
**Bracket**

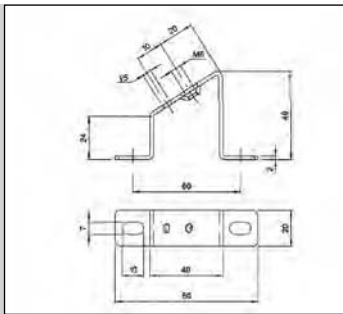

<b>Part Number</b>	6804160
<b>Materials</b>	Steel zinc-plated and yellow cromated
<b>Dimensions</b>	78 mm (L) x 48 mm (H) x 20 mm (W)
<b>Oval Fixing</b>	6.9 x 9.8 mm
<b>Quantity pack</b>	50 pieces



# Slotted Screwdrivers (Tip Size)

Part Number	Description	2.5mm	3.0mm	3.5mm	4mm	5mm	other
<b>6104000</b>	Din 4			•			
<b>6106000</b>	Din 6				•		
<b>6110000</b>	Din 10				•		
<b>6116000</b>	Din 16–25					•	
<b>6135000</b>	Din 35–50					•	
<b>6170000</b>	Din 70						hex
<b>6102000</b>	Din 2.5		•				
<b>6504000</b>	Mini			•			
<b>6102050</b>	Knife Disc		•				
<b>6104310</b>	Din 6G				•		
<b>6104330</b>	Din 16–25G					•	
<b>6104300</b>	Din 4G			•			
<b>6104340</b>	Din 35–50G					•	
<b>6104320</b>	Din 10G				•		
<b>6504010</b>	Mini Gnd			•			
<b>6204000</b>	Double			•			
<b>6204010</b>	x-conn			•			
<b>6204200</b>	Diode			•			
<b>6204110</b>	LED 12–24			•			
<b>6204130</b>	LED 110			•			
<b>6302000</b>	Triple	•					
<b>6302100</b>	Sensor	•					
<b>6110010</b>	Fuse 1/4x1-1/4				•		
<b>6104500</b>	Fuse 5x20		•				
<b>6104600</b>	Disc Bar				•		
<b>6104110</b>	Fuse 5x20 led		•				
<b>6104120</b>	Fuse 5x20 led		•				
<b>6104130</b>	Fuse 5x20 led		•				
<b>6104140</b>	Fuse 5x20 led		•				
<b>6110110</b>	Fuse 1/4x1-1/4 led				•		
<b>6110120</b>	Fuse 1/4x1-1/4 led				•		
<b>6110130</b>	Fuse 1/4x1-1/4 led				•		
<b>6110230</b>	Fuse 1/4x1-1/4 led				•		
<b>6302110</b>	Sensor pnp	•					
<b>6302120</b>	Sensor npn	•					

## Marking Strips

### Series 6806100

For terminal blocks: DIN 4, DIN 4-2, DIN Fuse Blocks, DIN G Ground

6806100	white
6806101	1-50
6806102	51-100
6806103	101-150
6806104	151-200
6806150	L1-L2-L3, L, N, $\underline{\underline{=}}$ , +, -, COM, COM

### Series 6806000

For terminal blocks: DIN 2.5, DIN T

6806000	white
6806001	1-100
6806002	101-200
6806050	L1-L2-L3, L, N, $\underline{\underline{=}}$ , +, -, COM, COM

### Series 6806600

For terminal blocks: DIN 4/15, DIN 2.5, DIN 2.5, DIN 4x2 (two stage); DIN Fuse Block; DIN Ground

6806600	white
6806601	1-5
6806602	6-10
6806650	0-9, +, -, ~, =, $\underline{\underline{=}}$ , A-Z



# Custom Terminal Blocks *We Build Confidence!*

Curtis will design and manufacture custom terminal blocks when a standard block does not meet the requirements. Contact your local Curtis Representative or Curtis directly with your requirements.



***Curtis Industries***  
A Division of Powers Holdings, Inc.





RFI Filters



Filtered Power Entry



Custom Filters



DIN Rail

# *Curtis* Family of Products



Terminal Blocks



PCB Mount Blocks

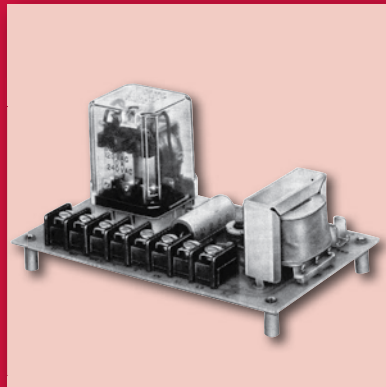

Liquid Level  
Controllers



Custom Terminal Blocks



## *Curtis Industries*

A Div. of Powers Holdings, Inc.

2400 S. 43rd St., Milwaukee, WI 53219

1-800-657-0853

[www.curtisind.com](http://www.curtisind.com)