

Data Sheet



Description

This 3W power LED light source is a high-performance, energy-efficient device that can handle high thermal and high driving current. The exposed pad design enables excellent heat transfer from the package to the motherboard. An option with electrically isolated metal slug is also available.

The white power LED is available in the range of color temperature from 2700K to 10000K.

The low profile package design is suitable for a wide variety of applications especially where height is a constraint.

The package is compatible with reflow soldering process. This part has a footprint that is compatible to most of the high power LEDs in the market today.

Features

- Available in red, red orange, amber, green, blue, royal blue, cool white, neutral white, and warm white colors
- Energy efficient
- Exposed metal slug for excellent heat transfer
- Compatible with reflow soldering process
- High current operation
- Long operation life
- Wide viewing angle at 140°
- Silicone encapsulation
- Non-ESD sensitive (threshold > 16 kV)
- MSL 2a products

Applications

- Architectural lighting
- Channel backlighting
- Contour lighting
- Retail display lighting
- Decorative lighting
- Garden lighting
- Safety, exit, and emergency signs lighting
- Specialty lighting
- Task lighting

Figure 1 ASMT-Ax3x Package Outline Drawing

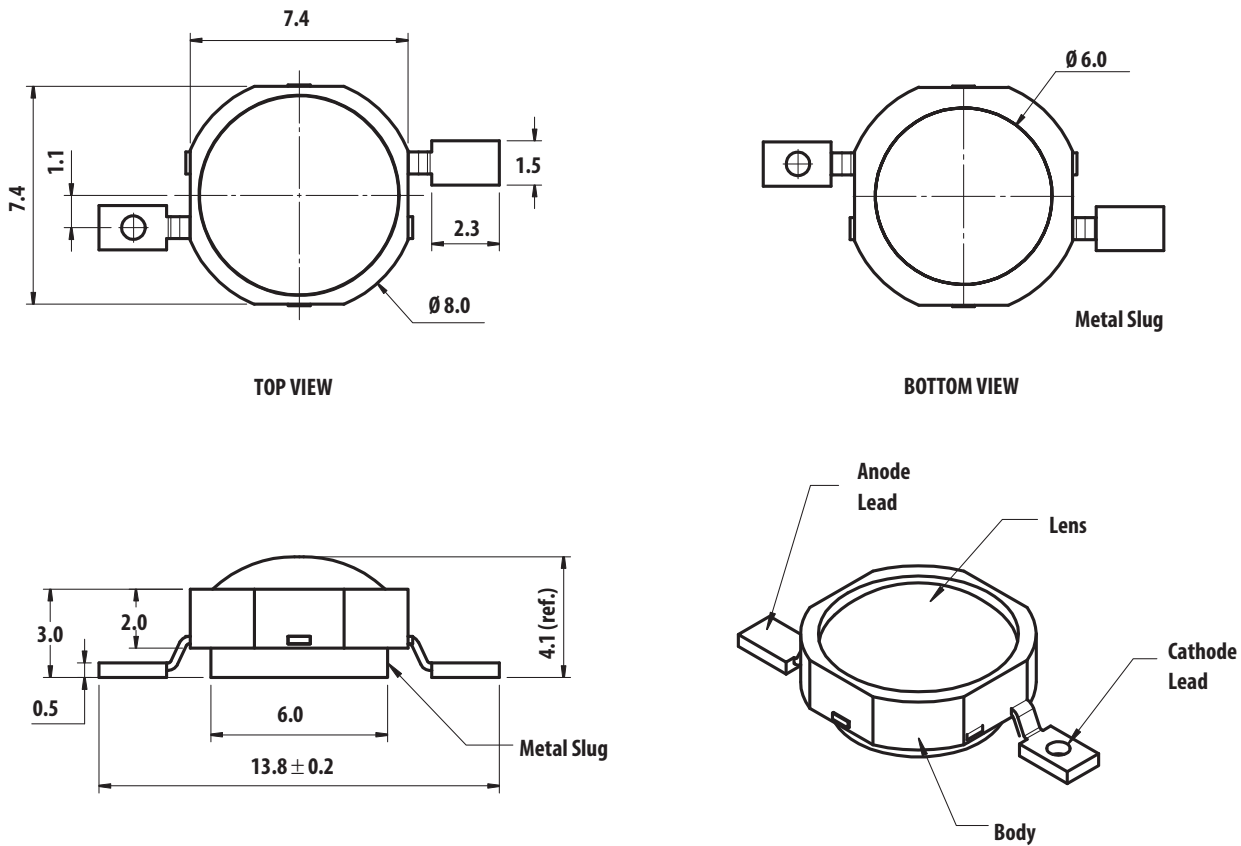
**NOTE**

1. All dimensions in millimeters.
2. Metal slug is connected to anode for electrically non-isolated option.
3. Tolerance is ± 0.1 mm unless otherwise specified.
4. Terminal finish: Ag plating.

Device Selection Guide ($T_J = 25^\circ\text{C}$)

Part Number	Color	Luminous Flux (lm) / Radiometric Power (mW), Φ_V ^{a, b}			Test Current (mA)	Dice Technology	Electrically Isolated Metal Slug
		Min.	Typ.	Max.			
ASMT-AR30-AST00	Red	51.7	60.0	87.4	350	AllnGaP	No ^c
ASMT-AH30-ARS00	Red Orange	39.8	50.0	67.2	350	AllnGaP	No ^c
ASMT-AA30-ARS00	Amber	39.8	50.0	67.2	350	AllnGaP	No ^c
ASMT-AG31-NTU00	Green	67.2	78.0	99.6	350	InGaN	Yes
ASMT-AG31-NUV00		87.4	105.0	113.6	350	InGaN	Yes
ASMT-AB31-NMP00	Blue	13.9	18.0	30.6	350	InGaN	Yes
ASMT-AB31-NNP00		18.1	23.0	30.6	350	InGaN	Yes
ASMT-AL31-NRS00	Royal Blue	515 mW	600 mW	685 mW	350	InGaN	Yes
ASMT-AW31-NVX00	Cool White	99.6	120.0	147.7	350	InGaN	Yes
ASMT-AN31-NWX00	Neutral White	113.6	120.0	147.7	350	InGaN	Yes
ASMT-AY31-NUW00	Warm White	87.4	95.0	129.5	350	InGaN	Yes

- Φ_V is the total luminous flux/radiometric power output as measured with an integrating sphere at 25-ms mono pulse condition.
- Flux and power tolerance is $\pm 10\%$.
- Electrically isolated metal slug option is also available. Contact your Broadcom sales representative.

Absolute Maximum Ratings

Parameter	AllnGaP	InGaN	Units
DC Forward Current ^a	700	700	mA
Peak Pulsing Current	1500	2400	mA
Power Dissipation	1820	2730	mW
LED Junction Temperature	125	135	$^\circ\text{C}$
Operating Metal Slug Temperature Range at 350 mA	-40 to +115	-40 to +120	$^\circ\text{C}$
Operating Metal Slug Temperature Range at 700 mA	-40 to +100	-40 to +105	$^\circ\text{C}$
Storage Temperature Range	-40 to +120	-40 to +120	$^\circ\text{C}$
Soldering Temperature	See Figure 29		
Reverse Voltage ^b	Not recommended		

- Derate linearly based on [Figure 13](#) and [Figure 14](#) for AllnGaP and [Figure 25](#) and [Figure 26](#) for InGaN.
- Not recommended for reverse bias operation.

Optical Characteristics at 350 mA ($T_J = 25^\circ\text{C}$)

Part Number	Color	Peak Wavelength, λ_{PEAK} (nm)	Dominant Wavelength, λ_D^a (nm)	Viewing Angle, $2\theta_{1/2}^b$ (°)	Luminous Efficiency (lm/W)
		Typ.	Typ.	Typ.	Typ.
ASMT-AR30-AST00	Red	635	625	140	82
ASMT-AH30-ARS00	Red Orange	625	615	140	68
ASMT-AA30-ARS00	Amber	598	590	140	68
ASMT-AG31-NTU00	Green	519	525	140	70
ASMT-AG31-NUV00		519	525	140	94
ASMT-AB31-NMP00	Blue	454	460	140	16
ASMT-AB31-NNP00		454	460	140	21
ASMT-AL31-NRS00	Royal Blue	450	455	140	Not applicable

a. The dominant wavelength, λ_D , is derived from the CIE Chromaticity Diagram and represents the color of the device.

b. $\theta_{1/2}$ is the off-axis angle where the luminous intensity is half of the peak intensity.

Part Number	Color	Correlated Color Temperature, CCT (Kelvin)		Viewing Angle, $2\theta_{1/2}^a$ (°)	Luminous Efficiency (lm/W)
		Min.	Max.	Typ.	Typ.
ASMT-AW31-NVX00	Cool White	4500	10000	140	107
ASMT-AN31-NWX00	Neutral White	3500	4500	140	107
ASMT-AY31-NUW00	Warm White	2700	3500	140	85

a. $\theta_{1/2}$ is the off-axis angle where the luminous intensity is half of the peak intensity.

Electrical Characteristic at 350 mA ($T_J = 25^\circ\text{C}$)

Dice Type	Forward Voltage, V_F (Volts)			Thermal Resistance, $R_{\theta j-ms}$ ($^\circ\text{C}/\text{W}$) ^a
	Min.	Typ.	Max.	Typ.
AllnGaP	1.7	2.1	2.3	10
InGaN	2.8	3.2	3.5	10

a. $R_{\theta j-ms}$ is thermal resistance from LED junction to metal slug.

Optical and Electrical Characteristic at 700 mA ($T_J = 25^\circ\text{C}$)

Part Number	Color	Luminous Flux (lm)/Radiometric Power (mW), Φ_V	Forward Voltage, V_F (Volts)
		Typ.	Typ.
ASMT-AR30-AST00	Red	112.0	2.4
ASMT-AH30-ARS00	Red Orange	94.0	2.4
ASMT-AA30-ARS00	Amber	94.0	2.4
ASMT-AG31-NTU00	Green	125.0	3.6
ASMT-AG31-NUV00		168.0	3.6
ASMT-AB31-NMP00	Blue	30.0	3.6
ASMT-AB31-NNP00		39.0	3.6
ASMT-AL31-NRS00	Royal Blue	1022 mW	3.6
ASMT-AW31-NVX00	Cool White	205.0	3.6
ASMT-AN31-NWX00	Neutral White	205.0	3.6
ASMT-AY31-NUW00	Warm White	162.0	3.6

Part Numbering System

A S M T - A x₁ 3 x₂ - x₃ x₄ x₅ x₆

Code	Description	Option	
x ₁	Color	R	Red
		H	Red-Orange
		A	Amber
		G	Green
		B	Blue
		L	Royal Blue
		W	Cool White
		N	Neutral White
		Y	Warm White
x ₂	Heat sink	0	Electrically Non Isolated
		1	Electrically Isolated
x ₃	Dice Type	N	InGaN
		A	AlInGaP
x ₄	Minimum Flux Bin	See Device Selection Guide	
x ₅	Maximum Flux Bin		
x ₆	Color Bin Selection	See Color Bin Selection Table	
x ₇	Packaging Option	0	Tube
		1	Tape and Reel

Bin Information

Flux/Power Bin Limit (x_4 , x_5)

Color	Bin ID	Luminous Flux (lm)/Radiometric Power (mW) at 350 mA	
		Min.	Max.
Blue	M	13.9	18.1
	N	18.1	23.5
	P	23.5	30.6
Other Colors	R	39.8	51.7
	S	51.7	67.2
	T	67.2	87.4
	U	87.4	99.6
	V	99.6	113.6
	W	113.6	129.5
	X	129.5	147.7
Royal Blue	P	355.0	435.0
	Q	435.0	515.0
	R	515.0	595.0
	S	595.0	685.0

Tolerance for each bin limit is $\pm 10\%$.

Color Bin Selection (x₆)

Individual reel or tube will contain parts from one color bin selection only.

Cool White

Selection	Bin ID
0	Full Distribution
B	VN and V0
E	VM, UM, VN, and UN
F	WM, VM, WN, and VN
G	XM, WM, XN, and WN
H	UN, VN, U0, and V0
J	WN, VN, W0, and V0
K	XN, WN, X0, and W0
L	V0, U0, VP, and UP
M	W0, V0, WP, VP, and WQ
N	X0, W0, XP, WP, and WQ
P	Y0
Q	YA

Warm White

Selection	Bin ID
0	Full Distribution
A	M0 and MA
B	PA and P0
C	N1 and N0
E	NM, MM, N1, and M1
F	PM, NM, P1, and N1
G	QM, PM, Q1, and P1
H	M1, N1, M0, and N0
J	P1, N1, P0, and N0
K	Q1, P1, Q0, and P0
L	N0, M0, NA, and MA
M	P0, N0, PA, and NA
N	Q0, P0, QA, and PA

Neutral White

Selection	Bin ID
0	Full Distribution
A	S1 and S0
B	S0 and R0
E	SM, RM, S1, and R1
F	TM, SM, TN, and S1
G	S1, R1, S0, and R0
H	TN, S1, T0, and S0
J	S0, R0, SA, and RA
K	T0, S0, TP, and SA

Other Colors

Selection	Bin ID
0	Full Distribution
Z	A and B
Y	B and C
W	C and D
V	D and E
Q	A, B, and C
P	B, C, and D
N	C, D, and E
M	D, E, and F

Figure 2 Color Bin Structure for Cool White

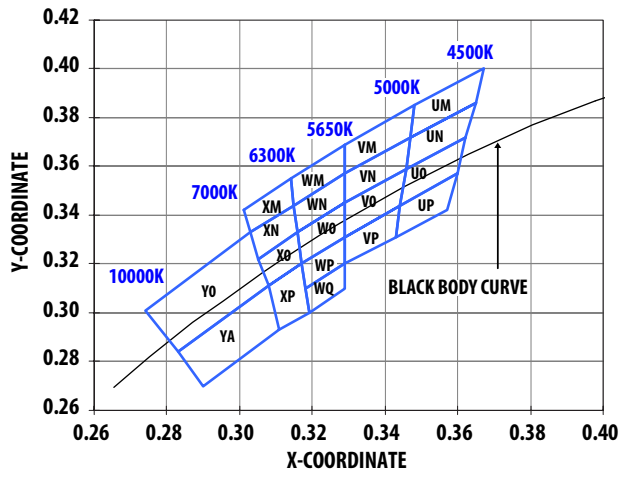

Figure 3 Color Bin Structure for Warm White

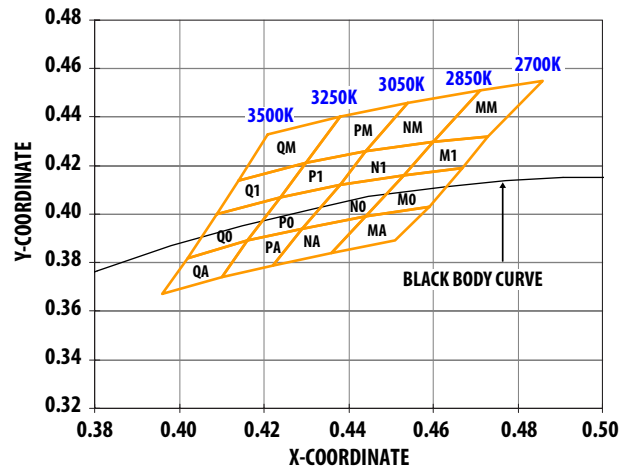
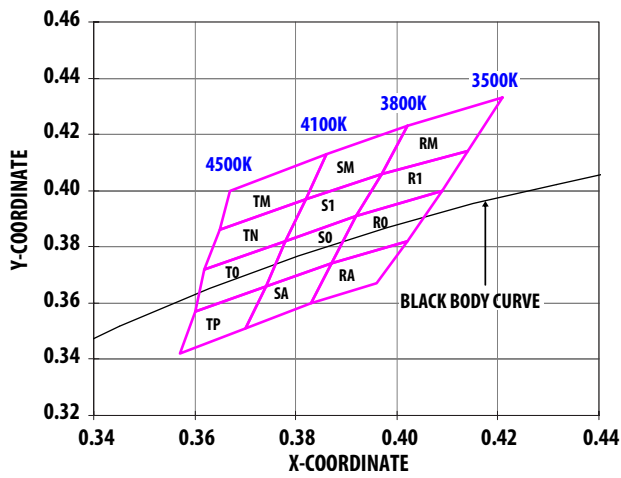

Figure 4 Color Bin Structure for Neutral White



Color Bin Limits

Cool White	Color Limits (Chromaticity Coordinates)				
Bin UM	x	0.365	0.367	0.348	0.347
	y	0.386	0.400	0.385	0.372
Bin UN	x	0.365	0.362	0.346	0.347
	y	0.386	0.372	0.359	0.372
Bin UO	x	0.362	0.360	0.344	0.346
	y	0.372	0.357	0.344	0.359
Bin UP	x	0.360	0.357	0.343	0.344
	y	0.357	0.342	0.311	0.344
Bin VM	x	0.329	0.329	0.348	0.347
	y	0.357	0.369	0.385	0.372
Bin VN	x	0.329	0.329	0.347	0.346
	y	0.345	0.357	0.372	0.359
Bin VO	x	0.329	0.329	0.346	0.344
	y	0.311	0.345	0.359	0.344
Bin VP	x	0.329	0.344	0.343	0.329
	y	0.331	0.344	0.331	0.320
Bin WM	x	0.329	0.329	0.315	0.314
	y	0.369	0.357	0.344	0.355
Bin WN	x	0.329	0.316	0.315	0.329
	y	0.345	0.333	0.344	0.357
Bin WO	x	0.329	0.329	0.317	0.316
	y	0.345	0.331	0.320	0.333
Bin WP	x	0.329	0.329	0.318	0.317
	y	0.331	0.320	0.310	0.320
Bin WQ	x	0.329	0.329	0.319	0.318
	y	0.320	0.310	0.300	0.310
Bin XM	x	0.301	0.314	0.315	0.303
	y	0.342	0.355	0.344	0.333
Bin XN	x	0.305	0.303	0.315	0.316
	y	0.322	0.333	0.344	0.333
Bin XO	x	0.308	0.305	0.316	0.317
	y	0.311	0.322	0.333	0.320
Bin XP	x	0.308	0.317	0.319	0.311
	y	0.311	0.320	0.300	0.293
Bin YO	x	0.308	0.283	0.274	0.303
	y	0.311	0.284	0.301	0.333
Bin YA	x	0.308	0.311	0.290	0.283
	y	0.311	0.293	0.270	0.284

Tolerance: ± 0.01

Warm White	Color Limits (Chromaticity Coordinates)				
Bin MM	x	0.471	0.460	0.473	0.486
	y	0.451	0.430	0.432	0.455
Bin M1	x	0.460	0.453	0.467	0.473
	y	0.430	0.416	0.419	0.432
Bin M0	x	0.453	0.444	0.459	0.467
	y	0.416	0.399	0.403	0.419
Bin MA	x	0.459	0.444	0.436	0.451
	y	0.403	0.399	0.384	0.389
Bin NM	x	0.454	0.444	0.460	0.471
	y	0.446	0.426	0.430	0.451
Bin N1	x	0.444	0.438	0.453	0.460
	y	0.426	0.412	0.416	0.430
Bin N0	x	0.438	0.429	0.444	0.453
	y	0.412	0.394	0.399	0.416
Bin NA	x	0.444	0.429	0.422	0.436
	y	0.399	0.394	0.379	0.384
Bin PM	x	0.438	0.430	0.444	0.454
	y	0.440	0.421	0.426	0.446
Bin P1	x	0.430	0.424	0.438	0.444
	y	0.421	0.407	0.412	0.426
Bin P0	x	0.424	0.416	0.429	0.438
	y	0.407	0.389	0.394	0.412
Bin PA	x	0.429	0.416	0.410	0.422
	y	0.394	0.389	0.374	0.379
Bin QM	x	0.421	0.414	0.430	0.438
	y	0.433	0.414	0.421	0.440
Bin Q1	x	0.414	0.409	0.424	0.430
	y	0.414	0.400	0.407	0.421
Bin Q0	x	0.409	0.402	0.416	0.424
	y	0.400	0.382	0.389	0.407
Bin QA	x	0.416	0.402	0.396	0.410
	y	0.389	0.382	0.367	0.374

Tolerance: ± 0.01

Neutral White	Color Limits (Chromaticity Coordinates)				
		x	y	z	w
Bin RM	x	0.421	0.414	0.397	0.402
	y	0.433	0.414	0.406	0.423
Bin R1	x	0.414	0.409	0.392	0.397
	y	0.414	0.400	0.391	0.406
Bin R0	x	0.392	0.387	0.402	0.409
	y	0.391	0.374	0.382	0.400
Bin RA	x	0.387	0.383	0.396	0.402
	y	0.374	0.360	0.367	0.382
Bin SM	x	0.402	0.397	0.382	0.386
	y	0.423	0.406	0.397	0.413
Bin S1	x	0.397	0.392	0.378	0.382
	y	0.406	0.391	0.382	0.397
Bin S0	x	0.392	0.387	0.374	0.378
	y	0.391	0.374	0.366	0.382
Bin SA	x	0.387	0.383	0.370	0.374
	y	0.374	0.360	0.351	0.366
Bin TM	x	0.386	0.382	0.365	0.367
	y	0.413	0.397	0.386	0.400
Bin TN	x	0.382	0.378	0.362	0.365
	y	0.397	0.382	0.372	0.386
Bin T0	x	0.378	0.374	0.360	0.362
	y	0.382	0.366	0.357	0.372
Bin TP	x	0.374	0.370	0.357	0.360
	y	0.366	0.351	0.342	0.357

Tolerance: ± 0.01

Packaging Option (x₇)

Selection	Option
0	Tube
1	Tape and Reel

Color	Bin ID	Dominant Wavelength (nm) at 350 mA	
		Min.	Max.
Red	—	620.0	635.0
Red Orange	—	610.0	620.0
Amber	B	587.0	589.5
	C	589.5	592.0
	D	592.0	594.5
	E	594.5	597.0
Green	A	515.0	520.0
	B	520.0	525.0
	C	525.0	530.0
	D	530.0	535.0
Blue	A	455.0	460.0
	B	460.0	465.0
	C	465.0	470.0
	D	470.0	475.0

Tolerance: ± 1 nm

Color	Bin ID	Peak Wavelength (nm) at 350 mA	
		Min.	Max.
Royal Blue	C	440.0	445.0
	D	445.0	450.0
	E	450.0	455.0
	F	455.0	460.0

Tolerance: ± 2 nm

Example

ASMT-AW31-NVX00

ASMT-AW31-Nxxxx – Cool White, InGaN, Electrically isolated Heat Sink

X₄ = V – Minimum Flux Bin VX₅ = X – Maximum Flux Bin XX₆ = 0 – Full DistributionX₇ = 0 – Tube Option

AllnGaP

Figure 5 Relative Intensity vs. Wavelength

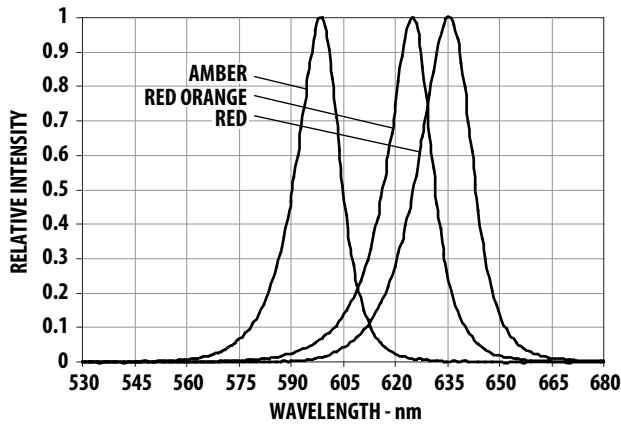

Figure 6 Relative Luminous Flux vs. Mono Pulse Current

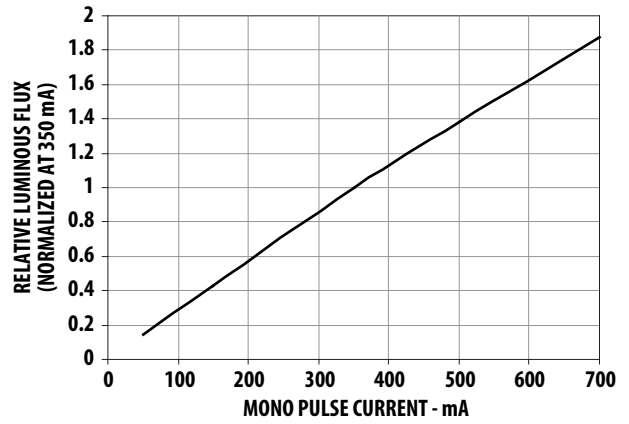

Figure 7 Forward Current vs. Forward Voltage

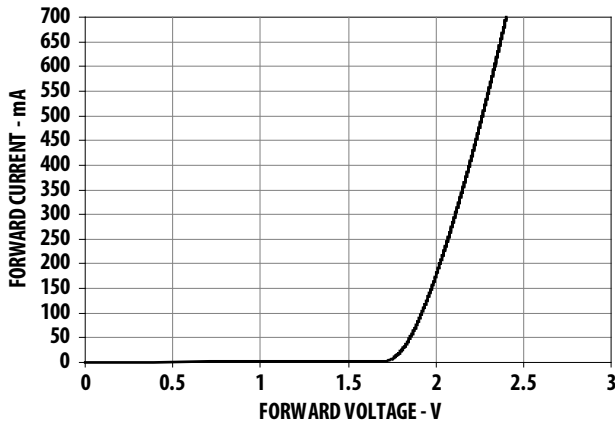

Figure 8 Radiation Pattern for Red, Red Orange, and Amber

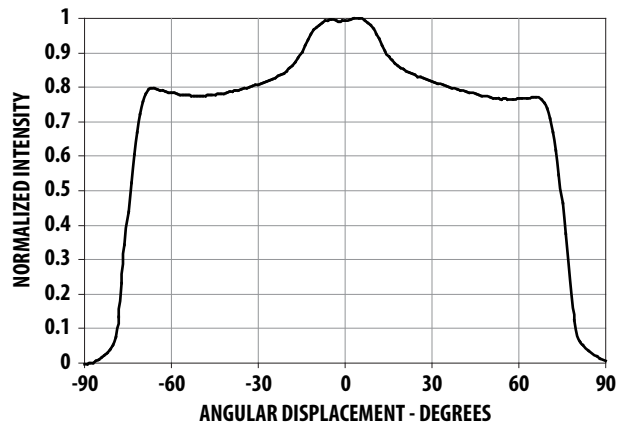

Figure 9 Maximum Pulse Current vs. Pulse Duration. Derated based on $T_A = 25^\circ\text{C}$, $R_{\theta J-A} = 30^\circ\text{C/W}$.

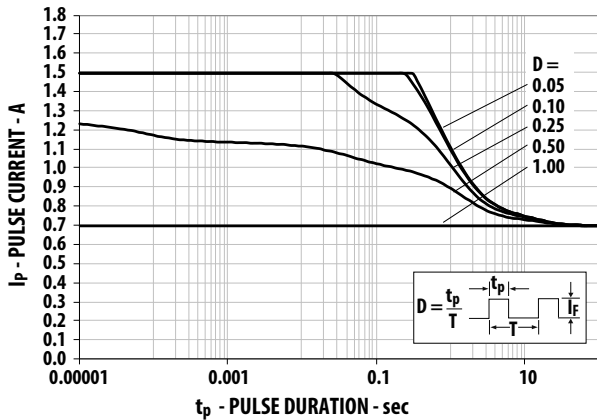
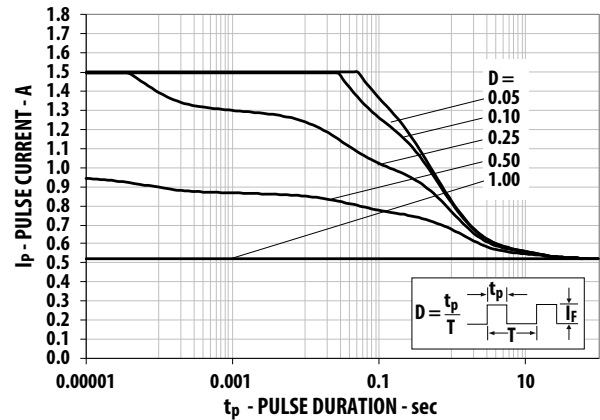

Figure 10 Maximum Pulse Current vs. Pulse Duration. Derated based on $T_A = 85^\circ\text{C}$, $R_{\theta J-A} = 30^\circ\text{C/W}$.



AllnGaP

Figure 11 Relative Light Output vs. Junction Temperature

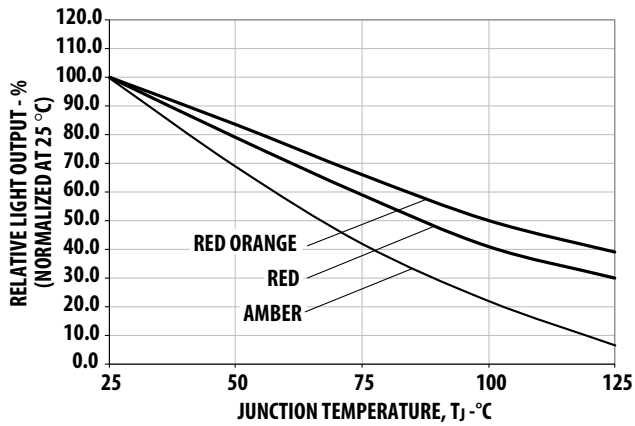

Figure 12 Forward Voltage Shift vs. Junction Temperature

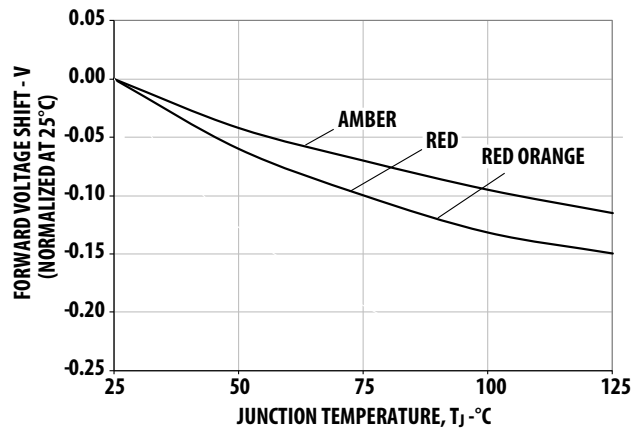

Figure 13 Maximum Forward Current vs. Ambient Temperature. Derated based on T_{JMAX} = 125°C, R_{θJ-A} = 20°C/W, 25°C/W, and 30°C/W.

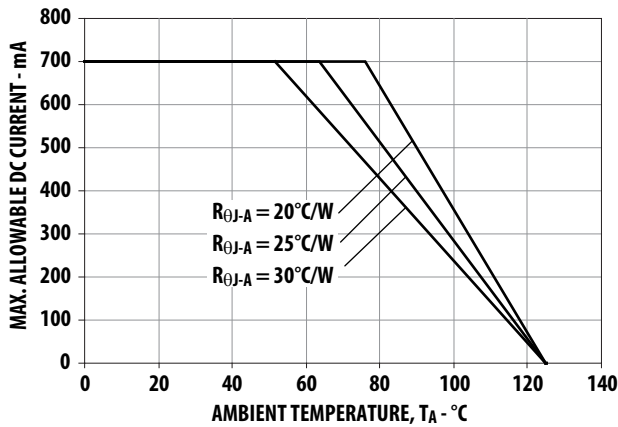
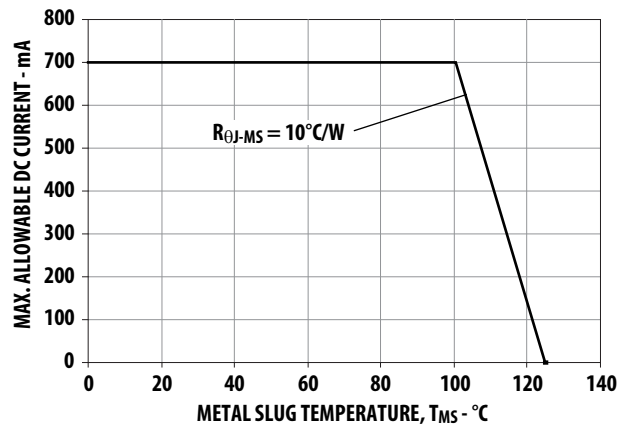

Figure 14 Maximum Forward Current vs. Metal Slug Temperature. Derated based on T_{JMAX} = 125°C, R_{θJ-MS} = 10°C/W.



InGaN

Figure 15 Relative Intensity vs. Wavelength for Warm, Neutral, and Cool White

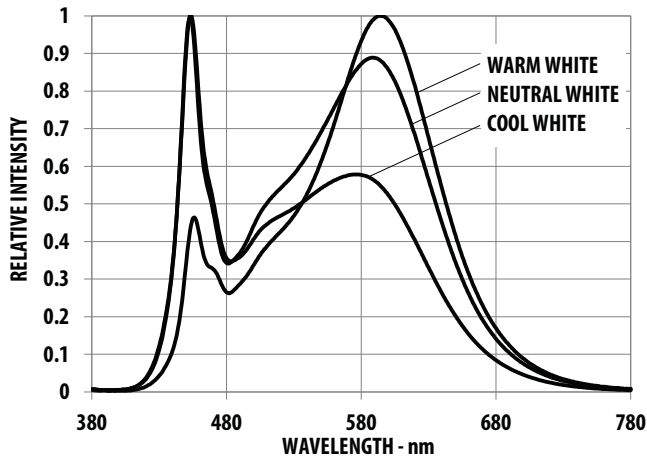

Figure 16 Relative Intensity vs. Wavelength for Blue, Royal Blue, and Green

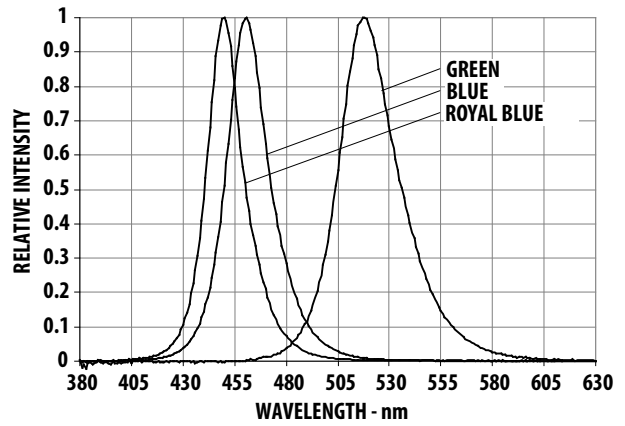

Figure 17 Relative Luminous Flux vs. Mono Pulse Current

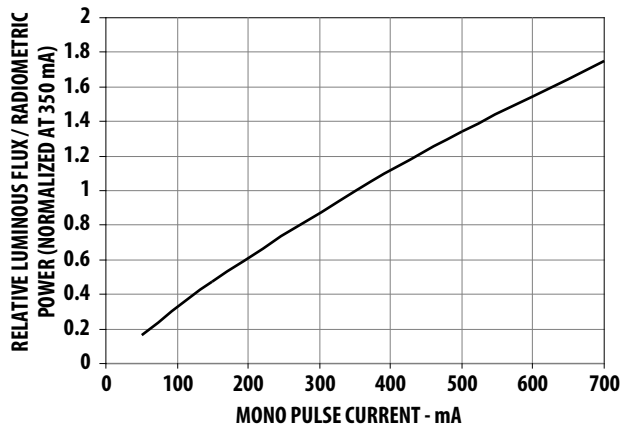

Figure 18 Forward Current vs. Forward Voltage

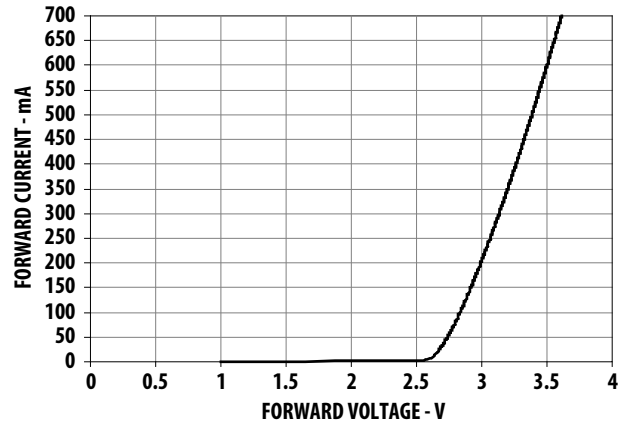

Figure 19 Radiation Pattern for Blue, Royal Blue and Green

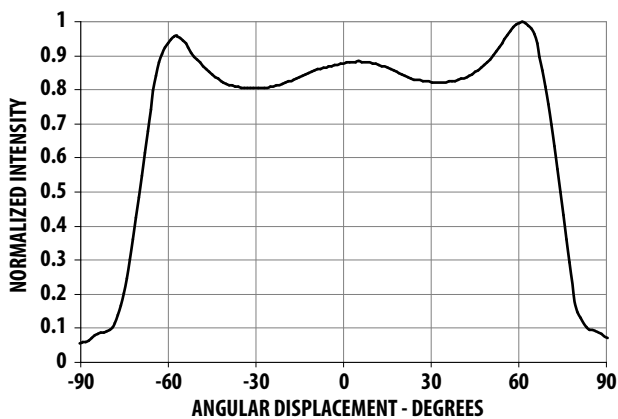
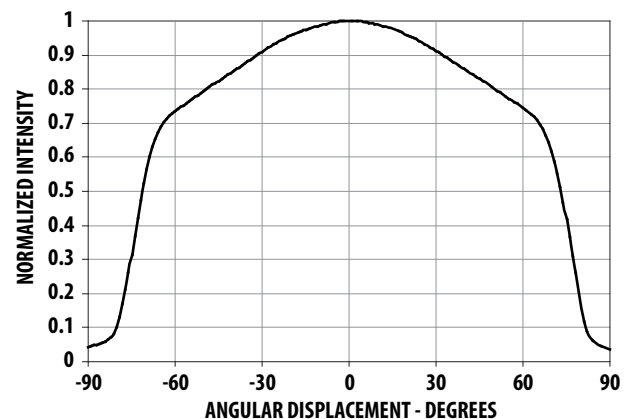

Figure 20 Radiation Pattern for Cool White, Neutral White and Warm White



InGaN

Figure 21 Maximum Pulse Current vs. Pulse Duration. Derated based on $T_A = 25^\circ\text{C}$, $R_{\theta J-A} = 30^\circ\text{C/W}$.

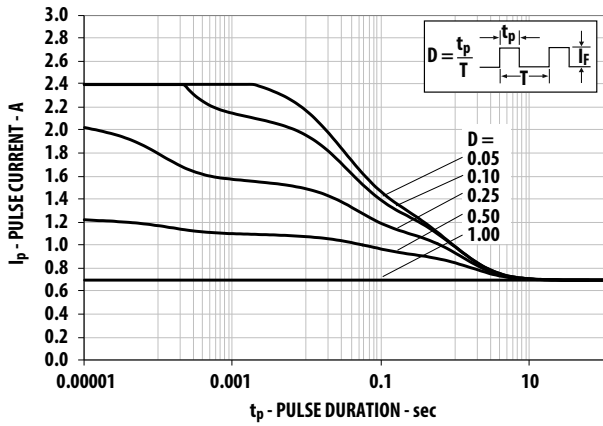

Figure 23 Relative Light Output vs. Junction Temperature

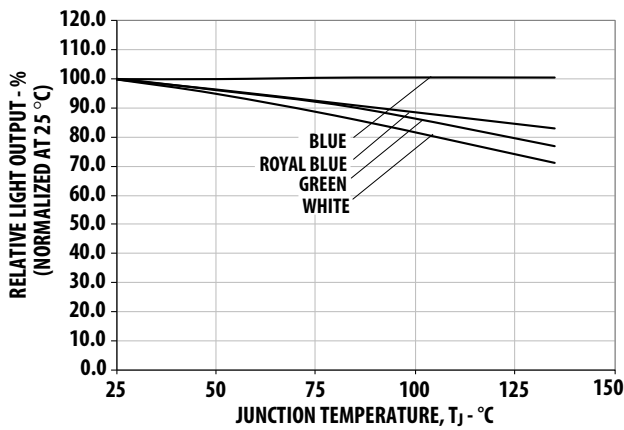

Figure 25 Maximum Forward Current vs. Ambient Temperature. Derated based on $T_{JMAX} = 135^\circ\text{C}$, $R_{\theta J-A} = 20^\circ\text{C/W}$, 25°C/W and 30°C/W .

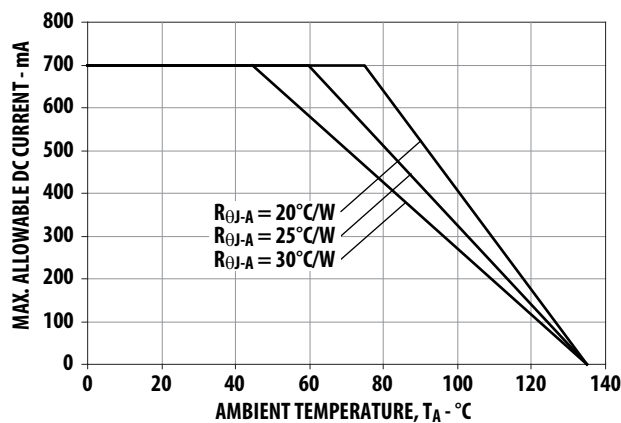

Figure 22 Maximum Pulse Current vs. Pulse Duration. Derated based on $T_A = 85^\circ\text{C}$, $R_{\theta J-A} = 30^\circ\text{C/W}$.

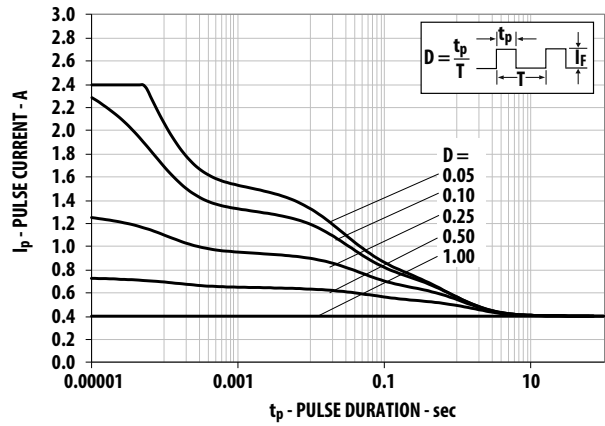

Figure 24 Forward Voltage Shift vs. Junction Temperature

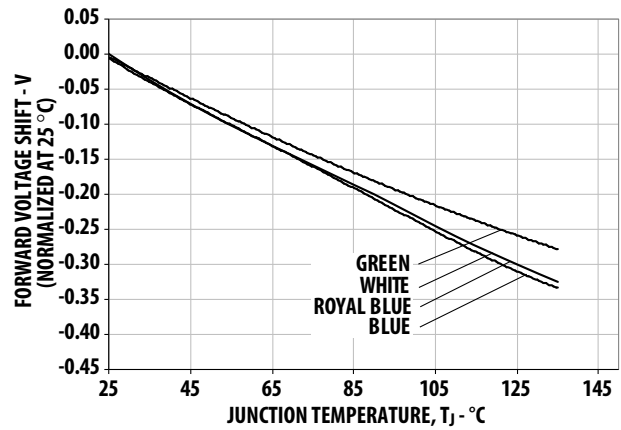

Figure 26 Maximum Forward Current vs. Metal Slug Temperature. Derated based on $T_{JMAX} = 135^\circ\text{C}$, $R_{\theta J-MS} = 10^\circ\text{C/W}$.

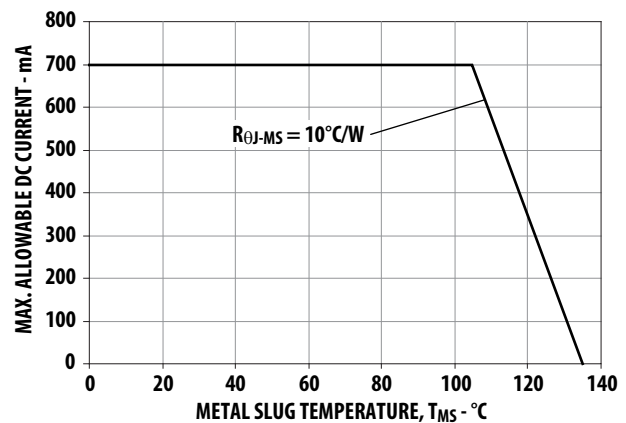

Figure 27 Recommended Soldering Land Pattern

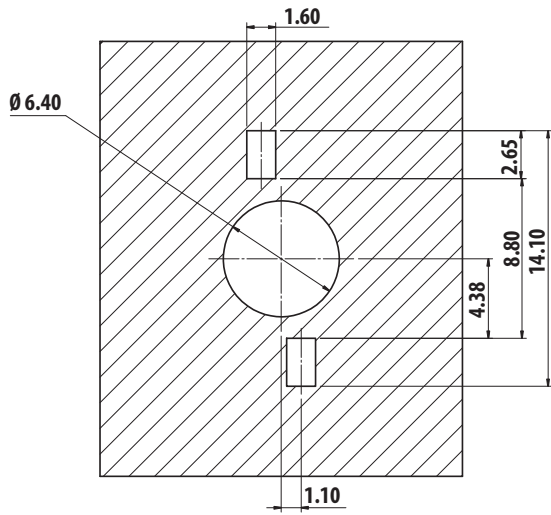

Figure 28 Recommended Pick and Place Nozzle Tip. Inner diameter = 5.8 mm.

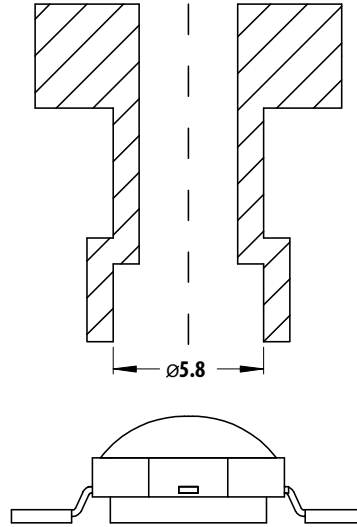
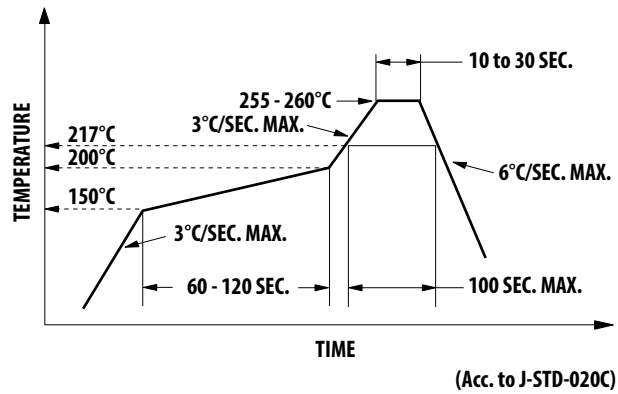

Figure 29 Recommended Soldering Profile



NOTE For detailed information on reflow soldering of Broadcom surface-mount LEDs, refer to Broadcom Application Note AN1060, *Surface Mounting SMT LED Indicator Components*.

Packing Tube – Option 0

Figure 30 Packing Tube Dimensions

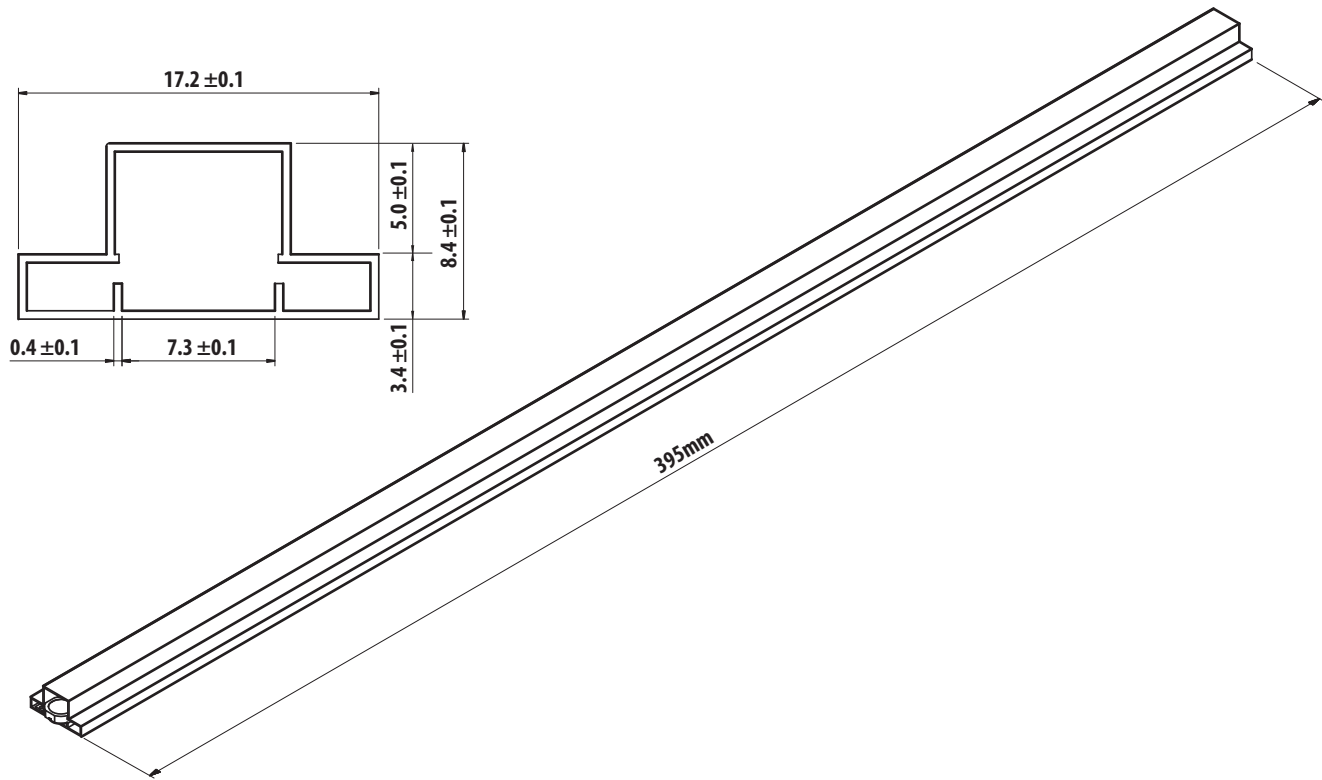

Tape and Reel – Option 1

Figure 31 Carrier Tape Dimensions

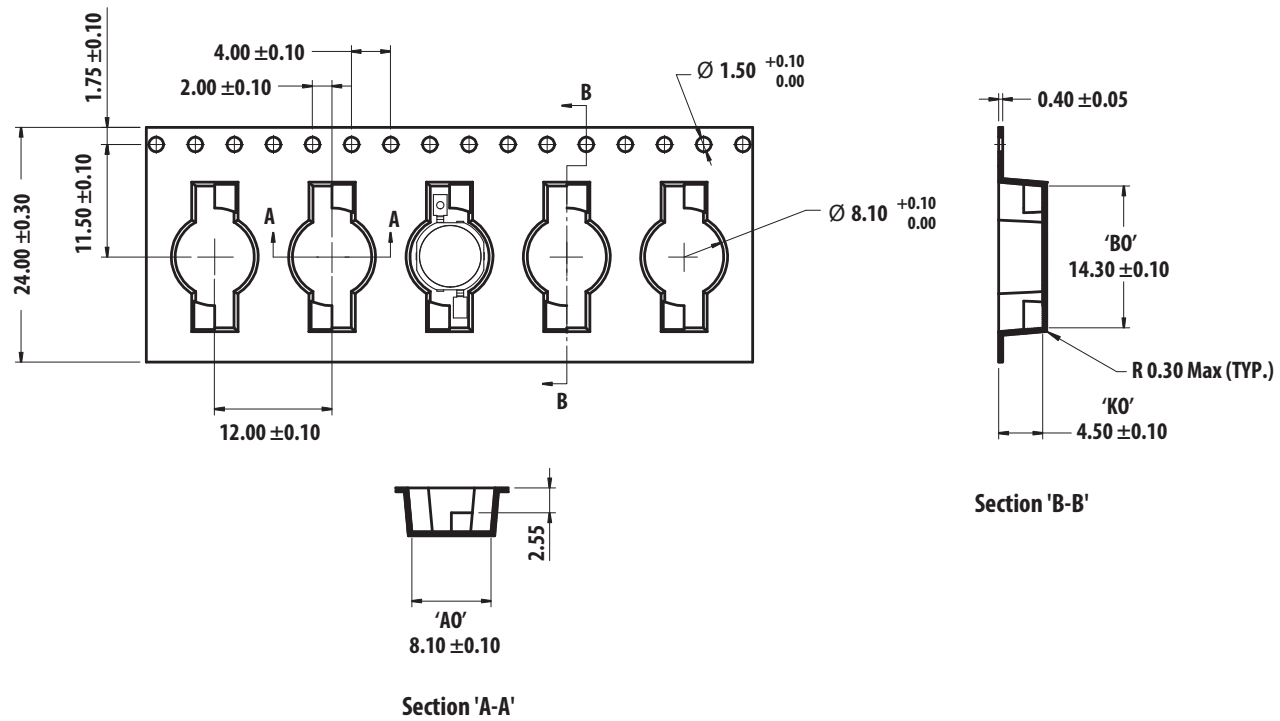
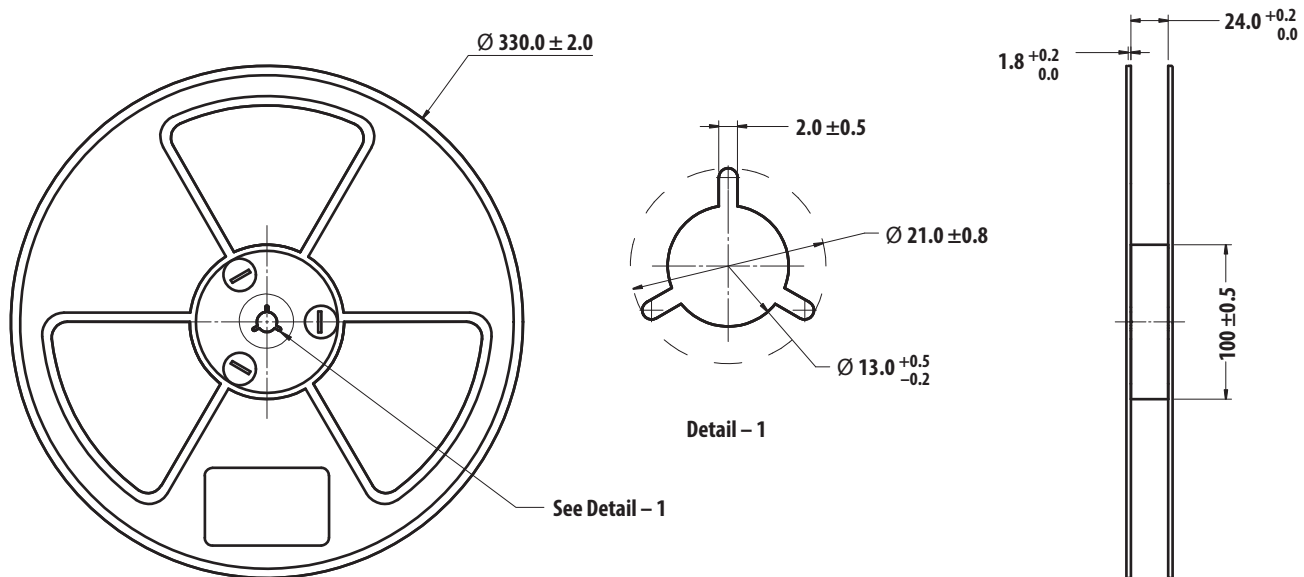

Figure 32 Reel Dimensions



NOTE All dimensions are in millimeters.

Precautionary Notes

Handling Precaution

The encapsulation material of the LED is made of silicone for better product reliability. Compared to epoxy encapsulant, which is hard and brittle, silicone is softer and flexible. Observe special handling precautions during assembly of silicone encapsulated LED products. Failure to comply might lead to damage and premature failure of the LED. Refer to Broadcom Application Note AN5288, *Silicone Encapsulation for LED: Advantages and Handling Precautions*, for additional information.

- Do not poke sharp objects into the silicone encapsulant. Sharp objects, such as tweezers or syringes, might apply excessive force or even pierce through the silicone and induce failures to the LED die or wire bond.
- Do not touch the silicone encapsulant. Uncontrolled force acting on the silicone encapsulant might result in excessive stress on the wire bond. Hold the LED only by the body.
- Do not stack assembled PCBs together. Use an appropriate rack to hold the PCBs.
- Surface of silicone material attracts dust and dirt easier than epoxy due to its surface tackiness. To remove foreign particles on the surface of silicone, use a cotton bud with isopropyl alcohol (IPA). During cleaning, rub the surface gently without putting too much pressure on the silicone. Ultrasonic cleaning is not recommended.

Moisture Sensitivity

This product has a Moisture Sensitive Level 2a rating per JEDEC J-STD-020. Refer to Broadcom Application Note AN5305, *Handling of Moisture Sensitive Surface Mount Devices*, for additional details and a review of proper handling procedures.

- Before use:
 - An unopened moisture barrier bag (MBB) can be stored at < 40°C/90% RH for 12 months. If the actual shelf life has exceeded 12 months and the humidity indicator card (HIC) indicates that baking is not required, then it is safe to reflow the LEDs per the original MSL rating.
 - Do not open the MBB prior to assembly (for example, for IQC). If unavoidable, MBB must be properly resealed with fresh desiccant and HIC. The exposed duration must be taken in as floor life.

- Control after opening the MBB:
 - Read the HIC immediately upon opening of MBB.
 - Keep the LEDs at < 30°/60% RH at all times, and complete all high temperature-related processes, including soldering, curing or rework within 672 hours.
- Control for unfinished reel:

Store unused LEDs in a sealed MBB with desiccant or a desiccator at <5% RH.
- Control of assembled boards:

If the PCB soldered with the LEDs is to be subjected to other high-temperature processes, store the PCB in a sealed MBB with desiccant or desiccator at <5% RH to ensure that all LEDs have not exceeded their floor life of 672 hours.
- Baking is required if:
 - The HIC indicator indicates a change in color for 10% and 5%, as stated on the HIC.
 - The LEDs are exposed to conditions of >30°C/60% RH at any time.
 - The LED's floor life exceeded 672 hours.

The recommended baking condition is: 60°C ± 5°C for 20 hours.

Baking can only be done once.
- Storage:

The soldering terminals of these Broadcom LEDs are silver plated. If the LEDs are exposed in ambient environment for too long, the silver plating might be oxidized, thus affecting its solderability performance. As such, keep unused LEDs in a sealed MBB with desiccant or in a desiccator at <5% RH.

DISCLAIMER: Broadcom's products and software are not specifically designed, manufactured, or authorized for sale as parts, components, or assemblies for the planning, construction, maintenance, or direct operation of a nuclear facility or for use in medical devices or applications. The customer is solely responsible, and waives all rights to make claims against Broadcom or its suppliers, for all loss, damage, expense, or liability in connection with such use.

For product information and a complete list of distributors, please go to our web site: www.broadcom.com.

Broadcom, the pulse logo, Connecting everything, Avago Technologies, Avago, and the A logo are among the trademarks of Broadcom and/or its affiliates in the United States, certain other countries and/or the EU.

Copyright © 2015–2017 by Broadcom. All Rights Reserved.

The term "Broadcom" refers to Broadcom Limited and/or its subsidiaries. For more information, please visit www.broadcom.com.

Broadcom reserves the right to make changes without further notice to any products or data herein to improve reliability, function, or design.

Information furnished by Broadcom is believed to be accurate and reliable. However, Broadcom does not assume any liability arising out of the application or use of this information, nor the application or use of any product or circuit described herein, neither does it convey any license under its patent rights nor the rights of others.

AV02-2048EN – April 24, 2017

