

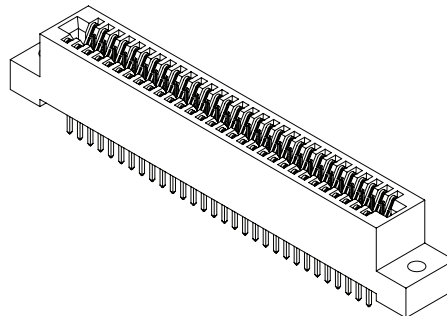

.100" [2.54 mm] Contact Centers, .610" [15.49 mm] Profile, .470" [11.94 mm] Wide Body, Dip Solder/Wire Wrap/Right Angle for .093" or .125" Mating PCB

SPECIFICATIONS

- Accommodates $.093" \pm .008"$ [2.36 mm \pm 0.20 mm] or $.125" \pm .008"$ [3.18 mm \pm 0.20 mm] mating PCB (Consult Factory for $.031" \pm .006"$ [0.79 mm \pm 0.15 mm] PC Board)
- PBT, PPS or PA9T insulator
- Molded-in key available
- 3 Amps current rating for one contact energized
- 30 milli Ohms maximum at rated current
- UL Flammability Rating: 94V-0



READOUT

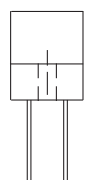

DUAL (D)

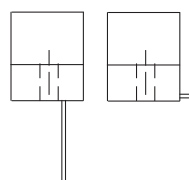

HALF LOADED (H)

TERMINATION TYPE

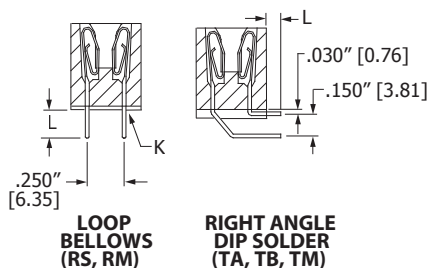

TERMINATION TYPE	POST CROSS SECTION (K)	POST LENGTH L $\pm .025$ [0.64]	FITS MIN. HOLE SIZE
RS Dip Solder	.025" [0.64] SQ.	.190" [4.83]	.040" [1.02]
RM Wire Wrap	.025" [0.64] SQ.	.560" [14.20]	.040" [1.02]
TA Right Angle	.025" [0.64] SQ.	.100" [2.54]	.043" [1.09]
TB Right Angle	.025" [0.64] SQ.	.180" [4.57]	.043" [1.09]
TM Right Angle	.025" [0.64] SQ.	.250" [6.35]	.043" [1.09]

PCB LAYOUT

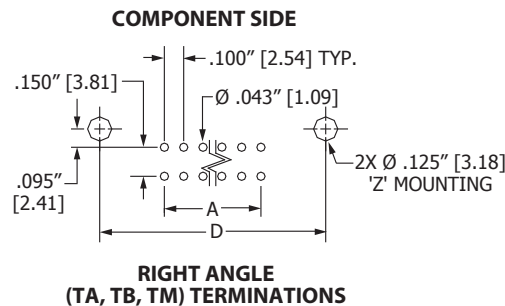
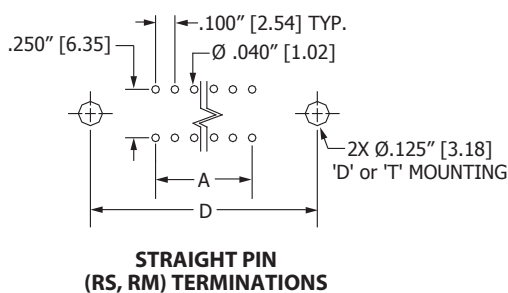

MOUNTING STYLE

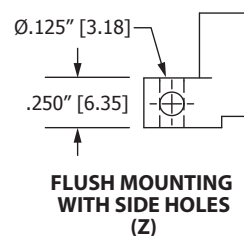
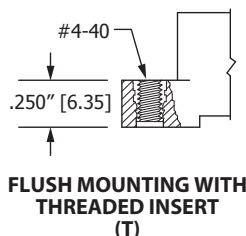
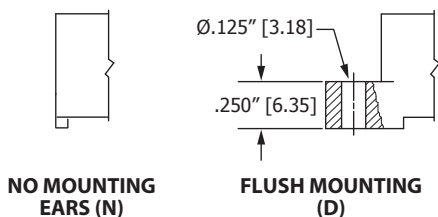



.100" [2.54 mm] Contact Centers, .610" [15.49 mm] Profile, .470" [11.94 mm] Wide Body, Dip Solder/Wire Wrap/Right Angle for .093" or .125" Mating PCB

PART NUMBER OPTIONS

MATERIALS (INSULATOR/CONTACT)

- E = PBT/Phosphor Bronze
 - R = PPS/Phosphor Bronze
 - G = PA9T/Phosphor Bronze
 - H = PBT/Beryllium Copper
 - A = PPS/Beryllium Copper
 - J = PA9T/Beryllium Copper
- (Consult factory for other materials.)
Refer to Page 7 for Operating/Processing Temperatures

CONTACT FINISH - RoHS Compliant

- All platings are Lead Free and have .000050" Nickel underplate
- | Contact Surface | Termination |
|------------------------------|--------------------------|
| B = .000010" Gold | .000100" Pure Tin, Matte |
| C = .000030" Gold | .000100" Pure Tin, Matte |
| G = .000010" Gold | .000005" Gold |
| Y = .000030" Gold | .000005" Gold |
| Contact Surface | Overall Plating |
| S = .000010" Gold | .000010" Gold |
| M = .000030" Gold | .000010" Gold |
| E = .000100" Pure Tin, Matte | .000100" Pure Tin, Matte |

E B C 70 D RM D - S273

MODIFICATION CODE (Consult Factory)

- S273 = FOR .093" ± .008" [2.36 mm ± 0.20 mm] THICK MATING PCB
- S664 = FOR .125" ± .008" [3.18 mm ± 0.20 mm] THICK MATING PCB

MOUNTING STYLE (Opposite Page)

- N = No Mounting
- D = Flush Mounting
- T = Flush Mounting With Threaded Inserts
- Z = Flush Mounting With Side Holes

TERMINATION TYPE (Opposite Page)

- RS = .025" [0.64 mm] Square Dip Solder
- RM = .025" [0.64 mm] Square Wire Wrap
- TA, TB, TM = .025" [0.64 mm] Square Right Angle

READOUT (Opposite Page)

- D = Dual
- H = Half Loaded

NUMBER OF CONTACT POSITIONS

See Chart Below

CONTACT CENTERS

- C = .100" [2.54 mm]

DIMENSIONS Dimensions in [] are in millimeters, all others are in inches.

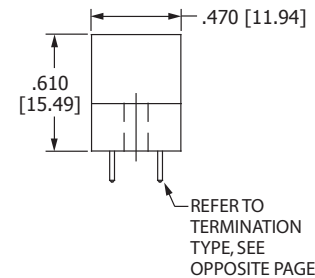
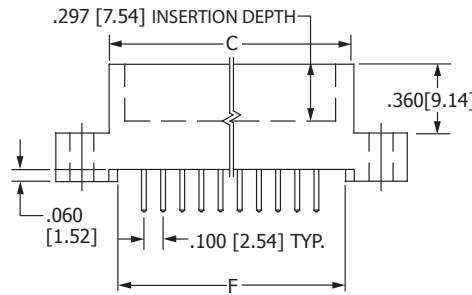
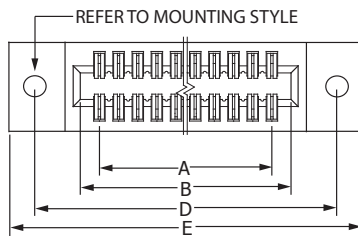

Tolerances on non-critical dimensions may vary slightly due to shrinkage differential per insulator material; Consult factory.

POSITIONS/ CONTACTS	INCHES						MILLIMETERS					
	A±.008	B±.008	C±.015	D±.010	E±.020	F±.015	A±0.20	B±0.20	C±0.38	D±0.25	E±0.51	F±0.38
06/12	0.500	0.700	0.860	1.175	1.435	0.750	12.70	17.78	21.84	29.85	36.45	19.05
07/14*	0.600	0.800	0.960	1.275	1.535	0.850	15.24	20.32	24.38	32.39	38.99	21.59
08/16*	0.700	0.900	1.060	1.375	1.635	0.950	17.78	22.86	26.92	34.93	41.53	24.13
10/20	0.900	1.100	1.260	1.575	1.835	1.150	22.86	27.94	32.00	40.01	46.61	29.21
12/24	1.100	1.300	1.460	1.775	2.035	1.350	27.94	33.02	37.08	45.09	51.69	34.29
15/30*	1.400	1.600	1.760	2.075	2.335	1.650	35.56	40.64	44.70	52.71	59.31	41.91
17/34	1.600	1.800	1.960	2.275	2.535	1.850	40.64	45.72	49.78	57.79	64.39	46.99
18/36	1.700	1.900	2.060	2.375	2.635	1.950	43.18	48.26	52.32	60.33	66.93	49.53
20/40*	1.900	2.100	2.260	2.575	2.835	2.150	48.26	53.34	57.40	65.41	72.01	54.61
22/44	2.100	2.300	2.460	2.775	3.035	2.350	53.34	58.42	62.48	70.49	77.09	59.69
24/48*	2.300	2.500	2.660	2.975	3.235	2.550	58.42	63.50	67.56	75.57	82.17	64.77
25/50*	2.400	2.600	2.760	3.075	3.335	2.650	60.96	66.04	70.10	78.11	84.71	67.31
28/56	2.700	2.900	3.060	3.375	3.635	2.950	68.58	73.66	77.72	85.73	92.33	74.93
30/60	2.900	3.100	3.260	3.575	3.835	3.150	73.66	78.74	82.80	90.81	97.41	80.01
31/62*	3.000	3.200	3.360	3.675	3.935	3.250	76.20	81.28	85.34	93.35	99.95	82.55
35/70	3.400	3.600	3.760	4.075	4.335	3.650	86.36	91.44	95.50	103.51	110.11	92.71
36/72	3.500	3.700	3.860	4.175	4.435	3.750	88.90	93.98	98.04	106.05	112.65	95.25
40/80*	3.900	4.100	4.260	4.575	4.835	4.150	99.06	104.14	108.20	116.21	122.81	105.41
43/86	4.200	4.400	4.560	4.875	5.135	4.450	106.68	111.76	115.82	123.83	130.43	113.03
44/88*	4.300	4.500	4.660	4.975	5.235	4.550	109.22	114.30	118.36	126.37	132.97	115.57
49/98*	4.800	5.000	5.160	5.475	5.735	5.050	121.92	127.00	131.06	139.07	145.67	128.27
50/100	4.900	5.100	5.260	5.575	5.835	5.150	124.46	129.54	133.60	141.61	148.21	130.81
55/110	5.400	5.600	5.760	6.075	6.335	5.650	137.16	142.24	146.30	154.31	160.91	143.51
60/120*	5.900	6.100	6.260	6.575	6.835	6.150	149.86	154.94	159.00	167.01	173.61	156.21
61/122	6.000	6.200	6.360	6.675	6.935	6.250	152.40	157.48	161.54	169.55	176.15	158.75
65/130*	6.400	6.600	6.760	7.075	7.335	6.650	162.56	167.64	171.70	179.71	186.31	168.91
70/140	6.900	7.100	7.260	7.575	7.835	7.150	175.26	180.34	184.40	192.41	199.01	181.61

* Consult factory for availability.