

## 300 mA CMOS LDO with Shutdown, Bypass and Independent Delayed Reset Function

### Features

- LDO with Integrated Microcontroller Reset Monitor Functionality
- Low Input Supply Current (80  $\mu$ A, typical)
- Very Low Dropout Voltage
- 10  $\mu$ sec (typ.) Wake-Up Time from  $\overline{\text{SHDN}}$
- 300 mA Output Current
- Standard or Custom Output and Detected Voltages
- Power-Saving Shutdown Mode
- Bypass Input for Quiet Operation
- Separate Input for Detected Voltage
- 140 msec Minimum  $\overline{\text{RESET}}$  Output Duration
- Space-Saving MSOP Package
- Specified Junction Temperature Range:  
-40°C to +125°C

### Applications

- Battery-Operated Systems
- Portable Computers
- Medical Instruments
- Pagers
- Cellular / GSM / PHS Phones

### Related Literature

- AN765, "Using Microchip's Micropower LDOs", DS00765.
- AN766, "Pin-Compatible CMOS Upgrades to Bipolar LDOs", DS00766.
- AN792, "A Method to Determine How Much Power a SOT23 Can Dissipate in an Application", DS00792.

### Package Type

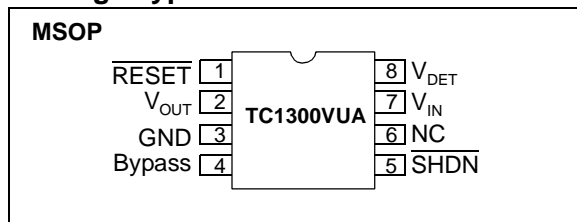

### General Description

The TC1300 combines a low dropout regulator and a microcontroller reset monitor in an 8-Pin MSOP package. Total supply current is 80  $\mu$ A (typical), 20 to 60 times lower than bipolar regulators.

The TC1300 has a precise output with a typical accuracy of  $\pm 0.5\%$ . Other key features include low noise operation, low dropout voltage and internal feed-forward compensation for fast response to step changes in load. The TC1300 has both over-temperature and over-current protection. When the shutdown control ( $\overline{\text{SHDN}}$ ) is low, the regulator output voltage falls to zero,  $\overline{\text{RESET}}$  output remains valid and supply current is reduced to 30  $\mu$ A (typical). The TC1300 is rated for 300 mA of output current and stable with a 1  $\mu$ F output capacitor.

An active-low  $\overline{\text{RESET}}$  is asserted when the detected voltage ( $V_{\text{DET}}$ ) falls below the reset voltage threshold. The  $\overline{\text{RESET}}$  output remains low for 300 msec (typical) after  $V_{\text{DET}}$  rises above reset threshold. The TC1300 also has a fast wake-up response time (10  $\mu$ sec., typical) when released from shutdown.

### Typical Application Circuit

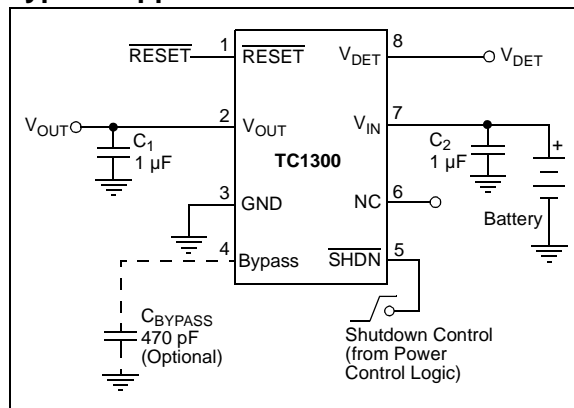

## 1.0 ELECTRICAL CHARACTERISTICS

### Absolute Maximum Ratings\*

Input Voltage .....6.5V  
 Output Voltage ..... (V<sub>SS</sub> - 0.3) to (V<sub>IN</sub> + 0.3)  
 Power Dissipation ..... Internally Limited (**Note 6**)  
 Operating Junction Temperature, T<sub>J</sub> ..... - 40°C < T<sub>J</sub> < 150°C  
 Maximum Junction Temperature, T<sub>J</sub> ..... 150°C  
 Storage Temperature..... - 65°C to +150°C  
 Maximum Voltage on Any Pin ..... (V<sub>SS</sub>-0.3) to (V<sub>IN</sub>+0.3)

\***Notice:** Stresses above those listed under “maximum ratings” may cause permanent damage to the device. This is a stress rating only and functional operation of the device at those or any other conditions above those indicated in the operational listings of this specification is not implied. Exposure to maximum rating conditions for extended periods may affect device reliability.

## PIN DESCRIPTIONS

Pin	Description
$\overline{\text{RESET}}$	$\overline{\text{RESET}}$ output remains low while V <sub>DET</sub> is below the reset voltage threshold and for 300 msec after V <sub>DET</sub> rises above reset threshold.
V <sub>OUT</sub>	Regulated Voltage Output
GND	Ground Terminal
Bypass	Reference Bypass Input. Connecting an optional 470 pF to this input further reduces output noise.
$\overline{\text{SHDN}}$	Shutdown Control Input. The regulator is fully enabled when a logic high is applied to this input. The regulator enters shutdown when a logic low is applied to this input. During shutdown, regulator output voltage falls to zero, $\overline{\text{RESET}}$ output remains valid and supply current is reduced to 30 $\mu\text{A}$ (typ.).
NC	No connect
V <sub>IN</sub>	Power Supply Input
V <sub>DET</sub>	Detected Input Voltage. V <sub>DET</sub> and V <sub>IN</sub> can be connected together.

## ELECTRICAL CHARACTERISTICS

V<sub>IN</sub> = V<sub>OUT</sub> + 1V, I<sub>L</sub> = 0.1 mA, C<sub>L</sub> = 3.3  $\mu\text{F}$ ,  $\overline{\text{SHDN}} > V_{IH}$ , T<sub>A</sub> = 25°C, unless otherwise noted. **BOLDFACE** type specifications apply for junction temperature (**Note 8**) of -40°C to +125°C.

Parameters	Sym	Min	Typ	Max	Units	Conditions
Input Operating Voltage	V <sub>IN</sub>	<b>2.7</b>	—	<b>6.0</b>	V	<b>Note 7</b>
Maximum Output Current	I <sub>OUTMAX</sub>	<b>300</b>	—	—	mA	
Output Voltage	V <sub>OUT</sub>	— <b>V<sub>R</sub> - 2.5%</b>	V <sub>R</sub> $\pm$ 0.5% —	— <b>V<sub>R</sub> + 2.5%</b>	V	<b>Note 1</b>
V <sub>OUT</sub> Temperature Coefficient	$\Delta V_{OUT}/\Delta T$	—	<b>25</b>	—	ppm/°C	<b>Note 2</b>
Line Regulation	$\Delta V_{OUT}/\Delta V_{IN}$	—	0.02	<b>0.35</b>	%	(V <sub>R</sub> + 1V) $\leq$ V <sub>IN</sub> $\leq$ 6V
Load Regulation	$\Delta V_{OUT}/V_{OUT}$	—	0.5	<b>2.0</b>	%	I <sub>L</sub> = 0.1 mA to I <sub>OUTMAX</sub> , <b>Note 3</b>

**Note 1:** V<sub>R</sub> is the regulator output voltage setting.

$$2: TC_{V_{OUT}} = \frac{(V_{OUTMAX} - V_{OUTMIN}) \times 10^6}{V_{OUT} \times \Delta T}$$

- Regulation is measured at a constant junction temperature using low duty cycle pulse testing. Load regulation is tested over a load range from 0.1 mA to the maximum specified output current. Changes in output voltage due to heating effects are covered by the thermal regulation specification.
- Dropout voltage is defined as the input to output differential at which the output voltage drops 2% below its nominal value measured at a 1V differential.
- Thermal Regulation is defined as the change in output voltage at a time t after a change in power dissipation is applied, excluding load or line regulation effects. Specifications are for a current pulse equal to I<sub>LMAX</sub> at V<sub>IN</sub> = 6V for t = 10 msec.
- The maximum allowable power dissipation is a function of ambient temperature, the maximum allowable junction temperature and the thermal resistance from junction-to-air (i.e. T<sub>A</sub>, T<sub>J</sub>,  $\theta_{JA}$ ). Exceeding the maximum allowable power dissipation causes the device to initiate thermal shutdown. Please see Section 4.0, “Thermal Considerations”, of this data sheet for more details.
- The minimum V<sub>IN</sub> has to meet two conditions: V<sub>IN</sub>  $\geq$  2.7V and V<sub>IN</sub>  $\geq$  (V<sub>R</sub> + V<sub>DROPOUT</sub>).
- The junction temperature of the device is approximated by soaking the device under test at an ambient temperature equal to the desired junction temperature. The test time is small enough such that the rise in the junction temperature over the ambient temperature is not significant.

## ELECTRICAL CHARACTERISTICS (CONTINUED)

$V_{IN} = V_{OUT} + 1V$ ,  $I_L = 0.1 \text{ mA}$ ,  $C_L = 3.3 \mu\text{F}$ ,  $\overline{\text{SHDN}} > V_{IH}$ ,  $T_A = 25^\circ\text{C}$ , unless otherwise noted. **BOLDFACE** type specifications apply for junction temperature (**Note 8**) of  $-40^\circ\text{C}$  to  $+125^\circ\text{C}$ .

Parameters	Sym	Min	Typ	Max	Units	Conditions
Dropout Voltage ( <b>Note 4</b> )	$V_{IN\_V_{OUT}}$	—	1 70 210	<b>30</b> <b>130</b> <b>390</b>	mV	$I_L = 0.1 \text{ mA}$ $I_L = 100 \text{ mA}$ $I_L = 300 \text{ mA}$
Supply Current	$I_{SS1}$	—	80	<b>160</b>	$\mu\text{A}$	$\overline{\text{SHDN}} = V_{IH}$
Shutdown Supply Current	$I_{SS2}$	—	30	<b>60</b>	$\mu\text{A}$	$\overline{\text{SHDN}} = 0V$
Power Supply Rejection Ratio	PSRR	—	60	—	dB	$f \leq 1 \text{ kHz}$ , $C_{\text{BYPASS}} = 1 \text{ nF}$
Output Short Circuit Current	$I_{\text{OUT\_SC}}$	—	800	1200	mA	$V_{\text{OUT}} = 0V$
Thermal Regulation	$\Delta V_{\text{OUT}}/\Delta P_D$	—	0.04	—	%/W	<b>Note 5</b>
Output Noise	eN	—	900	—	nV/Hz	$f < 1 \text{ kHz}$ , $C_{\text{OUT}} = 1 \mu\text{F}$ , $R_{\text{LOAD}} = 50 \Omega$ , $C_{\text{BYPASS}} = 1 \text{ nF}$
Wake-Up Time (from Shutdown Mode)	$t_{\text{WK}}$	—	10	20	$\mu\text{sec}$	$C_{\text{IN}} = 1 \mu\text{F}$ , $V_{\text{IN}} = 5V$ , $C_{\text{OUT}} = 4.7 \mu\text{F}$ , $I_L = 30 \text{ mA}$ , See Figure 3-2
Settling Time (from Shutdown Mode)	$t_s$	—	50	—	$\mu\text{sec}$	$C_{\text{IN}} = 1 \mu\text{F}$ , $V_{\text{IN}} = 5V$ $C_{\text{OUT}} = 4.7 \mu\text{F}$ $I_L = 30 \text{ mA}$ , See Figure 3-2
Thermal Shutdown Die Temperature	$T_{\text{SD}}$	—	150	—	$^\circ\text{C}$	
Thermal Shutdown Hysteresis	$T_{\text{HYS}}$	—	10	—	$^\circ\text{C}$	
Thermal Resistance Junction to Case	$R_{\theta\text{JA}}$	—	200	—	$^\circ\text{C/Watt}$	EIA/JEDEC JESD51-751-7 4-Layer Board
SHDN Input High Threshold	$V_{\text{IH}}$	<b>45</b>	—	—	$\%V_{\text{IN}}$	$V_{\text{IN}} = 2.5V$ to $6.0V$
SHDN Input Low Threshold	$V_{\text{IL}}$	—	—	<b>15</b>	$\%V_{\text{IN}}$	$V_{\text{IN}} = 2.5V$ to $6.0V$

**Note 1:**  $V_R$  is the regulator output voltage setting.

$$2: \text{TCV}_{\text{OUT}} = \frac{(V_{\text{OUTMAX}} - V_{\text{OUTMIN}}) \times 10^6}{V_{\text{OUT}} \times \Delta T}$$

- Regulation is measured at a constant junction temperature using low duty cycle pulse testing. Load regulation is tested over a load range from 0.1 mA to the maximum specified output current. Changes in output voltage due to heating effects are covered by the thermal regulation specification.
- Dropout voltage is defined as the input to output differential at which the output voltage drops 2% below its nominal value measured at a 1V differential.
- Thermal Regulation is defined as the change in output voltage at a time  $t$  after a change in power dissipation is applied, excluding load or line regulation effects. Specifications are for a current pulse equal to  $I_{L_{\text{MAX}}}$  at  $V_{\text{IN}} = 6V$  for  $t = 10 \text{ msec}$ .
- The maximum allowable power dissipation is a function of ambient temperature, the maximum allowable junction temperature and the thermal resistance from junction-to-air (i.e.  $T_A$ ,  $T_J$ ,  $\theta_{\text{JA}}$ ). Exceeding the maximum allowable power dissipation causes the device to initiate thermal shutdown. Please see Section 4.0, "Thermal Considerations", of this data sheet for more details.
- The minimum  $V_{\text{IN}}$  has to meet two conditions:  $V_{\text{IN}} \geq 2.7V$  and  $V_{\text{IN}} \geq (V_R + V_{\text{DROPOUT}})$ .
- The junction temperature of the device is approximated by soaking the device under test at an ambient temperature equal to the desired junction temperature. The test time is small enough such that the rise in the junction temperature over the ambient temperature is not significant.

# TC1300

## ELECTRICAL CHARACTERISTICS (CONTINUED)

$V_{IN} = V_{OUT} + 1V$ ,  $I_L = 0.1 \text{ mA}$ ,  $C_L = 3.3 \mu\text{F}$ ,  $\overline{\text{SHDN}} > V_{IH}$ ,  $T_A = 25^\circ\text{C}$ , unless otherwise noted. **BOLDFACE** type specifications apply for junction temperature (**Note 8**) of  $-40^\circ\text{C}$  to  $+125^\circ\text{C}$ .

Parameters	Sym	Min	Typ	Max	Units	Conditions
<b>RESET Output</b>						
Voltage Range	$V_{DET}$	1.0 <b>1.2</b>	—	6.0 <b>6.0</b>	V	$T_A = 0^\circ\text{C}$ to $+70^\circ\text{C}$ $T_A = -40^\circ\text{C}$ to $+125^\circ\text{C}$
Reset Threshold	$V_{TH}$	2.59	2.63	2.66	V	TC1300R-XX, $T_A = +25^\circ\text{C}$
		<b>2.55</b>	—	<b>2.70</b>		TC1300R-XX, $T_A = -40^\circ\text{C}$ to $+125^\circ\text{C}$
		2.36	2.40	2.43		TC1300Y-XX, $T_A = +25^\circ\text{C}$
		<b>2.32</b>	—	<b>2.47</b>		TC1300Y-XX, $T_A = -40^\circ\text{C}$ to $+125^\circ\text{C}$
Reset Threshold Tempco	$\Delta V_{TH} / \Delta T$	—	30	—	ppm/ $^\circ\text{C}$	
$V_{DET}$ to Reset Delay	$t_{RPD}$	—	160	—	$\mu\text{sec}$	$V_{DET} = V_{TH}$ to $(V_{TH} - 100 \text{ mV})$
Reset Active Timeout Period	$t_{RPU}$	<b>140</b>	300	<b>560</b>	msec	
RESET Output Voltage Low	$V_{OL}$	—	—	0.3	V	$V_{DET} = V_{TH} \text{ min}$ , $I_{SINK} = 1.2 \text{ mA}$
RESET Output Voltage High	$V_{OH}$	$0.8 V_{DET}$	—	—	V	$V_{DET} > V_{TH} \text{ max}$ , $I_{SOURCE} = 500 \mu\text{A}$

**Note 1:**  $V_R$  is the regulator output voltage setting.

$$2: TCV_{OUT} = \frac{(V_{OUTMAX} - V_{OUTMIN}) \times 10^6}{V_{OUT} \times \Delta T}$$

- Regulation is measured at a constant junction temperature using low duty cycle pulse testing. Load regulation is tested over a load range from 0.1 mA to the maximum specified output current. Changes in output voltage due to heating effects are covered by the thermal regulation specification.
- Dropout voltage is defined as the input to output differential at which the output voltage drops 2% below its nominal value measured at a 1V differential.
- Thermal Regulation is defined as the change in output voltage at a time  $t$  after a change in power dissipation is applied, excluding load or line regulation effects. Specifications are for a current pulse equal to  $I_{LMAX}$  at  $V_{IN} = 6V$  for  $t = 10 \text{ msec}$ .
- The maximum allowable power dissipation is a function of ambient temperature, the maximum allowable junction temperature and the thermal resistance from junction-to-air (i.e.  $T_A$ ,  $T_J$ ,  $\theta_{JA}$ ). Exceeding the maximum allowable power dissipation causes the device to initiate thermal shutdown. Please see Section 4.0, "Thermal Considerations", of this data sheet for more details.
- The minimum  $V_{IN}$  has to meet two conditions:  $V_{IN} \geq 2.7V$  and  $V_{IN} \geq (V_R + V_{DROPOUT})$ .
- The junction temperature of the device is approximated by soaking the device under test at an ambient temperature equal to the desired junction temperature. The test time is small enough such that the rise in the junction temperature over the ambient temperature is not significant.

## 2.0 TYPICAL CHARACTERISTICS

**Note:** The graphs and tables provided following this note are a statistical summary based on a limited number of samples and are provided for informational purposes only. The performance characteristics listed herein are not tested or guaranteed. In some graphs or tables, the data presented may be outside the specified operating range (e.g., outside specified power supply range) and therefore outside the warranted range.

Junction temperature ( $T_J$ ) is approximated by soaking the device under test at an ambient temperature equal to the desired Junction temperature. The test time is small enough such that the rise in the Junction temperature over the Ambient temperature is not significant.

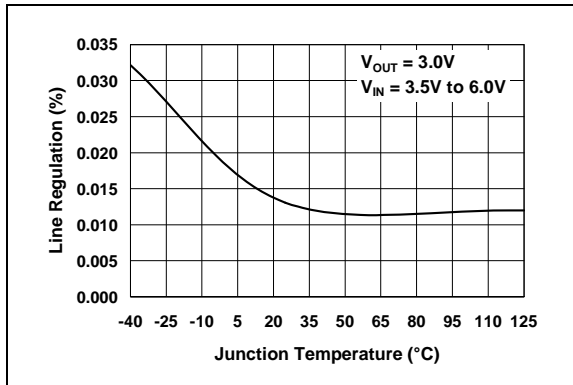

**FIGURE 2-1:** Line Regulation vs. Temperature.

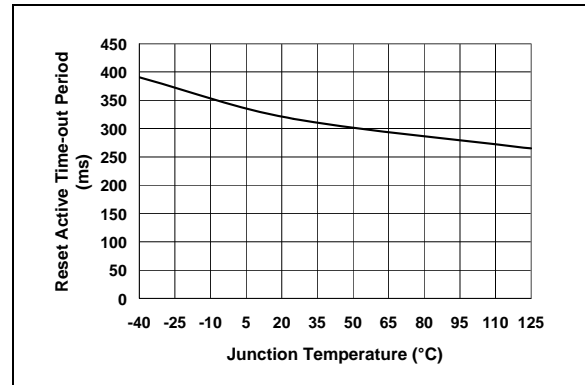

**FIGURE 2-4:** Reset Active Time-out Period vs. Temperature.

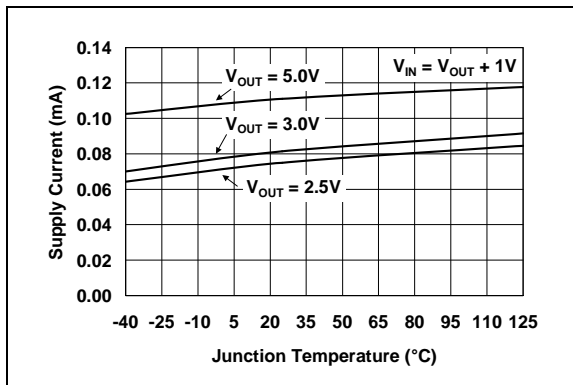

**FIGURE 2-2:** Supply Current vs. Temperature.

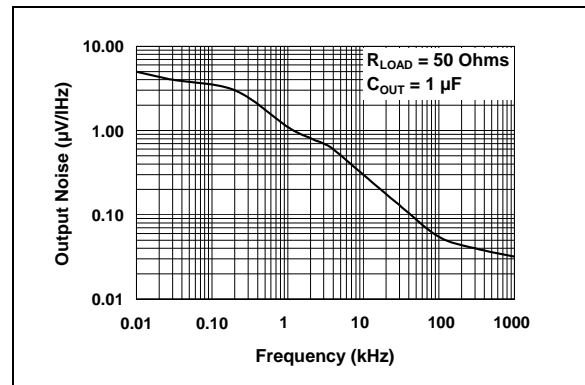

**FIGURE 2-5:** Output Noise vs. Frequency.

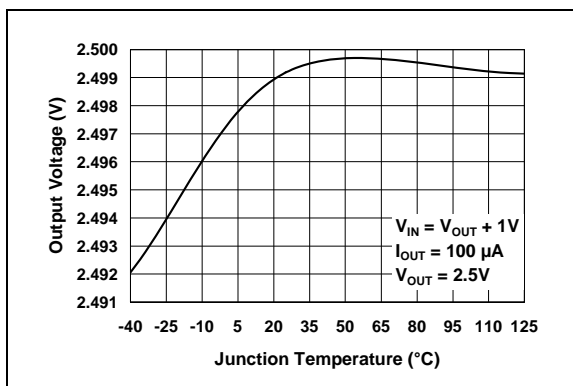

**FIGURE 2-3:** Normalized  $V_{OUT}$  vs. Temperature.

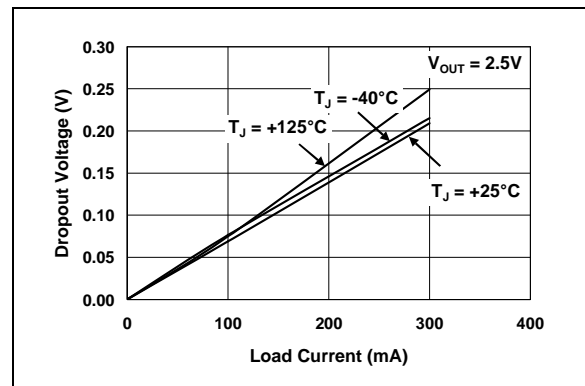

**FIGURE 2-6:** Dropout Voltage vs. Load Current (2.5V).

## 2.0 TYPICAL CHARACTERISTICS (CON'T)

Junction temperature ( $T_J$ ) is approximated by soaking the device under test at an ambient temperature equal to the desired Junction temperature. The test time is small enough such that the rise in the Junction temperature over the Ambient temperature is not significant.

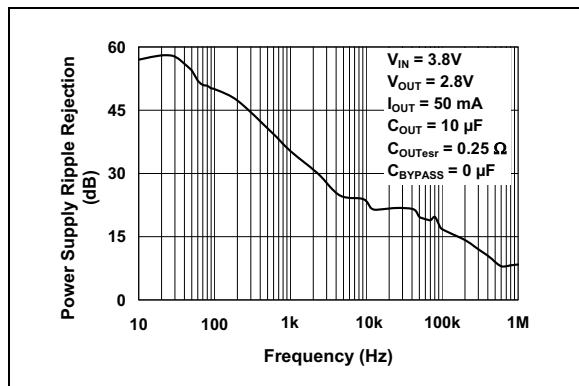

**FIGURE 2-7:** Power Supply Rejection Ratio vs. Frequency.

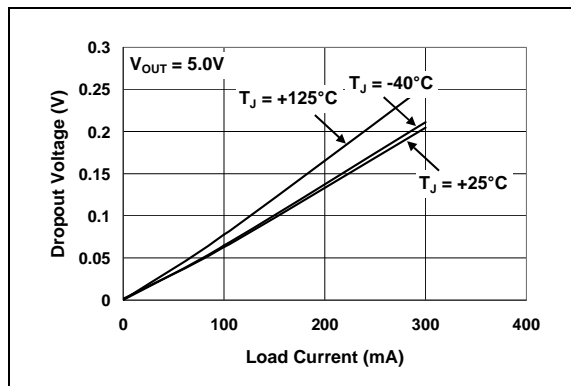

**FIGURE 2-10:** Dropout Voltage vs. Load Current (5.0V).

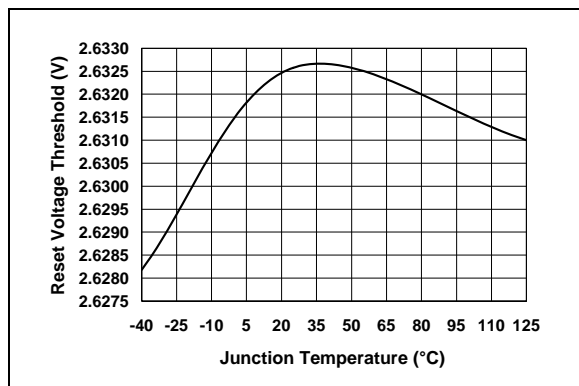

**FIGURE 2-8:** Reset Voltage Threshold vs. Junction Temperature.

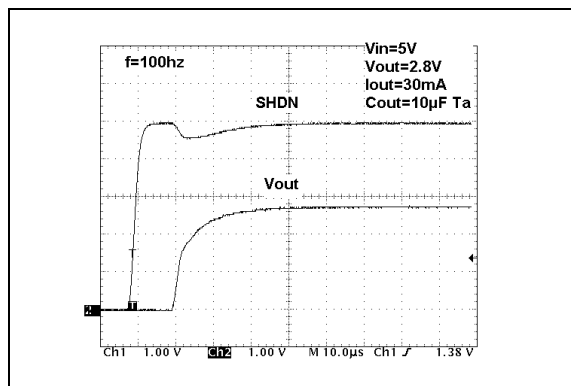

**FIGURE 2-11:** Wake-Up Response Time.

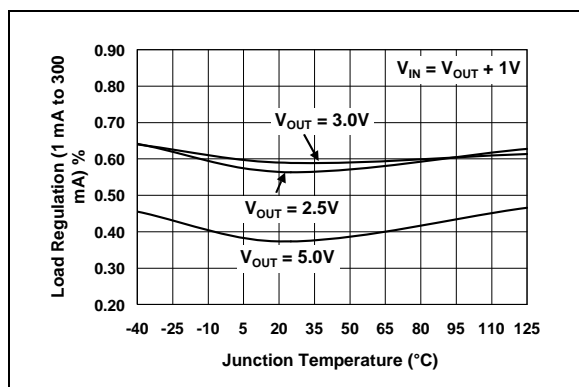

**FIGURE 2-9:** Load Regulation vs. Temperature.

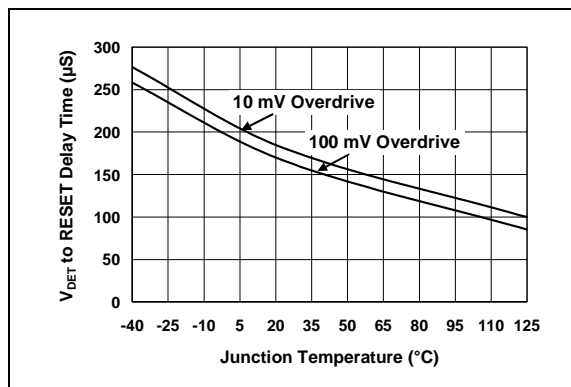

**FIGURE 2-12:**  $V_{DET}$  to Reset Delay vs. Temperature.

## 2.0 TYPICAL CHARACTERISTICS (CON'T)

Junction temperature ( $T_J$ ) is approximated by soaking the device under test at an ambient temperature equal to the desired Junction temperature. The test time is small enough such that the rise in the Junction temperature over the Ambient temperature is not significant.

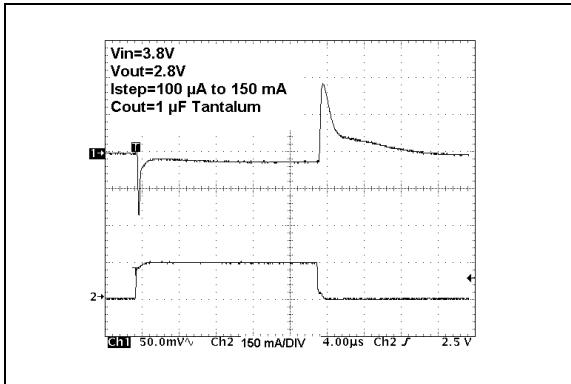

**FIGURE 2-13:** Load Transient Response  
1  $\mu$ F Output Capacitor.

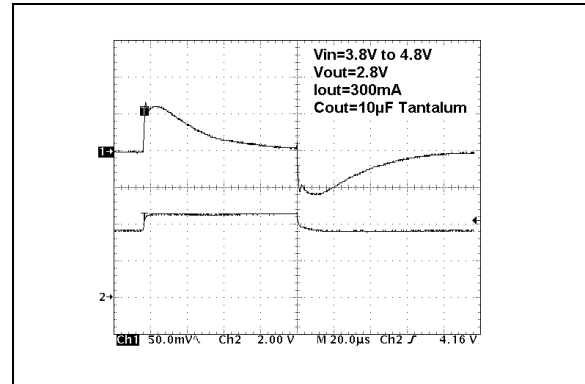

**FIGURE 2-16:** Line Transient Response  
10  $\mu$ F Output Capacitor.

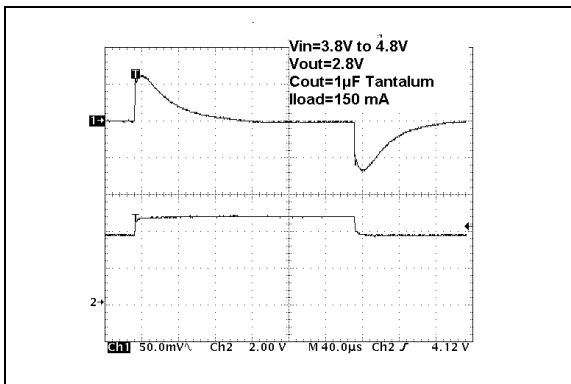

**FIGURE 2-14:** Line Transient Response  
1  $\mu$ F Output Capacitor.

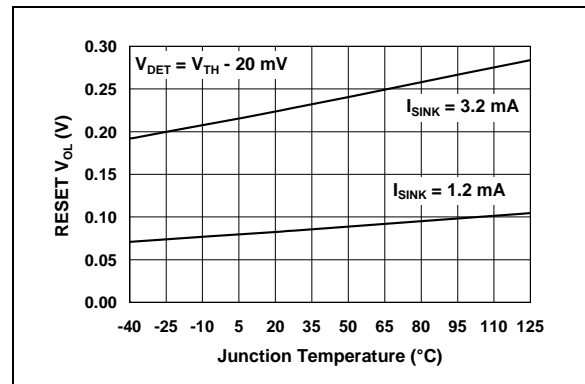

**FIGURE 2-17:** RESET Output Voltage Low  
vs. Junction Temperature.

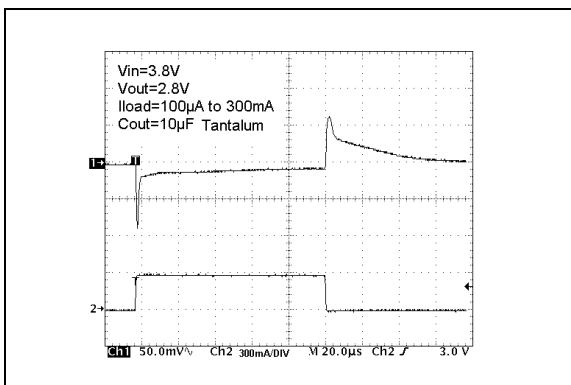

**FIGURE 2-15:** Load Transient Response  
10  $\mu$ F Output Capacitor.

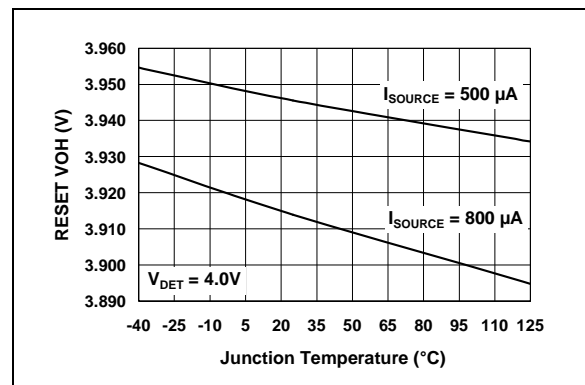

**FIGURE 2-18:** RESET Output Voltage High  
vs. Junction Temperature.

## 3.0 DETAILED DESCRIPTION

The TC1300 is a combination of a fixed output, low dropout regulator and a microcontroller monitor/RESET. Unlike bipolar regulators, the TC1300 supply current does not increase with load current. In addition,  $V_{OUT}$  remains stable and within regulation over the entire specified operating load range (0 mA to 300 mA) and operating input voltage range (2.7V to 6.0V).

Figure 3-1 shows a typical application circuit. The regulator is enabled any time the shutdown input (SHDN) is above  $V_{IH}$ . The regulator is shutdown (disabled) when SHDN is at or below  $V_{IL}$ . SHDN may be controlled by a CMOS logic gate or an I/O port of a microcontroller. If the SHDN input is not required, it should be connected directly to the input supply. While in shutdown, supply current decreases to 30  $\mu$ A (typical),  $V_{OUT}$  falls to zero and RESET remains valid.

### 3.1 RESET Output

The RESET output is driven active-low within 160  $\mu$ sec of  $V_{DET}$  falling through the reset voltage threshold. RESET is maintained active for a minimum of 140 msec after  $V_{DET}$  rises above the reset threshold. The TC1300 has an active-low RESET output. The output of the TC1300 is valid down to  $V_{DET} = 1V$  and is optimized to reject fast transient glitches on the  $V_{DET}$  line.

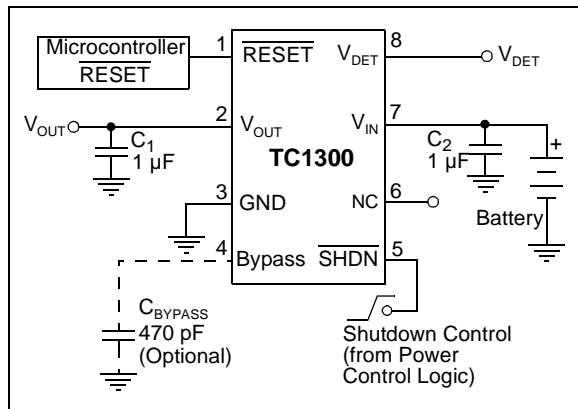

FIGURE 3-1: Typical Application Circuit.

### 3.2 Output Capacitor

A 1  $\mu$ F (min) capacitor from  $V_{OUT}$  to ground is required. A 1  $\mu$ F capacitor should also be connected from  $V_{IN}$  to GND if there is more than 10 inches of wire between the regulator and the AC filter capacitor, or if a battery is used as the power source. As with all low dropout regulators, a minimum output capacitance is required to stabilize the output voltage. For the TC1300, a minimum of 1  $\mu$ F of output capacitance is enough to stabilize the device over the entire operating load and line range. The selected output capacitor plays an important role in compensating the LDO regulator. For the

TC1300, the selected output capacitor equivalent series resistance (ESR) range is 0.1 ohms to 5 ohms when using 1  $\mu$ F of output capacitance, and 0.01 ohms to 5 ohms when using 10  $\mu$ F of output capacitance. Because of the ESR requirement, tantalum and aluminum electrolytic capacitors are recommended. Aluminum electrolytic capacitors are not recommended for operation at temperatures below -25°C. When operating from sources other than batteries, rejection and transient responses can be improved by increasing the value of the input and output capacitors and employing passive filtering techniques.

### 3.3 Bypass Input (Optional)

An optional 470 pF capacitor connected from the Bypass input to ground reduces noise present on the internal reference, which in turn significantly reduces output noise and improves PSRR performance. This input may be left unconnected. Larger capacitor values may be used, but results in a longer time period to rated output voltage when power is initially applied.

### 3.4 Turn On Response

The turn-on response is defined as two separate response categories, Wake-Up Time ( $t_{WK}$ ) and Settling Time ( $t_s$ ).

The TC1300 has a fast Wake-Up Time (10  $\mu$ sec typical) when released from shutdown. See Figure 3-2 for the Wake-Up Time designated as  $t_{WK}$ . The Wake-Up Time is defined as the time it takes for the output to rise to 2% of the  $V_{OUT}$  value after being released from shutdown.

The total turn-on response is defined as the Settling Time ( $t_s$ ) (see Figure 3-2). Settling Time (inclusive with  $t_{WK}$ ) is defined as the condition when the output is within 2% of its fully enabled value (50  $\mu$ sec typical) when released from shutdown. The settling time of the output voltage is dependent on load conditions and output capacitance on  $V_{OUT}$  (RC response).

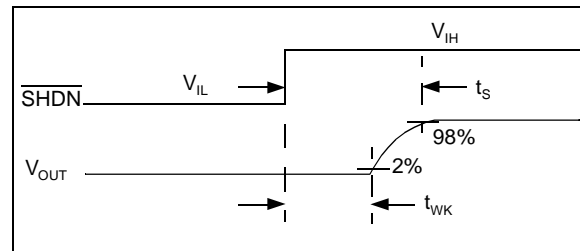

FIGURE 3-2: Wake-Up Response Time.



## 4.0 THERMAL CONSIDERATIONS

### 4.1 Thermal Shutdown

Integrated thermal protection circuitry shuts the regulator off when the die temperature exceeds 150°C. The regulator remains off until the die temperature drops to approximately 140°C.

### 4.2 Power Dissipation

The amount of power the regulator dissipates is primarily a function of input and output voltage, and output current. The following equation is used to calculate worst case *actual* power dissipation:

#### EQUATION

$$P_D \approx (V_{INMAX} - V_{OUTMIN})I_{LOADMAX}$$

Where:

$P_D$  = worst case actual power dissipation  
 $V_{INMAX}$  = maximum voltage on  $V_{IN}$   
 $V_{OUTMIN}$  = minimum regulator output voltage  
 $I_{LOADMAX}$  = maximum output (load) current

The maximum allowable power dissipation,  $P_{DMAX}$ , is a function of the maximum ambient temperature ( $T_{AMAX}$ ), the maximum recommended die temperature (125°C) and the thermal resistance from junction-to-air ( $\theta_{JA}$ ). The MSOP-8 package has a  $\theta_{JA}$  of approximately 200°C/Watt when mounted on a FR4 dielectric copper clad PC board.

#### EQUATION

$$P_{DMAX} = \frac{(T_{JMAX} - T_{AMAX})}{\theta_{JA}}$$

The worst case actual power dissipation equation can be used in conjunction with the LDO maximum allowable power dissipation equation to ensure regulator thermal operation is within limits. For example:

Given:

$$\begin{aligned} V_{INMAX} &= 4.1V \\ V_{OUTMIN} &= 3.0V - 2.5\% \\ I_{LOADMAX} &= 200\text{ mA} \\ T_{JMAX} &= 125^\circ\text{C} \\ T_{AMAX} &= 55^\circ\text{C} \\ \theta_{JA} &= 200^\circ\text{C/W} \end{aligned}$$

Find:

#### EQUATION: ACTUAL POWER DISSIPATION

$$\begin{aligned} P_D &\approx (V_{INMAX} - V_{OUTMIN})I_{LOADMAX} \\ &= [(4.1) - (3.0 \times .975)]200 \times 10^{-3} \\ &= 220\text{ mW} \end{aligned}$$

#### EQUATION: MAXIMUM ALLOWABLE POWER DISSIPATION

$$\begin{aligned} P_{DMAX} &= \frac{(T_{JMAX} - T_{AMAX})}{\theta_{JA}} \\ &= \frac{(125 - 55)}{200} \\ &= 350\text{ mW} \end{aligned}$$

In this example, the TC1300 dissipates a maximum of only 220 mW; below the allowable limit of 350 mW. In a similar manner, the maximum actual power dissipation equation and the maximum allowable power dissipation equation can be used to calculate maximum current and/or input voltage limits. For example, the maximum allowable  $V_{IN}$  is found by substituting the maximum allowable power dissipation of 350 mW into the actual power dissipation equation, from which  $V_{INMAX} = 4.97V$ .

### 4.3 Layout Considerations

The primary path of heat conduction out of the package is via the package leads. Therefore, layouts having a ground plane, wide traces at the pads and wide power supply bus lines combine to lower  $\theta_{JA}$  and, therefore, increase the maximum allowable power dissipation limit.

# TC1300

## 5.0 PACKAGING INFORMATION

### 5.1 Package Marking Information

8-Lead MSOP

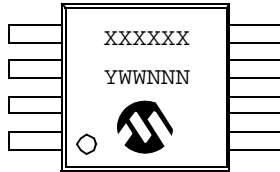

Example:

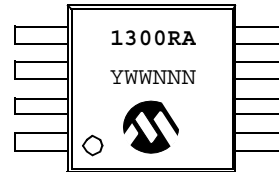

Part Number	Marking Code (XXXXXX)
TC1300R - 2.5VUA	1300RA
TC1300Y - 2.7VUA	1300YF
TC1300R - 2.8VUA	1300RB
TC1300R - 2.85VUA	1300RC
TC1300R - 3.0VUA	1300RD
TC1300R - 3.3VUA	1300RE

**Legend:** XX...X Customer-specific information  
 Y Year code (last digit of calendar year)  
 YY Year code (last 2 digits of calendar year)  
 WW Week code (week of January 1 is week '01')  
 NNN Alphanumeric traceability code  
 (e3) Pb-free JEDEC designator for Matte Tin (Sn)  
 \* This package is Pb-free. The Pb-free JEDEC designator (e3) can be found on the outer packaging for this package.

**Note:** In the event the full Microchip part number cannot be marked on one line, it will be carried over to the next line, thus limiting the number of available characters for customer-specific information.

## 5.2 Package Dimensions

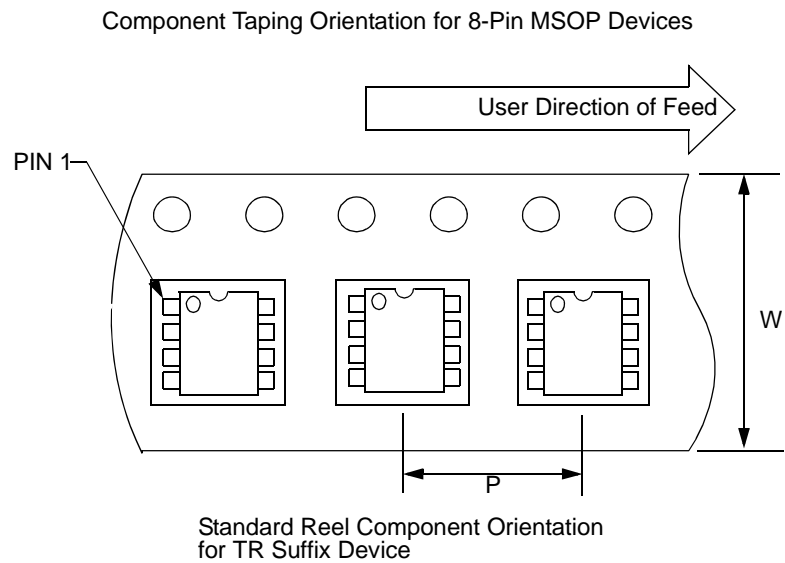

**Carrier Tape, Number of Components Per Reel and Reel Size:**

Package	Carrier Width (W)	Pitch (P)	Part Per Full Reel	Reel Size
8-Pin MSOP	12 mm	8 mm	2500	13 in.

# TC1300

## 8-Lead Plastic Micro Small Outline Package (UA) (MSOP)

**Note:** For the most current package drawings, please see the Microchip Packaging Specification located at <http://www.microchip.com/packaging>

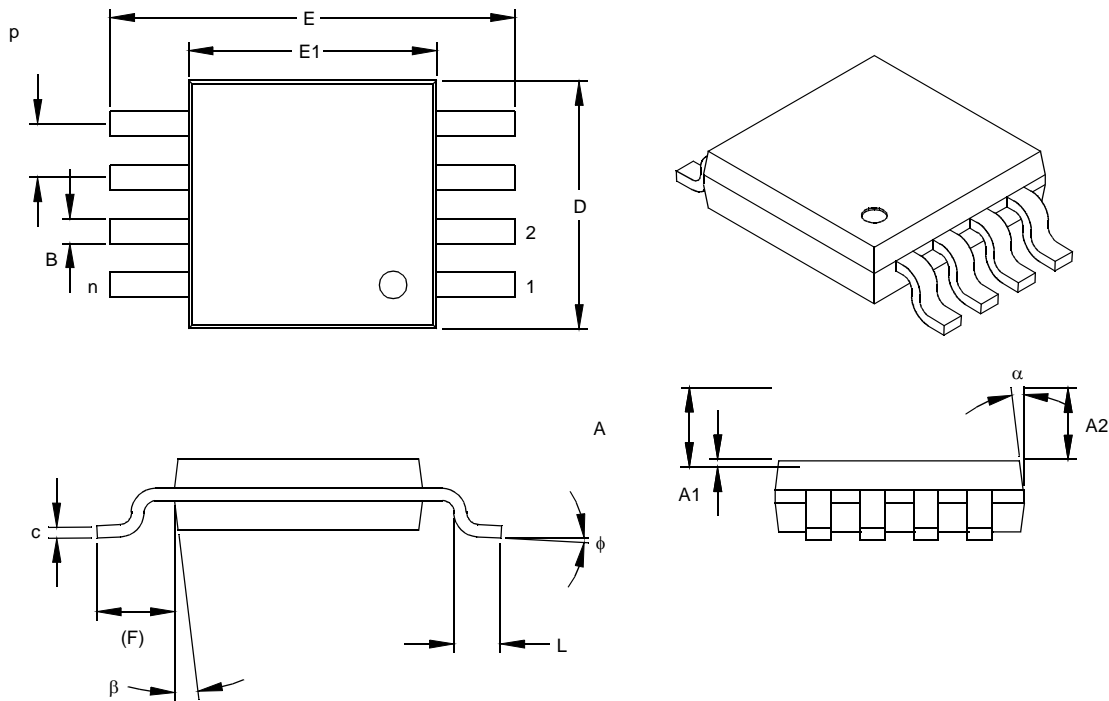

Dimension Limits	Units	INCHES			MILLIMETERS*		
		MIN	NOM	MAX	MIN	NOM	MAX
Number of Pins	n		8				8
Pitch	P	.026			0.65		
Overall Height	A			.044			1.18
Molded Package Thickness	A2	.030	.034	.038	0.76	0.86	0.97
Standoff §	A1	.002		.006	0.05		0.15
Overall Width	E	.184	.193	.200	4.67	4.90	5.08
Molded Package Width	E1	.114	.118	.122	2.90	3.00	3.10
Overall Length	D	.114	.118	.122	2.90	3.00	3.10
Foot Length	L	.016	.022	.028	0.40	0.55	0.70
Footprint (Reference)	F	.035	.037	.039	0.90	0.95	1.00
Foot Angle	φ	0		6	0		6
Lead Thickness	c	.004	.006	.008	0.10	0.15	0.20
Lead Width	B	.010	.012	.016	0.25	0.30	0.40
Mold Draft Angle Top	α		7			7	
Mold Draft Angle Bottom	β		7			7	

\*Controlling Parameter  
§ Significant Characteristic

**Notes:**

Dimensions D and E1 do not include mold flash or protrusions. Mold flash or protrusions shall not exceed .010" (0.254mm) per side.

Drawing No. C04-111

## 6.0 REVISION HISTORY

### Revision D (November 2010)

Added a note to each package outline drawing.

# TC1300

---

---

NOTES:

## PRODUCT IDENTIFICATION SYSTEM

To order or obtain information, e.g., on pricing or delivery, refer to the factory or the listed sales office.

<u>PART NO.</u>	<u>-X.X</u>	<u>X</u>	<u>/XX</u>
Device	Output Voltages	Temperature Range	Package
Device:	TC1300X-X.XXXX:	300mA CMOS LDO w/Shutdown, Bypass & Independent Delayed Reset	
	TC1300X-X.XXXXTR:	300mA CMOS LDO w/Shutdown, Bypass & Independent Delayed Reset (Tape and Reel)	
Output Voltages:	2.5V = 2.5		
	2.7V = 2.7		
RESET Threshold Voltages:	2.8V = 2.8		
	2.85V = 2.85		
- 2.4V = Y	3.0V = 3.0		
- 2.63V = R	3.3V = 3.3		
Temperature Range:	V = -40°C to +125°C		
Package:	UA = Micro Small Outline Package (MSOP), 8-lead		

**Examples:**

- a) TC1300R-2.5VUA: 300mA CMOS LDO w/ Shutdown, Bypass & Independent Delayed Reset, 2.5V output voltage, 2.63V RESET Threshold.
- b) TC1300R-2.8VUA: 300mA CMOS LDO w/Shutdown, Bypass & Independent Delayed Reset, 2.8V output voltage, 2.63V RESET Threshold.
- c) TC1300R-2.85VUA: 300mA CMOS LDO w/ Shutdown, Bypass & Independent Delayed Reset, 2.85V output voltage, 2.63V RESET Threshold.
- d) TC1300R-3.0VUA: 300mA CMOS LDO w/Shutdown, Bypass & Independent Delayed Reset, 3.0V output voltage, 2.63V RESET Threshold.
- e) TC1300R-3.3VUA: 300mA CMOS LDO w/Shutdown, Bypass & Independent Delayed Reset, 3.3V output voltage, 2.63V RESET Threshold.
- f) TC1300R-2.85VUATR: 300mA CMOS LDO w/ Shutdown, Bypass & Independent Delayed Reset, 2.85V output voltage, 2.63V RESET Threshold, tape and reel.
- g) TC1300Y-2.7VUA: 300mA CMOS LDO w/ Shutdown, Bypass & independent Delayed Reset, 2.7V output voltage, 2.4V RESET Threshold.

## Sales and Support

### Data Sheets

Products supported by a preliminary Data Sheet may have an errata sheet describing minor operational differences and recommended workarounds. To determine if an errata sheet exists for a particular device, please contact one of the following:

1. Your local Microchip sales office
2. The Microchip Worldwide Site ([www.microchip.com](http://www.microchip.com))

Please specify which device, revision of silicon and Data Sheet (include Literature #) you are using.

### New Customer Notification System

Register on our web site ([www.microchip.com/cn](http://www.microchip.com/cn)) to receive the most current information on our products.

# TC1300

---

NOTES:



---

**Note the following details of the code protection feature on Microchip devices:**

- Microchip products meet the specification contained in their particular Microchip Data Sheet.
- Microchip believes that its family of products is one of the most secure families of its kind on the market today, when used in the intended manner and under normal conditions.
- There are dishonest and possibly illegal methods used to breach the code protection feature. All of these methods, to our knowledge, require using the Microchip products in a manner outside the operating specifications contained in Microchip's Data Sheets. Most likely, the person doing so is engaged in theft of intellectual property.
- Microchip is willing to work with the customer who is concerned about the integrity of their code.
- Neither Microchip nor any other semiconductor manufacturer can guarantee the security of their code. Code protection does not mean that we are guaranteeing the product as “unbreakable.”

Code protection is constantly evolving. We at Microchip are committed to continuously improving the code protection features of our products. Attempts to break Microchip's code protection feature may be a violation of the Digital Millennium Copyright Act. If such acts allow unauthorized access to your software or other copyrighted work, you may have a right to sue for relief under that Act.

---

Information contained in this publication regarding device applications and the like is provided only for your convenience and may be superseded by updates. It is your responsibility to ensure that your application meets with your specifications. MICROCHIP MAKES NO REPRESENTATIONS OR WARRANTIES OF ANY KIND WHETHER EXPRESS OR IMPLIED, WRITTEN OR ORAL, STATUTORY OR OTHERWISE, RELATED TO THE INFORMATION, INCLUDING BUT NOT LIMITED TO ITS CONDITION, QUALITY, PERFORMANCE, MERCHANTABILITY OR FITNESS FOR PURPOSE. Microchip disclaims all liability arising from this information and its use. Use of Microchip devices in life support and/or safety applications is entirely at the buyer's risk, and the buyer agrees to defend, indemnify and hold harmless Microchip from any and all damages, claims, suits, or expenses resulting from such use. No licenses are conveyed, implicitly or otherwise, under any Microchip intellectual property rights.

**Trademarks**

The Microchip name and logo, the Microchip logo, dsPIC, FlashFlex, KEELOQ, KEELOQ logo, MPLAB, PIC, PICmicro, PICSTART, PIC<sup>32</sup> logo, rPIC, SST, SST Logo, SuperFlash and UNI/O are registered trademarks of Microchip Technology Incorporated in the U.S.A. and other countries.

FilterLab, Hampshire, HI-TECH C, Linear Active Thermistor, MTP, SEEVAL and The Embedded Control Solutions Company are registered trademarks of Microchip Technology Incorporated in the U.S.A.

Silicon Storage Technology is a registered trademark of Microchip Technology Inc. in other countries.

Analog-for-the-Digital Age, Application Maestro, BodyCom, chipKIT, chipKIT logo, CodeGuard, dsPICDEM, dsPICDEM.net, dsPICworks, dsSPEAK, ECAN, ECONOMONITOR, FanSense, HI-TIDE, In-Circuit Serial Programming, ICSP, Mindi, MiWi, MPASM, MPF, MPLAB Certified logo, MPLIB, MPLINK, mTouch, Omniclient Code Generation, PICC, PICC-18, PICDEM, PICDEM.net, PICkit, PICtail, REAL ICE, rLAB, Select Mode, SQI, Serial Quad I/O, Total Endurance, TSHARC, UniWinDriver, WiperLock, ZENA and Z-Scale are trademarks of Microchip Technology Incorporated in the U.S.A. and other countries.

SQTP is a service mark of Microchip Technology Incorporated in the U.S.A.

GestIC and ULPP are registered trademarks of Microchip Technology Germany II GmbH & Co. & KG, a subsidiary of Microchip Technology Inc., in other countries.

All other trademarks mentioned herein are property of their respective companies.

© 2001-2012, Microchip Technology Incorporated, Printed in the U.S.A., All Rights Reserved.

 Printed on recycled paper.

ISBN: 9781620767832

**QUALITY MANAGEMENT SYSTEM**  
**CERTIFIED BY DNV**  
**== ISO/TS 16949 ==**

*Microchip received ISO/TS-16949:2009 certification for its worldwide headquarters, design and wafer fabrication facilities in Chandler and Tempe, Arizona; Gresham, Oregon and design centers in California and India. The Company's quality system processes and procedures are for its PIC<sup>®</sup> MCUs and dsPIC<sup>®</sup> DSCs, KEELOQ<sup>®</sup> code hopping devices, Serial EEPROMs, microperipherals, nonvolatile memory and analog products. In addition, Microchip's quality system for the design and manufacture of development systems is ISO 9001:2000 certified.*



# MICROCHIP

## Worldwide Sales and Service

### AMERICAS

**Corporate Office**  
2355 West Chandler Blvd.  
Chandler, AZ 85224-6199  
Tel: 480-792-7200  
Fax: 480-792-7277  
Technical Support:  
<http://www.microchip.com/support>  
Web Address:  
[www.microchip.com](http://www.microchip.com)

**Atlanta**  
Duluth, GA  
Tel: 678-957-9614  
Fax: 678-957-1455

**Boston**  
Westborough, MA  
Tel: 774-760-0087  
Fax: 774-760-0088

**Chicago**  
Itasca, IL  
Tel: 630-285-0071  
Fax: 630-285-0075

**Cleveland**  
Independence, OH  
Tel: 216-447-0464  
Fax: 216-447-0643

**Dallas**  
Addison, TX  
Tel: 972-818-7423  
Fax: 972-818-2924

**Detroit**  
Farmington Hills, MI  
Tel: 248-538-2250  
Fax: 248-538-2260

**Indianapolis**  
Noblesville, IN  
Tel: 317-773-8323  
Fax: 317-773-5453

**Los Angeles**  
Mission Viejo, CA  
Tel: 949-462-9523  
Fax: 949-462-9608

**Santa Clara**  
Santa Clara, CA  
Tel: 408-961-6444  
Fax: 408-961-6445

**Toronto**  
Mississauga, Ontario,  
Canada  
Tel: 905-673-0699  
Fax: 905-673-6509

### ASIA/PACIFIC

**Asia Pacific Office**  
Suites 3707-14, 37th Floor  
Tower 6, The Gateway  
Harbour City, Kowloon  
Hong Kong  
Tel: 852-2401-1200  
Fax: 852-2401-3431

**Australia - Sydney**  
Tel: 61-2-9868-6733  
Fax: 61-2-9868-6755

**China - Beijing**  
Tel: 86-10-8569-7000  
Fax: 86-10-8528-2104

**China - Chengdu**  
Tel: 86-28-8665-5511  
Fax: 86-28-8665-7889

**China - Chongqing**  
Tel: 86-23-8980-9588  
Fax: 86-23-8980-9500

**China - Hangzhou**  
Tel: 86-571-2819-3187  
Fax: 86-571-2819-3189

**China - Hong Kong SAR**  
Tel: 852-2943-5100  
Fax: 852-2401-3431

**China - Nanjing**  
Tel: 86-25-8473-2460  
Fax: 86-25-8473-2470

**China - Qingdao**  
Tel: 86-532-8502-7355  
Fax: 86-532-8502-7205

**China - Shanghai**  
Tel: 86-21-5407-5533  
Fax: 86-21-5407-5066

**China - Shenyang**  
Tel: 86-24-2334-2829  
Fax: 86-24-2334-2393

**China - Shenzhen**  
Tel: 86-755-8864-2200  
Fax: 86-755-8203-1760

**China - Wuhan**  
Tel: 86-27-5980-5300  
Fax: 86-27-5980-5118

**China - Xian**  
Tel: 86-29-8833-7252  
Fax: 86-29-8833-7256

**China - Xiamen**  
Tel: 86-592-2388138  
Fax: 86-592-2388130

**China - Zhuhai**  
Tel: 86-756-3210040  
Fax: 86-756-3210049

### ASIA/PACIFIC

**India - Bangalore**  
Tel: 91-80-3090-4444  
Fax: 91-80-3090-4123

**India - New Delhi**  
Tel: 91-11-4160-8631  
Fax: 91-11-4160-8632

**India - Pune**  
Tel: 91-20-2566-1512  
Fax: 91-20-2566-1513

**Japan - Osaka**  
Tel: 81-66-152-7160  
Fax: 81-66-152-9310

**Japan - Yokohama**  
Tel: 81-45-471-6166  
Fax: 81-45-471-6122

**Korea - Daegu**  
Tel: 82-53-744-4301  
Fax: 82-53-744-4302

**Korea - Seoul**  
Tel: 82-2-554-7200  
Fax: 82-2-558-5932 or  
82-2-558-5934

**Malaysia - Kuala Lumpur**  
Tel: 60-3-6201-9857  
Fax: 60-3-6201-9859

**Malaysia - Penang**  
Tel: 60-4-227-8870  
Fax: 60-4-227-4068

**Philippines - Manila**  
Tel: 63-2-634-9065  
Fax: 63-2-634-9069

**Singapore**  
Tel: 65-6334-8870  
Fax: 65-6334-8850

**Taiwan - Hsin Chu**  
Tel: 886-3-5778-366  
Fax: 886-3-5770-955

**Taiwan - Kaohsiung**  
Tel: 886-7-213-7828  
Fax: 886-7-330-9305

**Taiwan - Taipei**  
Tel: 886-2-2508-8600  
Fax: 886-2-2508-0102

**Thailand - Bangkok**  
Tel: 66-2-694-1351  
Fax: 66-2-694-1350

### EUROPE

**Austria - Wels**  
Tel: 43-7242-2244-39  
Fax: 43-7242-2244-393

**Denmark - Copenhagen**  
Tel: 45-4450-2828  
Fax: 45-4485-2829

**France - Paris**  
Tel: 33-1-69-53-63-20  
Fax: 33-1-69-30-90-79

**Germany - Munich**  
Tel: 49-89-627-144-0  
Fax: 49-89-627-144-44

**Italy - Milan**  
Tel: 39-0331-742611  
Fax: 39-0331-466781

**Netherlands - Drunen**  
Tel: 31-416-690399  
Fax: 31-416-690340

**Spain - Madrid**  
Tel: 34-91-708-08-90  
Fax: 34-91-708-08-91

**UK - Wokingham**  
Tel: 44-118-921-5869  
Fax: 44-118-921-5820

11/27/12