

### Features

- Standard quarter-brick package/pinout in through-hole or SMT version
- Low cost; Low profile, 0.35" (8.9mm)
- 24V and 48V nominal inputs
- Output current: 8 to 25 Amps
- Output voltages: 1.2/1.5/1.8/2.2/2.5/3.3/5/12V
- Interleaved synchronous-rectifier topology
  - Ultra high efficiency
  - No output reverse conduction
- Outstanding thermal performance
- On/off control, trim & sense functions
- Fully isolated, 2250Vdc (BASIC)
- Output overvoltage protection
- Fully I/O protected; Thermal shutdown
- UL/EN/IEC60950 safety approvals
- Qual/HALT/EMI tested

For applications requiring improved electrical and thermal performance at reduced cost DATEL's new ULQ Series "Quarter-Brick" DC/DC Converters suit perfectly. They measure just 1.45 x 2.30 x 0.35 inches (36.8 x 58.4 x 8.9mm) and fit the industry-standard footprint. You can also "pick-and-place" the ULQ-SMT version optimizing your automated SMT process.

From an 18-36V or 36-75V input, ULQ's deliver outputs of 1.2, 1.5, 1.8, or 2V fully rated at 15 or 25A, 2.5 or 3.3V at 15 or 20A, 5V at 15A and 12V at 8-10A. They employ an interleaved, synchronous-rectifier topology that exploits 100% of their duty cycle. They simultaneously achieve ultra-high efficiency (to 91%), tight line/load regulation ( $\pm 0.125/0.25\%$ ), low noise (25-70mVp-p), and quick step response (200 $\mu$ sec).

A state of the art, single-board, open-frame design with reduced component count, high efficiency, low-on-resistance FET's, and planar magnetics embedded in heavy-copper pc boards all contribute to impressive thermal derating.

The ULQ's feature set includes high isolation (2250Vdc), input pi filters, input undervoltage shutdown, output overvoltage protection, current limiting, short-circuit protection and thermal shutdown. The standard footprint carries on/off control (positive or negative polarity), output trim (+10/-20%) and output sense functions.

All ULQ quarter-bricks are designed to meet the BASIC-insulation requirements of UL/EN/IEC60950 and they will carry the CE mark. Safety certifications, EMC compliance testing and qualification testing (including HALT) are currently in progress. Contact DATEL for latest updates.

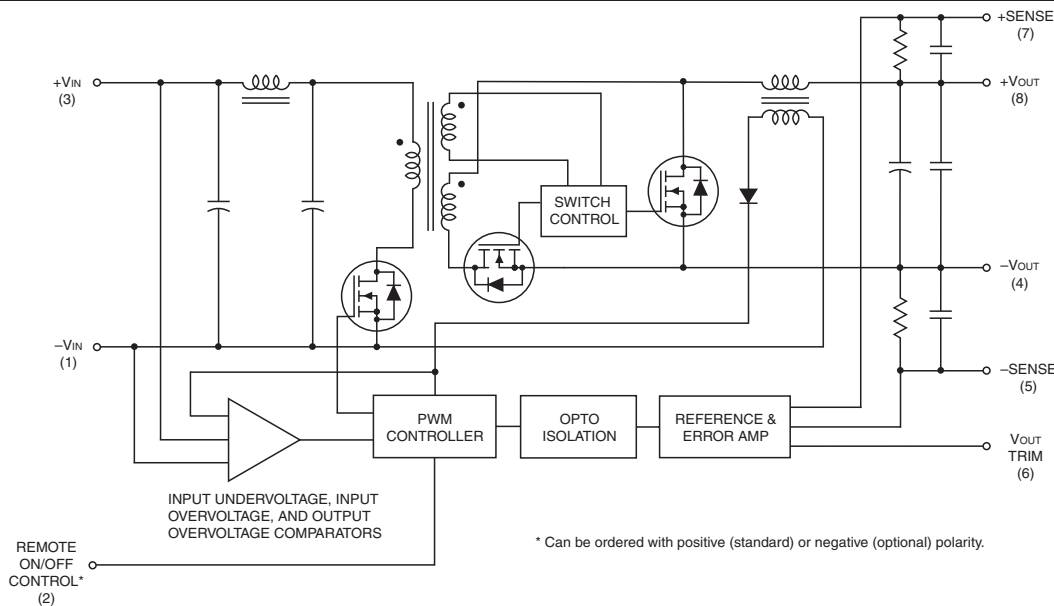

Figure 1. Simplified Schematic

Typical topology is shown.



## Single Output, Low-Profile, Quarter-Brick 8-25 Amp Isolated DC/DC Converters

### Performance Specifications and Ordering Guide <sup>①</sup>

Root Model <sup>⑤</sup>	Output						Input			Efficiency		Package (Case, Pinout)
	V <sub>OUT</sub> (Volts)	I <sub>OUT</sub> <sup>②</sup> (Amps)	R/N (mVp-p) <sup>②</sup>		Regulation (Max.)		V <sub>IN</sub> Nom. (Volts)	Range (Volts)	I <sub>IN</sub> <sup>④</sup> (mA/A)	Min.	Typ.	
			Typ.	Max.	Line	Load <sup>③</sup>						
ULQ-1.2/25-D24P-C	1.2	25	50	100	±0.125%	±0.25%	24	18-36	35/1.9	85.5%	88%	C37/C40, P32
ULQ-1.2/25-D48N-C	1.2	25	50	100	±0.125%	±0.25%	48	36-75	35/0.8	85%	87.5%	C37/C40, P32
ULQ-1.5/15-D48N-C	1.5	15	25	50	±0.125%	±0.25%	48	36-75	35/0.5	87%	89%	C37/C40, P32
ULQ-1.5/25-D24P-C	1.5	25	50	100	±0.125%	±0.25%	24	18-36	50/1.8	85.5%	87.5%	C37/C40, P32
ULQ-1.5/25-D48N-C	1.5	25	45	75	±0.125%	±0.25%	48	36-75	30/0.9	85%	87%	C37/C40, P32
ULQ-1.8/15-D48N-C	1.8	15	25	50	±0.125%	±0.25%	48	36-75	35/0.6	87.5%	89%	C37/C40, P32
ULQ-1.8/25-D24P-C	1.8	25	50	100	±0.125%	±0.25%	24	18-36	90/2.2	85.5%	87.5%	C37/C40, P32
ULQ-1.8/25-D48N-C	1.8	25	70	100	±0.25%	±0.25%	48	36-75	45/1.1	85.5%	87.5%	C37/C40, P32
ULQ-2/15-D48N-C	2	15	25	50	±0.125%	±0.25%	48	36-75	45/0.6	87%	89%	C37/C40, P32
ULQ-2/25-D24P-C	2	25	50	100	±0.125%	±0.25%	24	18-36	50/2.4	86%	88%	C37/C40, P32
ULQ-2/25-D48N-C	2	25	70	100	±0.25%	±0.25%	48	36-75	50/1.2	86%	88%	C37/C40, P32
ULQ-2.5/15-D48N-C	2.5	15	35	55	±0.125%	±0.25%	48	36-75	45/0.9	88%	89.5%	C37/C40, P32
ULQ-2.5/20-D24P-C	2.5	20	50	100	±0.125%	±0.25%	24	18-36	50/2.4	86.5%	88.5%	C37/C40, P32
ULQ-2.5/20-D48N-C	2.5	20	60	100	±0.125%	±0.25%	48	36-75	45/1.2	86.5%	88.5%	C37/C40, P32
ULQ-3.3/15-D48N-C	3.3	15	45	75	±0.125%	±0.25%	48	36-75	45/1.2	88.5%	90.5%	C37/C40, P32
ULQ-3.3/20-D24P-C	3.3	20	50	100	±0.125%	±0.25%	24	18-36	80/3.1	87.5%	89.5%	C37/C40, P32
ULQ-3.3/20-D48N-C	3.3	20	45	75	±0.125%	±0.25%	48	36-75	45/1.6	88%	90%	C37/C40, P32
ULQ-5/15-D24P-C	5	15	50	100	±0.25%	±0.25%	24	18-36	50/3.5	89%	91%	C37/C40, P32
ULQ-5/15-D48N-C	5	15	50	100	±0.1%	±0.4%	48	36-75	50/1.7	89%	91%	C37/C40, P32
ULQ-12/8-D24P-C	12	8	95	130	±0.25%	±0.25%	24	18-36	90/4.4	89%	90.5%	C37/C40, P32
ULQ-12/10-D48N-C	12	10	90	130	±0.25%	±0.25%	48	36-75	80/2.9	88%	90%	C37/C40, P32

- ① Typical at T<sub>A</sub> = +25°C under nominal line voltage and full-load conditions. All models are specified with an external 1µF multi-layer ceramic and 10µF capacitors across their output pins.
- ② Ripple/Noise (R/N) measured over a 20MHz bandwidth.
- ③ Devices have no minimum-load requirements and will regulate under no-load conditions. Regulation specifications describe the output voltage deviation as the line voltage or load is varied from its nominal/midpoint value to either extreme. (Load step = 50%.)
- ④ Nominal line voltage, no load/full load condition.
- ⑤ Please refer to the Part Number Structure when ordering.
- ⑥ Not all model number combinations are available. Consult Murata Power Solutions.

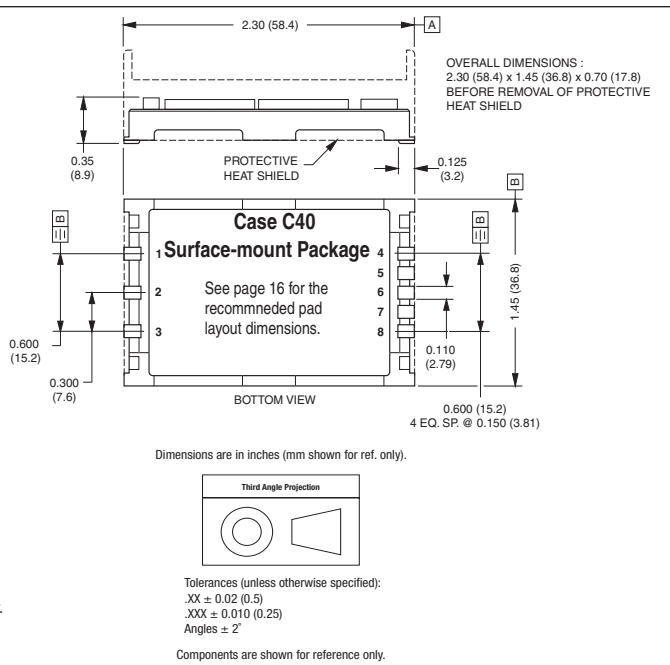
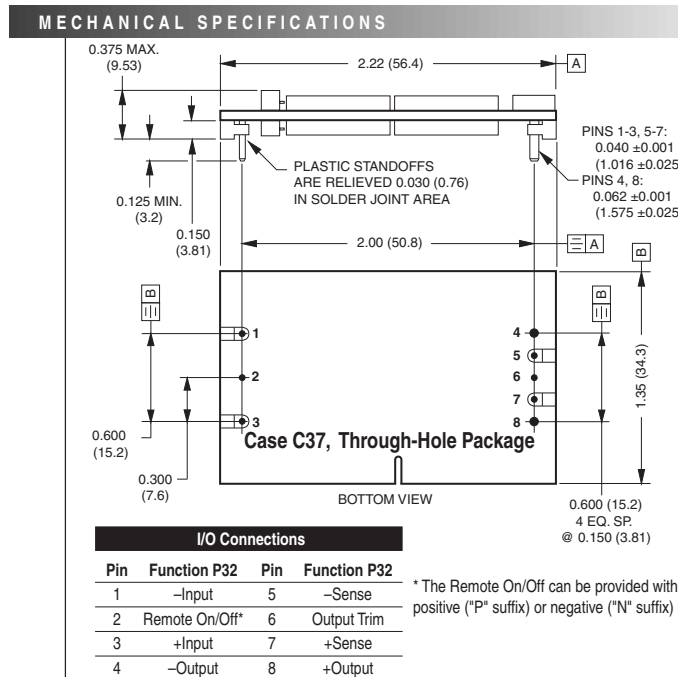
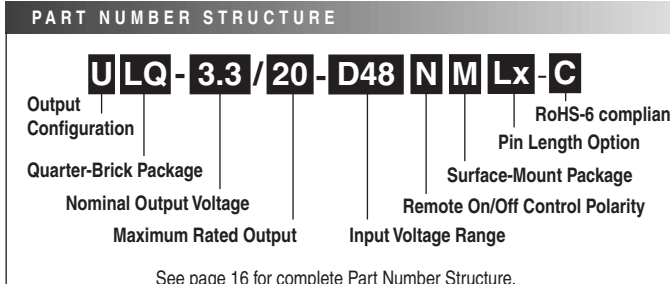

## Single Output, Low-Profile, Quarter-Brick 8-25 Amp Isolated DC/DC Converters

### Performance/Functional Specifications

Typical @ T<sub>A</sub> = +25°C under nominal line voltage, full-load conditions, unless noted. (1)

Input	
<b>Input Voltage Range:</b> (2)	
D24 Models	18-36 Volts (24V nominal)
D48 Models	36-75 Volts (48V nominal)
<b>Overvoltage Shutdown</b>	
D24 Models	37-41 Volts (39V typical)
D48 Models	None (3)
<b>Start-Up Threshold:</b> (4)	
D24 Models	16-18 Volts (17.5V typical)
D48 Models	34-36 Volts (35V typical)
<b>Undervoltage Shutdown:</b> (4)	
D24 Models	15.5-17.5 Volts (16.75V typical)
D48 Models	32.5-34.5 Volts (33.5V typical)
<b>Input Current:</b>	
Normal Operating Conditions	See Ordering Guide
Inrush Transient	0.05A <sup>2</sup> sec maximum
Short Circuit	50-100mA
Standby Mode:	
Off, UV, Thermal Shutdown	4-10mA
<b>Input Reflected Ripple Current</b> (5)	8-50mA <sub>p-p</sub>
<b>Internal Input Filter Type</b>	Pi
<b>Reverse-Polarity Protection</b> (3)	1 minute duration, 5A maximum
<b>Remote On/Off Control</b> (Pin 2): (6)	
Positive Logic ("P" Suffix Models)	On = open, open collector or 3.5-13V applied Off = pulled low to 0-0.8V I <sub>IN</sub> = 6mA max.
Negative Logic ("N" Suffix Models)	On = pulled low to 0-0.8V I <sub>IN</sub> = 6mA max. Off = open, open collector or 3.5-13V applied
Output	
<b>Minimum Loading</b>	No load
<b>V<sub>OUT</sub> Accuracy</b> (Full Load):	
Initial	±1.25% maximum
Temperature Coefficient	±0.02% per °C
Extreme (8)	±3%
<b>V<sub>OUT</sub> Trim Range</b> (9)	+10%, -20%
<b>Remote Sense Compensation</b> (4)	+10%
<b>Ripple/Noise</b> (20MHz BW)	See Ordering Guide
<b>Line/Load Regulation</b>	See Ordering Guide
<b>Efficiency</b>	See Ordering Guide
<b>Isolation Voltage:</b> Input-to-Output	2000Vdc minimum, D24 models 2250Vdc minimum, D48 models
<b>Isolation Resistance</b>	100MΩ
<b>Isolation Capacitance</b>	470pF
<b>Current Limit Inception</b> (98% V <sub>OUT</sub> ) (10)	
After warmup	+125% of maximum rated current
<b>Short Circuit:</b> (4)	
Current	Hiccup with auto-restart
Duration	Continuous
<b>Overvoltage Protection:</b> (4)	V <sub>OUT</sub> nominal +20%
OVP method	Comparator magnetic feedback
Dynamic Characteristics	
<b>Dynamic Load Response</b> (11)	
(50% Load Step)	60-300μsec, model dependent
<b>Start-Up Time:</b> (4) (12)	
V <sub>IN</sub> to V <sub>OUT</sub> ; On/Off to V <sub>OUT</sub>	30msec typical, 50msec maximum
<b>Switching Frequency</b>	160-300kHz, model dependent
<b>Maximum Capacitive Load</b>	4700 to 10,000μF, model dependent

Environmental	
<b>Calculated MTBF:</b> (13)	TBD million hours
<b>Operating Temperature</b> (Ambient): (4) (14)	-40 to +85°C with derating See derating curves
<b>PCB Temperature:</b> (4) (7)	
Maximum Allowable	+100°C
Thermal Shutdown	+105 to 120°C, +115°C typical
Physical	
<b>Dimensions</b>	See Mechanical Dimensions
<b>Pin Material (through-hole)</b>	Gold-plated copper alloy with nickel underplate
<b>Pad Material (SMT)</b>	Copper alloy, pure tin over nickel underplate
<b>Weight:</b>	1 ounce (28 grams)
<b>Primary-to-Secondary Insulation Level</b>	Basic
<b>EMI</b> Conducted and Radiated	FCC Part 15, EN55022 may require external filter
<b>Safety</b>	UL/IEC/EN60950-1 CSA-C22.2 No. 234

- (1) All models are tested and specified with external output capacitors (1μF ceramic in parallel with 10μF tantalum), unless otherwise noted. These converters have no minimum-load requirements and will effectively regulate under no-load conditions.
- (2) Contact Murata Power Solutions for input voltage ranges other than those listed.
- (3) See Absolute Maximum Ratings for allowable input voltages.
- (4) See Technical Notes/Performance Curves for additional explanations and details.
- (5) Input Ripple Current is tested/specified over a 5-20MHz bandwidth with an external 33μF input capacitor and a simulated source impedance of 220μF and 12μH. See I/O Filtering, Input Ripple Current and Output Noise for details.
- (6) The On/Off Control is designed to be driven with open-collector (or equivalent) logic or the application of appropriate voltages (referenced to -Input (pin 1)). See Remote On/Off Control for more details.
- (7) All models are fully operational and meet published specifications, including "cold start," at -40°C.
- (8) Extreme Accuracy refers to the accuracy of either trimmed or untrimmed output voltages over all normal operating ranges and combinations of input voltage, output load and temperature.
- (9) See Output Trimming for detailed trim equations.
- (10) The Current-Limit Inception point is the output current level at which the ULQ's power-limiting circuitry drops the output voltage 2% from its initial value. See Output Current Limiting and Short-Circuit Protection for more details.
- (11) See Performance Curves for additional information.
- (12) For the Start-Up Time specifications, output settling is defined by the output voltage having reached ±1% of its final value.
- (13) MTBF's are calculated using Telcordia (Bellcore) Method 1 Case 3, ground fixed conditions, +40°C case temperature, and full-load conditions.

Absolute Maximum Ratings		
<b>Input Voltage:</b>	<b>D24V Models</b>	<b>D48V Models</b>
Continuous:	See OVP	81 Volts
Transient (100msec):	NA	100 Volts
<b>Input Reverse-Polarity Protection</b>	Input Current must be <5A. 1 minute duration. Fusing recommended.	
<b>Output Current</b>	Current limited. Devices can withstand an indefinite output short circuit.	
<b>On/Off Control (Pin 2) Max. Voltages</b>	Referenced to -Input (pin 1)	
	-0.3 to +13.6 Volts	
<b>Storage Temperature</b>	-55 to +125°C	
<b>Lead Temperature</b>		
Through-hole Soldering	+300°C, 10 seconds	
SMT Soldering	Refer to solder profile	
These are stress ratings. Exposure of devices to any of these conditions may adversely affect long-term reliability. Proper operation under conditions other than those listed in the Performance/Functional Specifications Table is not implied, nor recommended.		

TECHNICAL NOTES

**Input Fusing**

Certain applications and/or safety agencies may require the installation of fuses at the inputs of power conversion components. Fuses should also be used if the possibility of sustained, non-current-limited, input-voltage polarity reversals exists. For DATEL ULQ series DC/DC converters, we recommend the use of a time delay fuse, installed in the ungrounded input supply line, with a value no greater than 20 Amps.

As a rule of thumb however, we recommend the use of a normal-blow or slow-blow fuse with a typical value about twice the maximum input current, calculated at low line with the converter's minimum efficiency.

All relevant national and international safety standards and regulations must be observed by the installer. For system safety agency approvals, the converters must be installed in compliance with the requirements of the end-use safety standard, i.e. IEC/EN/UL60950.

**Input Reverse-Polarity Protection**

If the input voltage polarity is accidentally reversed, an internal diode will become forward biased and likely draw excessive current from the power source. If this source is not current limited or the circuit appropriately fused, it could cause permanent damage to the converter.

**Input Undervoltage Shutdown and Start-Up Threshold**

Under normal start-up conditions, devices will not begin to regulate properly until the ramping-up input voltage exceeds the Start-Up Threshold Voltage. Once operating, devices will not turn off until the input voltage drops below the Undervoltage Shutdown limit. Subsequent re-start will not occur until the input is brought back up to the Start-Up Threshold. This built in hysteresis prevents any unstable on/off situations from occurring at a single input voltage.

**Start-Up Time**

The  $V_{IN}$  to  $V_{OUT}$  Start-Up Time is the time interval between the point at which the ramping input voltage crosses the Start-Up Threshold and the fully loaded output voltage enters and remains within its specified accuracy band. Actual measured times will vary with input source impedance, external input capacitance, and the slew rate and final value of the input voltage as it appears at the converter. The ULQ Series implements a soft start circuit to limit the duty cycle of its PWM controller at power up, thereby limiting the input inrush current.

The On/Off Control to  $V_{OUT}$  start-up time assumes the converter has its nominal input voltage applied but is turned off via the On/Off Control pin. The specification defines the interval between the point at which the converter is turned on (released) and the fully loaded output voltage enters and remains within its specified accuracy band.

Similar to the  $V_{IN}$  to  $V_{OUT}$  start-up, the On/Off Control to  $V_{OUT}$  start-up time is also governed by the internal soft start circuitry and external load capacitance. The difference in start up time from  $V_{IN}$  to  $V_{OUT}$  and from On/Off Control to  $V_{OUT}$  is therefore insignificant.

**Input Overvoltage Shutdown**

All 24V<sub>IN</sub> ULQ DC/DC's are equipped with input overvoltage protection. Input voltages exceeding the input overvoltage shutdown specification listed in the Performance/Functional Specifications will cause the device to shutdown.

**Single Output, Low-Profile, Quarter-Brick 8-25 Amp Isolated DC/DC Converters**

A built-in hysteresis for all models will not allow the converter to restart until the input voltage is sufficiently reduced.

All 48V<sub>IN</sub> models have the overvoltage shutdown function disabled, based on requirements to withstand brief input surges and transients to 100V for up to 100msec without voltage interruption. Contact DATEL to have input overvoltage shutdown for 48V<sub>IN</sub> models enabled.

**Input Source Impedance**

The input of ULQ converters must be driven from a low ac-impedance source. The DC/DC's performance and stability can be compromised by the use of highly inductive source impedances. The input circuit shown in Figure 2 is a practical solution that can be used to minimize the effects of inductance in the input traces. For optimum performance, components should be mounted close to the DC/DC converter.

**I/O Filtering, Input Ripple Current, and Output Noise**

All models in the ULQ Series are tested/specified for input reflected ripple current and output noise using the specified external input/output components/circuits and layout as shown in the following two figures. External input capacitors ( $C_{IN}$  in Figure 2) serve primarily as energy-storage elements, minimizing line voltage variations caused by transient IR drops in conductors from backplane to the DC/DC. Input caps should be selected for bulk capacitance (at appropriate frequencies), low ESR, and high rms-ripple-current ratings. The switching nature of DC/DC converters requires that dc voltage sources have low ac impedance as highly inductive source impedance can affect system stability. In Figure 2,  $C_{BUS}$  and  $L_{BUS}$  simulate a typical dc voltage bus. Your specific system configuration may necessitate additional considerations.

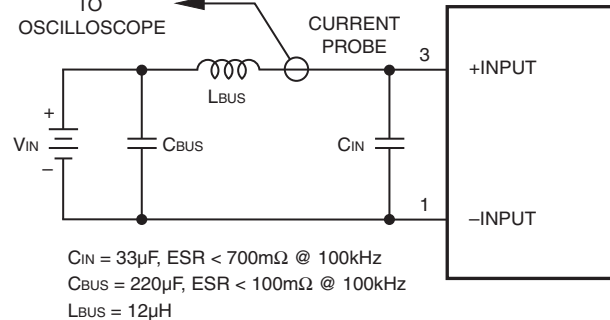

**Figure 2. Measuring Input Ripple Current**

In critical applications, output ripple/noise (also referred to as periodic and random deviations or PARD) may be reduced below specified limits using filtering techniques, the simplest of which is the installation of additional external output capacitors. They function as true filter elements and should be selected for bulk capacitance, low ESR and appropriate frequency response. All external capacitors should have appropriate voltage ratings and be located as close to the converter as possible. Temperature variations for all relevant parameters should also be taken carefully into consideration. The most effective combination of external I/O capacitors will be a function of line voltage and source impedance, as well as particular load and layout conditions. Our Applications Engineers can recommend potential solutions and discuss the possibility of our modifying a given device's internal filtering to meet your specific requirements. Contact our Applications Engineering Group for additional details.



## Single Output, Low-Profile, Quarter-Brick 8-25 Amp Isolated DC/DC Converters

In Figure 3, the two copper strips simulate real-world pcb impedances between the power supply and its load. In order to minimize measurement errors, scope measurements should be made using BNC connectors, or the probe ground should be less than 1/2 inch and soldered directly to the fixture.

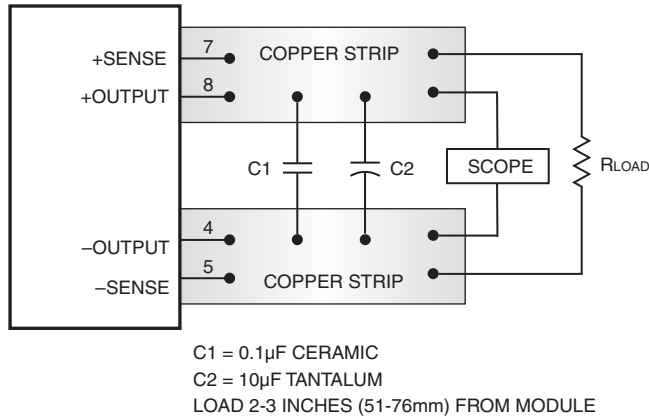

**Figure 3. Measuring Output Ripple/Noise (PARD)**

### Floating Outputs

Since these are isolated DC/DC converters, their outputs are "floating" with respect to their input. Designers will normally use the -Output (pin 4) as the ground/return of the load circuit. You can however, use the +Output (pin 8) as ground/return to effectively reverse the output polarity.

### Minimum Output Loading Requirements

ULQ converters employ a synchronous-rectifier design topology and all models regulate within spec and are stable under no-load to full load conditions. Operation under no-load conditions however might slightly increase the output ripple and noise.

### Thermal Shutdown

The ULQ converters are equipped with thermal-shutdown circuitry. If environmental conditions cause the temperature of the DC/DC converter to rise above the designed operating temperature, a precision temperature sensor will power down the unit. When the internal temperature decreases below the threshold of the temperature sensor, the unit will self start. See Performance/Functional Specifications.

### Output Overvoltage Protection

The ULQ output voltage is monitored for an overvoltage condition using a comparator. The signal is optically coupled to the primary side and if the output voltage rises to a level which could be damaging to the load, the sensing circuitry will power down the PWM controller causing the output voltage to decrease. Following a time-out period the PWM will restart, causing the output voltage to ramp to its appropriate value. If the fault condition persists, and the output voltage again climbs to excessive levels, the overvoltage circuitry will initiate another shutdown cycle. This on/off cycling is referred to as "hiccup" mode.

### Current Limiting

As soon as the output current increases to approximately 130% of its rated value, the DC/DC converter will go into a current-limiting mode. In this condi-

tion, the output voltage will decrease proportionately with increases in output current, thereby maintaining somewhat constant power dissipation. This is commonly referred to as power limiting. Current limit inception is defined as the point at which the full-power output voltage falls below the specified tolerance. See Performance/Functional Specifications. If the load current, being drawn from the converter, is significant enough, the unit will go into a short circuit condition as described below.

### Short Circuit Condition

When a converter is in current-limit mode, the output voltage will drop as the output current demand increases. If the output voltage drops too low, the magnetically coupled voltage used to develop primary side voltages will also drop, thereby shutting down the PWM controller. Following a time-out period, the PWM will restart causing the output voltage to begin ramping to their appropriate value. If the short-circuit condition persists, another shutdown cycle will be initiated. This on/off cycling is referred to as "hiccup" mode. The hiccup cycling reduces the average output current, thereby preventing internal temperatures from rising to excessive levels. The ULQ Series is capable of enduring an indefinite short circuit output condition.

## FEATURES AND OPTIONS

### Remote Sense

Note: The Sense and  $V_{OUT}$  lines are internally connected through low-value resistors. Nevertheless, if the sense function is not used for remote regulation the user should connect the +Sense to + $V_{OUT}$  and -Sense to - $V_{OUT}$  at the DC/DC converter pins.

ULQ series converters employ a sense feature to provide point of use regulation, thereby overcoming moderate IR drops in pcb conductors or cabling. The remote sense lines carry very little current and therefore require minimal cross-sectional-area conductors. The sense lines, which are capacitively coupled to their respective output lines, are used by the feedback control-loop to regulate the output. As such, they are not low impedance points and must be treated with care in layouts and cabling. Sense lines on a pcb should be run adjacent to dc signals, preferably ground. In cables and discrete wiring applications, twisted pair or other techniques should be implemented.

ULQ series converters will compensate for drops between the output voltage at the DC/DC and the sense voltage at the DC/DC provided that:

$$[V_{OUT(+)} - V_{OUT(-)}] - [Sense(+) - Sense(-)] \leq 10\% V_{OUT}$$

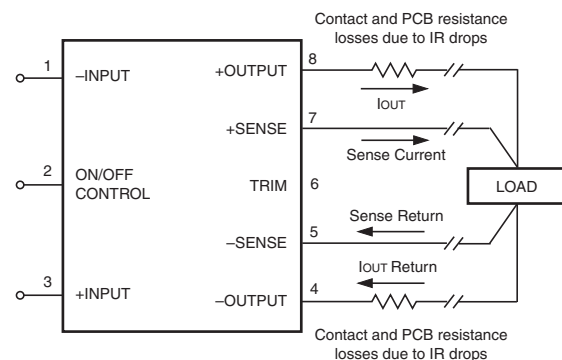

**Figure 4. Remote Sense Circuit Configuration**

## Single Output, Low-Profile, Quarter-Brick 8-25 Amp Isolated DC/DC Converters

Output overvoltage protection is monitored at the output voltage pin, not the Sense pin. Therefore, excessive voltage differences between  $V_{OUT}$  and Sense in conjunction with trim adjustment of the output voltage can cause the overvoltage protection circuitry to activate (see Performance Specifications for overvoltage limits). Power derating is based on maximum output current and voltage at the converter's output pins. Use of trim and sense functions can cause output voltages to increase, thereby increasing output power beyond the converter's specified rating, or cause output voltages to climb into the output overvoltage region. Therefore, the designer must ensure:

$$(V_{OUT \text{ at pins}}) \times (I_{OUT}) \leq \text{rated output power}$$

### Trimming Output Voltage

ULQ converters have a trim capability (pin 6) that enables users to adjust the output voltage from +10% to -20% (refer to the trim equations and trim graphs that follow). Adjustments to the output voltage can be accomplished via a trim pot (Figure 5) or a single fixed resistor as shown in Figures 6 and 7. A single fixed resistor can increase or decrease the output voltage depending on its connection. Resistors should be located close to the converter and have TCR's less than 100ppm/°C to minimize sensitivity to changes in temperature. If the trim function is not used, leave the trim pin open.

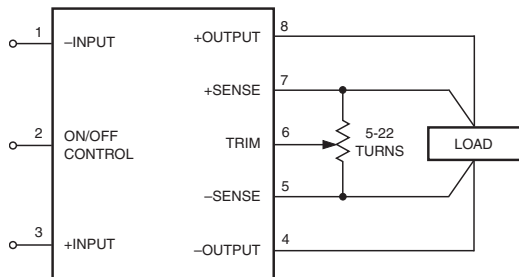

Figure 5. Trim Connections Using A Trimpot

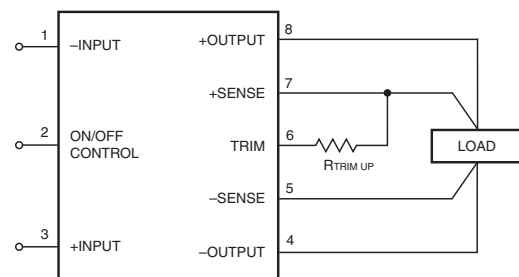

Figure 6. Trim Connections To Increase Output Voltages Using Fixed Resistors

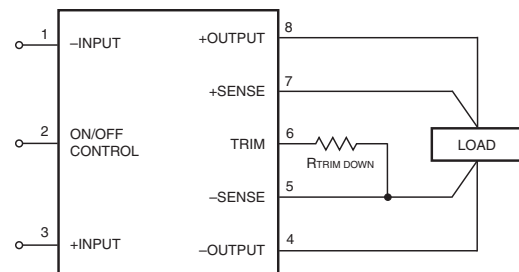

Figure 7. Trim Connections To Decrease Output Voltages Using Fixed Resistors

A single resistor connected from the Trim pin (pin 6) to the +Sense (pin 7) will increase the output voltage. A resistor connected from the Trim Pin (pin 6) to the -Sense (pin 5) will decrease the output voltage.

Trim adjustments greater than the specified +10%/–20% can have an adverse affect on the converter's performance and are not recommended. Excessive voltage differences between  $V_{OUT}$  and Sense, in conjunction with trim adjustment of the output voltage, can cause the overvoltage protection circuitry to activate (see Performance Specifications for overvoltage limits).

Temperature/power derating is based on maximum output current and voltage at the converter's output pins. Use of the trim and sense functions can cause output voltages to increase, thereby increasing output power beyond the converter's specified rating, or cause output voltages to climb into the output overvoltage region. Therefore:

$$(V_{OUT \text{ at pins}}) \times (I_{OUT}) \leq \text{rated output power}$$

The Trim pin (pin 6) is a relatively high impedance node that can be susceptible to noise pickup when connected to long conductors in noisy environments. In such cases, a 0.22µF capacitor can be added to reduce this long lead effect.

### Trim Equations

ULQ-1.2/15-D48 & ULQ-1.2/25-D48	
$R_{T \text{ UP}} (k\Omega) = \frac{1.308(V_O - 0.793)}{V_O - 1.2} - 1.413$	$R_{T \text{ DOWN}} (k\Omega) = \frac{1.037}{1.2 - V_O} - 1.413$
ULQ-1.5/15-D48, ULQ-1.5/25-D24 & D48	
$R_{T \text{ UP}} (k\Omega) = \frac{6.23(V_O - 1.226)}{V_O - 1.5} - 10.2$	$R_{T \text{ DOWN}} (k\Omega) = \frac{7.64}{1.5 - V_O} - 10.2$
ULQ-1.8/15-D48, ULQ-1.8/25-D24 & D48	
$R_{T \text{ UP}} (k\Omega) = \frac{7.44(V_O - 1.226)}{V_O - 1.8} - 10.2$	$R_{T \text{ DOWN}} (k\Omega) = \frac{9.12}{1.8 - V_O} - 10.2$
ULQ-2/15-D48, ULQ-2/15-D24 & D48	
$R_{T \text{ UP}} (k\Omega) = \frac{8.28(V_O - 1.226)}{V_O - 2} - 10.2$	$R_{T \text{ DOWN}} (k\Omega) = \frac{10.15}{2 - V_O} - 10.2$
ULQ-2.5/15-D48, ULQ-2.5/20-D24 & D48	
$R_{T \text{ UP}} (k\Omega) = \frac{10(V_O - 1.226)}{V_O - 2.5} - 10.2$	$R_{T \text{ DOWN}} (k\Omega) = \frac{12.26}{2.5 - V_O} - 10.2$
ULQ-3.3/15-D48, ULQ-3.3/20-D24 & D48	
$R_{T \text{ UP}} (k\Omega) = \frac{13.3(V_O - 1.226)}{V_O - 3.3} - 10.2$	$R_{T \text{ DOWN}} (k\Omega) = \frac{16.31}{3.3 - V_O} - 10.2$
ULQ-5/15-D24, -D48	
$R_{T \text{ UP}} (k\Omega) = \frac{20.4(V_O - 1.226)}{V_O - 5} - 10.2$	$R_{T \text{ DOWN}} (k\Omega) = \frac{25.01}{5 - V_O} - 10.2$
ULQ-12/8-D24, ULQ-12/10-D48	
$R_{T \text{ UP}} (k\Omega) = \frac{49.6(V_O - 1.226)}{V_O - 12} - 10.2$	$R_{T \text{ DOWN}} (k\Omega) = \frac{60.45}{12 - V_O} - 10.2$

Note: Resistor values are in kΩ. Adjustment accuracy is subject to resistor tolerances and factory-adjusted output accuracy.  $V_O$  = desired output voltage.

## Trim-Up Resistance vs. Percentage Increase in Output Voltage

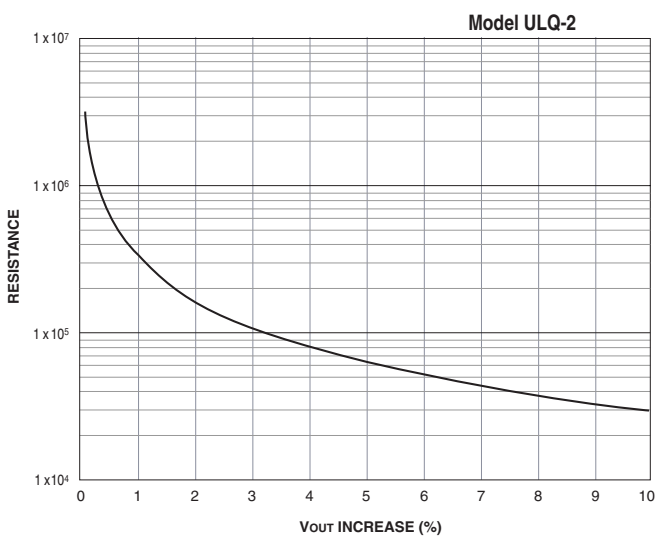
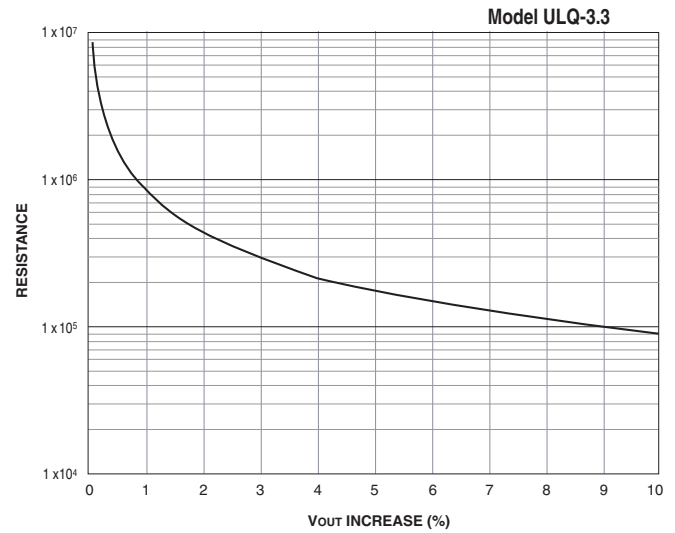
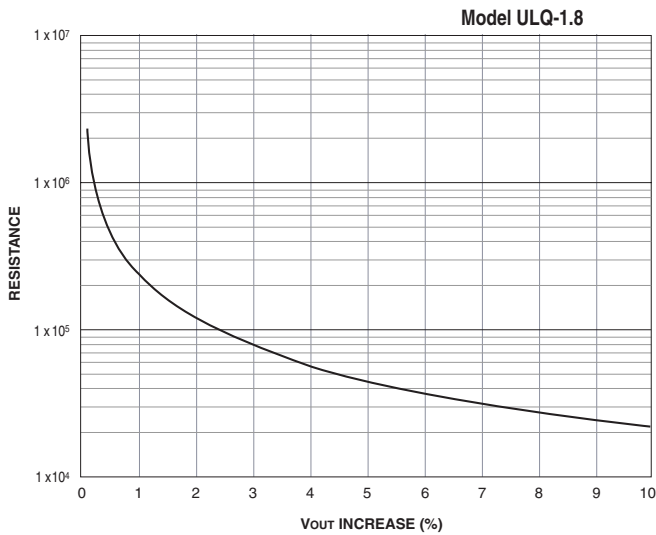
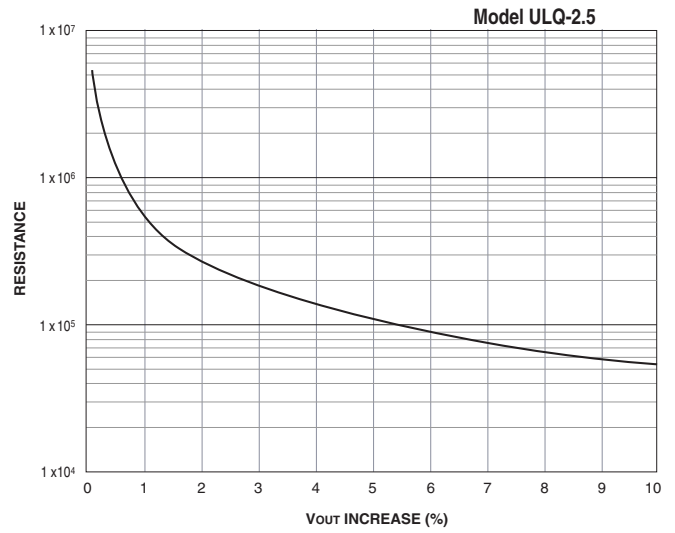
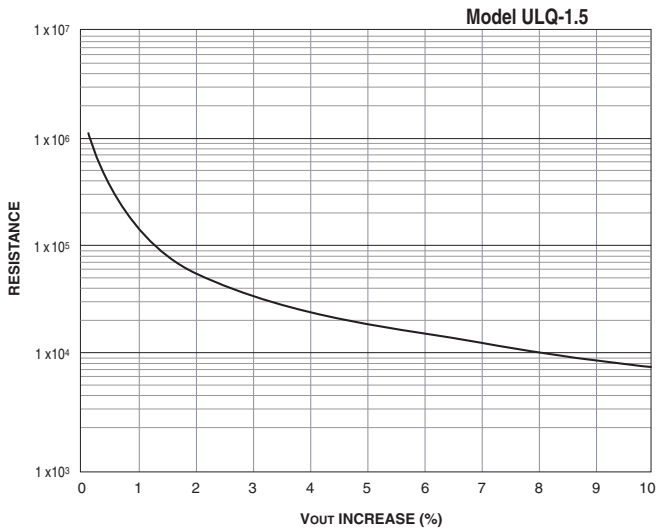

## Trim-Down Resistance vs. Percentage Decrease in Output Voltage

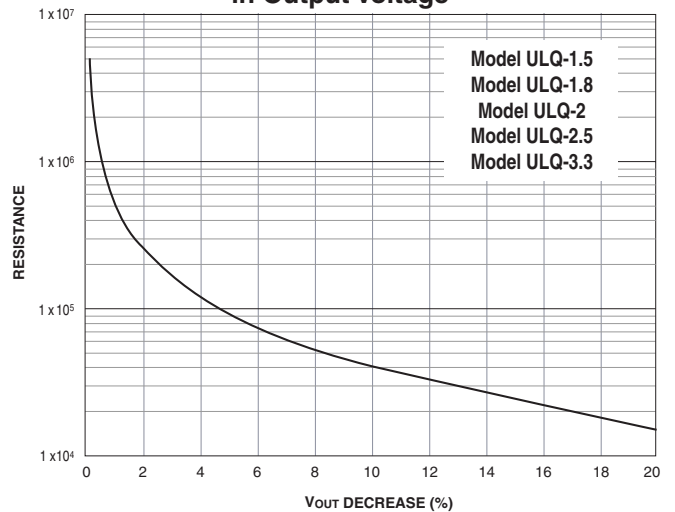

## Single Output, Low-Profile, Quarter-Brick 8-25 Amp Isolated DC/DC Converters

### On/Off Control ("P" or "N" suffix)

The input-side, remote On/Off Control function (pin 2) can be ordered to operate with either polarity:

**"P" suffix:** Standard models are equipped with Positive-polarity and these devices are enabled when pin 2 is left open (or is pulled high, applying +3.5V to +13 with respect to -Input, pin 1) as per Figure 8. Positive-polarity devices are disabled when pin 2 is pulled low (0 to 0.8V with respect to -Input).

**"N" suffix:** Optional Negative-polarity devices are off when pin 2 is left open (or pulled high, applying +3.5V to +13V), and on when pin 2 is pulled low (0 to 0.8V) with respect to -Input as shown in Figure 9.

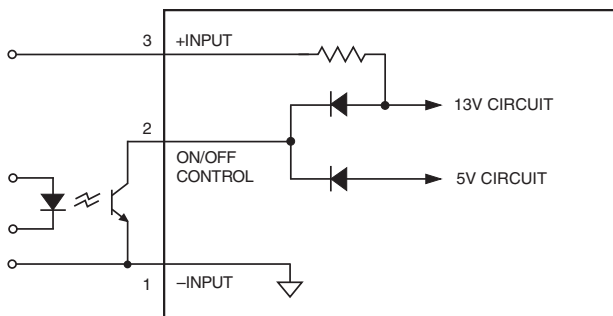

Figure 8. Driving the Positive Polarity On/Off Control Pin

### Surface-Mount Package ("M" suffix)

DATEL's ULQ series SMT DC/DC converters are the only higher-power (to 66W) DC/DC's that can be automatically "pick-and-placed" using standard vacuum-pickup equipment and subsequently reflowed using high-temperature, lead-free solder.

Virtually all SMT DC/DC's today are unprotected "open-frame" devices assembled by their vendors with high-temperature solder (usually Sn96.5/Ag3.5 with a melting point +221°C) so that you may attach them to your board using low-temperature solder (usually Sn63/Pb37 with a melting point of +183°C). Conceptually straightforward, this "stepped" solder approach has its limitations . . . and is clearly out of step with an industry trending toward the broad use of lead-free solders. No need to experiment and develop reflow profiles that ensure the components on their DC/DC never exceed 215-216°C. If those components get too hot, "double-reflow" could compromise the reliability of their solder joints. Virtually all these devices demand you "cool down" the Sn63 profile you are likely using today.

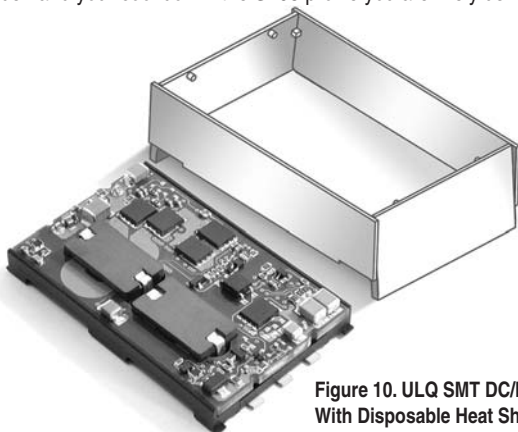

Figure 10. ULQ SMT DC/DC With Disposable Heat Shield

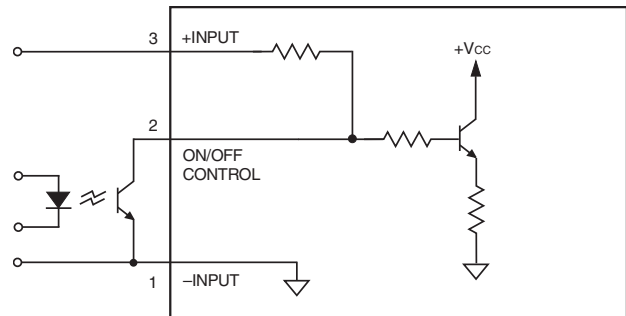

Figure 9. Driving the Negative Polarity On/Off Control Pin

Dynamic control of the remote on/off function is best accomplished with a mechanical relay or an open-collector/open-drain drive circuit (optically isolated if appropriate). The drive circuit should be able to sink appropriate current (see Performance Specifications) when activated and withstand appropriate voltage when deactivated. Applying an external voltage to pin 2 when no input power is applied to the converter can cause permanent damage to the converter.

DATEL is not exempted from the Laws of Physics. And we do not have magic solders no one else has. Nevertheless, we have a simple and practical, straightforward approach that works. We assemble our SMT DC/DC's on a high-temperature, plastic lead-frame (nylon 46, UL94V-0 rated) using a high-temperature (+216°C), lead-free alloy (Sn96.2%, Ag2.5%, Cu0.8%, Sb0.5%). The lead-frame ensures coplanarity (to within 0.004 in.) of the unit's tin-plated (150 microinches) copper leads and also supports a removable heat shield.

The disposable heat shield, which has a cutaway exposing the package leads, provides thermal insulation to internal components during reflow and also doubles as the vacuum pick-up location. The insulation properties of the heat shield are so effective that temperature differentials as high as 50°C develop inside-to-outside the shield. Oven temperature profiles with peaks of 250-260°C and dwell times exceeding 2 minutes above 221°C (the melting point of Sn96.5/Ag3.5) are easily achieved. DATEL's new-generation SMT units are shipped in stackable, JEDEC-style plastic.

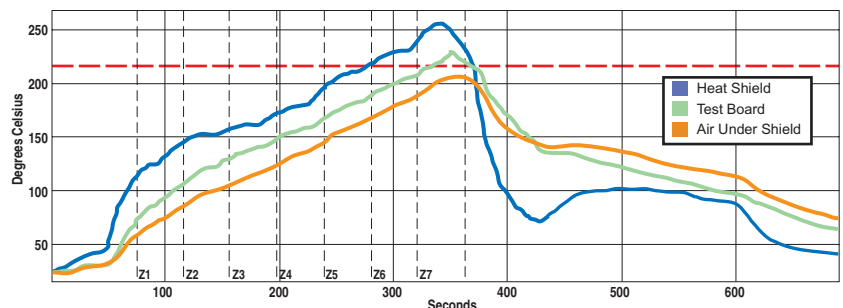
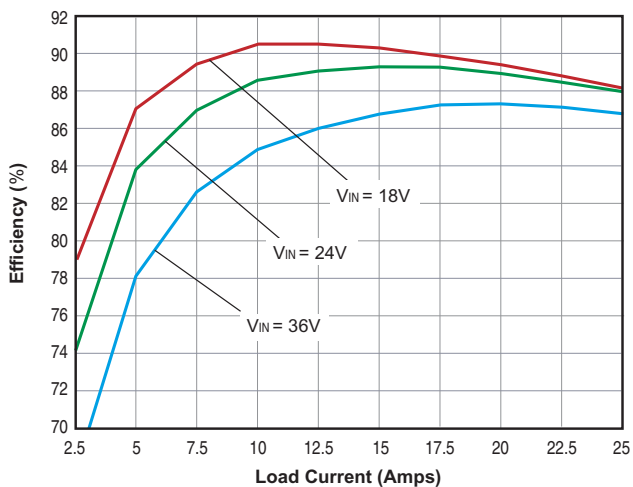

Figure 11. Recommended Solder Profile  
(When The Heat-shield Temperature Exceeds +250°C, The Air Within Is 50°C Cooler)



## Typical Performance Curves, 1.5V Models

**ULQ-1.5/25-D24 Efficiency vs. Line Voltage and Load Current**



**ULQ-1.5/25-D24 Output Current vs. Ambient Temperature (No air flow)**

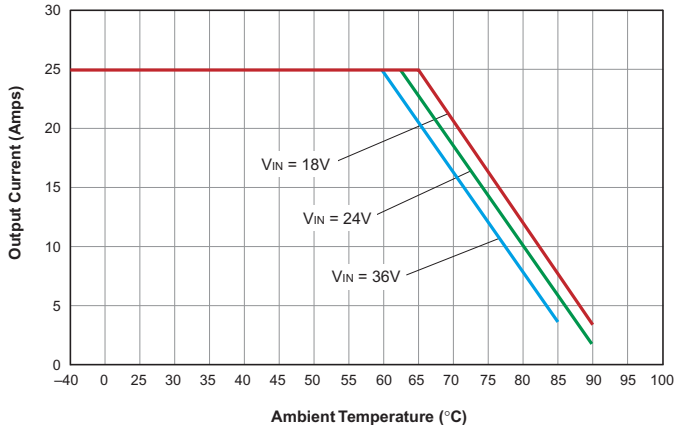

**ULQ-1.5/15-D48 Efficiency vs. Line Voltage and Load Current**

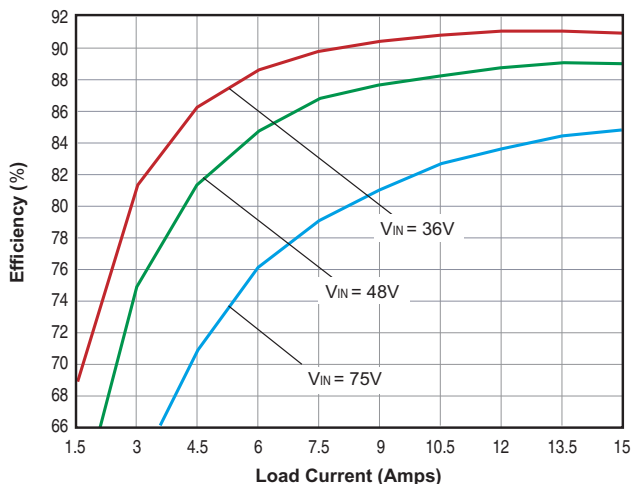

**ULQ-1.5/15-D48 Output Current vs. Ambient Temperature (No air flow)**

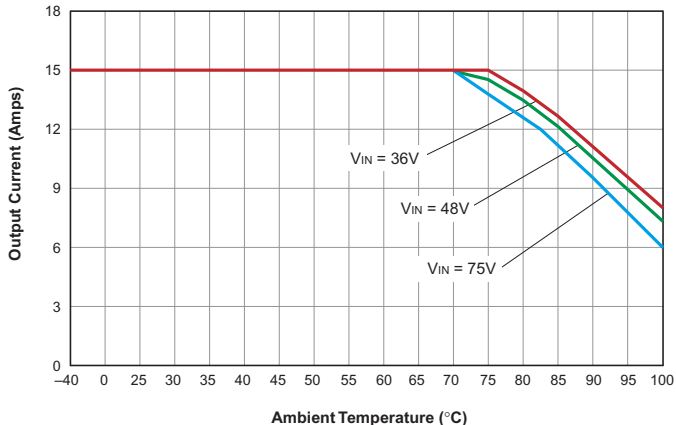

**ULQ-1.5/25-D48 Efficiency vs. Line Voltage and Load Current**

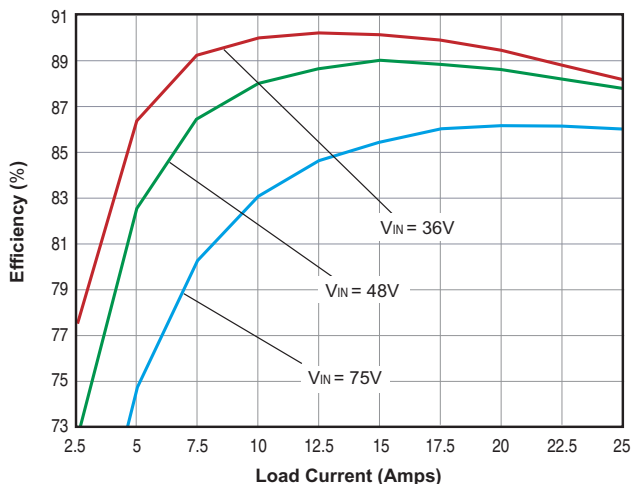

**ULQ-1.5/25-D48 Output Current vs. Ambient Temperature ( $V_{IN} = 48V$ , air flow direction from Input pin to Output pin)**

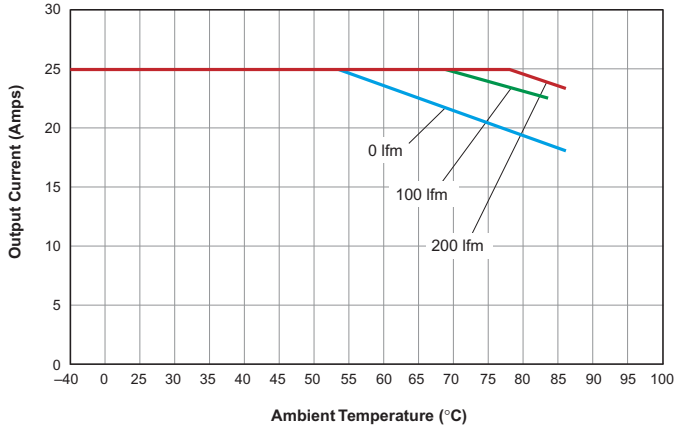

## Typical Performance Curves, 1.8V Models

**ULQ-1.8/15-D48 Efficiency vs. Line Voltage and Load Current**

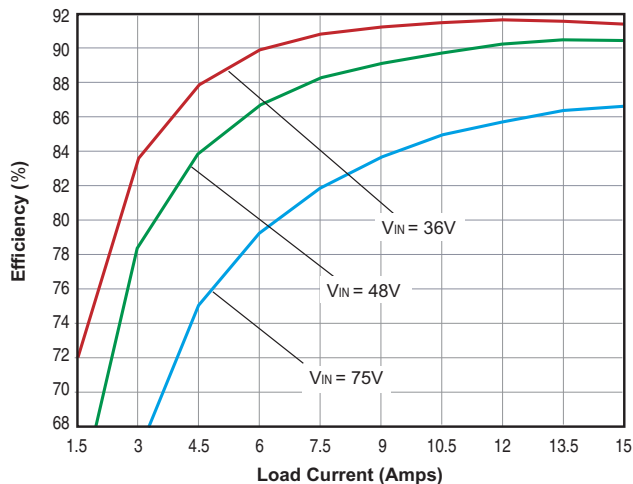

**ULQ-1.8/15-D48 Output Current vs. Ambient Temperature (No air flow)**

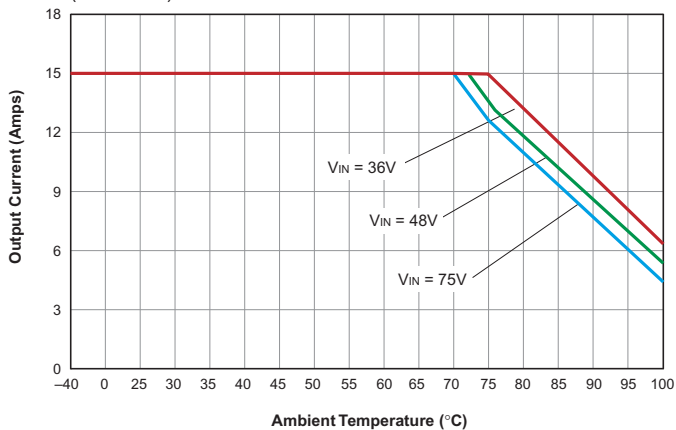

**ULQ-1.8/25-D24 Efficiency vs. Line Voltage and Load Current**

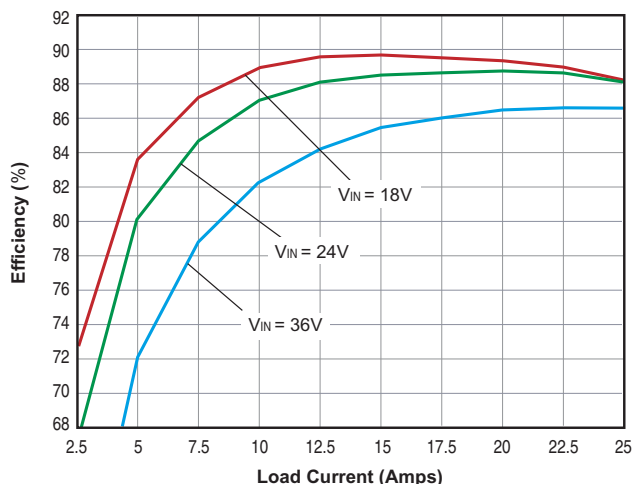

**ULQ-1.8/25-D24 Output Current vs. Ambient Temperature (No air flow)**

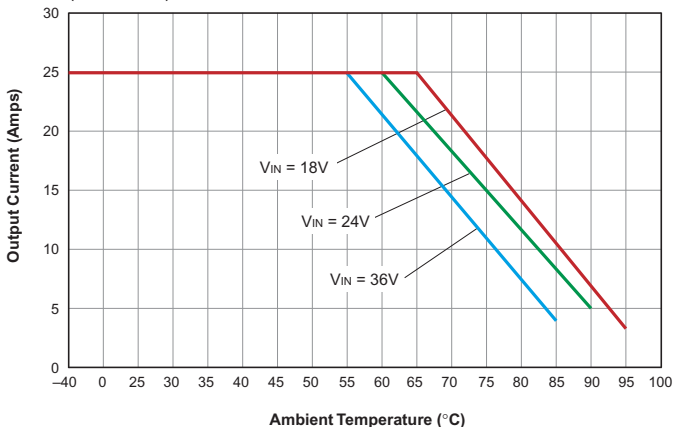

**ULQ-1.8/25-D48 Efficiency vs. Line Voltage and Load Current**

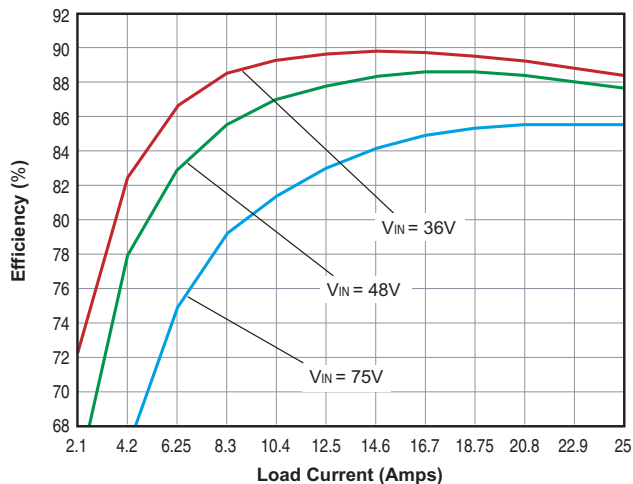

**ULQ-1.8/25-D48 Output Current vs. Ambient Temperature (VIN = 48V, air flow direction from Input pin to Output pin)**

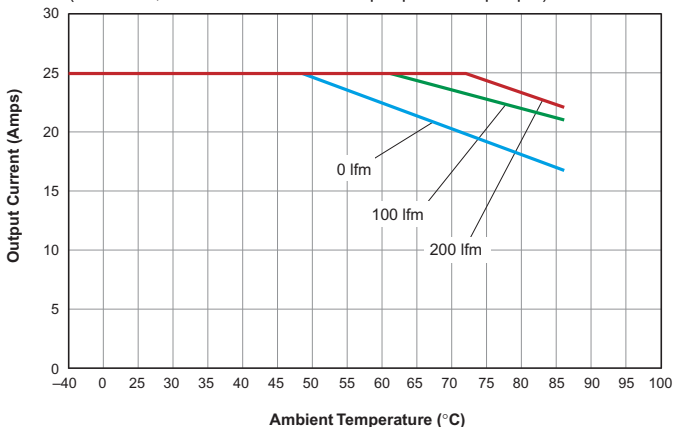

## Typical Performance Curves, 2V Models

**ULQ-2/15-D48 Efficiency vs. Line Voltage and Load Current**

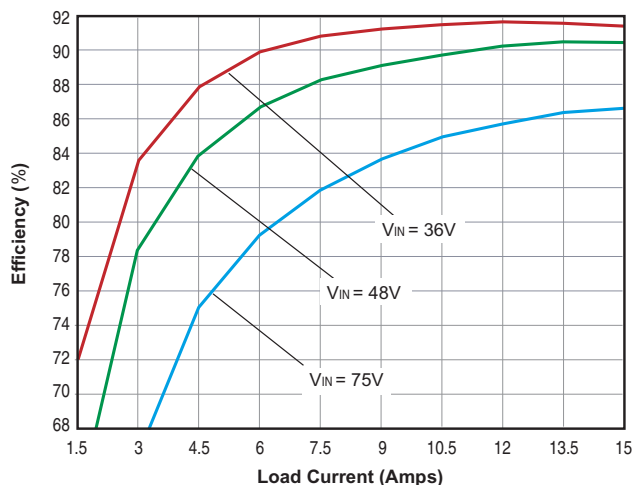

**ULQ-2/15-D48 Output Current vs. Ambient Temperature (No air flow)**

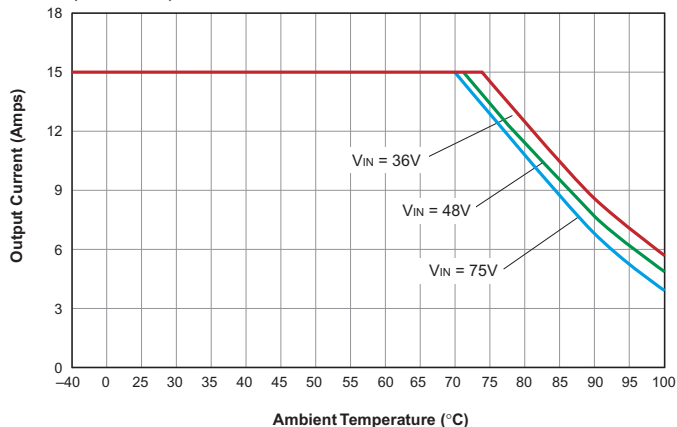

**ULQ-2/25-D24 Efficiency vs. Line Voltage and Load Current**

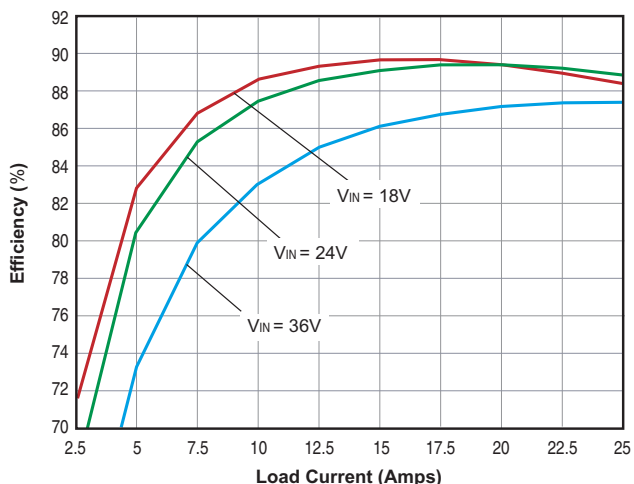

**ULQ-2/25-D24 Output Current vs. Ambient Temperature (No air flow)**

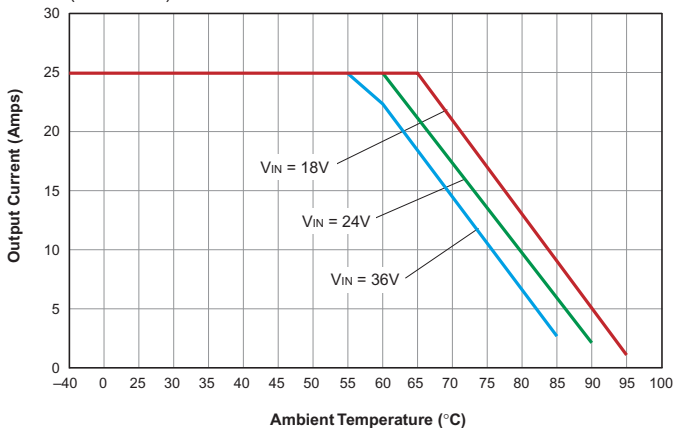

**ULQ-2/25-D48 Efficiency vs. Line Voltage and Load Current**

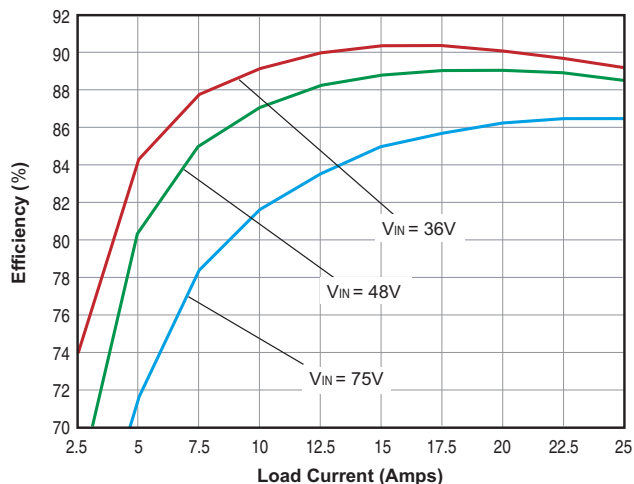

**ULQ-2/25-D48 Output Current vs. Ambient Temperature (VIN = 48V, air flow direction from Input pin to Output pin)**

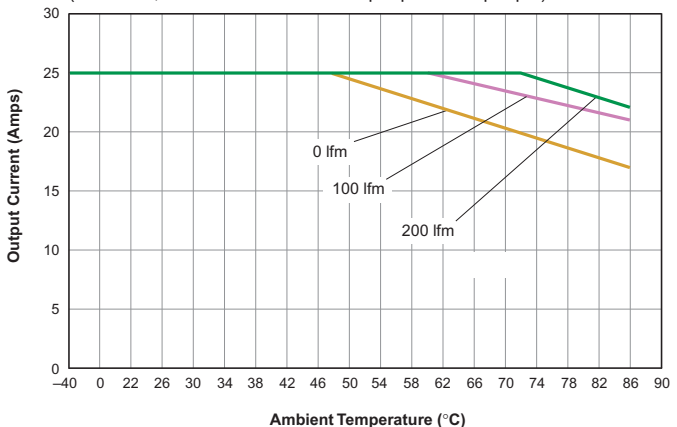

## Typical Performance Curves, 2.5V Models

**ULQ-2.5/15-D48 Efficiency vs. Line Voltage and Load Current**

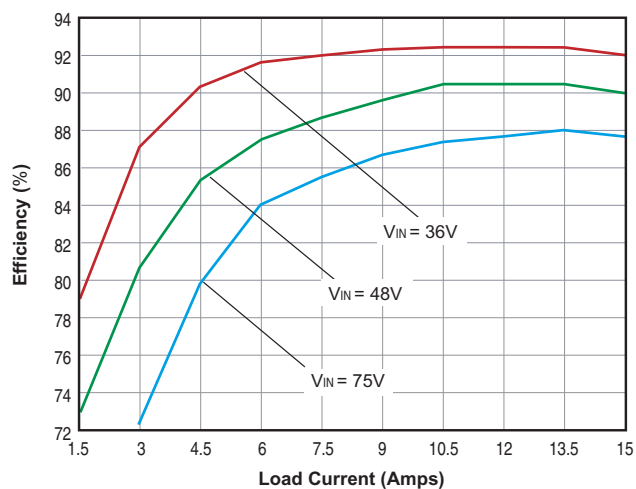

**ULQ-2.5/15-D48**

**Output Current vs. Ambient Temperature**

( $V_{IN} = 48V$ , air flow direction from Input pin to Output pin)

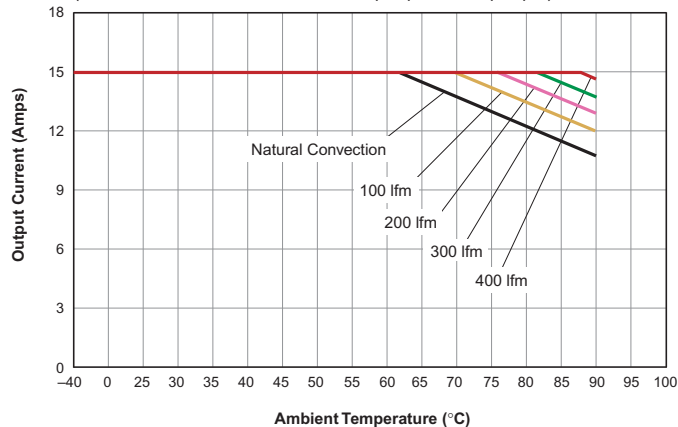

**ULQ-2.5/20-D48 Efficiency vs. Line Voltage and Load Current**

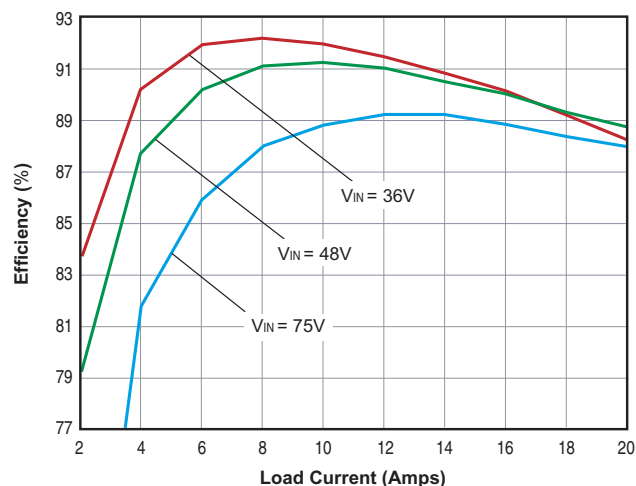

**ULQ-2.5/20-D48**

**Output Current vs. Ambient Temperature**

( $V_{IN} = 48V$ , air flow direction from Input pin to Output pin)

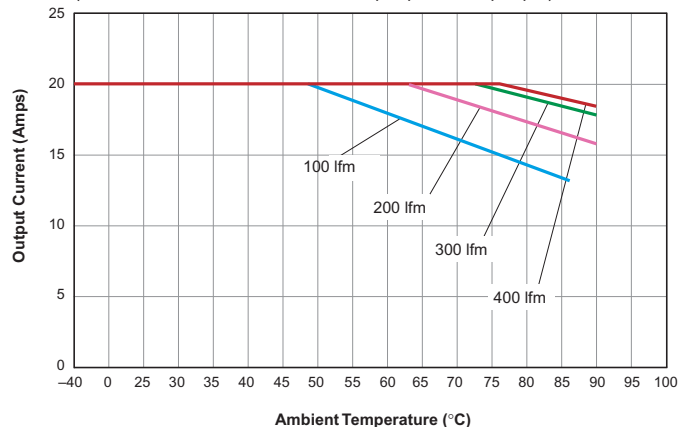

**ULQ-2.5/20-D24 Power Dissipation vs. Load Current**

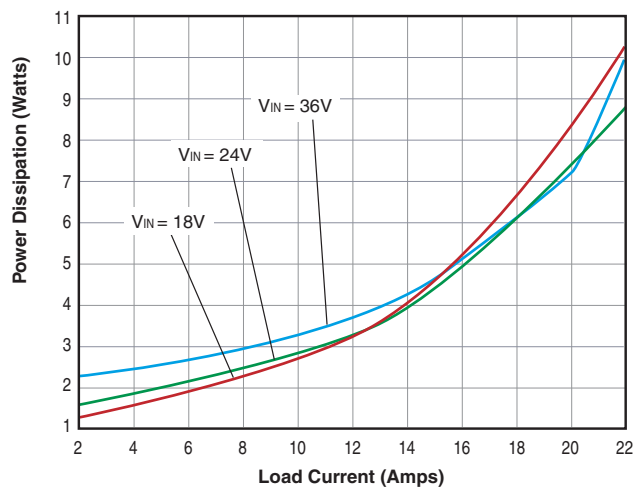

## Typical Performance Curves, 3.3V Models

**ULQ-3.3/15-D48 Efficiency vs. Line Voltage and Load Current**

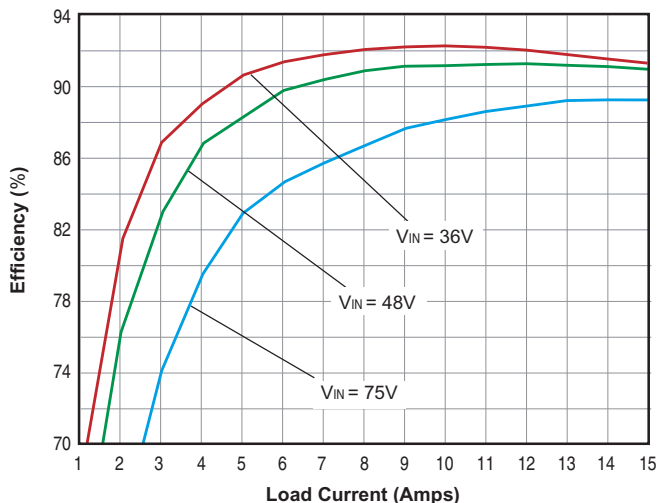

**ULQ-3.3/20-D24 Efficiency vs. Line Voltage and Load Current**

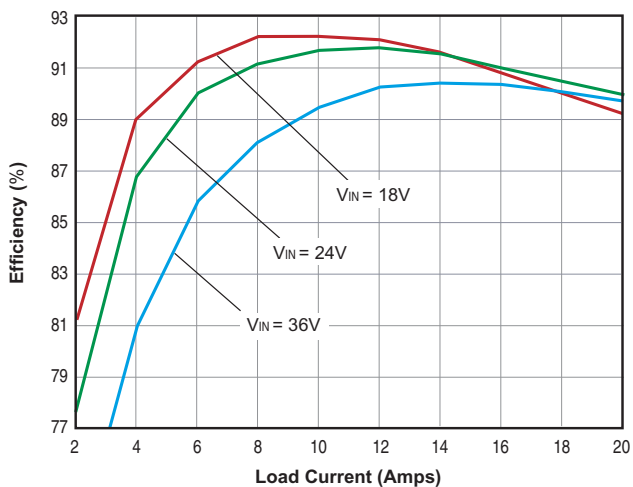

**ULQ-3.3/20-D48 Efficiency vs. Line Voltage and Load Current**

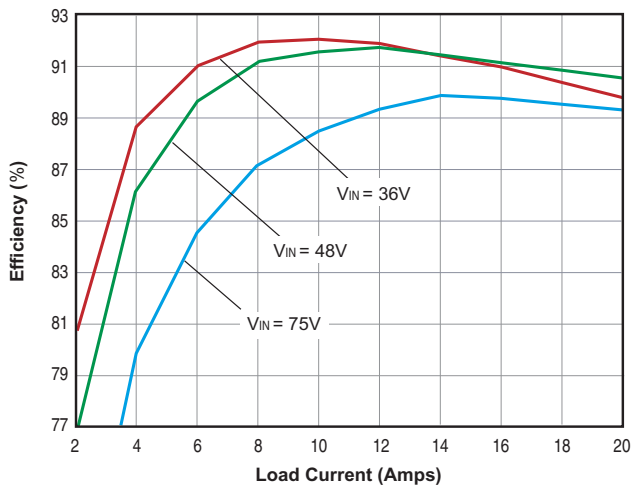

**ULQ-3.3/15-D48**

**Output Current vs. Ambient Temperature**

( $V_{IN} = 48V$ , air flow direction from Input pin to Output pin)

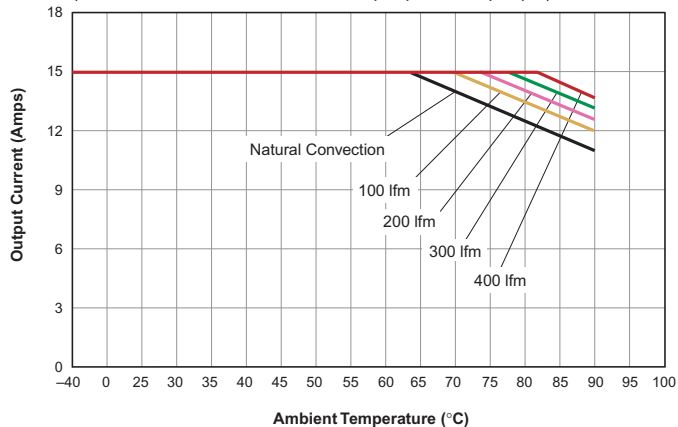

**ULQ-3.3/20-D24**

**Output Current vs. Ambient Temperature**

( $V_{IN} = 24V$ , air flow direction from Input pin to Output pin)

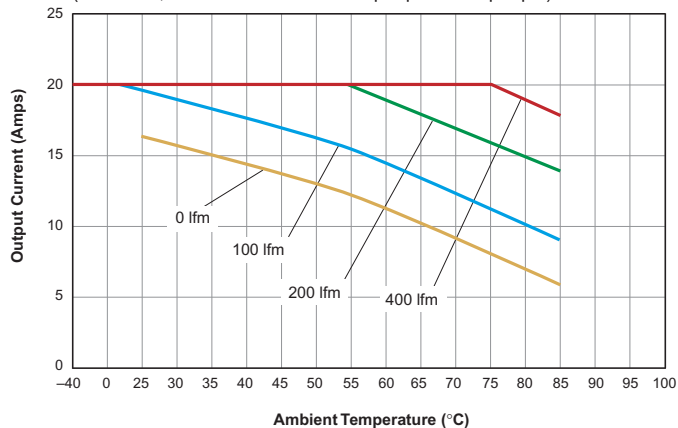

**ULQ-3.3/20-D48**

**Output Current vs. Ambient Temperature**

( $V_{IN} = 48V$ , air flow direction from Input pin to Output pin)

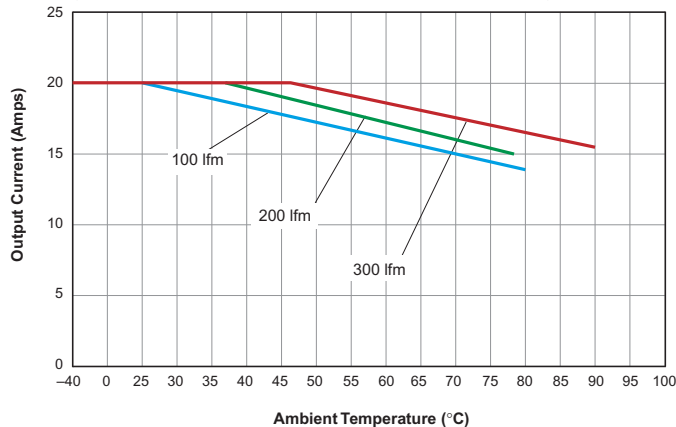



## Typical Performance Curves, 5V Models

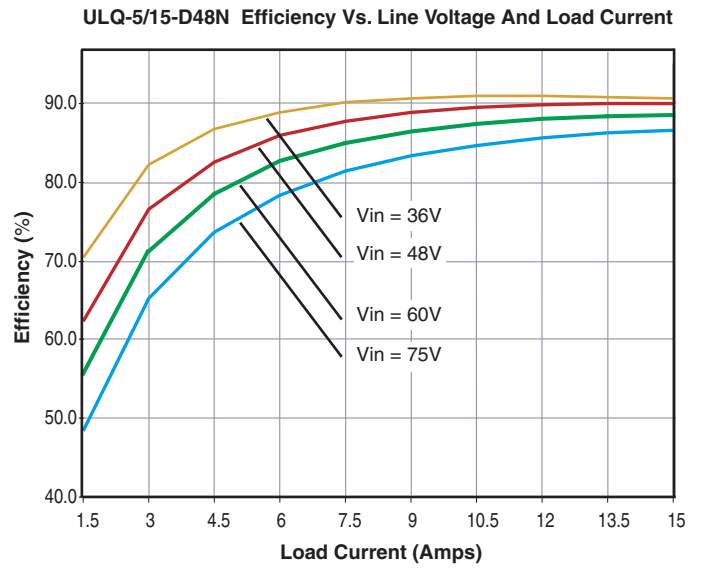
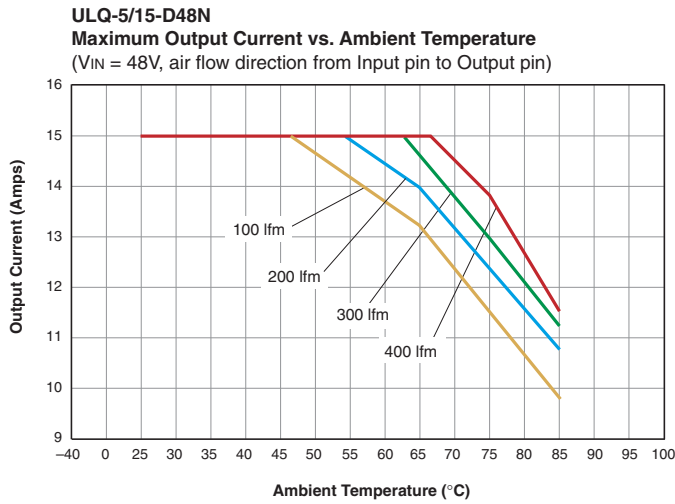

## Typical Performance Curves, 12V Models

**ULQ-12/8-D24N**  
Efficiency vs. Line Voltage and Load Current @25°C

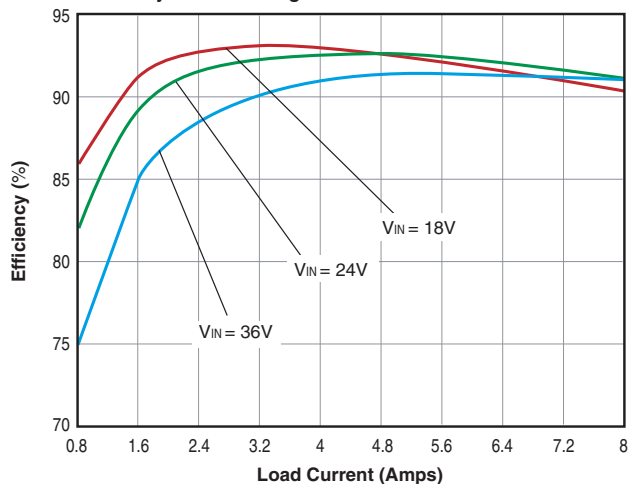

**ULQ-12/8-D24**  
Maximum Output Current vs. Ambient Temperature  
(VIN = 24V, transverse air flow direction from -Output to +Output pin)

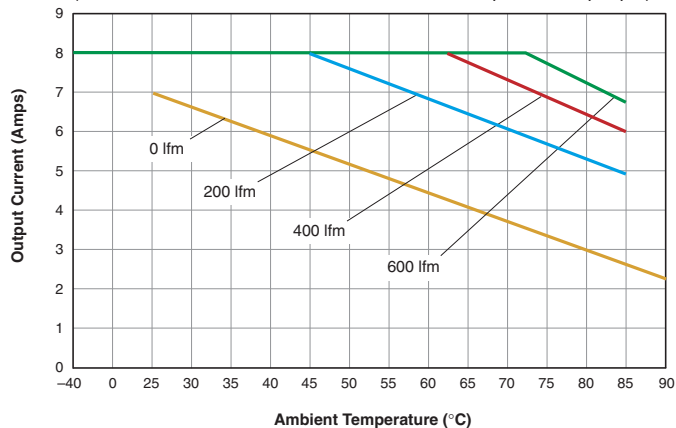

**ULQ-12/10-D48N**  
Efficiency vs. Line Voltage and Load Current @25°C

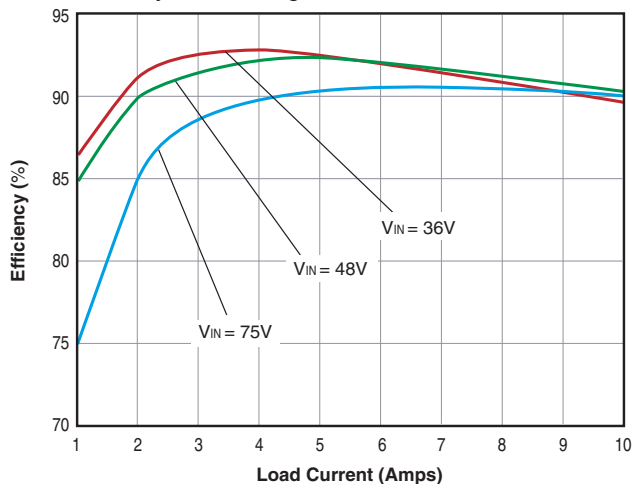

**ULQ-12/10-D48**  
Output Current vs. Ambient Temperature  
(VIN = 48V, air flow direction from Input pin to Output pin)

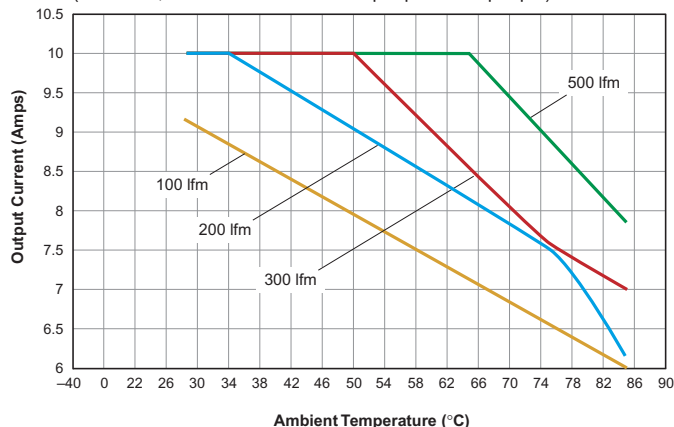

**ULQ-12/10-D48 Power Dissipation vs. Load Current**

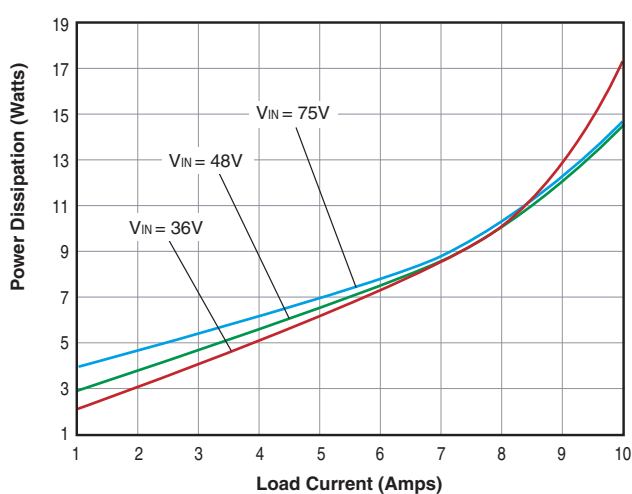

**Single Output, Low-Profile, Quarter-Brick  
8-25 Amp Isolated DC/DC Converters**

For the surface mount versions of the ULQ, use the Recommended SMT Pad Layout illustration as a starting point to locate pads to mount the converter. This diagram is for the pads on the mating printed circuit board—it is *not* the dimensions of the lead terminals on the converter. Note: the pads are slightly larger than the lead terminals to accommodate solder wetting and meniscus. Also, your particular application may require some deviation from this diagram.

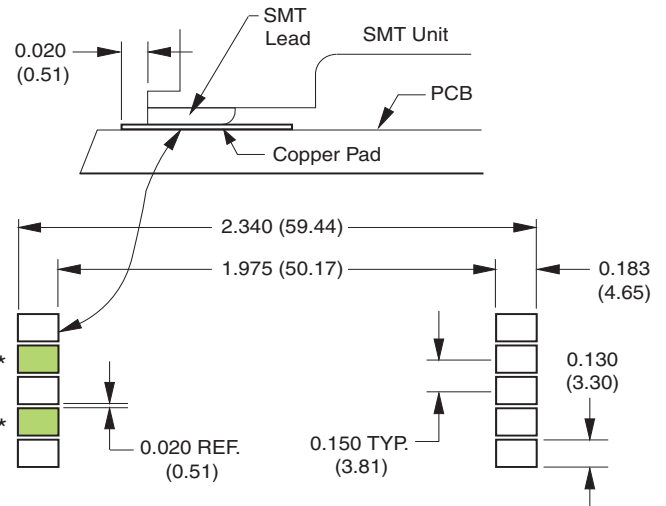

\* These two pads are for alignment and positioning only. They are not required for electrical contact.

**Recommended SMT Pad Layout**

**PART NUMBER STRUCTURE**

**U LQ - 3.3 / 20 - D48 N M Lx - C**

**Output Configuration:**  
U = Unipolar

**Quarter-Brick Package**

**Nominal Output Voltage:**  
1.2, 1.5, 1.8, 2, 2.5, 3.3, 5, 12 Volts

**Maximum Rated Output :**  
Current in Amps

**Input Voltage Range:**  
D24 = 18-36 Volts (24V nominal)  
D48 = 36-75 Volts (48V nominal)

**RoHS-6 Hazardous Substance Compliant**

**Pin Length Option: Through-hole packages only**  
L1 Pin length 0.110 ±0.010 inches (2.79 ±0.25mm)  
L2 Pin length 0.145 ±0.010 inches (3.68 ±0.25mm)  
Blank is standard pin length

**Surface-Mount Package**

**Remote On/Off Control Polarity**  
Add "P" for positive polarity (pin 2 open = converter on)  
Add "N" for negative polarity (pin 2 open = converter off)  
Positive polarity is standard for D24 models.  
Negative polarity is standard for D48 models.  
Alternate polarities may require a special order.

Note: Standard pin length with no "Lx" suffix is 0.125" (3.18mm). The L1 and L2 lengths require a scheduled quantity order.

**Note:**  
Some model number combinations may not be available. Contact Murata Power Solutions.

Murata Power Solutions, Inc.  
11 Cabot Boulevard, Mansfield, MA 02048-1151 U.S.A.  
Tel: (508) 339-3000 (800) 233-2765 Fax: (508) 339-6356  
**www.murata-ps.com email: sales@murata-ps.com ISO 9001 REGISTERED**

Murata Power Solutions, Inc. makes no representation that the use of its products in the circuits described herein, or the use of other technical information contained herein, will not infringe upon existing or future patent rights. The descriptions contained herein do not imply the granting of licenses to make, use, or sell equipment constructed in accordance therewith. Specifications are subject to change without notice. © 2008 Murata Power Solutions, Inc.

05/27/08

- USA:** Mansfield (MA), Tel: (508) 339-3000, email: sales@murata-ps.com
- Canada:** Toronto, Tel: (866) 740-1232, email: toronto@murata-ps.com
- UK:** Milton Keynes, Tel: +44 (0)1908 615232, email: mk@murata-ps.com
- France:** Montigny Le Bretonneux, Tel: +33 (0)1 34 60 01 01, email: france@murata-ps.com
- Germany:** München, Tel: +49 (0)89-544334-0, email: munich@murata-ps.com
- Japan:** Tokyo, Tel: 3-3779-1031, email: sales\_tokyo@murata-ps.com  
Osaka, Tel: 6-6354-2025, email: sales\_osaka@murata-ps.com  
**Website: www.murata-ps.jp**
- China:** Shanghai, Tel: +86 215 027 3678, email: shanghai@murata-ps.com  
Guangzhou, Tel: +86 208 221 8066, email: guangzhou@murata-ps.com