

Dual LDO Voltage Regulator with "GreenOperation"

■ GENERAL DESCRIPTION

☆GreenOperation Compatible

The XC6416 series is a high accurate, low noise, high ripple rejection, and low dropout CMOS Dual regulator with GreenOperation function. The series includes a reference voltage source, an error amplifier, a current limiter, and a phase compensation circuit.

GreenOperation function provides high speed operation, low power consumption and high efficiencies by automatically switching between a high speed mode (HS) and a power save mode (PS) depending on the load current level. The switching point of the GreenOperation to the output current is being fixed inside the IC, thus providing operating conditions with the most suitable level of supply current for the application. The USP-6C package has GO pin. If a high level signal is input to the GO pin, the XC6416 can be used as a high speed fixed mode regulator.

The EN function turns each output of the two regulators independently. In this state, the electric charge at the output capacitor (C_L) is discharged via the internal auto-discharge switch, and as a result the V_{OUT} voltage quickly returns to the V_{SS} level. The output stabilization capacitor (C_L) is also compatible with low ESR ceramic capacitors. Output voltage is selectable in 0.05V increments within a range of 0.8V ~4.0V, using laser trimming technologies. The series includes a fold-back circuit, which aids the operation of the current limiter and circuit protection.

■ APPLICATIONS

- Mobile phones
- Cordless phones, wireless communication equipment
- Portable games
- Cameras, video recorders
- Portable audio equipment
- PDAs

■ FEATURES

Maximum Output Current	: 200mA (300mA limit, TYP.)
Dropout Voltage	: 95mV@ $I_{OUT}=100mA$, $V_{OUT}=3.0V$
Operating Voltage Range	: 1.5V~6.0V
Output Voltage Range	: 0.8V~4.0V (0.05V increments)
High Output Accuracy	: $\pm 1\%$ <XC6416A/B/C/D in HS Mode> $\pm 0.02V$ @ $V_{OUT} \leq 1.95V$ $\pm 2\%$ <XC6416E/F/G/H in HS Mode> $\pm 0.03V$ @ $V_{OUT} \leq 1.45V$ $\pm 3\%$ <XC6416A~H in PS Mode> $\pm 0.06V$ @ $V_{OUT} \leq 1.95V$
Low Power Consumption	: $5 \mu A/ch$ @ PS mode (TYP.) $28 \mu A/ch$ @ HS mode (TYP.)
Stand-by Current	: Less than 0.1 μA
Ripple Rejection Rate	: 60dB @ 1kHz
Operating Temperature Range	: -40°C ~ 85°C
Low ESR Capacitor	: 1.0 μF Ceramic Capacitor Compatible
Packages	: USP-6C, SOT-26
Environmentally Friendly	: EU RoHS Compliant, Pb Free

■ TYPICAL APPLICATION CIRCUITS

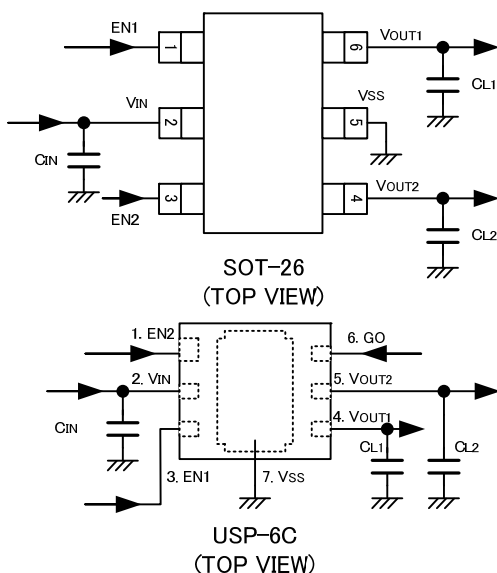

■ TYPICAL PERFORMANCE CHARACTERISTICS

● Load Transient Response

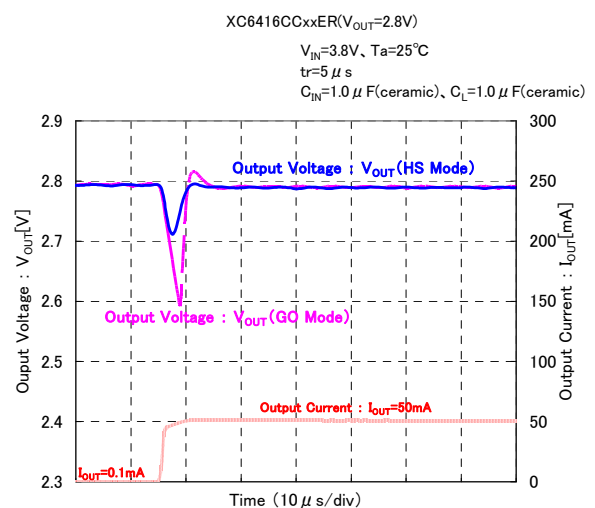

PIN CONFIGURATION

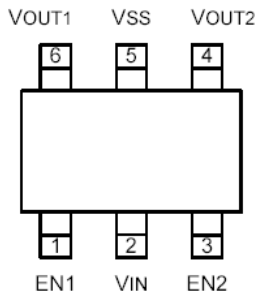

SOT-26
(TOP VIEW)

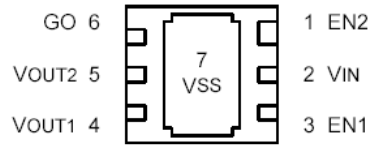

USP-6C
(BOTTOM VIEW)

PIN ASSIGNMENT

PIN NUMBER		PIN NAME	FUNCTION
SOT-26	USP-6C		
1	3	EN1	ON/OFF Control 1
2	2	V _{IN}	Power Input
3	1	EN2	ON/OFF Control 2
4	5	V _{OUT2}	Output 2
5	7	V _{SS}	Ground
6	4	V _{OUT1}	Output 1
-	6	GO	GreenOperation Mode Switching Pin

■ PRODUCT CLASSIFICATION

● Ordering Information

XC6416①②③④⑤⑥-⑦^(*)

SYMBOL	DESCRIPTION	SYMBOL	DESCRIPTION
①	Type of Regulator EN1= High Active	A	Output accuracy 1%, SOT-26 Auto GO, No C _L discharge
		B	Output accuracy 1%, SOT-26 Auto GO, Auto C _L discharge
		C	Output accuracy 1%, USP-6C GO selection pin, No C _L discharge
		D	Output accuracy 1%, USP-6C GO selection pin, Auto C _L discharge
		E	Output accuracy 2%, SOT-26 Auto GO, No C _L discharge
		F	Output accuracy 2%, SOT-26 Auto GO, Auto C _L discharge
		G	Output accuracy 2%, USP-6C GO selection pin, No C _L discharge
		H	Output accuracy 2%, USP-6C GO selection pin, Auto C _L discharge
②	Type of Regulator EN2= High Active	A	Output accuracy 1%, SOT-26 Auto GO, No C _L discharge
		B	Output accuracy 1%, SOT-26 Auto GO, Auto C _L discharge
		C	Output accuracy 1%, USP-6C GO selection pin, No C _L discharge
		D	Output accuracy 1%, USP-6C GO selection pin, Auto C _L discharge
		E	Output accuracy 2%, SOT-26 Auto GO, No C _L discharge
		F	Output accuracy 2%, SOT-26 Auto GO, Auto C _L discharge
		G	Output accuracy 2%, USP-6C GO selection pin, No C _L discharge
		H	Output accuracy 2%, USP-6C GO selection pin, Auto C _L discharge
③④	Two Output Voltage Combination	01~	Internally set sequential number (refer to the table below) Regulator 1 Output Voltage Range: 0.8 ~ 4.0V (0.05V increments) Regulator 2 Output Voltage Range: 0.8 ~ 4.0V (0.05V increments)
⑤⑥-⑦	Packages Taping Type ^(*)	MR	SOT-26
		MR-G	SOT-26
		ER	USP-6C
		ER-G	USP-6C

^(*) The "-G" suffix indicates that the products are Halogen and Antimony free as well as being fully RoHS compliant.

^(*) The device orientation is fixed in its embossed tape pocket. For reverse orientation, please contact your local Torex sales office or representative. (Standard orientation: ⑤R-⑦, Reverse orientation: ⑤L-⑦)

● DESIGNATOR③④

③④	VR1	VR2	③④	VR1	VR2	③④	VR1	VR2
01	1.80	2.80	11	1.30	1.50	21	1.50	2.80
02	1.20	2.90	12	2.80	2.80	22	1.80	3.00
03	1.80	1.80	13	2.50	3.30	23	1.85	2.80
04	1.50	2.70	14	3.00	3.30	24	1.85	3.30
05	2.85	2.85	15	1.20	1.80	25	2.60	2.80
06	1.80	3.30	16	2.80	3.30	26	1.50	1.50
07	3.00	3.00	17	3.30	3.30	27	2.00	3.00
08	2.80	1.80	18	3.10	3.10	28	3.30	1.80
09	1.20	1.20	19	2.80	1.50	29	3.30	1.75
10	1.10	1.30	20	1.30	2.80	31	1.20	2.80

*For other output voltage combinations, please consult to Torex sales offices.

■ BLOCK DIAGRAMS

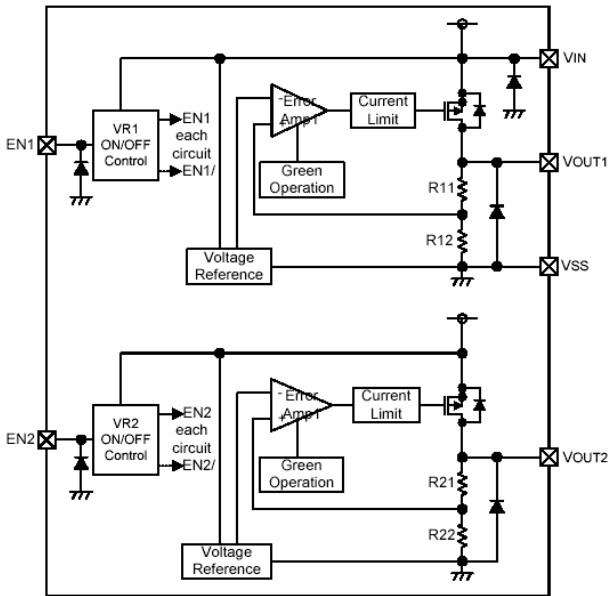

< XC6416AA Series >

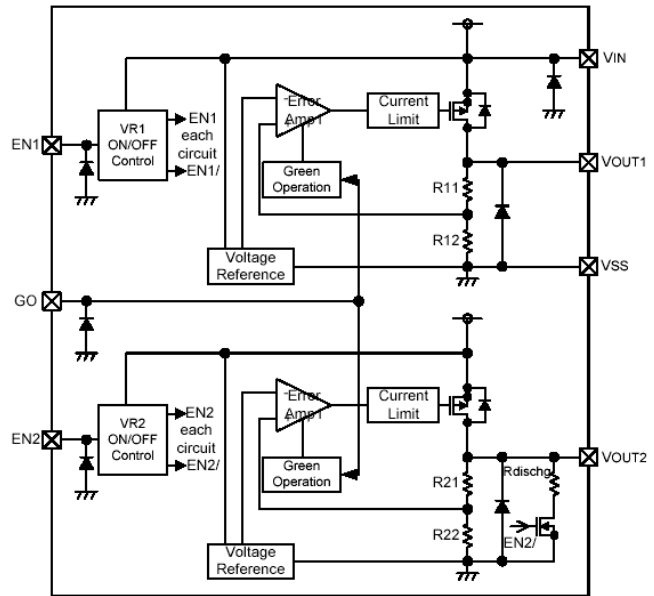

< XC6416CD Series >

* Diodes inside the circuits are ESD protection diodes and parasitic diodes.

■ ABSOLUTE MAXIMUM RATINGS

Ta=25°C

PARAMETER		SYMBOL	RATINGS	UNITS
Input Voltage		V _{IN}	- 0.3 ~ + 6.5	V
Output Current		I _{OUT1} +I _{OUT2}	500 ^(*1)	mA
Output Voltage 1 / Output Voltage 2		V _{OUT1} / V _{OUT2}	V _{SS} - 0.3 V _{IN} + 0.3	V
EN1 / EN2 Input Voltage		V _{EN1} / V _{EN2}	V _{SS} - 0.3 ~ + 6.5	V
Power Dissipation	USP-6C	Pd	120	mW
	SOT-26		1000 (PCB mounted) ^(*2)	
			250	
Operating Temperature Range		T _{opr}	- 40 ~ + 85	°C
Storage Temperature Range		T _{stg}	- 55 ~ + 125	°C

*1) Please use within the range of Pd > { (V_{IN}-V_{OUT1})×I_{OUT1} + (V_{IN}-V_{OUT2})×I_{OUT2} }

*2) This power dissipation figure shown is PCB mounted and is for reference only. Please refer to page 29 for details.

ELECTRICAL CHARACTERISTICS

●XC6416A/B/E/F Series

Regulator 1, Regulator 2

Ta=25°C

PARAMETER	SYMBOL	CONDITIONS	MIN.	TYP.	MAX.	UNITS	CIRCUITS
Output Voltage 1 (HS*)	V _{OUT1(E)} ^(*2)	V _{OUT(T)} ≥ 2.0V, (A/B Series) V _{EN} =V _{IN} , I _{OUT} =10mA	×0.99 (^{*3})	V _{OUT(T)} (^{*4})	×1.01 (^{*3})	V	①
		V _{OUT(T)} ≤ 1.95V, (A/B Series) V _{EN} =V _{IN} , I _{OUT} =10mA	- 0.02 (^{*3})		+ 0.02 (^{*3})		
		V _{OUT(T)} ≥ 1.5V (E/F Series) V _{EN} =V _{IN} , I _{OUT} =10mA	×0.98 (^{*3})		×1.02 (^{*3})		
		V _{OUT(T)} ≤ 1.45V (E/F Series) V _{EN} =V _{IN} , I _{OUT} =10mA	- 0.03 (^{*3})		+ 0.03 (^{*3})		
Output Voltage 2 (PS*)	V _{OUT2(E)} ^(*2)	V _{OUT(T)} ≥ 2.0V, V _{EN} =V _{IN} , I _{OUT} =0.1mA	×0.97 (^{*3})	V _{OUT(T)} (^{*4})	×1.03 (^{*3})	V	①
		V _{OUT} ≤ 1.95V, V _{EN} =V _{IN} , I _{OUT} =0.1mA	- 0.06 (^{*3})		+ 0.06 (^{*3})		
Output Current	I _{OUTMAX}		200	-	-	mA	①
Load Regulation	ΔV _{OUT}	V _{EN} =V _{IN} , 10mA ≤ I _{OUT} ≤ 100mA	E-1			mV	①
Dropout Voltage ^(*5)	V _{dif}	I _{OUT} =100mA, V _{EN} =V _{IN}	E-2			mV	①
Supply Current 1 (HS*)	I _{SS1}	V _{IN} =V _{EN} =V _{OUT(T)} +1.0V,	-	28	60	μA	②
Supply Current 2 (PS*)	I _{SS2}	V _{IN} =V _{EN} =V _{OUT(T)} +1.0V,	-	5.0	12	μA	②
Stand-by Current	I _{STBY}	V _{IN} =6.0V, V _{EN} =V _{SS}	-	0.01	0.1	μA	②
Line Regulation 1 (HS*)	ΔV _{OUT} / (ΔV _{IN} ·V _{OUT})	V _{OUT(T)} +0.5V ≤ V _{IN} ≤ 6.0V V _{OUT(T)} ≥ 1.0V, V _{EN} =V _{IN} , I _{OUT} =10mA	-	0.01	0.2	%V	①
		1.5V ≤ V _{IN} ≤ 6.0V V _{OUT(T)} ≤ 0.95V, V _{EN} =V _{IN} , I _{OUT} =10mA					
Input Voltage	V _{IN}		1.5	-	6.0	V	①
Output Voltage Temperature Characteristics	ΔV _{OUT} / (ΔTa·V _{OUT})	V _{EN} =V _{IN} , I _{OUT} =30mA -40°C ≤ Ta ≤ 85°C	-	±100	-	ppm/°C	①
Ripple Rejection Rate	PSRR	V _{IN} ={V _{OUT(T)} +1.0} V _{DC} +0.5V _{p-pAC}	-	60	-	dB	③
Limit Current	I _{LIM}	V _{EN} =V _{IN}	210	300	-	mA	①
Short Current	I _{SHORT}	V _{EN} =V _{IN} , Short V _{OUT} to V _{SS} level	-	20	-	mA	①
PS Switching Current	I _{GOR}	V _{EN} =V _{IN} , I _{OUT} =Heavy to light load	0.25	1.5		mA	①
HS Switching Current	I _{GO}	V _{EN} =V _{IN} , I _{OUT} =Light to heavy load		4	7.5	mA	①
Switching Current Hysteresis	I _{GOhys}	I _{GOhys} =I _{GO} -I _{GOR}		2.5		mA	①
PS Switching Delay Time	t _{DPS}	V _{EN} =V _{IN} ,	E-3			μs	①
EN High Level Voltage	V _{ENH}		1.2		6	V	①
EN Low Level Voltage	V _{ENL}				0.3	V	①
EN High Level Current	I _{ENH}	V _{EN} =V _{IN}	-0.1		0.1	μA	①
EN Low Level Current	I _{ENL}	V _{EN} =V _{SS}	-0.1		0.1	μA	①
C _L Discharge Resistance ^(*8)	R _{DCHG}	V _{IN} =6.0V, V _{OUT} =4.0V, V _{EN} =V _{SS}		550		Ω	①

NOTE:

*HS: High Speed Mode, PS: Power Save Mode

*1: Unless otherwise stated, V_{IN}=V_{OUT(T)}+1.0V.

*2: V_{OUT(E)}= Nominal output voltage (see the voltage chart)

(ie. The output voltage when “V_{OUT(T)}+1.0V” is provided at the V_{IN} pin while maintaining a certain I_{OUT} value.

*3 : Characteristics of the effective V_{OUT(E)} by nominal output voltage is shown in the voltage chart.

*4 : V_{OUT(T)} : Nominal output voltage

*5: V_{dif}={V_{IN1}^(*7)-V_{OUT1}^(*6)}

*6: V_{OUT1}: A voltage equal to 98% of the V_{OUT(T)} when an amply stabilized V_{OUT(T)}+1.0V is input.

*7: V_{IN1}: The input voltage when the V_{OUT1} voltage appears at the V_{OUT} pin during decreasing input voltage gradually.

*8: For XC6416xB/Bx/xF/Fx series only.

XC6416xA/Ax/xE/Ex series discharge with only Rx1 and Rx2 resistors as shown in the BLOCK DIAGRAMS.

*9: When each channel is measured, the other channel is turned off (V_{EN}=V_{SS}).

ELECTRICAL CHARACTERISTICS (Continued)

Ta=25°C

●XC6416C/D/G/H Series Regulator 1, Regulator 2

PARAMETER	SYMBOL	CONDITIONS	MIN.	TYP.	MAX.	UNITS	CIRCUIT
Output Voltage 1(HS*)	V _{OUT1(E)} ⁽²⁾	V _{OUT(T)} ≥ 2.0V, (C/D Series) V _{EN} =V _{IN} , I _{OUT} =10mA	×0.99 (*3)	V _{OUT(T)} (*4)	×1.01 (*3)	V	①
		V _{OUT} ≤ 1.95V, (C/D Series) V _{EN} =V _{IN} , I _{OUT} =10mA	-0.02 (*3)		+0.02 (*3)		
		V _{OUT(T)} ≥ 1.5V (G/H Series) V _{EN} =V _{IN} , I _{OUT} =10mA	×0.98 (*3)		×1.02 (*3)		
		V _{OUT} ≤ 1.45V (G/H Series) V _{EN} =V _{IN} , I _{OUT} =10mA	-0.03 (*3)		+0.03 (*3)		
Output Voltage 2 (PS*)	V _{OUT2(E)} ⁽²⁾	V _{OUT(T)} ≥ 2.0V, V _{EN} =V _{IN} , I _{OUT} =0.1mA	×0.97 (*3)	V _{OUT(T)} (*4)	×1.03 (*3)	V	①
		V _{OUT} ≤ 1.95V, V _{EN} =V _{IN} , I _{OUT} =0.1mA	-0.06 (*3)		+0.06 (*3)		
Output Current	I _{OUTMAX}		200	-	-	mA	①
Load Regulation	ΔV _{OUT}	V _{EN} =V _{GO} =V _{IN} ,		E-1		mV	①
Dropout Voltage ⁽⁵⁾	V _{dif}	I _{OUT} =100mA, V _{EN} =V _{GO} =V _{IN}		E-2		mV	①
Supply Current 1 (HS*)	I _{SS1}	V _{IN} =V _{EN} =V _{GO} =V _{OUT(T)} +1.0V,	-	28	60	μA	②
Supply Current 2 (PS*)	I _{SS2}	V _{IN} =V _{EN} =V _{OUT(T)} +1.0V,	-	5.0	12	μA	②
Stand-by Current	I _{STBY}	V _{IN} =6.0V, V _{EN} =V _{SS}	-	0.01	0.1	μA	②
Line Regulation 1 (HS*)	ΔV _{OUT} / (ΔV _{IN} ·V _{OUT})	V _{OUT(T)} +0.5V ≤ V _{IN} ≤ 6.0V V _{OUT(T)} ≥ 1.0V, V _{EN} =V _{GO} =V _{IN} , I _{OUT} =10mA	-	0.01	0.2	%V	①
		1.5V ≤ V _{IN} ≤ 6.0V V _{OUT(T)} ≤ 0.95V, V _{EN} =V _{GO} =V _{IN} , I _{OUT} =10mA					
Input Voltage	V _{IN}		1.5	-	6.0	V	①
Output Voltage Temperature Characteristics	ΔV _{OUT} / (ΔTa·V _{OUT})	V _{EN} =V _{GO} =V _{IN} , I _{OUT} =30mA, -40°C ≤ Ta ≤ +85°C	-	±100	-	ppm/°C	①
Ripple Rejection Rate	PSRR	V _{IN} ={V _{OUT(T)} +1.0}V _{DC} +0.5V _{p-pAC}	-	60	-	dB	③
Limit Current	I _{LIM}	V _{EN} =V _{GO} =V _{IN}	210	300	-	mA	①
Short Circuit Current	I _{SHORT}	V _{EN} =V _{GO} =V _{IN} ,	-	20	-	mA	①
PS Switching Current	I _{GOR}	V _{EN} =V _{IN} , V _{GO} =V _{SS}	0.25	1.5	-	mA	①
HS Switching Current	I _{GO}	V _{EN} =V _{IN} , V _{GO} =V _{SS}	-	4	7.5	mA	①
Switching Current Hysteresis	I _{GOhys}	I _{GOhys} =I _{GO} -I _{GOR}	-	2.5	-	mA	①
PS Switching Delay Time	t _{DPS}	V _{EN} =V _{IN} , V _{GO} =V _{SS}		E-3		μs	①
EN High Level Voltage	V _{ENH}		1.2	-	6	V	①
EN Low Level Voltage	V _{ENL}		-	-	0.3	V	①
EN High Level Current	I _{ENH}	V _{EN} =V _{GO} =V _{IN} =6.0V	-0.1	-	0.1	μA	①
EN Low Level Current	I _{ENL}	V _{IN} =6.0V, V _{EN} =V _{GO} =V _{SS}	-0.1	-	0.1	μA	①
GO High Level Voltage	V _{GOH}	V _{EN} =V _{IN} , I _{OUT} =0mA	1.2	-	6	V	①
GO Low Level Voltage	V _{GOL}	V _{EN} =V _{IN} , I _{OUT} =0mA	-	-	0.3	V	①
GO High Level Current	I _{GOH}	V _{EN} =V _{GO} =V _{IN} =6.0V	-0.1	-	0.1	μA	①
GO Low Level Current	I _{GOL}	V _{IN} =6.0V, V _{EN} =V _{GO} =V _{SS}	-0.1	-	0.1	μA	①
C _L Discharge Resistor ⁽⁸⁾	R _{DCHG}	V _{IN} =6.0V, V _{OUT} =4.0V, V _{EN} =V _{SS}	-	550	-	Ω	①

NOTE:

*HS: High Speed Mode, PS: Power Save Mode

*1: Unless otherwise stated, V_{IN}=V_{OUT(T)}+1.0V.

*2: V_{OUT(E)}= Nominal output voltage (see the voltage chart)

(ie. The output voltage when "V_{OUT(T)}+1.0V" is provided at the V_{IN} pin while maintaining a certain I_{OUT} value.

*3: Characteristics of the effective V_{OUT(E)} by nominal output voltage is shown in the voltage chart.

*4: V_{OUT(T)}: Nominal output voltage

*5: V_{dif}={V_{IN1}⁽⁷⁾-V_{OUT1}⁽⁶⁾}

*6: V_{OUT1}: A voltage equal to 98% of the V_{OUT(T)} when an amply stabilized V_{OUT(T)}+1.0V is input.

*7: V_{IN1}: The input voltage when the V_{OUT1} voltage appears at the V_{OUT} pin during decreasing input voltage gradually.

*8: For XC6416xD/Dx/xH/Hx series only.

XC6416xC/Cx/xG/Gx series discharge with only Rx1 and Rx2 resistors as shown in the BLOCK DIAGRAMS.

*9: When each channel is measured, the other channel is turned off (V_{EN}=V_{SS}).

■ ELECTRICAL CHARACTERISTICS (Continued)

● Output Voltage Table

NOMINAL OUTPUT VOLTAGE (V)	OUTPUT VOLTAGE 1% IN HS MODE (V)		OUTPUT VOLTAGE 2% IN PS MODE (V)		OUTPUT VOLTAGE 3% IN PS MODE (V)		LOAD REGULATION E-1 (mV)		DROPOUT VOLTAGE E-2 (mV)		PS SWITCHING DELEAY TIME E-3 (μ s)	
	$V_{OUT1(E)}$		$V_{OUT1(E)}$		$V_{OUT2(E)}$		ΔV_{OUT}		V_{dif}		t_{DPS}	
	MIN.	MAX.	MIN.	MIN.	MIN.	MAX.	TYP.	MAX.	TYP.	MAX.	TYP.	MAX.
0.80	0.7800	0.8200	0.7700	0.8300	0.7400	0.8600	10	30	500	850	250	850
0.85	0.8300	0.8700	0.8200	0.8800	0.7900	0.9100	10	30	500	850	250	850
0.90	0.8800	0.9200	0.8700	0.9300	0.8400	0.9600	10	30	410	750	250	850
0.95	0.9300	0.9700	0.9200	0.9800	0.8900	1.0100	10	30	410	750	250	850
1.00	0.9800	1.0200	0.9700	1.0300	0.9400	1.0600	10	30	360	600	250	850
1.05	1.0300	1.0700	1.0200	1.0800	0.9900	1.1100	10	30	360	600	250	850
1.10	1.0800	1.1200	1.0700	1.1300	1.0400	1.1600	10	30	330	500	250	850
1.15	1.1300	1.1700	1.1200	1.1800	1.0900	1.2100	10	30	330	500	250	850
1.20	1.1800	1.2200	1.1700	1.2300	1.1400	1.2600	10	30	280	420	250	850
1.25	1.2300	1.2700	1.2200	1.2800	1.1900	1.3100	10	30	280	420	250	850
1.30	1.2800	1.3200	1.2700	1.3300	1.2400	1.3600	10	30	240	360	250	850
1.35	1.3300	1.3700	1.3200	1.3800	1.2900	1.4100	10	30	240	360	250	850
1.40	1.3800	1.4200	1.3700	1.4300	1.3400	1.4600	10	30	200	300	250	850
1.45	1.4300	1.4700	1.4200	1.4800	1.3900	1.5100	10	30	200	300	250	850
1.50	1.4800	1.5200	1.4700	1.5300	1.4400	1.5600	10	30	180	260	250	850
1.55	1.5300	1.5700	1.5190	1.5810	1.4900	1.6100	10	30	180	260	250	850
1.60	1.5800	1.6200	1.5680	1.6320	1.5400	1.6600	10	30	170	240	250	850
1.65	1.6300	1.6700	1.6170	1.6830	1.5900	1.7100	10	30	170	240	250	850
1.70	1.6800	1.7200	1.6660	1.7340	1.6400	1.7600	10	30	170	240	250	850
1.75	1.7300	1.7700	1.7150	1.7850	1.6900	1.8100	10	30	170	240	250	850
1.80	1.7800	1.8200	1.7640	1.8360	1.7400	1.8600	10	30	150	200	250	850
1.85	1.8300	1.8700	1.8130	1.8870	1.7900	1.9100	10	30	150	200	250	850
1.90	1.8800	1.9200	1.8620	1.9380	1.8400	1.9600	10	30	150	200	250	850
1.95	1.9300	1.9700	1.9110	1.9890	1.8900	2.0100	10	30	150	200	250	850
2.00	1.9800	2.0200	1.9600	2.0400	1.9400	2.0600	20	50	150	200	400	1500
2.05	2.0295	2.0705	2.0090	2.0910	1.9885	2.1115	20	50	150	200	400	1500
2.10	2.0790	2.1210	2.0580	2.1420	2.0370	2.1630	20	50	150	200	400	1500
2.15	2.1285	2.1715	2.1070	2.1930	2.0855	2.2145	20	50	150	200	400	1500
2.20	2.1780	2.2220	2.1560	2.2440	2.1340	2.2660	20	50	120	180	400	1500
2.25	2.2275	2.2725	2.2050	2.2950	2.1825	2.3175	20	50	120	180	400	1500
2.30	2.2770	2.3230	2.2540	2.3460	2.2310	2.3690	20	50	120	180	400	1500
2.35	2.3265	2.3735	2.3030	2.3970	2.2795	2.4205	20	50	120	180	400	1500
2.40	2.3760	2.4240	2.3520	2.4480	2.3280	2.4720	20	50	120	180	400	1500
2.45	2.4255	2.4745	2.4010	2.4990	2.3765	2.5235	20	50	120	180	400	1500
2.50	2.4750	2.5250	2.4500	2.5500	2.4250	2.5750	20	50	110	180	400	1500
2.55	2.5245	2.5755	2.4990	2.6010	2.4735	2.6265	20	50	110	180	400	1500
2.60	2.5740	2.6260	2.5480	2.6520	2.5220	2.6780	20	50	110	180	400	1500
2.65	2.6235	2.6765	2.5970	2.7030	2.5705	2.7295	20	50	110	180	400	1500
2.70	2.6730	2.7270	2.6460	2.7540	2.6190	2.7810	20	50	110	180	400	1500
2.75	2.7225	2.7775	2.6950	2.8050	2.6675	2.8325	20	50	110	180	400	1500
2.80	2.7720	2.8280	2.7440	2.8560	2.7160	2.8840	20	50	95	150	400	1500
2.85	2.8215	2.8785	2.7930	2.9070	2.7645	2.9355	20	50	95	150	400	1500
2.90	2.8710	2.9290	2.8420	2.9580	2.8130	2.9870	20	50	95	150	400	1500
2.95	2.9205	2.9795	2.8910	3.0090	2.8615	3.0385	20	50	95	150	400	1500

■ ELECTRICAL CHARACTERISTICS (Continued)

● Output Voltage Table (Continued)

NOMINAL OUTPUT VOLTAGE VOLTAGE (V)	OUTPUT VOLTAGE 1% IN HS MODE (V)		OUTPUT VOLTAGE 2% IN PS MODE (V)		OUTPUT VOLTAGE 3% IN PS MODE (V)		LOAD REGULATION E-1 (mV)		DROPOUT VOLTAGE E-2 (mV)		PS SWITCHING DELEAY TIME E-3 (μ s)	
	$V_{OUT1(E)}$		$V_{OUT1(E)}$		$V_{OUT2(E)}$		ΔV_{OUT}		V_{dif}		t_{DPS}	
	MIN.	MAX.	MIN.	MIN.	MIN.	MAX.	MIN.	MAX.	MIN.	MIN.	MIN.	MAX.
3.00	2.9700	3.0300	2.9400	3.0600	2.9100	3.0900	20	50	95	150	400	1500
3.05	3.0195	3.0805	2.9890	3.1110	2.9585	3.1415	20	50	95	150	400	1500
3.10	3.0690	3.1310	3.0380	3.1620	3.0070	3.1930	20	50	95	150	400	1500
3.15	3.1185	3.1815	3.0870	3.2130	3.0555	3.2445	20	50	95	150	400	1500
3.20	3.1680	3.2320	3.1360	3.2640	3.1040	3.2960	20	50	95	150	400	1500
3.25	3.2175	3.2825	3.1850	3.3150	3.1525	3.3475	20	50	95	150	400	1500
3.30	3.2670	3.3330	3.2340	3.3660	3.2010	3.3990	20	50	80	150	400	1500
3.35	3.3165	3.3835	3.2830	3.4170	3.2495	3.4505	20	50	80	150	400	1500
3.40	3.3660	3.4340	3.3320	3.4680	3.2980	3.5020	20	50	80	150	400	1500
3.45	3.4155	3.4845	3.3810	3.5190	3.3465	3.5535	20	50	80	150	400	1500
3.50	3.4650	3.5350	3.4300	3.5700	3.3950	3.6050	20	50	80	150	400	1500
3.55	3.5145	3.5855	3.4790	3.6210	3.4435	3.6565	20	50	80	150	400	1500
3.60	3.5640	3.6360	3.5280	3.6720	3.4920	3.7080	20	50	80	150	400	1500
3.65	3.6135	3.6865	3.5770	3.7230	3.5405	3.7595	20	50	80	150	400	1500
3.70	3.6630	3.7370	3.6260	3.7740	3.5890	3.8110	20	50	80	150	400	1500
3.75	3.7125	3.7875	3.6750	3.8250	3.6375	3.8625	20	50	80	150	400	1500
3.80	3.7620	3.8380	3.7240	3.8760	3.6860	3.9140	20	50	80	150	400	1500
3.85	3.8115	3.8885	3.7730	3.9270	3.7345	3.9655	20	50	80	150	400	1500
3.90	3.8610	3.9390	3.8220	3.9780	3.7830	4.0170	20	50	80	150	400	1500
3.95	3.9105	3.9895	3.8710	4.0290	3.8315	4.0685	20	50	80	150	400	1500
4.00	3.9600	4.0400	3.9200	4.0800	3.8800	4.1200	30	60	80	120	400	1500

OPERATIONAL DESCRIPTION

<Output Voltage Control>

The voltage divided by resistors Rx1 & Rx2 is compared with the internal reference voltage by the error amplifier. The P-channel MOSFET connected to the VOUT pin is then driven by the subsequent output signal. The output voltage at the VOUT pin is controlled & stabilized by a system of negative feedback. The current limit circuit and short protect circuit operate in relation to the level of output current. Further, the IC's internal circuitry can be shutdown via the EN pin's signal.

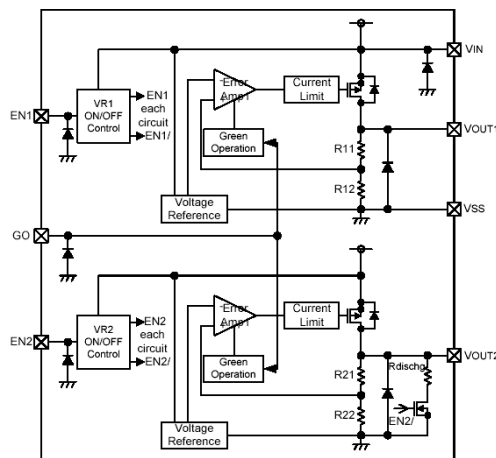

< XC6416CD Series >

<GreenOperation>

XC6416C/D/G/H series can be set as a fixed high-speed (HS) mode or a green operation (GO) mode via a signal to the green operation (GO) pin. The IC operates in the GO mode when the GO pin becomes low level and the IC operates in the fixed high-speed mode when the GO pin becomes high level. The XC6416A/B/E/F series normally operates in GO mode because the GO signal is fixed to the V_{SS} level inside the IC. The GO mode enables the IC to switch automatically the supply current to the high speed (HS) mode and the power save (PS) mode according to the level of output current. While having both high-speed operation and low supply current state, the series can acquire high efficiency. At the HS/PS automatic switching mode (GO mode), the switching point of the HS mode and the PS mode is being fixed inside the IC. When the output current becomes I_{GOR} 1.5mA (TYP.) or below, the mode changes automatically to the PS mode after the delay time of hundreds μs (TYP.), and it can reduce supply current in light load. Also when the output current becomes I_{GO} 4mA (TYP.) or more, the mode changes automatically to the HS mode and the IC becomes high speed operation.

<Input and Output Capacitor>

The XC6416 needs an output capacitor for phase compensation. The requested capacitance values are described in the table below. The device may go into unstable operation when the output capacitance reduction happens as a result of bias or temperature drift. Please choose a capacitor with less influence from temperature and bias. Also, please place 1.0 μF input capacitor C_L between V_{IN} and V_{SS} pins for stabilizing input supply voltage.

Output Capacitor Table

OUTPUT VOLTAGE	OUTPUT CAPACITOR
0.8V~2.35V	C _L ≥ 2.2 μF
2.4V~4.0V	C _L ≥ 1.0 μF

■ OPERATIONAL DESCRIPTION (Continued)

<CL Auto-Discharge Function>

XC6416B/D/F/H series can quickly discharge the electric charge at the output capacitor (CL), when a low signal to the EN pin, which enables a whole IC circuit put into OFF state, is inputted via the N-channel transistor located between the VOUT pin and the VSS pin (cf. BLOCK DIAGRAM). The CL discharge resistance is set to 550Ω when VIN is 6.0V (TYP.) and VOUT is 4.0V (TYP.). Moreover, discharge time of the output capacitor (CL) is set by the CL auto-discharge resistance (R) and the output capacitor (CL). By setting time constant of a CL auto-discharge resistance value [R] and an output capacitor value (CL) as τ ($\tau = C \times R$), the output voltage after discharge via the N channel transistor is calculated by the following formulas.

$$V = V_{OUT} \times e^{-t/\tau}, \text{ or } t = \tau \ln (V / V_{OUT})$$

V : Output voltage after discharge, VOUT(E) : Output voltage, t: Discharge time,
 τ : CL auto-discharge resistance R × Output capacitor (CL) value C

CL high-speed discharge function can be set by each regulator.

<Current Limiter, Short-Circuit Protection>

The XC6416 series includes a fold-back circuit, which aid the operations of the current limiter and circuit protection. When the load current reaches the current limit level, the fold-back circuit operates and output voltage drops. As a result of this drop in output voltage, output current also decreases. When the output pin is shorted, a current of about 20mA (TYP.) flows.

<EN Pin>

The IC's internal circuitry can be shutdown via the signal from the EN pin with the XC6416 series. In shutdown mode, output at the VOUT pin will be pulled down to the VSS level via Rx1 & Rx2. However, as for the XC6416B/D/F/H series, the CL auto-discharge resistor is connected in parallel to Rx1 and Rx2 while the power supply is applied to the VIN pin. Therefore, time until the VOUT pin reaches the VSS level becomes short. The output voltage becomes unstable, when the EN pin is open. If this IC is used with the correct output voltage for the EN pin, the logic is fixed and the IC will operate normally. However, supply current may increase as a result of through current in the IC's internal circuitry when medium voltage is input.

■ NOTES ON USE

1. Please use this IC within the stated absolute maximum ratings. The IC is liable to malfunction should the ratings be exceeded.
2. Where wiring impedance is high, operations may become unstable due to noise and/or phase lag depending on output current. Please wire the input capacitor (CIN) and the output capacitor (CL) as close to the IC as possible.

TEST CIRCUITS

● Circuit ①

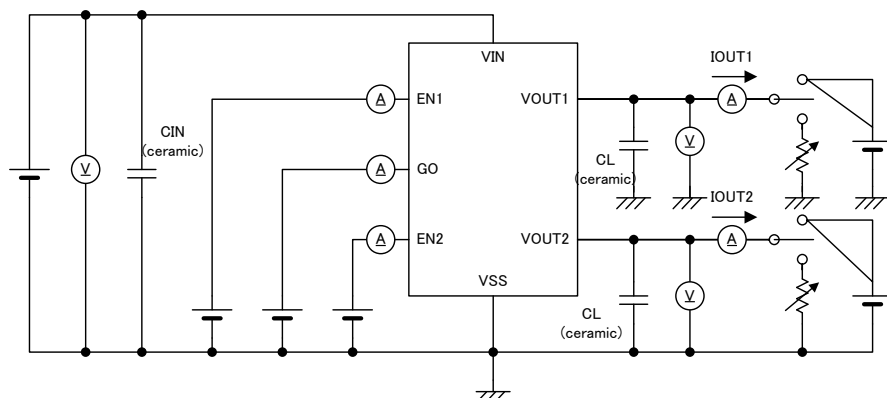

● Circuit ②

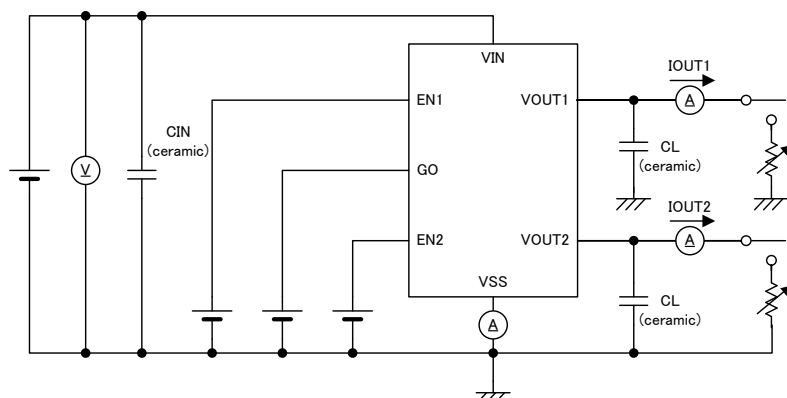

● Circuit ③

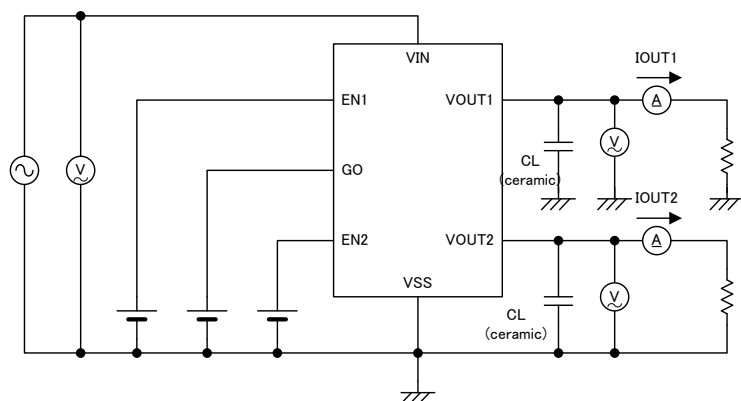

*XC6416Ax/xA/Bx/xB/Ex/xE/Fx/xF do not have GO pin so that the test circuits ①~③ are different from the figures in this page.

TYPICAL PERFORMANCE CHARACTERISTICS

* EN and GO Voltage condition: Unless otherwise stated, $V_{EN}=V_{GO}=V_{IN}$ while the other channel is turned off ($V_{EN}=V_{SS}$).

(1) Output Voltage vs. Output Current

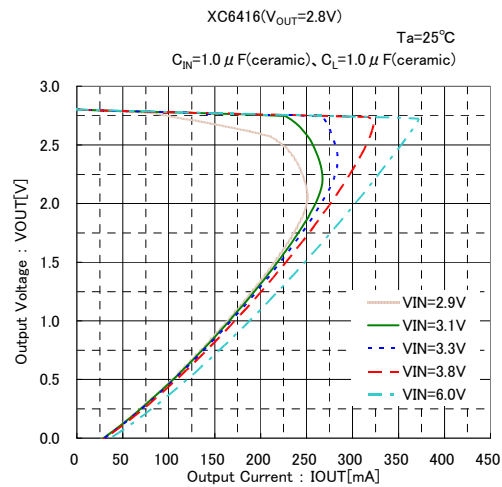
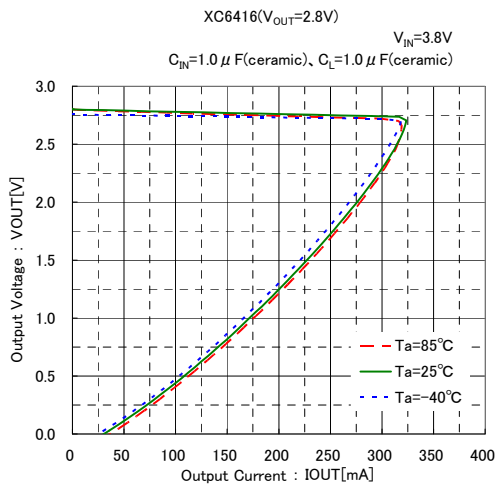
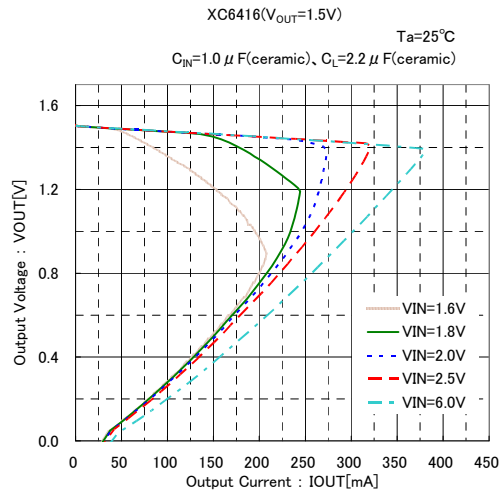
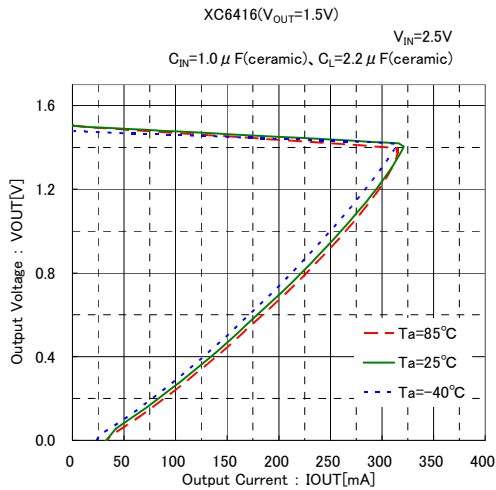
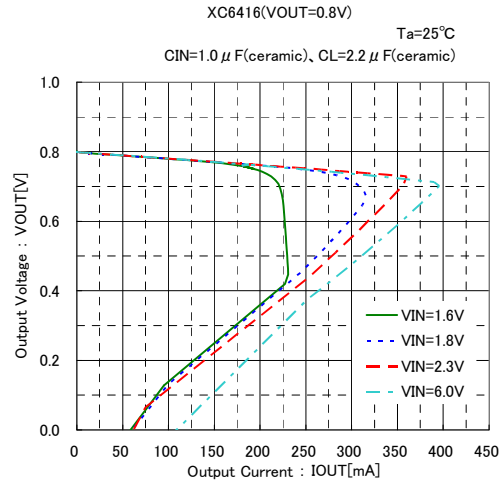
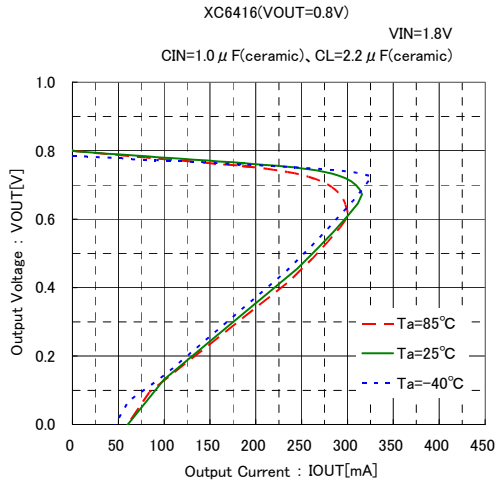

■ TYPICAL PERFORMANCE CHARACTERISTICS (Continued)

(1) Output Voltage vs. Output Current (Continued)

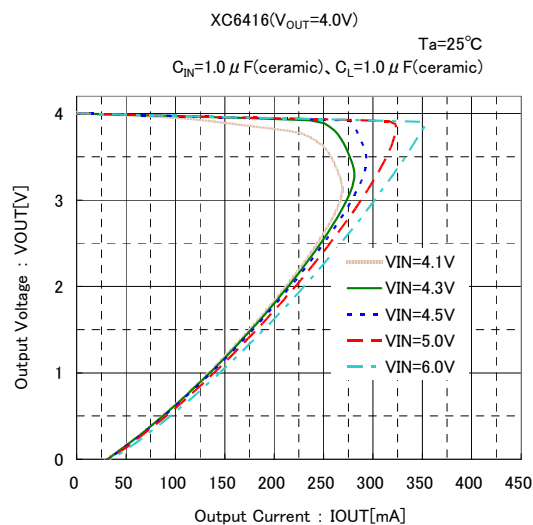
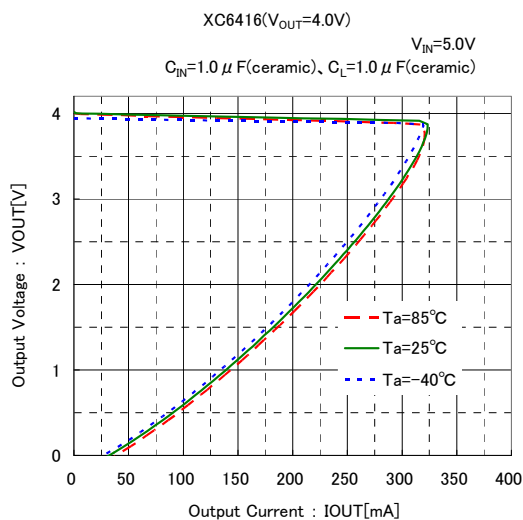

(2) Output Voltage vs. Input Voltage

■ HS mode ($V_{GO}=V_{IN}$)

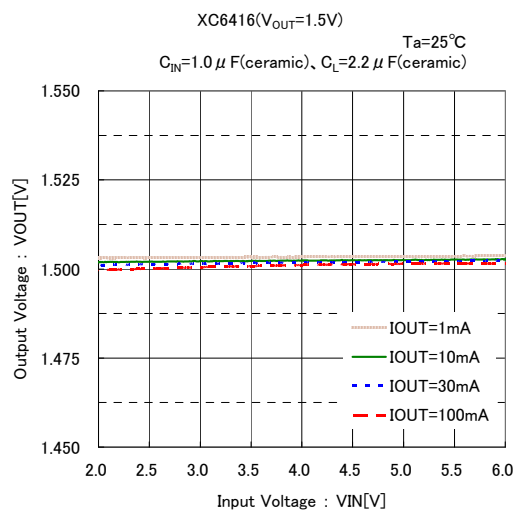
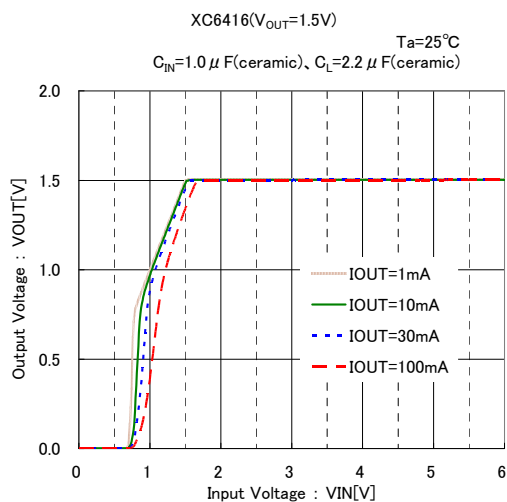
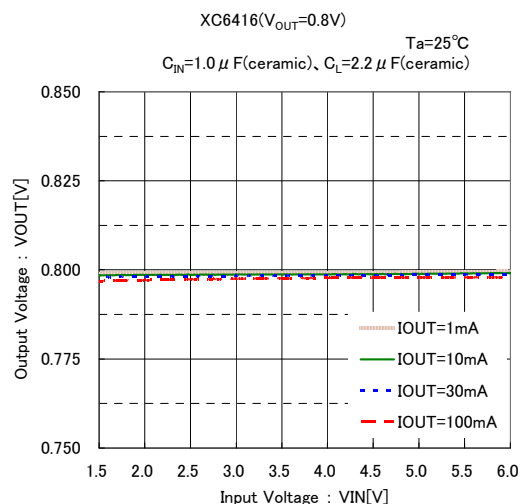
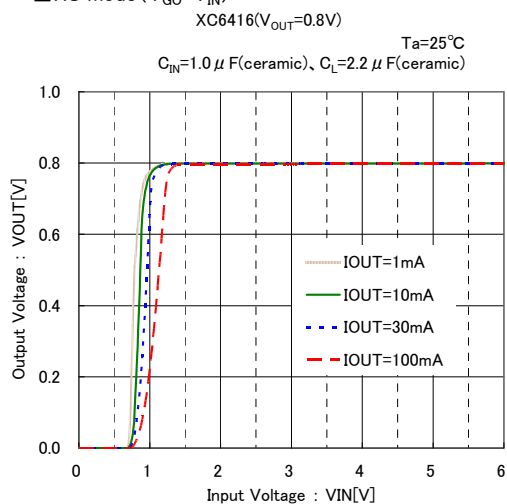

TYPICAL PERFORMANCE CHARACTERISTICS (Continued)

(2) Output Voltage vs. Input Voltage (Continued)

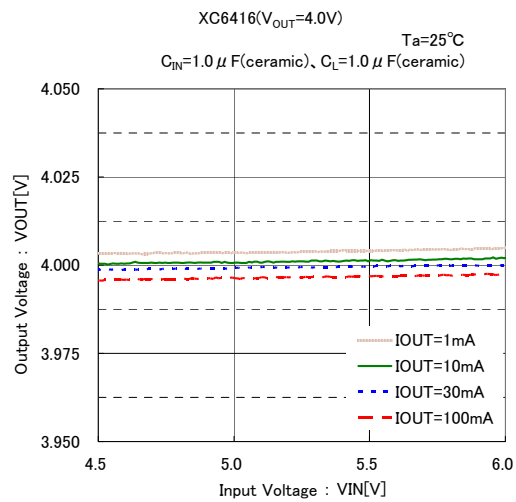
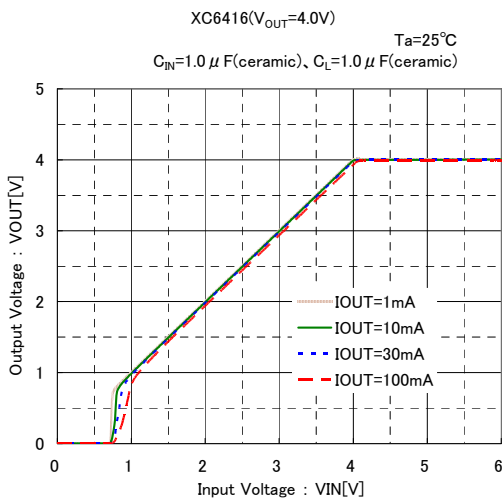
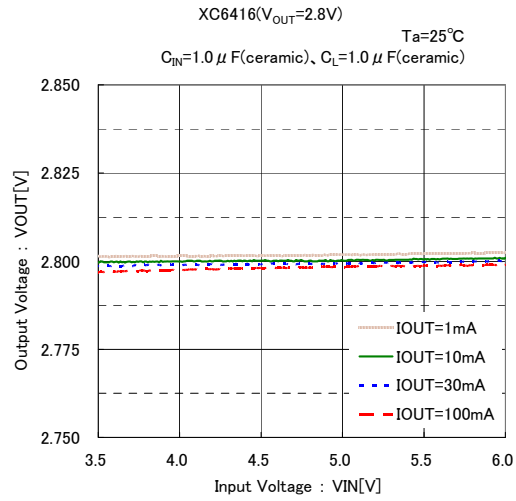
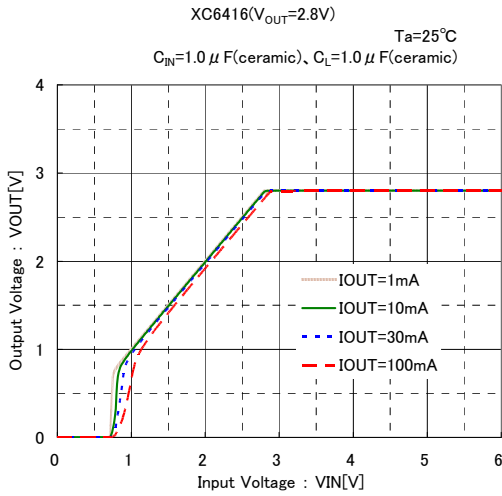

GreenOperation mode ($V_{GO}=V_{SS}$)

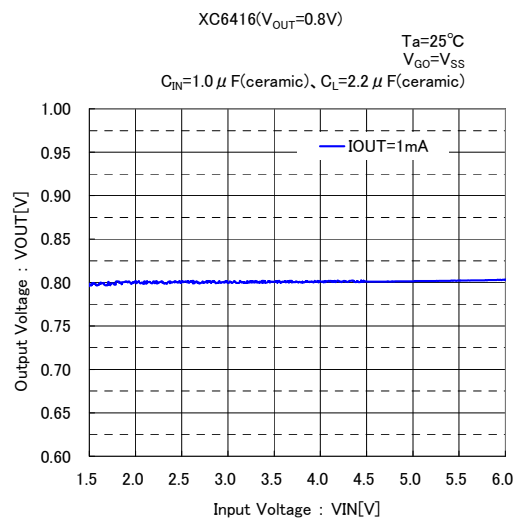
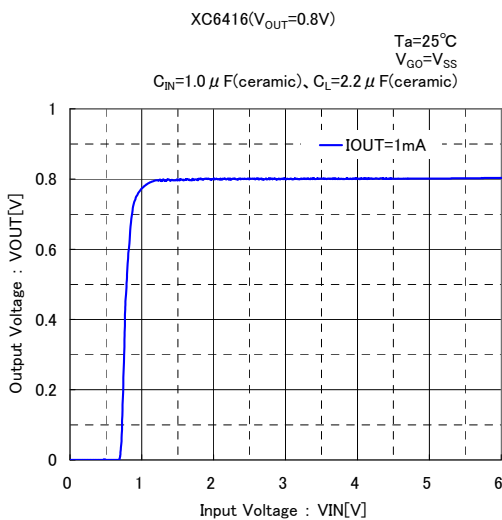

■ TYPICAL PERFORMANCE CHARACTERISTICS (Continued)

(2) Output Voltage vs. Input Voltage (Continued)

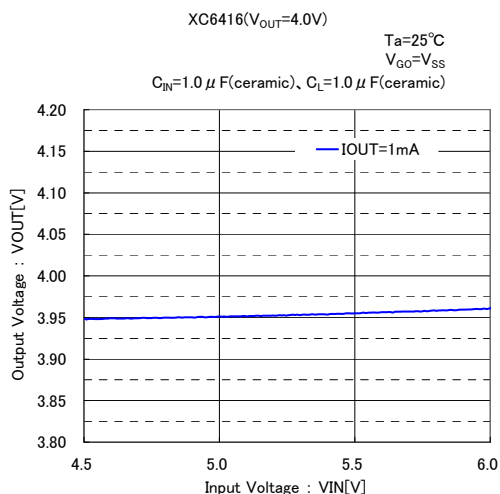
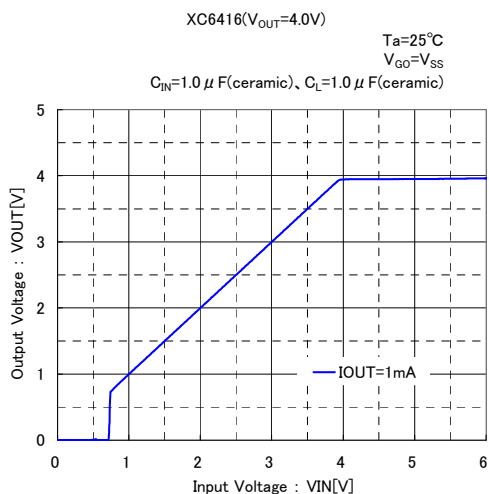
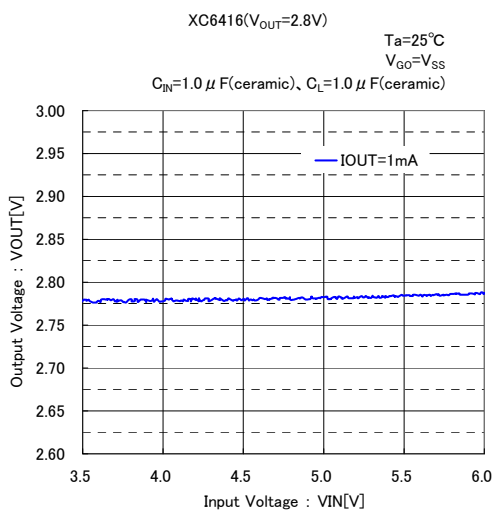
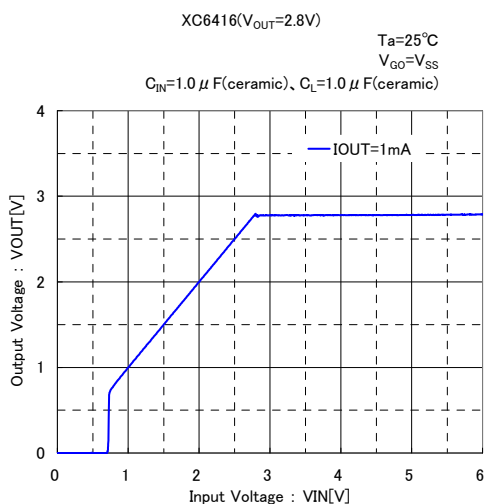
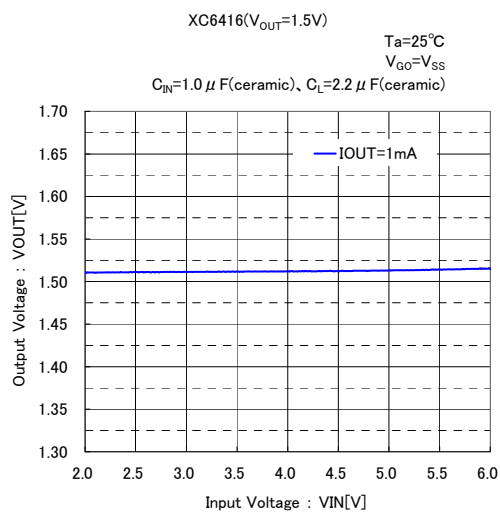
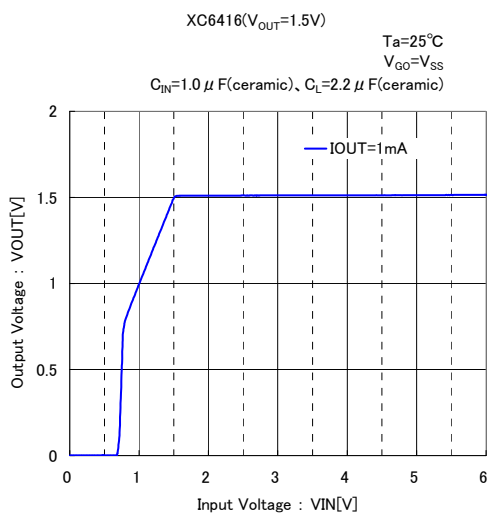

TYPICAL PERFORMANCE CHARACTERISTICS (Continued)

(3) Dropout Voltage vs. Output Current

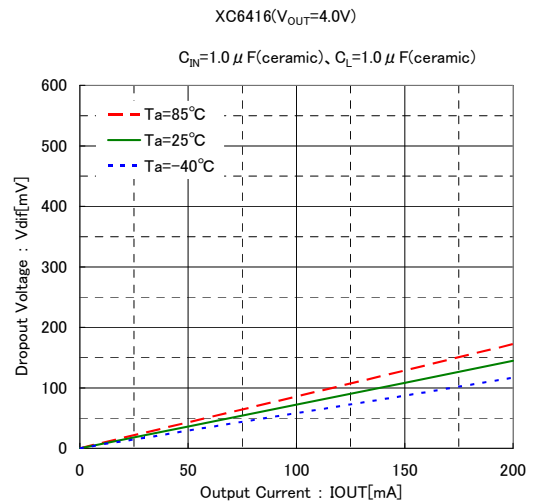
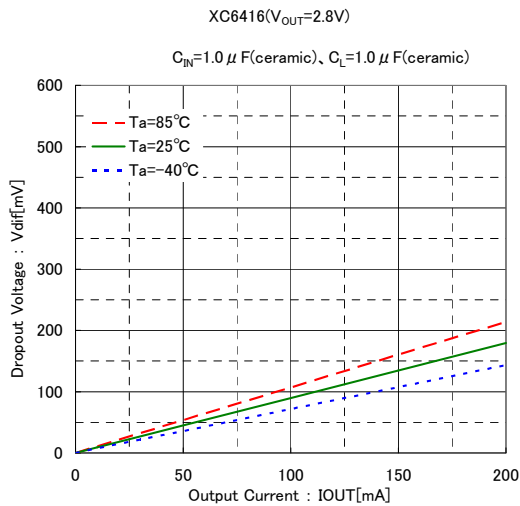
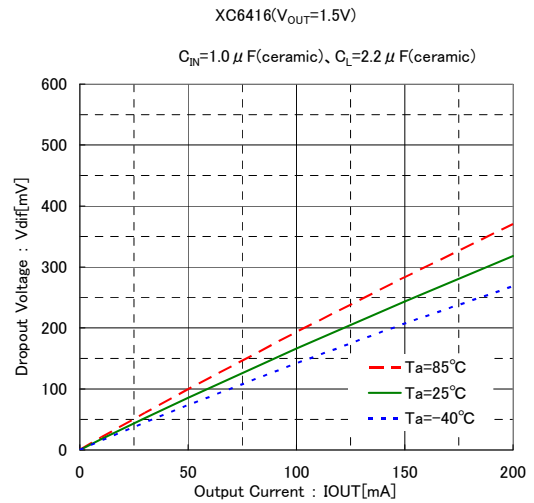
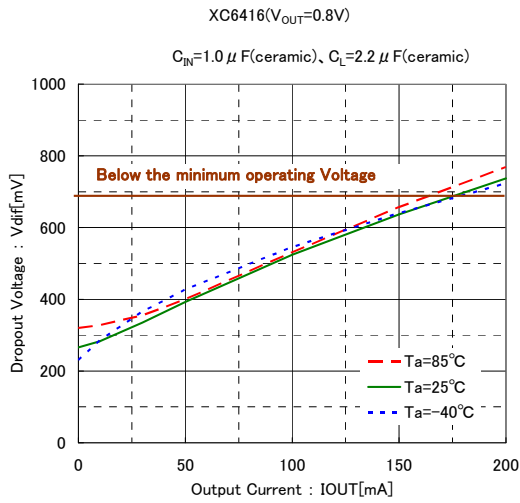

(4) Supply Current vs. Input Voltage

■ HS mode ($V_{GO}=V_{IN}$)

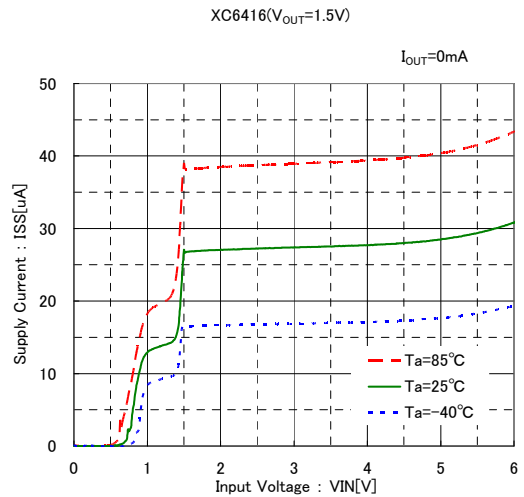
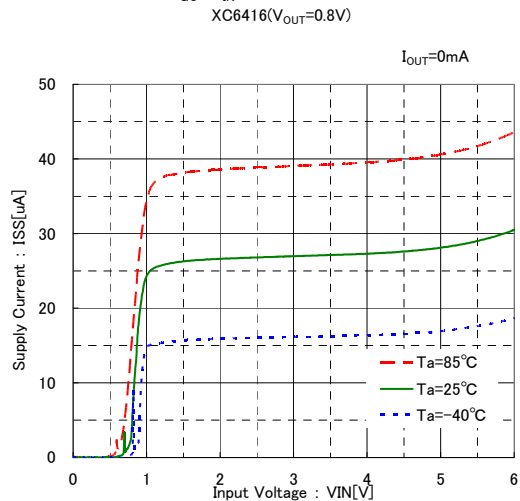

TYPICAL PERFORMANCE CHARACTERISTICS (Continued)

(4) Supply Current vs. Input Voltage (Continued)

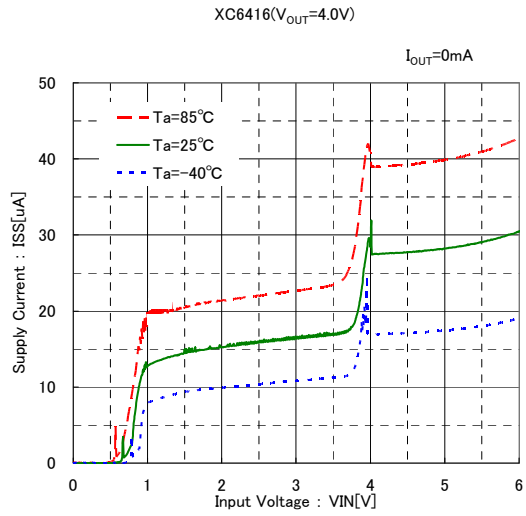
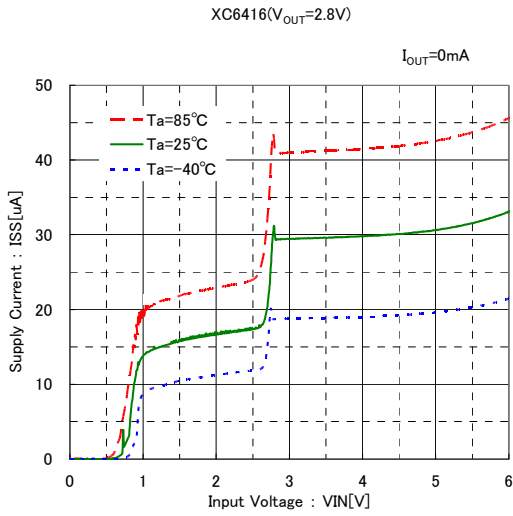

GreenOperation mode ($V_{GO}=V_{SS}$)

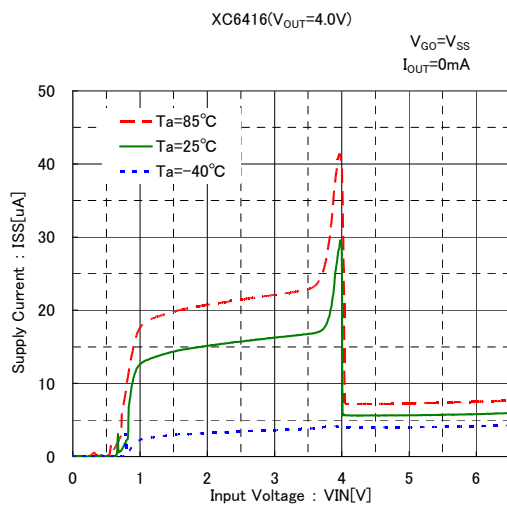
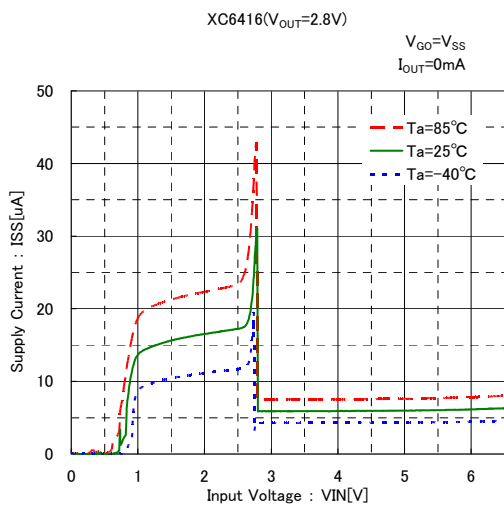
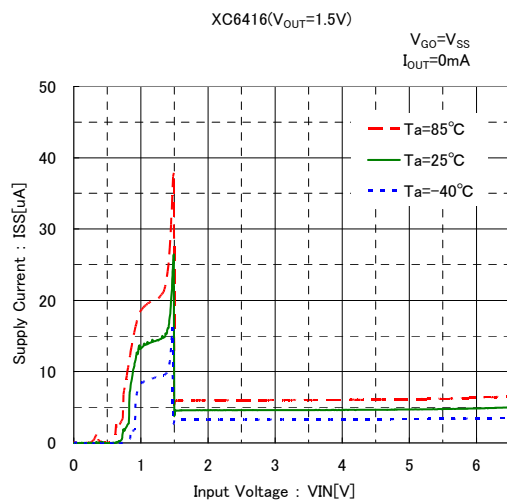
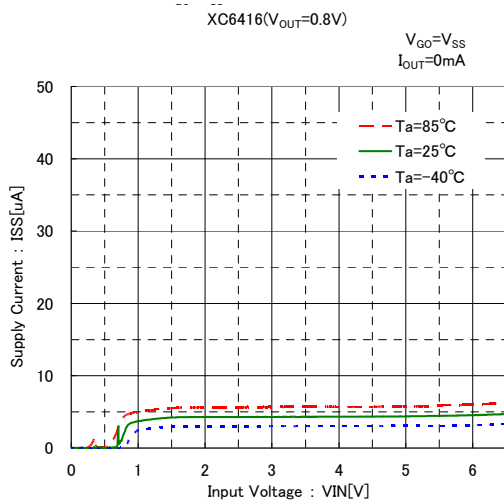

TYPICAL PERFORMANCE CHARACTERISTICS (Continued)

(5) Output Voltage vs. Ambient Temperature

■ GreenOperation mode ($V_{GO}=V_{SS}$)

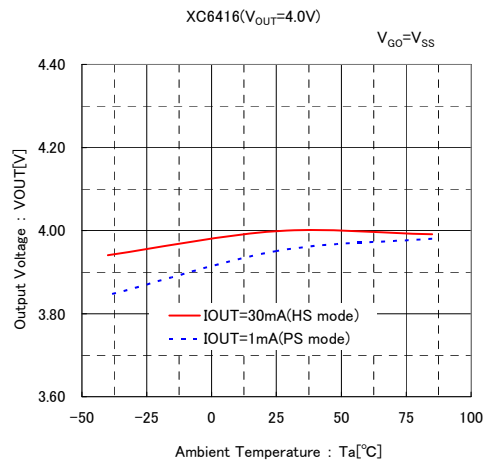
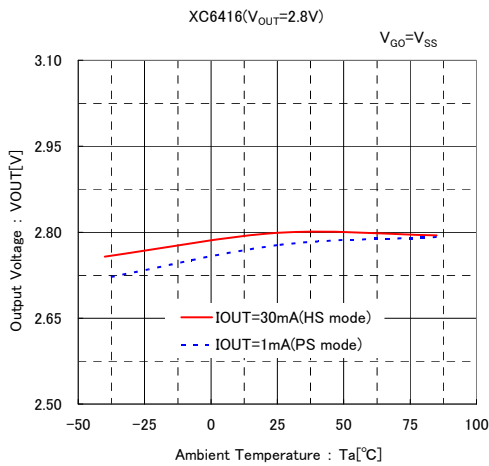
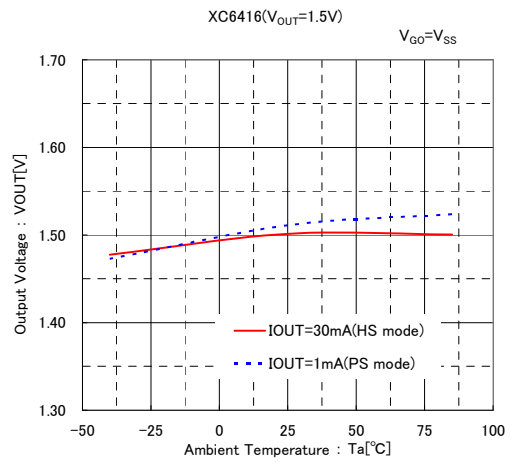
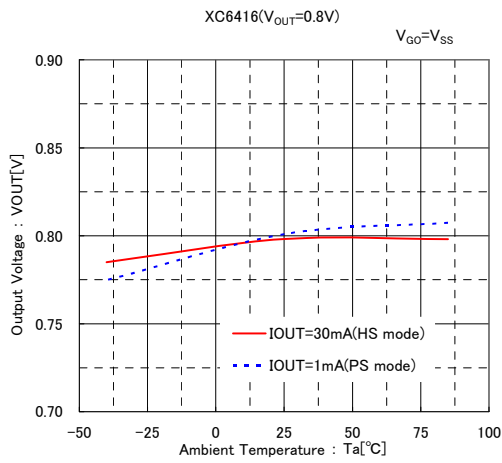

(6) EN Threshold Voltage vs. Ambient Temperature

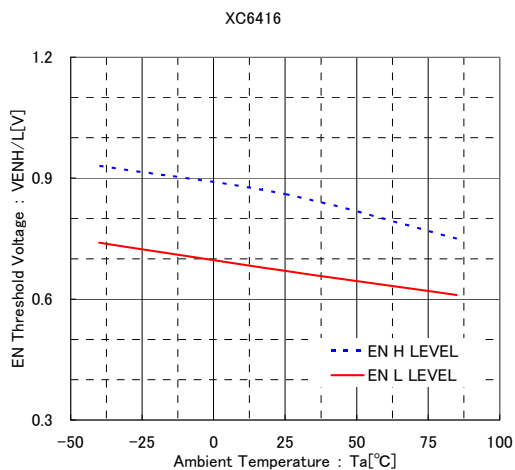

(7) GO Threshold Voltage vs. Ambient Temperature

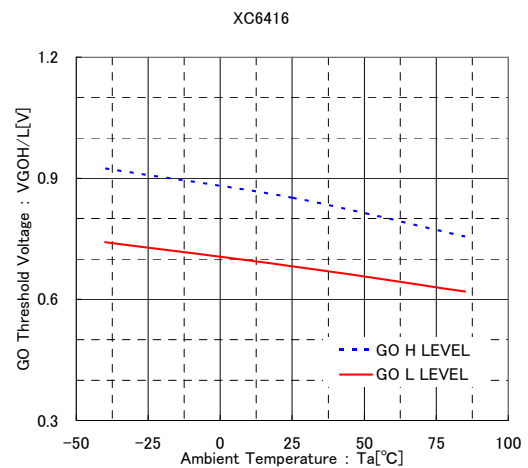

■ TYPICAL PERFORMANCE CHARACTERISTICS (Continued)

(8) PS/HS Switch Current vs. Ambient Temperature

■ GreenOperation mode ($V_{GO}=V_{SS}$)

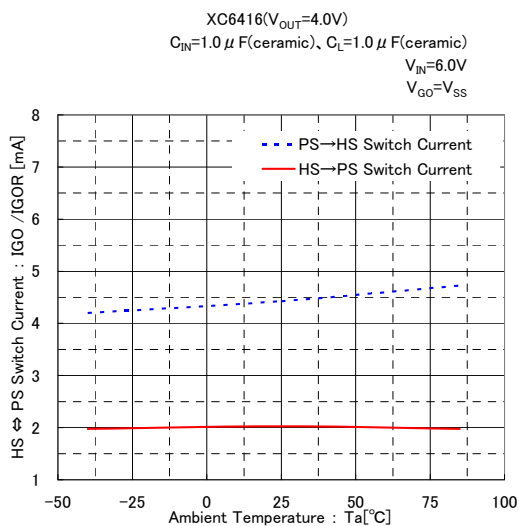
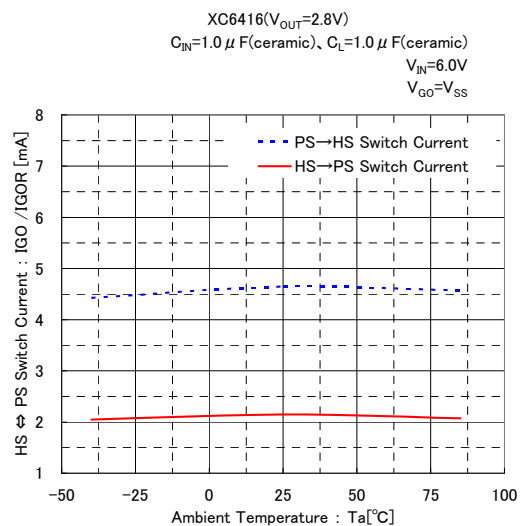
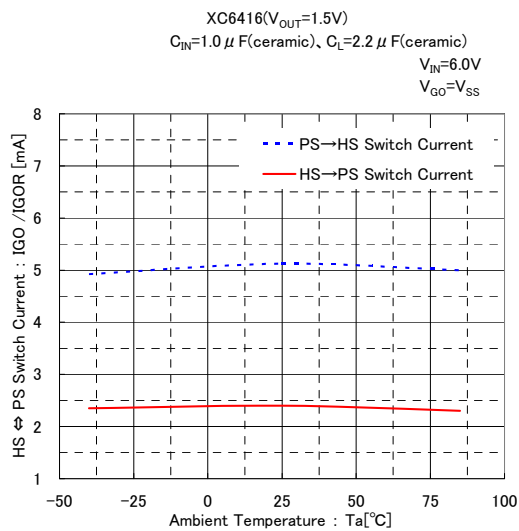
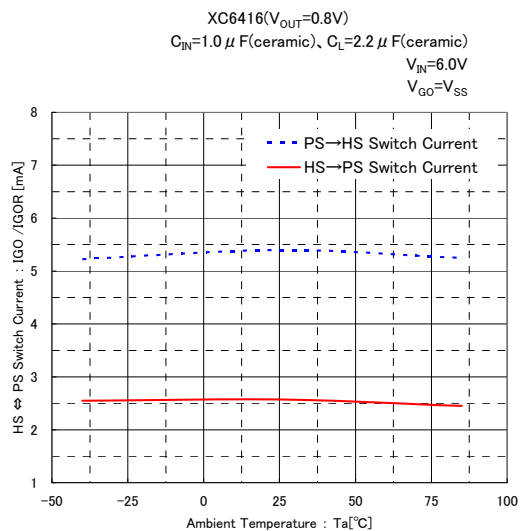

TYPICAL PERFORMANCE CHARACTERISTICS (Continued)

(9) Rising Response Time

HS mode ($V_{GO}=V_{IN}$)

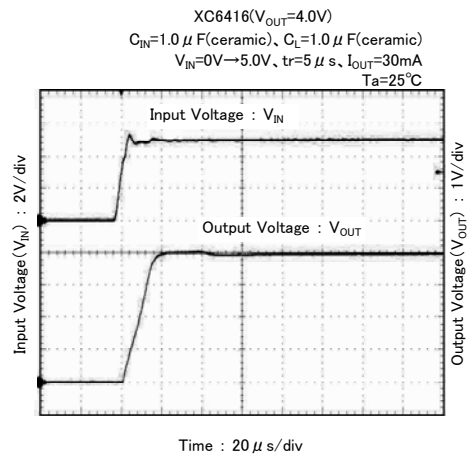
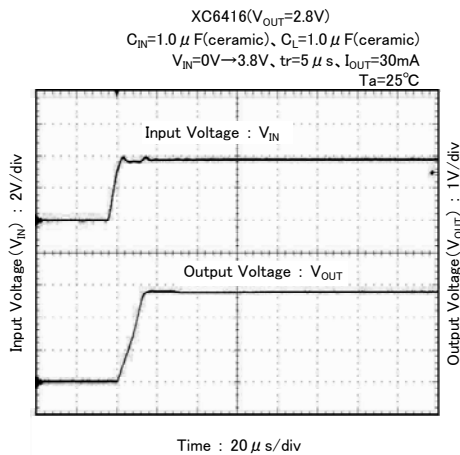
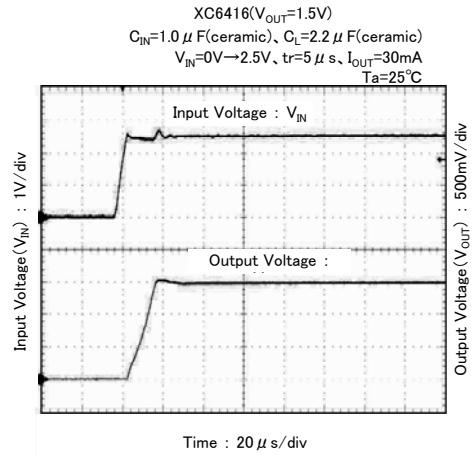
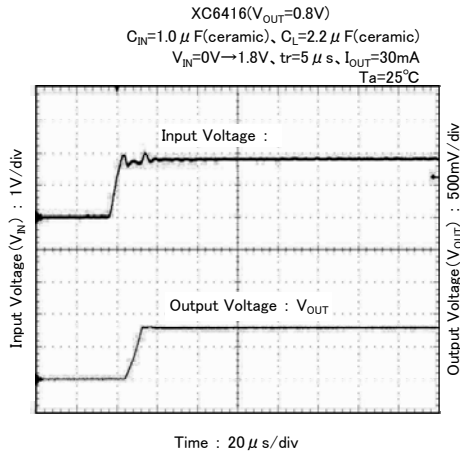

GreenOperation mode ($V_{GO}=V_{SS}$)

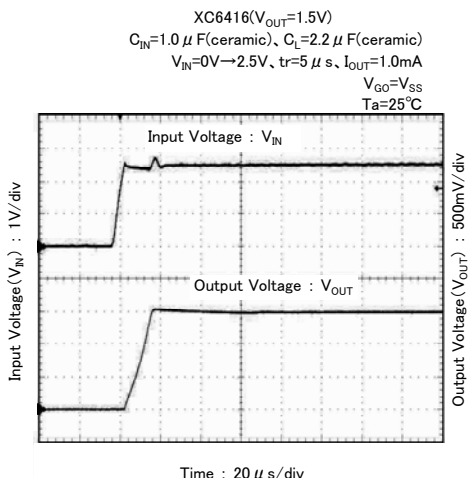
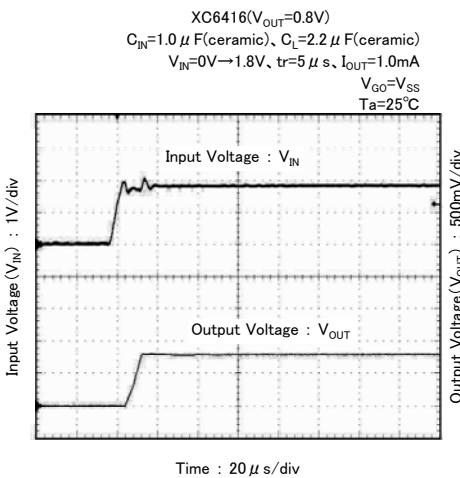

■ TYPICAL PERFORMANCE CHARACTERISTICS (Continued)

(9) Rising Response Time (Continued)

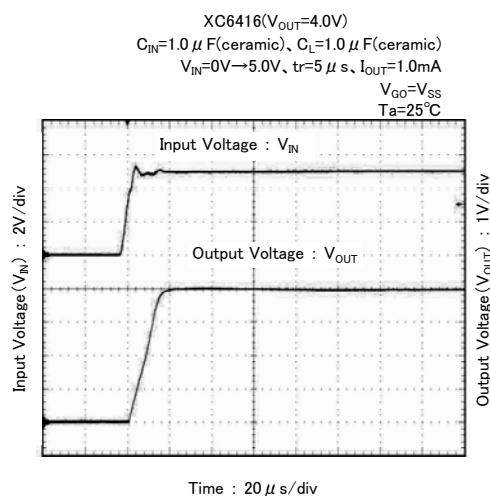
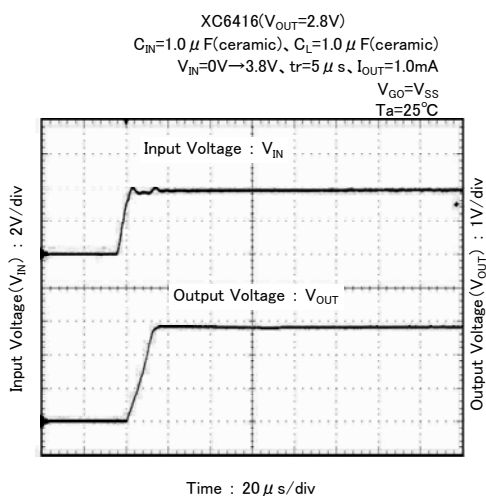

(10) EN Rising Response Time

■ HS mode ($V_{GO}=V_{IN}$)

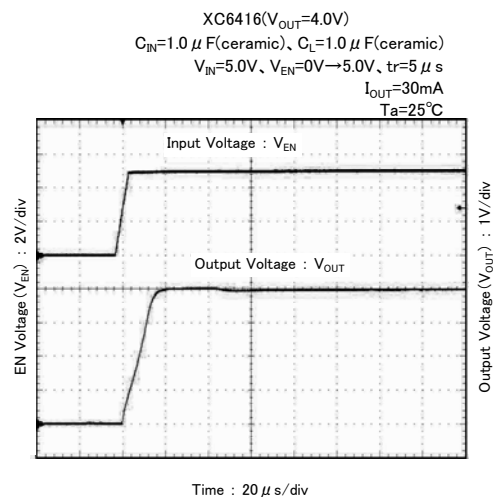
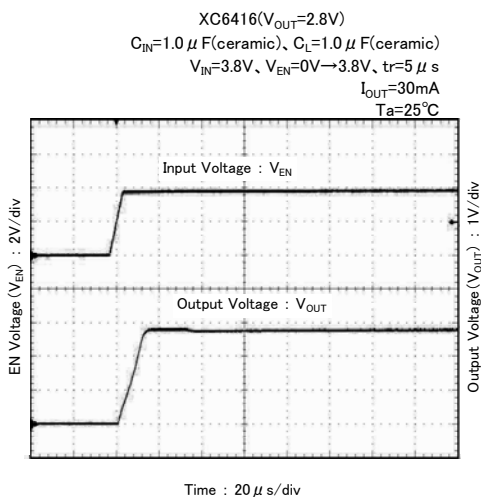
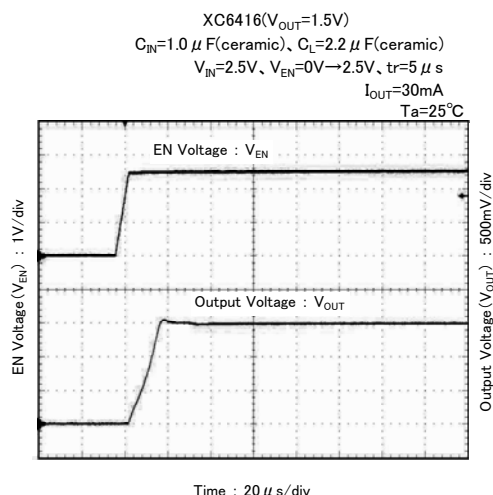
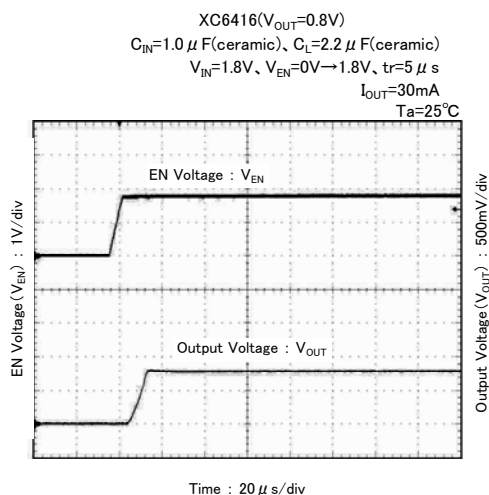

TYPICAL PERFORMANCE CHARACTERISTICS (Continued)

(10) EN Rising Response Time (Continued)

GreenOperation mode ($V_{GO}=V_{SS}$)

XC6416($V_{OUT}=0.8V$)
 $C_{IN}=1.0\mu F$ (ceramic), $C_L=2.2\mu F$ (ceramic)
 $V_{IN}=1.8V$, $V_{EN}=0V\rightarrow 1.8V$, $tr=5\mu s$
 $I_{OUT}=1.0mA$
 $V_{GO}=V_{SS}$
 $T_a=25^\circ C$

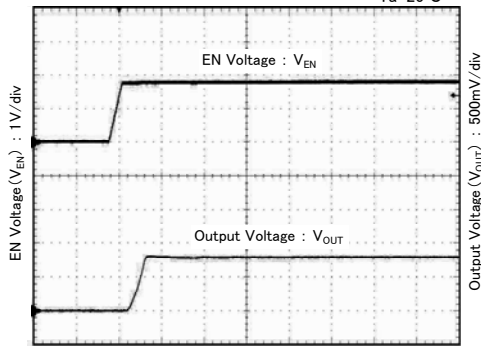

Time : 20 μ s/div

XC6416($V_{OUT}=1.5V$)
 $C_{IN}=1.0\mu F$ (ceramic), $C_L=2.2\mu F$ (ceramic)
 $V_{IN}=2.5V$, $V_{EN}=0V\rightarrow 2.5V$, $tr=5\mu s$
 $I_{OUT}=1.0mA$
 $V_{GO}=V_{SS}$
 $T_a=25^\circ C$

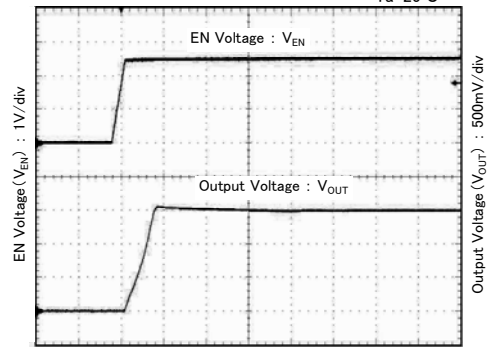

Time : 20 μ s/div

XC6416($V_{OUT}=2.8V$)
 $C_{IN}=1.0\mu F$ (ceramic), $C_L=1.0\mu F$ (ceramic)
 $V_{IN}=3.8V$, $V_{EN}=0V\rightarrow 3.8V$, $tr=5\mu s$
 $I_{OUT}=1.0mA$
 $V_{GO}=V_{SS}$
 $T_a=25^\circ C$

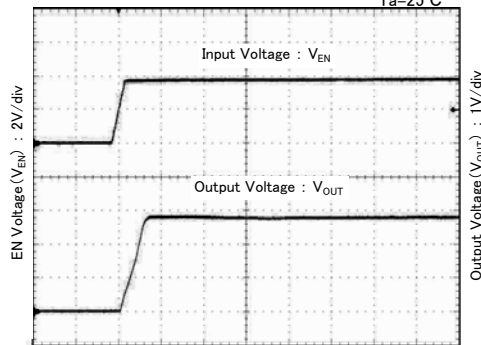

Time : 20 μ s/div

XC6416($V_{OUT}=4.0V$)
 $C_{IN}=1.0\mu F$ (ceramic), $C_L=1.0\mu F$ (ceramic)
 $V_{IN}=5.0V$, $V_{EN}=0V\rightarrow 5.0V$, $tr=5\mu s$
 $I_{OUT}=1.0mA$
 $V_{GO}=V_{SS}$
 $T_a=25^\circ C$

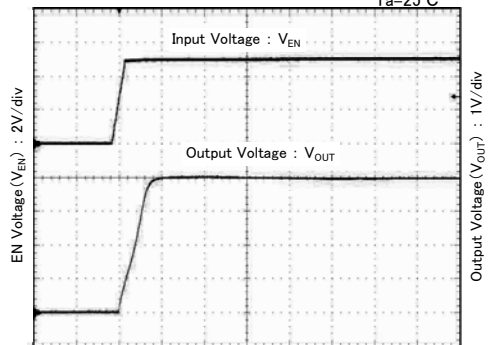

Time : 20 μ s/div

(11) Input Transient Response

HS mode ($V_{GO}=V_{IN}$)

XC6416($V_{OUT}=0.8V$)
 $V_{IN}=1.8V\rightarrow 2.8V$, $tr=tf=5\mu s$, $I_{OUT}=30mA$
 $C_L=2.2\mu F$ (ceramic)
 $T_a=25^\circ C$

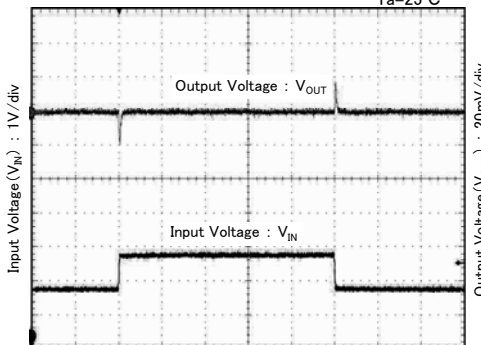

Time : 200 μ s/div

XC6416($V_{OUT}=1.5V$)
 $V_{IN}=2.5V\rightarrow 3.5V$, $tr=tf=5\mu s$, $I_{OUT}=30mA$
 $C_L=2.2\mu F$ (ceramic)
 $T_a=25^\circ C$

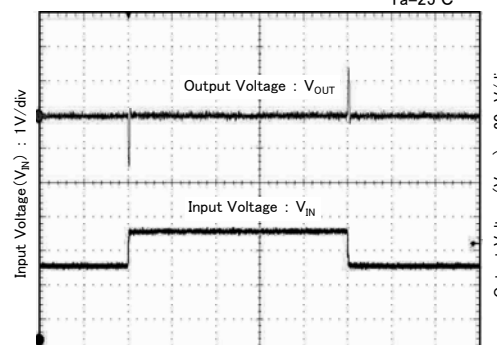

Time : 200 μ s/div

■ TYPICAL PERFORMANCE CHARACTERISTICS (Continued)

(11) Input Transient Response (Continued)

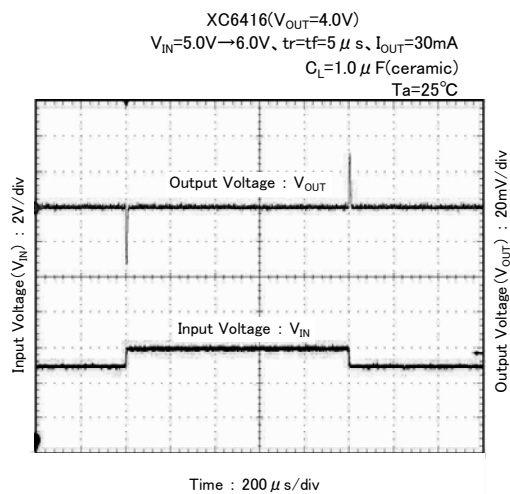
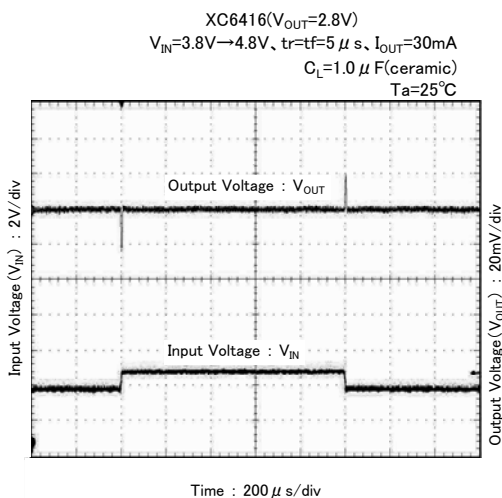

■ GreenOperation mode ($V_{GO}=V_{SS}$)

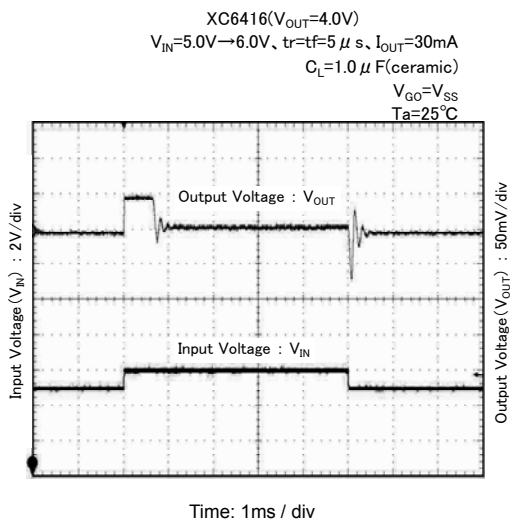
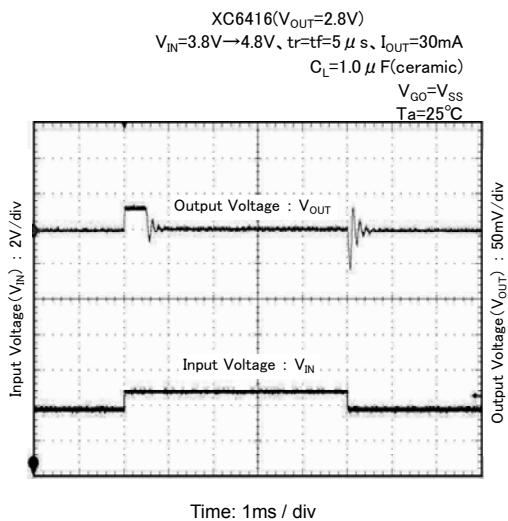
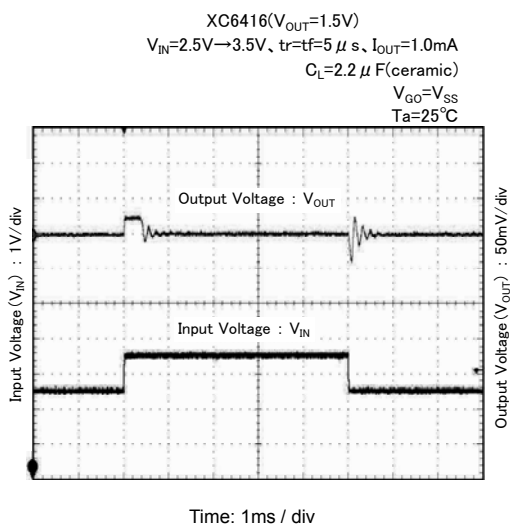
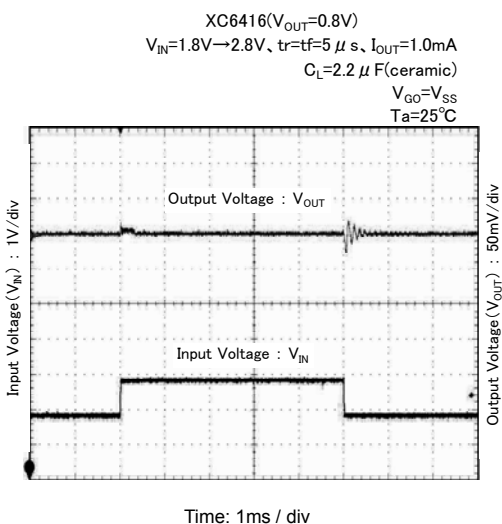

TYPICAL PERFORMANCE CHARACTERISTICS (Continued)

(12) Load Transient Response

■ HS mode ($V_{GO}=V_{IN}$)

XC6416($V_{OUT}=0.8V$)
 $V_{IN}=1.8V$, $I_{OUT}=10mA \leftrightarrow 50mA$, $tr=5 \mu s$
 $C_{IN}=1.0 \mu F$ (ceramic), $C_L=2.2 \mu F$ (ceramic)
 $T_a=25^\circ C$

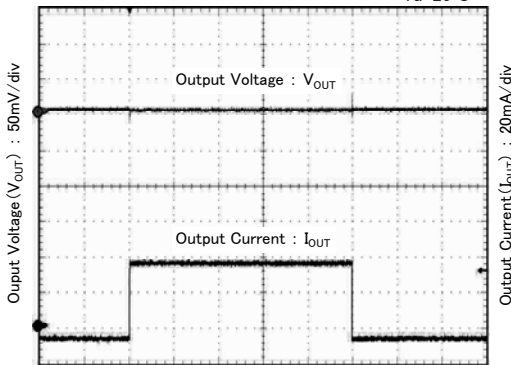

XC6416($V_{OUT}=0.8V$)
 $V_{IN}=1.8V$, $I_{OUT}=10mA \leftrightarrow 50mA$, $tr=5 \mu s$
 $C_{IN}=1.0 \mu F$ (ceramic), $C_L=2.2 \mu F$ (ceramic)
 $T_a=25^\circ C$

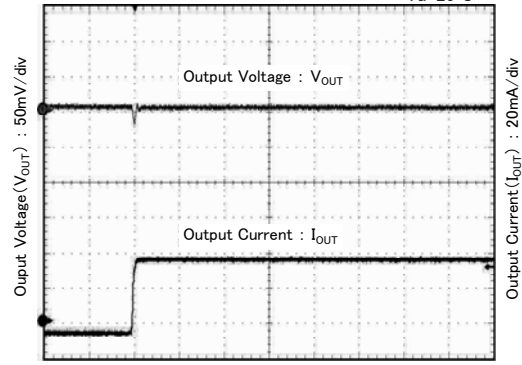

XC6416($V_{OUT}=1.5V$)
 $V_{IN}=2.5V$, $I_{OUT}=10mA \leftrightarrow 50mA$, $tr=5 \mu s$
 $C_{IN}=1.0 \mu F$ (ceramic), $C_L=2.2 \mu F$ (ceramic)
 $T_a=25^\circ C$

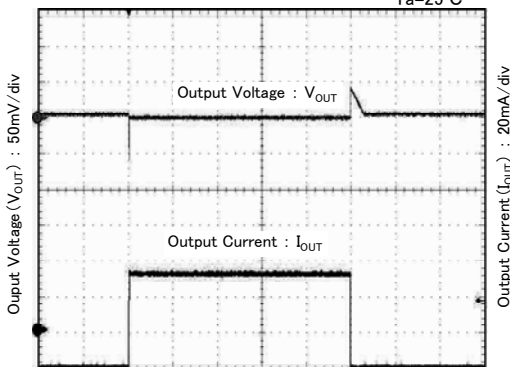

XC6416($V_{OUT}=1.5V$)
 $V_{IN}=2.5V$, $I_{OUT}=10mA \leftrightarrow 50mA$, $tr=5 \mu s$
 $C_{IN}=1.0 \mu F$ (ceramic), $C_L=2.2 \mu F$ (ceramic)
 $T_a=25^\circ C$

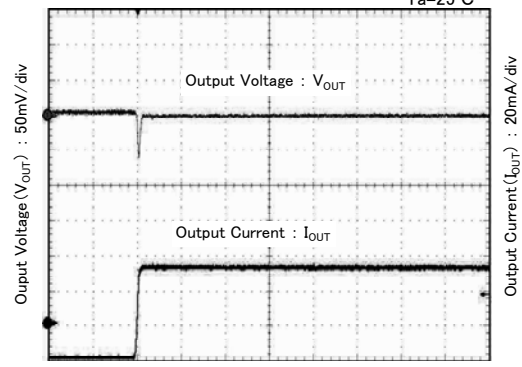

XC6416($V_{OUT}=2.8V$)
 $V_{IN}=3.8V$, $I_{OUT}=10mA \leftrightarrow 50mA$, $tr=5 \mu s$
 $C_{IN}=1.0 \mu F$ (ceramic), $C_L=1.0 \mu F$ (ceramic)
 $T_a=25^\circ C$

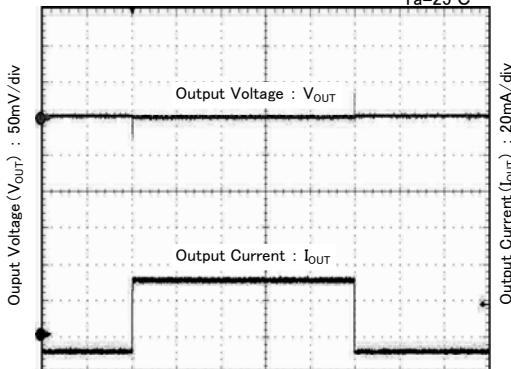

XC6416($V_{OUT}=2.8V$)
 $V_{IN}=3.8V$, $I_{OUT}=10mA \leftrightarrow 50mA$, $tr=5 \mu s$
 $C_{IN}=1.0 \mu F$ (ceramic), $C_L=1.0 \mu F$ (ceramic)
 $T_a=25^\circ C$

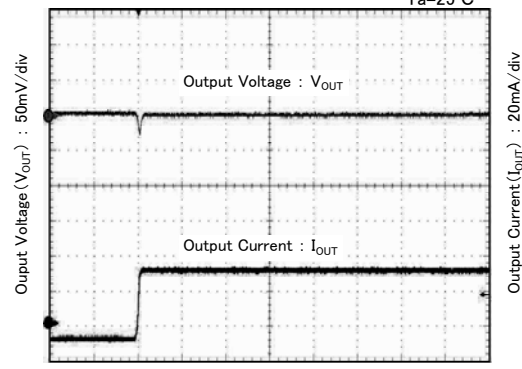

■ TYPICAL PERFORMANCE CHARACTERISTICS (Continued)

(12) Load Transient Response (Continued)

XC6416($V_{OUT}=4.0V$)
 $V_{IN}=5.0V$, $I_{OUT}=10mA \leftrightarrow 50mA$, $tr=tf=5 \mu s$
 $C_{IN}=1.0 \mu F$ (ceramic), $C_L=1.0 \mu F$ (ceramic)
 $T_a=25^\circ C$

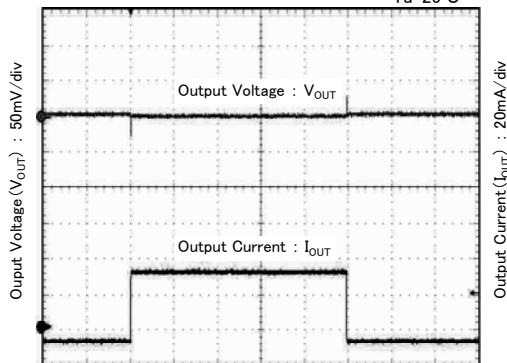

Time : 1ms/div

XC6416($V_{OUT}=4.0V$)
 $V_{IN}=5.0V$, $I_{OUT}=10mA \leftrightarrow 50mA$, $tr=5 \mu s$
 $C_{IN}=1.0 \mu F$ (ceramic), $C_L=1.0 \mu F$ (ceramic)
 $T_a=25^\circ C$

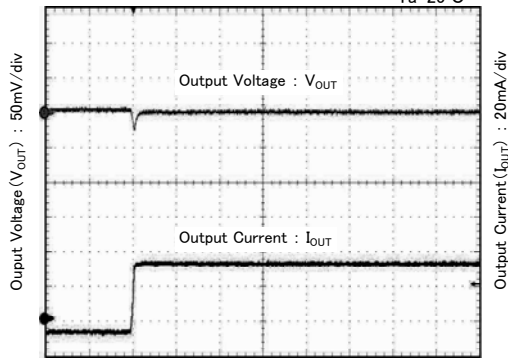

Time : 50 μs /div

■ GO mode ($V_{GO}=V_{SS}$)

XC6416($V_{OUT}=0.8V$)
 $V_{IN}=1.8V$, $I_{OUT}=0.1mA \leftrightarrow 50mA$, $tr=tf=5 \mu s$
 $C_{IN}=1.0 \mu F$ (ceramic), $C_L=2.2 \mu F$ (ceramic)
 $V_{GO}=V_{SS}$
 $T_a=25^\circ C$

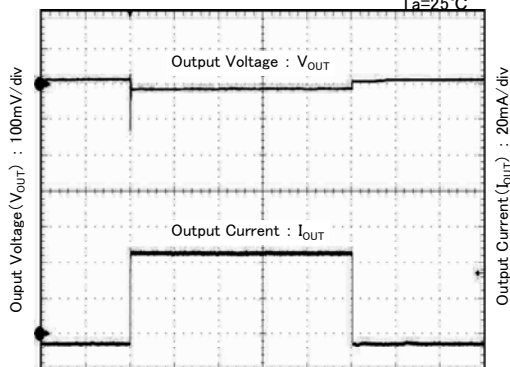

Time : 1ms/div

XC6416($V_{OUT}=0.8V$)
 $V_{IN}=1.8V$, $I_{OUT}=0.1mA \leftrightarrow 50mA$, $tr=tf=5 \mu s$
 $C_{IN}=1.0 \mu F$ (ceramic), $C_L=2.2 \mu F$ (ceramic)
 $V_{GO}=V_{SS}$
 $T_a=25^\circ C$

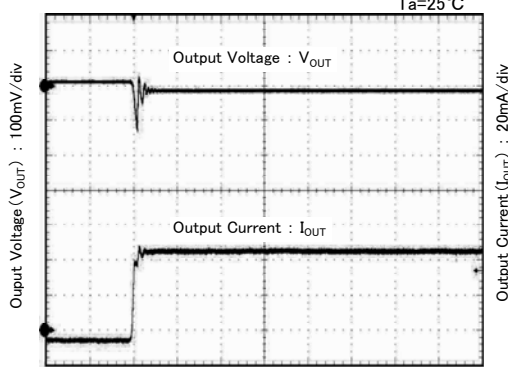

Time : 50 μs /div

XC6416($V_{OUT}=1.5V$)
 $V_{IN}=2.5V$, $I_{OUT}=0.1mA \leftrightarrow 50mA$, $tr=tf=5 \mu s$
 $C_{IN}=1.0 \mu F$ (ceramic), $C_L=2.2 \mu F$ (ceramic)
 $V_{GO}=V_{SS}$
 $T_a=25^\circ C$

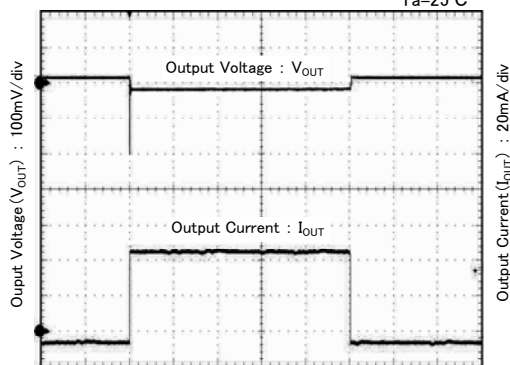

Time : 1ms/div

XC6416($V_{OUT}=1.5V$)
 $V_{IN}=2.5V$, $I_{OUT}=0.1mA \leftrightarrow 50mA$, $tr=tf=5 \mu s$
 $C_{IN}=1.0 \mu F$ (ceramic), $C_L=2.2 \mu F$ (ceramic)
 $V_{GO}=V_{SS}$
 $T_a=25^\circ C$

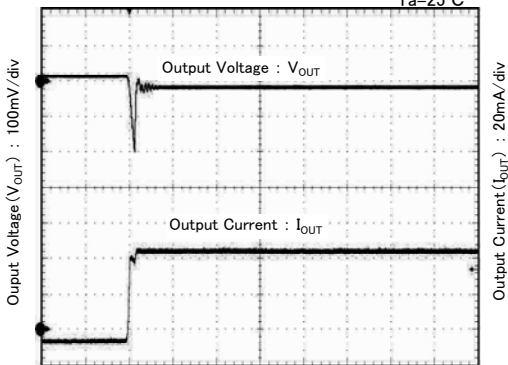

Time : 50 μs /div

TYPICAL PERFORMANCE CHARACTERISTICS (Continued)

(12) Load Transient Response (Continued)

XC6416($V_{OUT}=2.8V$)
 $V_{IN}=3.8V$, $I_{OUT}=0.1mA \leftrightarrow 50mA$, $t_r=t_f=5 \mu s$
 $C_{IN}=1.0 \mu F$ (ceramic), $C_L=1.0 \mu F$ (ceramic)
 $V_{GO}=V_{SS}$
 $T_a=25^\circ C$

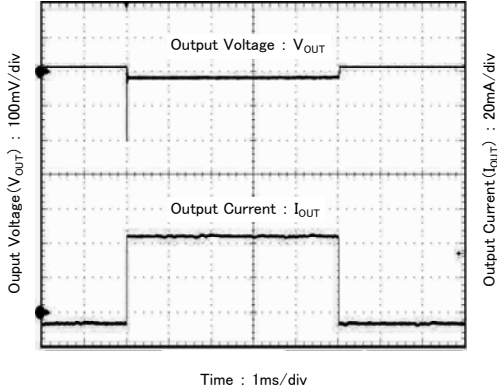

XC6416($V_{OUT}=2.8V$)
 $V_{IN}=3.8V$, $I_{OUT}=0.1mA \leftrightarrow 50mA$, $t_r=t_f=5 \mu s$
 $C_{IN}=1.0 \mu F$ (ceramic), $C_L=1.0 \mu F$ (ceramic)
 $V_{GO}=V_{SS}$
 $T_a=25^\circ C$

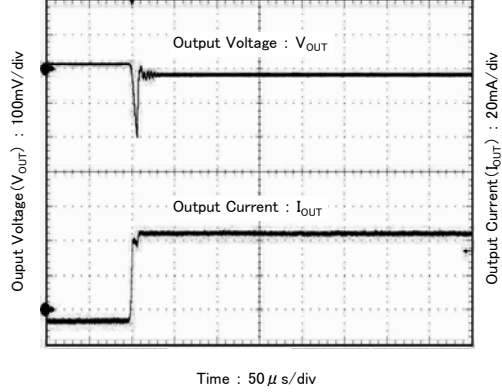

XC6416($V_{OUT}=4.0V$)
 $V_{IN}=5.0V$, $I_{OUT}=0.1mA \leftrightarrow 50mA$, $t_r=t_f=5 \mu s$
 $C_{IN}=1.0 \mu F$ (ceramic), $C_L=1.0 \mu F$ (ceramic)
 $V_{GO}=V_{SS}$
 $T_a=25^\circ C$

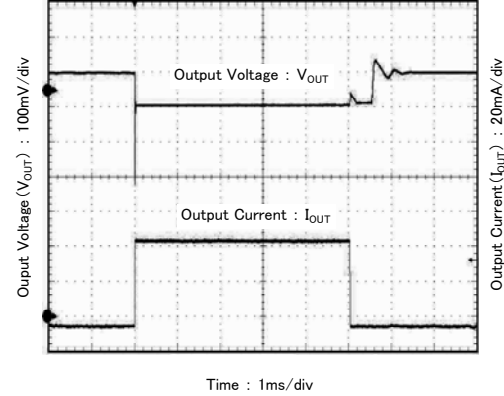

XC6416($V_{OUT}=4.0V$)
 $V_{IN}=5.0V$, $I_{OUT}=0.1mA \leftrightarrow 50mA$, $t_r=t_f=5 \mu s$
 $C_{IN}=1.0 \mu F$ (ceramic), $C_L=1.0 \mu F$ (ceramic)
 $V_{GO}=V_{SS}$
 $T_a=25^\circ C$

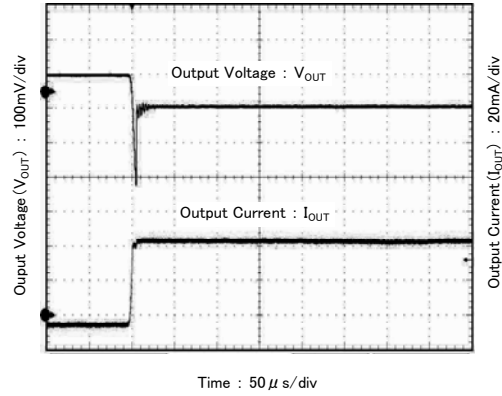

(13) Ripple Rejection Rate

XC6416($V_{OUT}=0.8V$)
 $V_{IN}=1.8V+0.5V_{p-p AC}$, $I_{OUT}=30mA$
 $C_L=2.2 \mu F$ (ceramic)
 $T_a=25^\circ C$

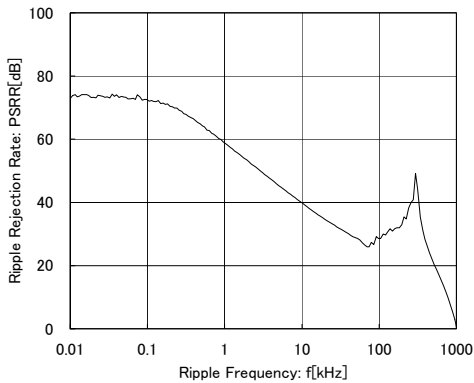

XC6416($V_{OUT}=1.5V$)
 $V_{IN}=2.5V+0.5V_{p-p AC}$, $I_{OUT}=30mA$
 $C_L=2.2 \mu F$ (ceramic)
 $T_a=25^\circ C$

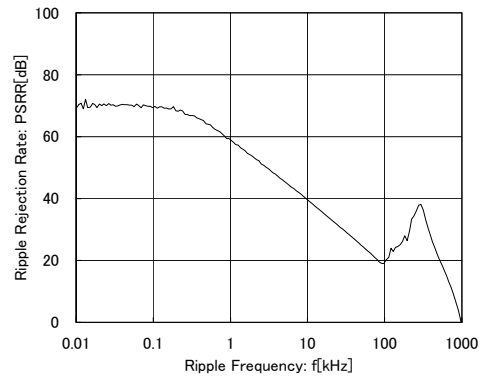

■ TYPICAL PERFORMANCE CHARACTERISTICS (Continued)

(13) Ripple Rejection Rate (Continued)

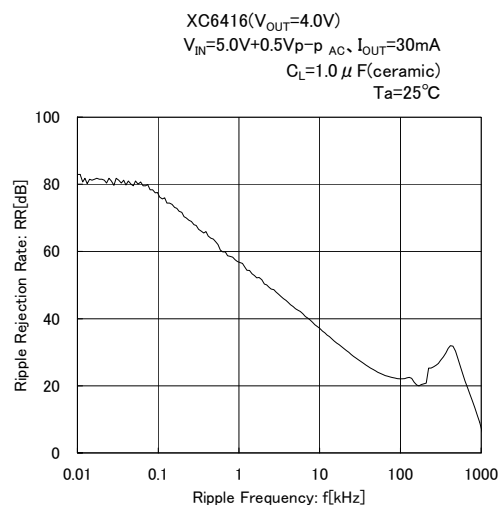
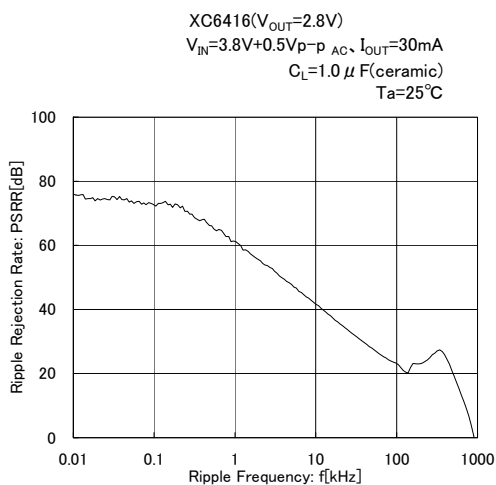

(14) Cross Talk

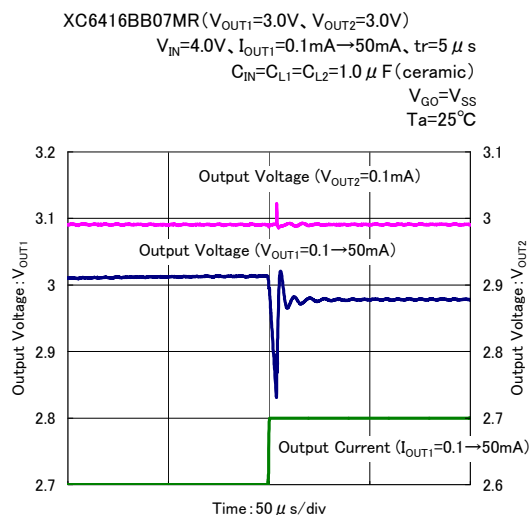
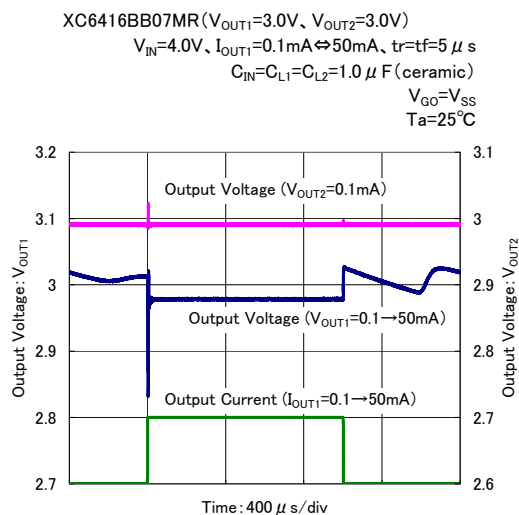
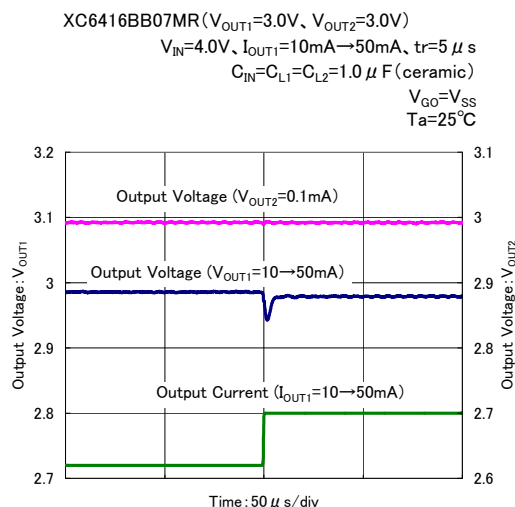
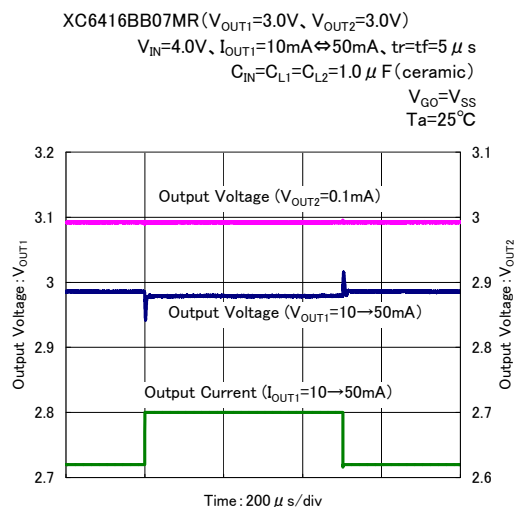

PACKAGING INFORMATION

● SOT-26

Unit mm

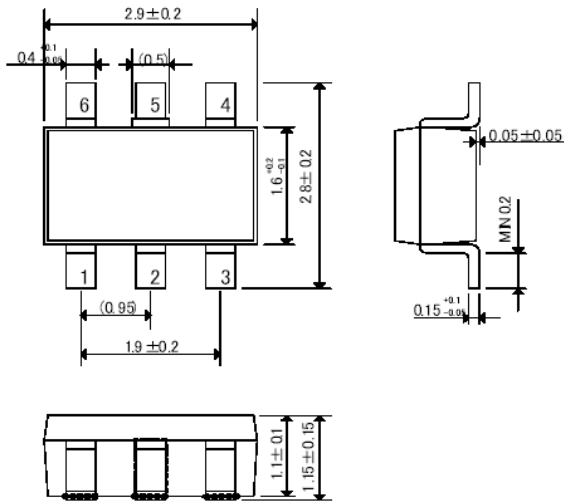

● USP-6C

Unit mm

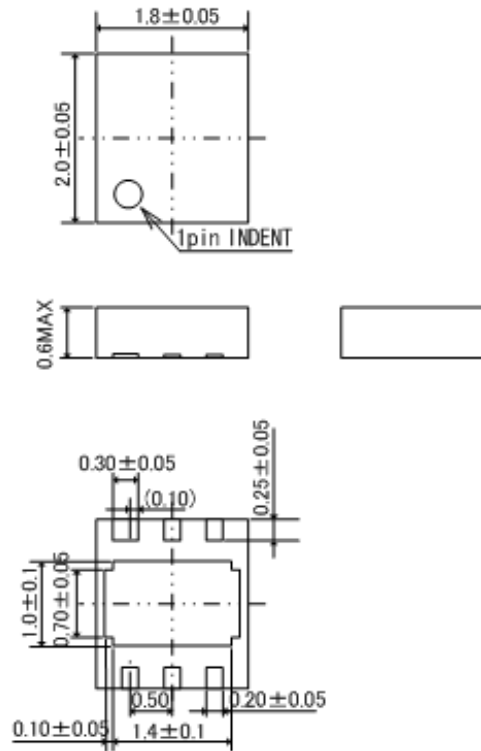

● USP-6C Reference Pattern Layout

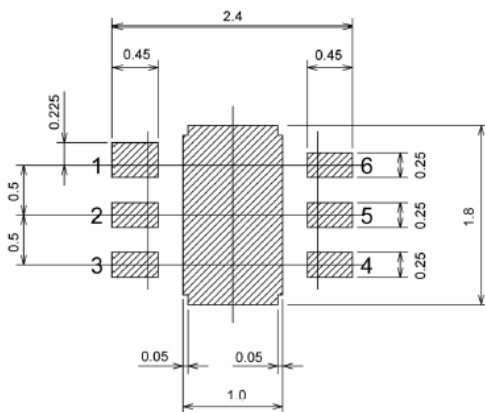

● USP-6C Reference Metal Mask Design

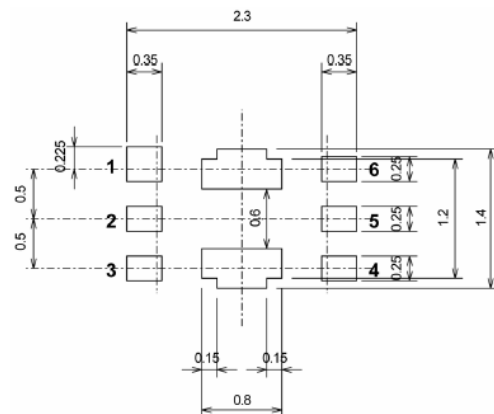

■ PACKAGING INFORMATION (Continued)

● USP-6C Power Dissipation

Power dissipation data for the USP-6C is shown in this page.
The value of power dissipation varies with the mount board conditions.
Please use this data as one of reference data taken in the described condition.

1. Measurement Condition (Reference data)

- Condition: Mount on a board
- Ambient: Natural convection
- Soldering: Lead (Pb) free
- Board: Dimensions 40 x 40 mm (1600 mm² in one side)
Copper (Cu) traces occupy 50% of the board area
In top and back faces
Package heat-sink is tied to the copper traces
- Material: Glass Epoxy (FR-4)
- Thickness: 1.6 mm
- Through-hole: 4 x 0.8 Diameter

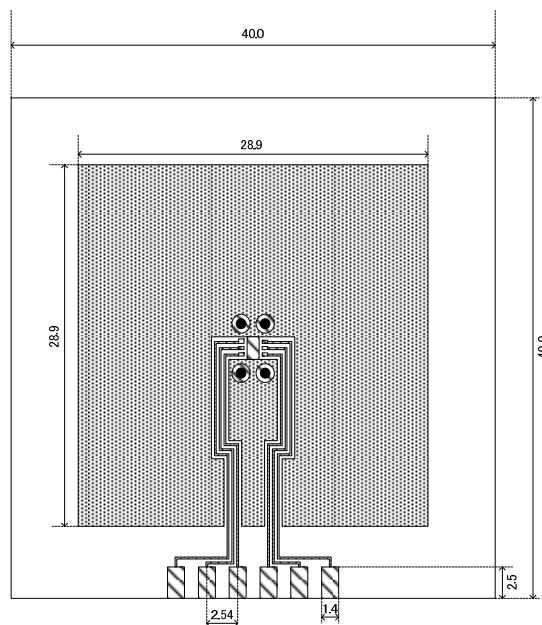

Evaluation Board (Unit: mm)

2. Power Dissipation vs. Ambient Temperature

Board Mount ($T_j \text{ max} = 125^\circ\text{C}$)

Ambient Temperature ($^\circ\text{C}$)	Power Dissipation Pd (mW)	Thermal Resistance ($^\circ\text{C}/\text{W}$)
25	1000	100
85	400	

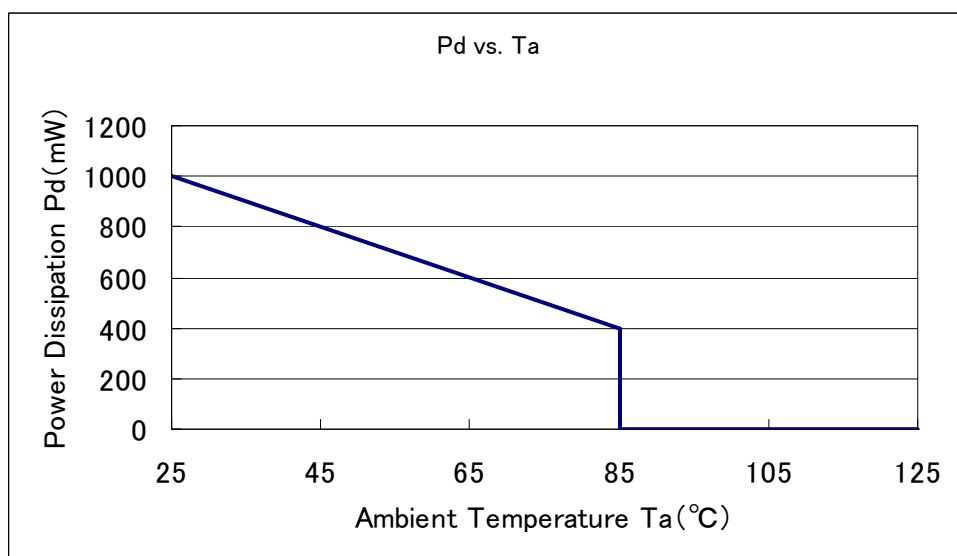

1. The products and product specifications contained herein are subject to change without notice to improve performance characteristics. Consult us, or our representatives before use, to confirm that the information in this datasheet is up to date.
2. We assume no responsibility for any infringement of patents, patent rights, or other rights arising from the use of any information and circuitry in this datasheet.
3. Please ensure suitable shipping controls (including fail-safe designs and aging protection) are in force for equipment employing products listed in this datasheet.
4. The products in this datasheet are not developed, designed, or approved for use with such equipment whose failure or malfunction can be reasonably expected to directly endanger the life of, or cause significant injury to, the user.
(e.g. Atomic energy; aerospace; transport; combustion and associated safety equipment thereof.)
5. Please use the products listed in this datasheet within the specified ranges.
Should you wish to use the products under conditions exceeding the specifications, please consult us or our representatives.
6. We assume no responsibility for damage or loss due to abnormal use.
7. All rights reserved. No part of this datasheet may be copied or reproduced without the prior permission of TOREX SEMICONDUCTOR LTD.

TOREX SEMICONDUCTOR LTD.