

REV.	DATE	DESCRIPTION
NC	04/29/99	INITIAL RELEASE
A	05/08/07	REVISE BARREL, FERRULE DIMS, UPDATE DRAWING FORMAT

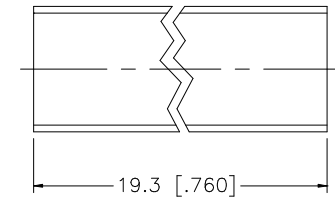
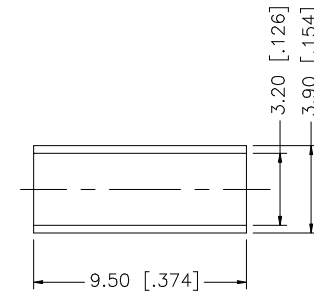
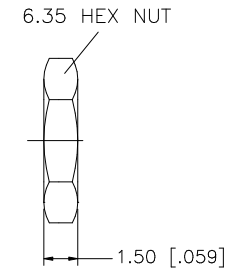
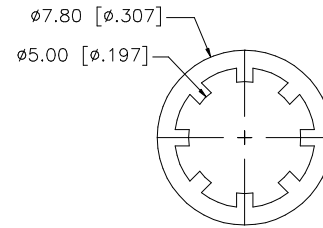
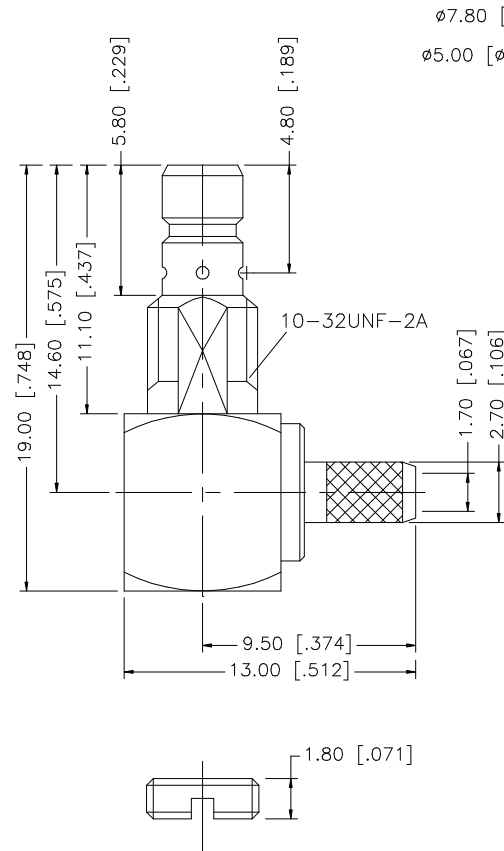
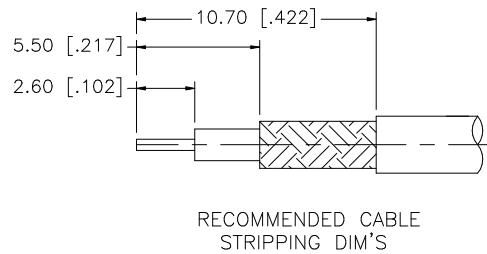
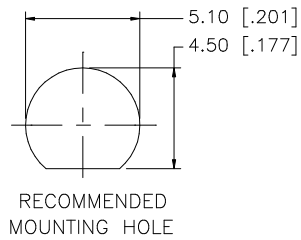

NOTE:

1. CRIMPED FERRULE HEX CRIMP SIZE .128"
2. CONTACT PIN TO SOLDER.

QTY	FINISH	MATERIAL	DESCRIPTION
1	GOLD	BRASS	BODY
1	NATURAL	TEFLON	INSULATOR
1	GOLD	BRASS	CONTACT PIN
1	GOLD	BRASS	LOCK WASHER
1	GOLD	BRASS	HEX NUT
1	GOLD	COPPER	FERRULE
1	GOLD	BRASS	COVER

UNLESS OTHERWISE SPECIFIED DIMENSIONS ARE IN MILLIMETERS. DIMENSIONS IN [] ARE IN INCHES AND FOR CUSTOMER REFERENCE ONLY.

UNLESS OTHERWISE SPECIFIED TOLERANCES FOR MILLIMETERS ARE:
0.5 - 8mm ± 0.20mm
8 - 30mm ± 0.40mm
30 - 120mm ± 0.50mm

UNLESS OTHERWISE SPECIFIED TOLERANCES FOR INCHES ARE:
.020 - .315 = ± 0.007"
.315 - 1.180 = ± 0.015"
1.180 - 4.724 = ± 0.020"

DO NOT SCALE DRAWING

APPROVALS	DATE
DRAWN G.R.S.	05/08/07
CHECKED	
ISSUED	
SHEET 1 OF 1	
CAD FILE	C:/142/142233.DWG

<h1>Amphenol Connex</h1>			
PART DESCRIPTION			
SMB R/A BULKHEAD CRIMP JACK (FOR RG-174/U, 188A/U, 316/U)			
PART NO.			
142233			
DWG. NO.	142233.DWG	REV.	A
SIZE	A	SCALE	NA

Mouser Electronics

Authorized Distributor

Click to View Pricing, Inventory, Delivery & Lifecycle Information:

[Amphenol:](#)

[142233](#)