

Aluminum electrolytic capacitors

Axial-lead and soldering star capacitors

Series/Type: B41693, B41793

Date: November 2012

© EPCOS AG 2015. Reproduction, publication and dissemination of this publication, enclosures hereto and the information contained therein without EPCOS' prior express consent is prohibited.

EPCOS AG is a TDK Group Company.

Applications

- Automotive electronics

Features

- High operating temperature capability up to 150 °C
- Rated voltage up to 100 V DC
- Low ESR
- High reliability
- Outstanding parametric stability
- High ripple current capability
- High vibration stability
- Long useful life
- Shelf life up to 15 years at storage temperatures up to 40 °C.
To ensure solderability, the capacitors should be built into the application within one year of delivery. After a total of two years' storage, the operating voltage must be applied for one hour to ensure the specified leakage current.
- RoHS-compatible

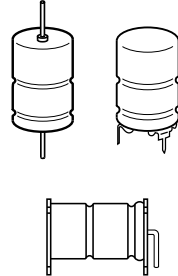

Construction

- Charge/discharge-proof, polar
- Aluminum case with insulating sleeve
- Negative pole connected to case

Terminals

- Axial leads, welded to ensure perfect electrical contact
- Soldering star for upright mounting on PCB available
- Alternative axial-lead design with double-sided plates for horizontal mounting available upon request

Taping and Packing

- Axial-lead capacitors will be delivered in pallet package
Capacitors with $d \times l \leq 16 \times 30$ mm are also available taped on reel
- Soldering star capacitors are packed in cardboard

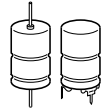
Specifications and characteristics in brief

| | | | | | | | |
|---|--|---|--|----|----|-------|----|
| Rated voltage V_R | 25 ... 100 V DC | | | | | | |
| Surge voltage V_S | $1.15 \cdot V_R$ | | | | | | |
| Rated capacitance C_R | 100 ... 4000 μF | | | | | | |
| Capacitance tolerance | $-10/+30\% \triangle Q$ | | | | | | |
| Leakage current I_{leak} (5 min, 20 °C) | $I_{\text{leak}} \leq 0.006 \mu\text{A} \cdot \left(\frac{C_R}{\mu\text{F}} \cdot \frac{V_R}{V} \right) + 4 \mu\text{A}$ | | | | | | |
| Self-inductance ESL ¹⁾ | Diameter d (mm) | 12 | 14 | 16 | 18 | 20/21 | |
| | Terminals | Length l (mm) | Approx. ESL (nH) | | | | |
| | axial | 25 | – | 22 | – | 30 | – |
| | | 29 | – | – | – | – | 38 |
| | | 30 | 21 | 24 | 29 | 34 | – |
| | | 35 | – | – | 31 | – | – |
| | | 39 | – | – | 33 | 38 | 45 |
| | | 49 | – | – | – | – | 50 |
| | soldering star | 25 | – | 6 | – | 8 | – |
| | | 30 | 6 | 7 | 8 | 10 | – |
| | | 35 | – | – | 9 | – | – |
| | | 39 | – | – | 9 | 11 | 13 |
| 49 | | – | – | – | – | 14 | |
| Useful life ²⁾ 150 °C; V_R ; $0.5 \cdot I_{AC,R}$ 125 °C; V_R ; $I_{AC,R}$ 85 °C; V_R ; $I_{AC,max}$ 40 °C; V_R ; $2.1 \cdot I_{AC,R}$ | > 1000 h | | Requirements: | | | | |
| | > 5000 h | | $\Delta C/C \leq \pm 30\%$ of initial value | | | | |
| | > 15000 h | | ESR ≤ 3 times initial specified limit ³⁾ | | | | |
| | > 200000 h | | $I_{\text{leak}} \leq$ initial specified limit | | | | |
| Voltage endurance test 125 °C; V_R | 2000 h | | Post test requirements: | | | | |
| | | | $\Delta C/C \leq \pm 10\%$ of initial value | | | | |
| | | ESR $\leq 1.3\%$ of initial specified limit ³⁾ | | | | | |
| | | $I_{\text{leak}} \leq$ initial specified limit | | | | | |
| Vibration resistance test | To IEC 60068-2-6, test Fc: Frequency range 10 Hz ... 2 kHz, displacement amplitude max. 1.5 mm, acceleration max. 20 g, duration 3×2 h. Capacitor mounted by its wire leads at a distance of (6 ± 1) mm from the case and additionally clamped by the case. | | | | | | |
| IEC climatic category | To IEC 60068-1: 55/125/56 (-55 °C/ $+125$ °C/56 days damp heat test) | | | | | | |
| Detail specification | Similar to CECC 30301-802 | | | | | | |
| Sectional specification | IEC 60384-4 | | | | | | |

1) If optimum circuit design is used, the values are lower by 30%.

2) Refer to chapter "General technical information, 5 Useful life" on how to interpret useful life.

3) ESR_{max} at 100 Hz, 20 °C



B41693, B41793

High reliability – up to 150 °C

B41693, Axial-lead capacitors

Dimensional drawing

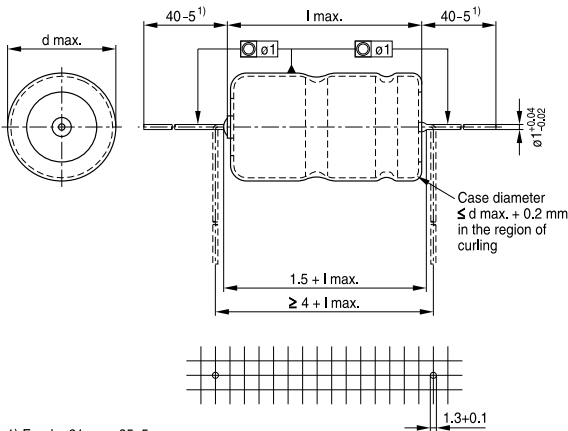

1) For d = 21 mm: 35-5

KAL1374-L

Dimensions, weights and packing units

| d × l mm | d _{max} × l _{max} mm | Approx. weight g | Packing units (pcs.) | |
|-------------|---|---------------------|----------------------|------|
| | | | Pallet | Reel |
| 12 × 30 | 12.5 × 30.5 | 5.1 | 288 | 450 |
| 14 × 25 | 14.5 × 25.5 | 5.7 | 200 | 350 |
| 14 × 30 | 14.5 × 30.5 | 6.8 | 200 | 350 |
| 16 × 30 | 16.5 × 30.5 | 8.9 | 180 | 250 |
| 16 × 35 | 16.5 × 35.5 | 10.4 | 180 | — |
| 16 × 39 | 16.5 × 40 | 11.7 | 180 | — |
| 18 × 25 | 18.5 × 25.5 | 9.3 | 160 | — |
| 18 × 30 | 18.5 × 30.5 | 11.1 | 160 | — |
| 18 × 39 | 18.5 × 40 | 14.7 | 160 | — |
| 20 × 29 | 20.5 × 29.5 | 13.5 | 140 | — |
| 21 × 39 | 21.5 × 40 | 20.0 | 140 | — |
| 21 × 49 | 21.5 × 50 | 25.0 | 110 | — |

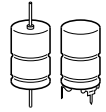
B41793, Soldering star capacitors
Dimensional drawings

 Mounting holes $d = 12 \text{ mm} \dots 14 \text{ mm}$

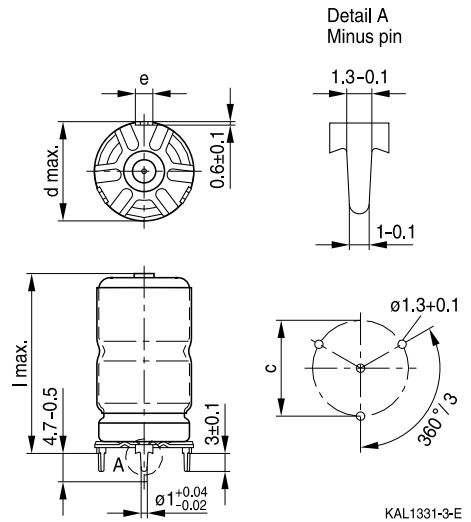
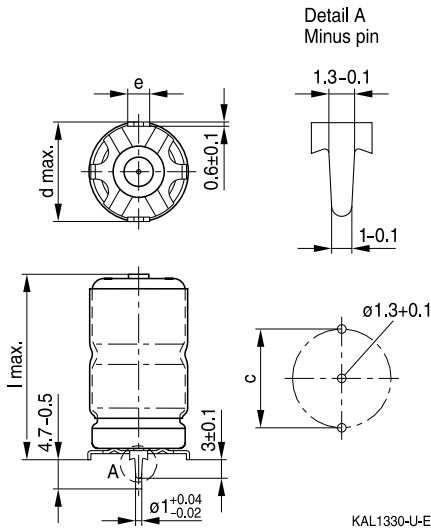
 Mounting holes $d = 16 \text{ mm} \dots 21 \text{ mm}$

Dimensions, weights and packing units

| $d \times l$ mm | $d_{\max} \times l_{\max}$ mm | $c \pm 0.1$ mm | $e \pm 0.1$ mm | Approx. weight g | Packing units pcs. |
|--------------------|----------------------------------|-------------------|-------------------|---------------------|-----------------------|
| 12 × 30 | 13.5 × 32 | 12.5 | 3.0 | 5.4 | 480 |
| 14 × 25 | 15.5 × 27 | 14.5 | 3.0 | 6.1 | 480 |
| 14 × 30 | 15.5 × 32 | 14.5 | 3.0 | 7.2 | 480 |
| 16 × 30 | 17.5 × 32 | 16.5 | 3.0 | 9.4 | 300 |
| 16 × 35 | 17.5 × 37 | 16.5 | 3.0 | 10.9 | 200 |
| 16 × 39 | 17.5 × 41.5 | 16.5 | 3.0 | 12.2 | 200 |
| 18 × 25 | 19.5 × 27 | 18.5 | 3.0 | 9.9 | 300 |
| 18 × 30 | 19.5 × 32 | 18.5 | 3.0 | 11.8 | 300 |
| 18 × 39 | 19.5 × 41.5 | 18.5 | 3.0 | 15.4 | 200 |
| 21 × 39 | 22.5 × 41.5 | 21.5 | 3.5 | 21.0 | 324 |
| 21 × 49 | 22.5 × 51.5 | 21.5 | 3.5 | 26.0 | 264 |



B41693, B41793

High reliability – up to 150 °C

Overview of available types

| V_R (V DC) | 25 | 40 | 63 | 75 | 100 |
|-------------------|-----------------------------------|--------------------|--------------------|--------------------|--------------------|
| | Case dimensions $d \times l$ (mm) | | | | |
| C_R (μF) | | | | | |
| 100 | | | 12 × 30 | 12 × 30 | 12 × 30 |
| 150 | | | | | 14 × 30 |
| 220 | | | 14 × 30 | 16 × 30 | 16 × 30 |
| 330 | | 12 × 30 | 16 × 30 18 × 25 | 16 × 35 | |
| 470 | 14 × 25 | 14 × 30 | 16 × 39 | 18 × 39 20 × 29 | 18 × 39 20 × 29 |
| 560 | | | 20 × 29 | | |
| 680 | | 16 × 30 18 × 25 | 18 × 39 | 21 × 39 | 21 × 39 |
| 820 | | 16 × 35 | | | |
| 1000 | 16 × 30 18 × 25 | 16 × 39 18 × 30 | 21 × 39 | 21 × 49 | 21 × 49 |
| 1200 | | 20 × 29 | 21 × 49 | | |
| 1500 | 16 × 39 | 18 × 39 | | | |
| 1800 | 20 × 29 | | | | |
| 2000 | 18 × 39 | | | | |
| 2200 | | 21 × 39 | | | |
| 2700 | | 21 × 49 | | | |
| 3000 | 21 × 39 | | | | |
| 4000 | 21 × 49 | | | | |

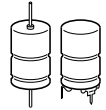
Case dimensions and ordering codes

| V_R | C_R | Case dimensions $d \times l$ mm | Ordering code Axial pallet | Ordering code Axial reel | Ordering code Soldering star | |
|-------|--------|---------------------------------------|-------------------------------|-----------------------------|---------------------------------|-----------------|
| 25 | 100 Hz | 14 × 25 | B41693A5477Q001 | B41693A5477Q003 | B41793A5477Q001 | |
| | 20 °C | 16 × 30 | B41693A5108Q001 | B41693A5108Q003 | B41793A5108Q001 | |
| | V DC | 1000 | 18 × 25 | B41693B5108Q001 | | B41793B5108Q001 |
| | | 1500 | 16 × 39 | B41693A5158Q001 | | B41793A5158Q001 |
| | | 1800 | 20 × 29 | B41693A5188Q001 | | |
| | | 2000 | 18 × 39 | B41693A5208Q001 | | B41793A5208Q001 |
| | | 3000 | 21 × 39 | B41693A5308Q001 | | B41793A5308Q001 |
| | | 4000 | 21 × 49 | B41693A5408Q001 | | B41793A5408Q001 |
| 40 | 330 | 12 × 30 | B41693A7337Q001 | B41693A7337Q003 | B41793A7337Q001 | |
| | 470 | 14 × 30 | B41693A7477Q001 | B41693A7477Q003 | B41793A7477Q001 | |
| | 680 | 16 × 30 | B41693A7687Q001 | B41693A7687Q003 | B41793A7687Q001 | |
| | 680 | 18 × 25 | B41693B7687Q001 | | B41793B7687Q001 | |
| | 820 | 16 × 35 | B41693A7827Q001 | | B41793A7827Q001 | |
| | 1000 | 16 × 39 | B41693B7108Q001 | | B41793B7108Q001 | |
| | 1000 | 18 × 30 | B41693A7108Q001 | | B41793A7108Q001 | |
| | 1200 | 20 × 29 | B41693A7128Q001 | | | |
| | 1500 | 18 × 39 | B41693A7158Q001 | | B41793A7158Q001 | |
| | 2200 | 21 × 39 | B41693A7228Q001 | | B41793A7228Q001 | |
| | 2700 | 21 × 49 | B41693A7278Q001 | | B41793A7278Q001 | |
| | 63 | 100 | 12 × 30 | B41693A8107Q001 | B41693A8107Q003 | B41793A8107Q001 |
| | | 220 | 14 × 30 | B41693A8227Q001 | B41693A8227Q003 | B41793A8227Q001 |
| 330 | | 16 × 30 | B41693A8337Q001 | B41693A8337Q003 | B41793A8337Q001 | |
| 330 | | 18 × 25 | B41693B8337Q001 | | B41793B8337Q001 | |
| 470 | | 16 × 39 | B41693A8477Q001 | | B41793A8477Q001 | |
| 560 | | 20 × 29 | B41693A8567Q001 | | | |
| 680 | | 18 × 39 | B41693A8687Q001 | | B41793A8687Q001 | |
| 1000 | | 21 × 39 | B41693A8108Q001 | | B41793A8108Q001 | |
| 1200 | | 21 × 49 | B41693A8128Q001 | | B41793A8128Q001 | |

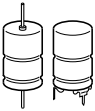
B41693, B41793
High reliability – up to 150 °C

| V_R | C_R 100 Hz 20 °C | Case dimensions d × l mm | Ordering code Axial pallet | Ordering code Axial reel | Ordering code Soldering star | |
|-------|--------------------------|-----------------------------------|-------------------------------|-----------------------------|---------------------------------|-----------------|
| V DC | μF | | | | | |
| 75 | 100 | 12 × 30 | B41693A0107Q001 | B41693A0107Q003 | B41793A0107Q001 | |
| | 220 | 16 × 30 | B41693A0227Q001 | | B41793A0227Q001 | |
| | 330 | 16 × 35 | B41693A0337Q001 | | B41793A0337Q001 | |
| | 470 | 18 × 39 | B41693A0477Q001 | | B41793A0477Q001 | |
| | 470 | 20 × 29 | B41693B0477Q001 | | | |
| | 680 | 21 × 39 | B41693A0687Q001 | | B41793A0687Q001 | |
| | 1000 | 21 × 49 | B41693A0108Q001 | | B41793A0108Q001 | |
| 100 | 100 | 12 × 30 | B41693B9107Q001 | B41693B9107Q003 | B41793B9107Q001 | |
| | 150 | 14 × 30 | B41693B9157Q001 | B41693B9157Q003 | B41793B9157Q001 | |
| | 220 | 16 × 30 | B41693A9227Q001 | B41693A9227Q003 | B41793A9227Q001 | |
| | 470 | 18 × 39 | B41693A9477Q001 | | B41793A9477Q001 | |
| | 470 | 20 × 29 | B41693B9477Q001 | | | |
| | 680 | 21 × 39 | B41693A9687Q001 | | B41793A9687Q001 | |
| | 1000 | 21 × 49 | B41693A9108Q001 | | | B41793A9108Q001 |

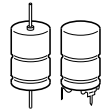
Technical data

| C_R | Case dimensions | ESR_{max} 100 Hz 20 °C | ESR_{max} 100 Hz -40 °C | ESR_{max} 10 kHz 20 °C | Z_{max} 100 kHz 20 °C | $I_{AC,max}$ 10 kHz 105 °C | $I_{AC,max}$ 10 kHz 125 °C | $I_{AC,R}$ 10 kHz 125 °C | $I_{AC,max}$ 10 kHz 150 °C |
|-----------------------------------|-----------------|--------------------------------|---------------------------------|--------------------------------|-------------------------------|----------------------------------|----------------------------------|--------------------------------|----------------------------------|
| μF | mm | m Ω | m Ω | m Ω | m Ω | A | A | A | A |
| $V_R = 25 V DC$ | | | | | | | | | |
| 470 | 14 × 25 | 260 | 1900 | 140 | 102 | 3.6 | 2.8 | 1.95 | 1.0 |
| 1000 | 16 × 30 | 130 | 900 | 75 | 55 | 5.3 | 4.2 | 2.9 | 1.4 |
| 1000 | 18 × 25 | 120 | 900 | 70 | 50 | 5.8 | 4.6 | 3.15 | 1.6 |
| 1500 | 16 × 39 | 85 | 600 | 50 | 39 | 7.4 | 5.8 | 4.0 | 2.0 |
| 1800 | 20 × 29 | 70 | 600 | 40 | 30 | 8.2 | 6.4 | 4.45 | 2.2 |
| 2000 | 18 × 39 | 70 | 500 | 42 | 26 | 7.9 | 6.2 | 4.3 | 4.1 |
| 3000 | 21 × 39 | 43 | 450 | 25 | 21 | 11.8 | 9.2 | 6.4 | 3.2 |
| 4000 | 21 × 49 | 33 | 320 | 20 | 16 | 14.9 | 11.7 | 8.0 | 4.0 |
| $V_R = 40 V DC$ | | | | | | | | | |
| 330 | 12 × 30 | 320 | 2500 | 150 | 140 | 3.7 | 2.9 | 2.0 | 1.0 |
| 470 | 14 × 30 | 220 | 1700 | 110 | 102 | 4.5 | 3.5 | 2.45 | 1.2 |
| 680 | 16 × 30 | 160 | 1200 | 80 | 75 | 5.2 | 4.1 | 2.85 | 1.4 |
| 680 | 18 × 25 | 150 | 1200 | 75 | 70 | 5.6 | 4.4 | 3.05 | 1.5 |
| 820 | 16 × 35 | 130 | 900 | 69 | 65 | 6.2 | 4.9 | 3.4 | 1.7 |
| 1000 | 16 × 39 | 110 | 700 | 57 | 55 | 7.2 | 5.7 | 3.9 | 1.9 |
| 1000 | 18 × 30 | 115 | 700 | 65 | 62 | 5.7 | 4.5 | 3.1 | 1.5 |
| 1200 | 20 × 29 | 85 | 600 | 45 | 44 | 8.0 | 6.3 | 4.35 | 2.2 |
| 1500 | 18 × 39 | 75 | 500 | 45 | 43 | 7.9 | 6.2 | 4.3 | 2.1 |
| 2200 | 21 × 39 | 50 | 450 | 26 | 26 | 11.7 | 9.2 | 6.3 | 6.1 |
| 2700 | 21 × 49 | 40 | 330 | 21 | 21 | 14.7 | 11.5 | 7.9 | 3.9 |
| $V_R = 63 V DC$ | | | | | | | | | |
| 100 | 12 × 30 | 700 | 3300 | 230 | 215 | 3.2 | 2.5 | 1.7 | 0.85 |
| 220 | 14 × 30 | 320 | 1700 | 110 | 102 | 4.6 | 3.6 | 2.5 | 1.25 |
| 330 | 16 × 30 | 220 | 1200 | 80 | 75 | 5.3 | 4.2 | 2.9 | 1.45 |
| 330 | 18 × 25 | 210 | 1200 | 74 | 70 | 5.9 | 4.6 | 3.2 | 1.6 |
| 470 | 16 × 39 | 150 | 900 | 55 | 52 | 7.3 | 5.7 | 4.0 | 2.0 |
| 560 | 20 × 29 | 120 | 630 | 45 | 44 | 8.1 | 6.4 | 4.4 | 2.2 |
| 680 | 18 × 39 | 110 | 550 | 45 | 44 | 7.9 | 6.2 | 4.3 | 2.1 |
| 1000 | 21 × 39 | 70 | 440 | 27 | 27 | 11.8 | 9.2 | 6.4 | 3.2 |
| 1200 | 21 × 49 | 58 | 380 | 22 | 22 | 14.7 | 11.5 | 8.0 | 4.0 |

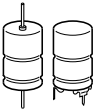

B41693, B41793
High reliability – up to 150 °C

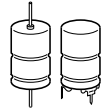
| C_R | Case dimensions | ESR_{max} 100 Hz 20 °C μF | ESR_{max} 100 Hz -40 °C $m\Omega$ | ESR_{max} 10 kHz 20 °C $m\Omega$ | Z_{max} 100 kHz 20 °C $m\Omega$ | $I_{AC,max}$ 10 kHz 105 °C A | $I_{AC,max}$ 10 kHz 125 °C A | $I_{AC,R}$ 10 kHz 125 °C A | $I_{AC,max}$ 10 kHz 150 °C A |
|------------------------------------|-----------------|---|--|---|--|---------------------------------------|---------------------------------------|-------------------------------------|---------------------------------------|
| $V_R = 75$ V DC | | | | | | | | | |
| 100 | 12 × 30 | 600 | 3000 | 200 | 190 | 3.5 | 2.7 | 1.85 | 0.9 |
| 220 | 16 × 30 | 300 | 1500 | 100 | 95 | 5.1 | 4.0 | 2.8 | 1.4 |
| 330 | 16 × 35 | 210 | 1050 | 75 | 72 | 6.3 | 5.0 | 3.4 | 1.7 |
| 470 | 18 × 39 | 140 | 700 | 50 | 48 | 7.9 | 6.2 | 4.3 | 2.1 |
| 470 | 20 × 29 | 135 | 720 | 45 | 44 | 8.2 | 6.4 | 4.4 | 2.2 |
| 680 | 21 × 39 | 95 | 500 | 30 | 30 | 11.5 | 9.0 | 6.2 | 3.1 |
| 1000 | 21 × 49 | 65 | 350 | 22 | 22 | 14.8 | 11.6 | 8.0 | 4.0 |
| $V_R = 100$ V DC | | | | | | | | | |
| 100 | 12 × 30 | 750 | 4000 | 320 | 310 | 2.3 | 1.8 | 1.3 | 0.6 |
| 150 | 14 × 30 | 550 | 2900 | 230 | 225 | 3.0 | 2.4 | 1.7 | 0.8 |
| 220 | 16 × 30 | 350 | 1900 | 160 | 157 | 3.7 | 2.9 | 2.0 | 1.0 |
| 470 | 18 × 39 | 170 | 900 | 75 | 73 | 6.9 | 5.4 | 3.7 | 1.8 |
| 470 | 20 × 29 | 175 | 900 | 78 | 76 | 6.0 | 4.7 | 3.2 | 1.6 |
| 680 | 21 × 39 | 120 | 670 | 58 | 56 | 8.5 | 6.7 | 4.6 | 2.3 |
| 1000 | 21 × 49 | 85 | 500 | 44 | 43 | 11.2 | 8.8 | 6.1 | 3.0 |

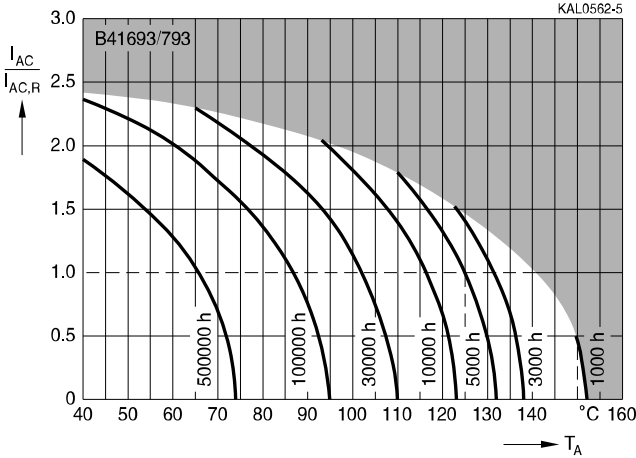

Useful life¹⁾

depending on ambient temperature T_A under ripple current operating conditions at V_R



Useful life¹⁾

depending on case temperature T_C under ripple current operating conditions at V_R

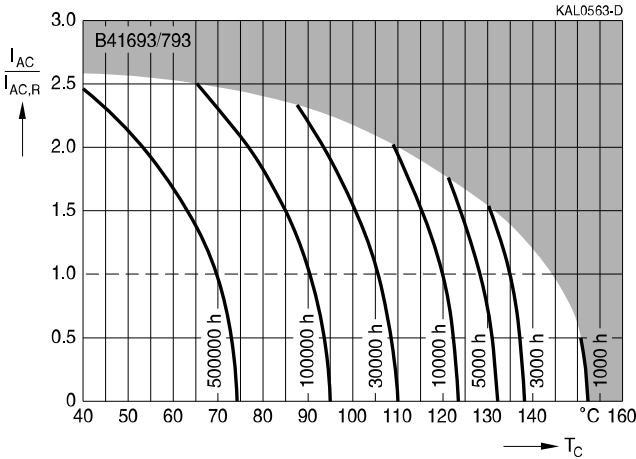

1) Refer to chapter "General technical information, 5 Useful life" on how to interpret useful life.



B41693, B41793

High reliability – up to 150 °C

Frequency factor of permissible ripple current I_{AC} versus frequency f

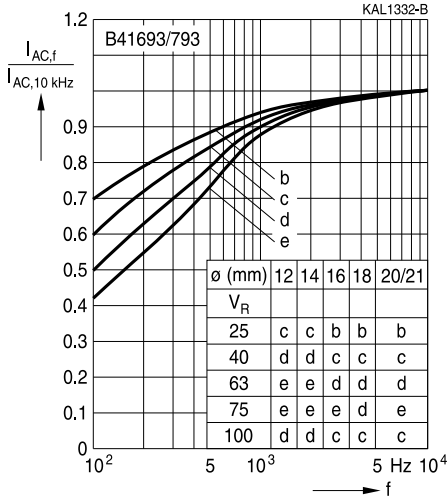

Frequency characteristics of ESR
Typical behavior

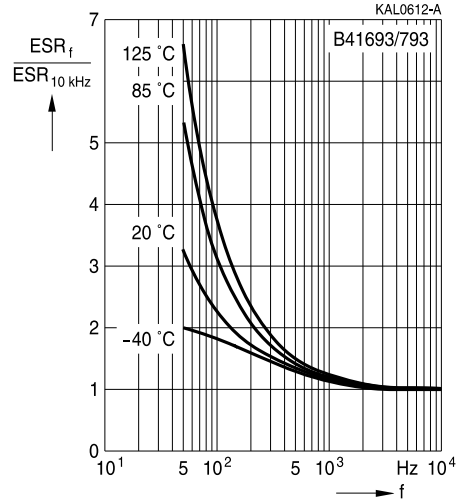

Equivalent series resistance ESR versus frequency f

Typical behavior for 470 μ F/63V

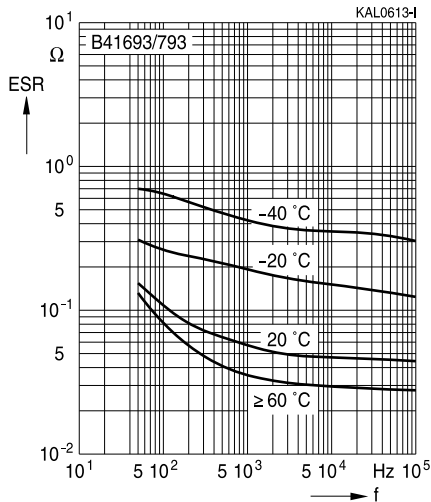

Impedance Z versus frequency f

Typical behavior for 470 μ F/63V

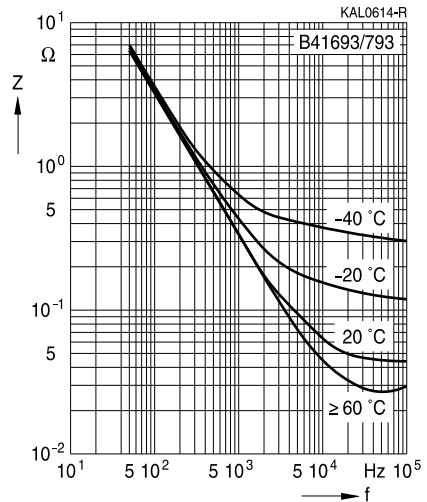

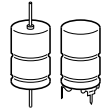

Cautions and warnings

Personal safety

The electrolytes used by EPCOS have been optimized both with a view to the intended application and with regard to health and environmental compatibility. They do not contain any solvents that are detrimental to health, e.g. dimethyl formamide (DMF) or dimethyl acetamide (DMAC).

Furthermore, some of the high-voltage electrolytes used by EPCOS are self-extinguishing.

As far as possible, EPCOS does not use any dangerous chemicals or compounds to produce operating electrolytes. However, in exceptional cases, such materials must be used in order to achieve specific physical and electrical properties because no alternative materials are currently known. However, the amount of dangerous materials used in our products is limited to an absolute minimum.

Materials and chemicals used in EPCOS aluminum electrolytic capacitors are continuously adapted in compliance with the EPCOS Corporate Environmental Policy and the latest EU regulations and guidelines such as RoHS, REACH/SVHC, GADSL, and ELV.

MDS (Material Data Sheets) are available on the EPCOS website for all types listed in the data book. MDS for customer specific capacitors are available upon request.

MSDS (Material Safety Data Sheets) are available for all of our electrolytes upon request.

Nevertheless, the following rules should be observed when handling aluminum electrolytic capacitors: No electrolyte should come into contact with eyes or skin. If electrolyte does come into contact with the skin, wash the affected areas immediately with running water. If the eyes are affected, rinse them for 10 minutes with plenty of water. If symptoms persist, seek medical treatment. Avoid inhaling electrolyte vapor or mists. Workplaces and other affected areas should be well ventilated. Clothing that has been contaminated by electrolyte must be changed and rinsed in water.

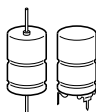

B41693, B41793

High reliability – up to 150 °C

Product safety

The table below summarizes the safety instructions that must be observed without fail. A detailed description can be found in the relevant sections of chapter "General technical information".

| Topic | Safety information | Reference chapter "General technical information" |
|--|---|--|
| Polarity | Make sure that polar capacitors are connected with the right polarity. | 1 "Basic construction of aluminum electrolytic capacitors" |
| Reverse voltage | Voltages polarity classes should be prevented by connecting a diode. | 3.1.6 "Reverse voltage" |
| Mounting position of screw-terminal capacitors | Do not mount the capacitor with the terminals (safety vent) upside down. | 11.1. "Mounting positions of capacitors with screw terminals" |
| Robustness of terminals | The following maximum tightening torques must not be exceeded when connecting screw terminals: M5: 2.5 Nm M6: 4.0 Nm | 11.3 "Mounting torques" |
| Mounting of single-ended capacitors | The internal structure of single-ended capacitors might be damaged if excessive force is applied to the lead wires. Avoid any compressive, tensile or flexural stress. Do not move the capacitor after soldering to PC board. Do not pick up the PC board by the soldered capacitor. Do not insert the capacitor on the PC board with a hole space different to the lead space specified. | 11.4 "Mounting considerations for single-ended capacitors" |
| Soldering | Do not exceed the specified time or temperature limits during soldering. | 11.5 "Soldering" |
| Soldering, cleaning agents | Do not allow halogenated hydrocarbons to come into contact with aluminum electrolytic capacitors. | 11.6 "Cleaning agents" |
| Upper category temperature | Do not exceed the upper category temperature. | 7.2 "Maximum permissible operating temperature" |
| Passive flammability | Avoid external energy, such as fire or electricity. | 8.1 "Passive flammability" |



| Topic | Safety information | Reference chapter "General technical information" |
|--|--|---|
| Active flammability | Avoid overload of the capacitors. | 8.2 "Active flammability" |
| Maintenance | <p>Make periodic inspections of the capacitors.</p> <p>Before the inspection, make sure that the power supply is turned off and carefully discharge the electricity of the capacitors.</p> <p>Do not apply any mechanical stress to the capacitor terminals.</p> | 10 "Maintenance" |
| Storage | Do not store capacitors at high temperatures or high humidity. Capacitors should be stored at +5 to +35 °C and a relative humidity of $\leq 75\%$. | 7.3 Storage conditions |
| | | Reference chapter "Capacitors with screw terminals" |
| Breakdown strength of insulating sleeves | Do not damage the insulating sleeve, especially when ring clips are used for mounting. | "Screw terminals – accessories" |

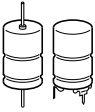

B41693, B41793

High reliability – up to 150 °C

Symbols and terms

| Symbol | English | German |
|----------------|---|---|
| C | Capacitance | Kapazität |
| C_R | Rated capacitance | Nennkapazität |
| C_S | Series capacitance | Serienkapazität |
| $C_{S,T}$ | Series capacitance at temperature T | Serienkapazität bei Temperatur T |
| C_f | Capacitance at frequency f | Kapazität bei Frequenz f |
| d | Case diameter, nominal dimension | Gehäusedurchmesser, Nennmaß |
| d_{max} | Maximum case diameter | Maximaler Gehäusedurchmesser |
| ESL | Self-inductance | Eigeninduktivität |
| ESR | Equivalent series resistance | Ersatzserienwiderstand |
| ESR_f | Equivalent series resistance at frequency f | Ersatzserienwiderstand bei Frequenz f |
| ESR_T | Equivalent series resistance at temperature T | Ersatzserienwiderstand bei Temperatur T |
| f | Frequency | Frequenz |
| I | Current | Strom |
| I_{AC} | Alternating current (ripple current) | Wechselstrom |
| $I_{AC,rms}$ | Root-mean-square value of alternating current | Wechselstrom, Effektivwert |
| $I_{AC,f}$ | Ripple current at frequency f | Wechselstrom bei Frequenz f |
| $I_{AC,max}$ | Maximum permissible ripple current | Maximal zulässiger Wechselstrom |
| $I_{AC,R}$ | Rated ripple current | Nennwechselstrom |
| $I_{AC,R} (B)$ | Rated ripple current for base cooling | Nennwechselstromstrom für Bodenkühlung |
| I_{leak} | Leakage current | Reststrom |
| $I_{leak,op}$ | Operating leakage current | Betriebsreststrom |
| l | Case length, nominal dimension | Gehäuselänge, Nennmaß |
| l_{max} | Maximum case length (without terminals and mounting stud) | Maximale Gehäuselänge (ohne Anschlüsse und Gewindebolzen) |
| R | Resistance | Widerstand |
| R_{ins} | Insulation resistance | Isolationswiderstand |
| R_{symm} | Balancing resistance | Symmetrierwiderstand |
| T | Temperature | Temperatur |
| ΔT | Temperature difference | Temperaturdifferenz |
| T_A | Ambient temperature | Umgebungstemperatur |
| T_C | Case temperature | Gehäusetemperatur |
| T_B | Capacitor base temperature | Temperatur des Becherbodens |
| t | Time | Zeit |
| Δt | Period | Zeitraum |
| t_b | Service life (operating hours) | Brauchbarkeitsdauer (Betriebszeit) |

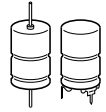

| Symbol | English | German |
|-----------------|-----------------------------|-----------------------------------|
| V | Voltage | Spannung |
| V _F | Forming voltage | Formierspannung |
| V _{op} | Operating voltage | Betriebsspannung |
| V _R | Rated voltage, DC voltage | Nennspannung, Gleichspannung |
| V _S | Surge voltage | Spitzenspannung |
| X _C | Capacitive reactance | Kapazitiver Blindwiderstand |
| X _L | Inductive reactance | Induktiver Blindwiderstand |
| Z | Impedance | Scheinwiderstand |
| Z _T | Impedance at temperature T | Scheinwiderstand bei Temperatur T |
| tan δ | Dissipation factor | Verlustfaktor |
| λ | Failure rate | Ausfallrate |
| ε ₀ | Absolute permittivity | Elektrische Feldkonstante |
| ε _r | Relative permittivity | Dielektrizitätszahl |
| ω | Angular velocity; 2 · π · f | Kreisfrequenz; 2 · π · f |

Note

All dimensions are given in mm.

Important notes

The following applies to all products named in this publication:

1. Some parts of this publication contain **statements about the suitability of our products for certain areas of application**. These statements are based on our knowledge of typical requirements that are often placed on our products in the areas of application concerned. We nevertheless expressly point out **that such statements cannot be regarded as binding statements about the suitability of our products for a particular customer application**. As a rule, EPCOS is either unfamiliar with individual customer applications or less familiar with them than the customers themselves. For these reasons, it is always ultimately incumbent on the customer to check and decide whether an EPCOS product with the properties described in the product specification is suitable for use in a particular customer application.
2. We also point out that **in individual cases, a malfunction of electronic components or failure before the end of their usual service life cannot be completely ruled out in the current state of the art, even if they are operated as specified**. In customer applications requiring a very high level of operational safety and especially in customer applications in which the malfunction or failure of an electronic component could endanger human life or health (e.g. in accident prevention or lifesaving systems), it must therefore be ensured by means of suitable design of the customer application or other action taken by the customer (e.g. installation of protective circuitry or redundancy) that no injury or damage is sustained by third parties in the event of malfunction or failure of an electronic component.
3. **The warnings, cautions and product-specific notes must be observed.**
4. In order to satisfy certain technical requirements, **some of the products described in this publication may contain substances subject to restrictions in certain jurisdictions (e.g. because they are classed as hazardous)**. Useful information on this will be found in our Material Data Sheets on the Internet (www.epcos.com/material). Should you have any more detailed questions, please contact our sales offices.
5. We constantly strive to improve our products. Consequently, **the products described in this publication may change from time to time**. The same is true of the corresponding product specifications. Please check therefore to what extent product descriptions and specifications contained in this publication are still applicable before or when you place an order. We also **reserve the right to discontinue production and delivery of products**. Consequently, we cannot guarantee that all products named in this publication will always be available. The aforementioned does not apply in the case of individual agreements deviating from the foregoing for customer-specific products.
6. Unless otherwise agreed in individual contracts, **all orders are subject to the current version of the "General Terms of Delivery for Products and Services in the Electrical Industry" published by the German Electrical and Electronics Industry Association (ZVEI)**.
7. The trade names EPCOS, BAOKE, Alu-X, CeraDiode, CeraLink, CSMP, CSSP, CTVS, DeltaCap, DigiSiMic, DSSP, FilterCap, FormFit, MiniBlue, MiniCell, MKD, MKK, MLSC, MotorCap, PCC, PhaseCap, PhaseCube, PhaseMod, PhiCap, SIFERRIT, SIFI, SIKOREL, SilverCap, SIMDAD, SiMic, SIMID, SineFormer, SIOV, SIP5D, SIP5K, ThermoFuse, WindCap are **trademarks registered or pending** in Europe and in other countries. Further information will be found on the Internet at www.epcos.com/trademarks.