

# THM LOW PROFILE LITHIUM & ALKALINE CELL HOLDERS

"1/2AA" • "CR2" • "AA" • "2/3A"

## FEATURES

- Snap-In PC contact holds firmly in position for wave soldering
- Tin Nickel Plated contacts for excellent solderability and durability
- Polarity clearly marked for orientation
- Snap-on retainer cover (optional) retains battery securely to withstand shock and vibration. Helps protect against shorting. Tamper-proof.

## APPLICATIONS

- Computer memory, power backup systems.
- Telecommunications
- Residential, industrial and commercial security systems
- PLC and industrial controls



### THM LOW PROFILE

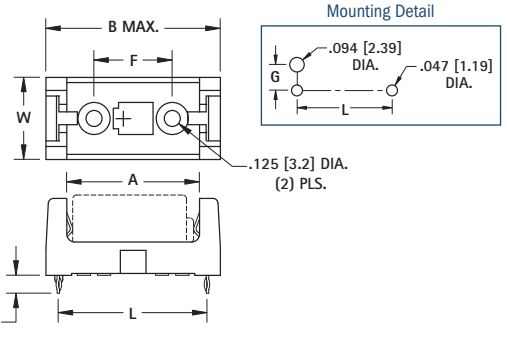

## SPECIFICATIONS

**Base/Retainer Cover:** PBT, UL 94V-0  
**Contacts:** .012 (.30) Stainless Steel, Tin-Nickel Plate  
**Operating Temp Range:** -60°F to +290°F (-50°C to +145°C)

HOLDER CAT. NO.	COVER CAT. NO.	L	W	H (Ref. Dim)	A	B (MAX)	F	G	CELL SIZE	BATTERY CROSS REFERENCE
108	108C	1.160 (29.5)	.640 (16.3)	.633 (16.1)	1.030 (26.2)	1.360 (34.5)	.610 (15.5)	.279 (7.1)	"1/2 AA" "CR2"	Energizer 544, CR2, Duracell PX28L, CR2, Kodak K28A & KS28, CR2, Panasonic CR14250, CR2, Saft LCP3, Maxell 4LR44, CR2, Sanyo CR14250SE, CR2
1028	1024C 1028C	2.160 (54.9)	.640 (16.3)	.633 (16.1)	2.040 (51.8)	2.360 (59.9)	1.610 (40.9)	.279 (7.1)	"AA"	Energizer, Duracell, Panasonic, Sanyo, Varta, Rayovac, Tadiran
1029	1029C 1029LC	1.500 (38.1)	.720 (18.3)	.712 (18.1)	1.375 (34.9)	1.700 (43.2)	.950 (24.1)	.320 (8.1)	"2/3 A"	Duracell DL2/3A, Kodak K123L, Panasonic CR123A, Saft 450SC & VR0450, Sanyo CR17335SE

### THM ULTRA LOW PROFILE



## SPECIFICATIONS

**Base:** High Temp Nylon 46, - UL 94V-0  
**Contacts:** .012 (.30) Phosphor Bronze, Tin-Nickel Plate  
**Operating Temp Range:** -60°F to +290°F (-50°C to +145°C)

### SINGLE

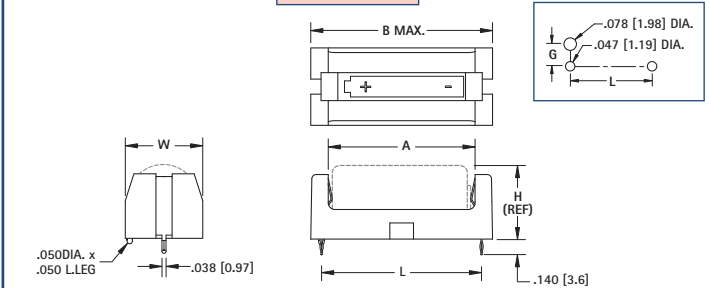

DWG. 1

Finish: Tin-Nickel Plate

### DUAL

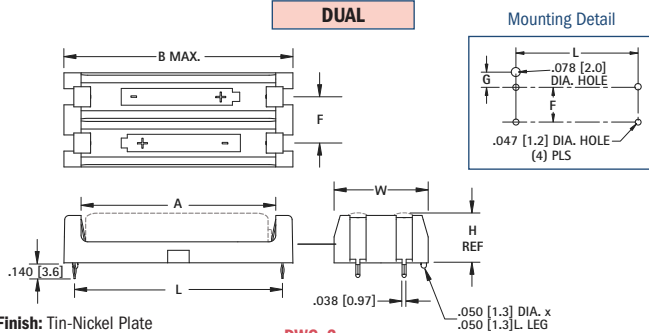

DWG. 2

Finish: Tin-Nickel Plate

### "1/3N"

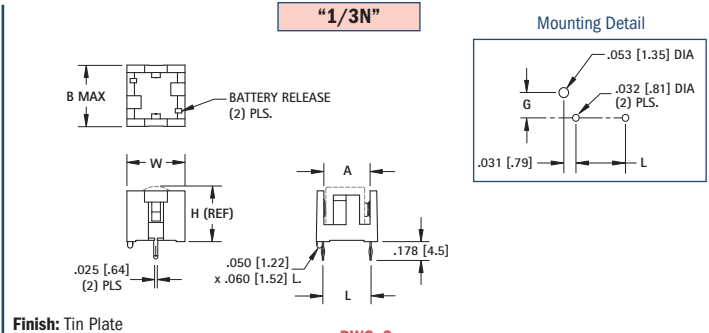

DWG. 3

Finish: Tin Plate

HOLDER CAT. NO.	COVER CAT. NO.	DWG NO.	L	W	H (Ref. Dim)	A	B (MAX)	F	G	CELL SIZE	BATTERY CROSS REFERENCE
1015	1024C	1	2.145 (54.5)	.612 (15.5)	.603 (15.3)	2.040 (51.8)	2.359 (59.9)	-	.265 (6.7)	"AA"	Energizer, Duracell, Panasonic, Sanyo, Varta, Rayovac, Tadiran
1013	1012C	2	2.145 (54.5)	1.180 (30.0)	.603 (15.3)	2.040 (51.8)	2.359 (59.9)	.568 (14.4)	.265 (6.7)	"AA"	Energizer, Duracell, Panasonic, Sanyo, Varta, Rayovac, Tadiran
1021	1020C	1	1.933 (49.1)	.500 (12.7)	.445 (11.3)	1.810 (46.0)	2.140 (54.4)	-	.209 (5.3)	"AAA"	Energizer, Duracell, Panasonic, Sanyo, Varta, Rayovac, Tadiran
1023	1022C	2	1.933 (49.1)	.875 (22.2)	.445 (11.3)	1.810 (46.0)	2.140 (54.4)	.430 (10.9)	.182 (4.6)	"AAA"	Energizer, Duracell, Panasonic, Sanyo, Varta, Rayovac, Tadiran
1019	1018C	1	1.487 (37.8)	.720 (18.3)	.682 (17.3)	1.365 (42.9)	1.690 (42.9)	-	.319 (8.1)	"2/3 A"	Duracell DL2/3A, Kodak K123L, Panasonic CR123A, Saft 450SC & VR0450, Sanyo CR17335SE
1017	1024C	1	1.156 (29.4)	.612 (15.5)	.603 (15.3)	1.030 (26.2)	1.360 (34.5)	-	.265 (6.7)	"1/2 AA"	Energizer 544, Duracell PX28L, Kodak K28A & KS28, Saft LCP3, Maxell 4LR44, Sanyo CR14250SE
503	-	3	.450 (11.4)	.540 (13.7)	.506 (12.9)	.430 (10.9)	.570 (14.5)	-	.240 (6.1)	"1/3 N"	Duracell DL1/3N, Sanyo K58L, Energizer CR1/3N

THM BATTERY HOLDERS

# SMT LOW PROFILE LITHIUM & ALKALINE CELL HOLDERS

"1/2AA" · "AA" · "2/3A"

AVAILABLE ON TAPE AND REEL

## FEATURES

- Low profile surface mount holders for Cylindrical Lithium and Alkaline batteries
- UL 94V-0 Heat resistant Nylon Housings well suited for reflow soldering
- Designed for vacuum pick and place assembly
- Gold-plated Phosphor Bronze contacts assure low contact resistance and are readily solderable

- Ideal for both lead free solder and traditional solder process
- Battery installation and removal does not require tools
- Securely holds battery in place
- Polarity clearly marked for orientation
- **Operating Temp Range:**  
-60°F to +290°F (-50°C to +145°C)

## APPLICATIONS

- Computer memory, power backup systems
- Telecommunications
- Residential, industrial and commercial security systems
- PLC and industrial controls

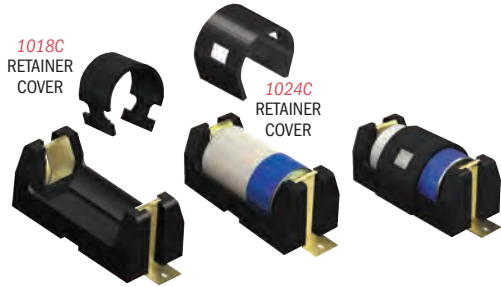

## SMT ULTRA LOW PROFILE

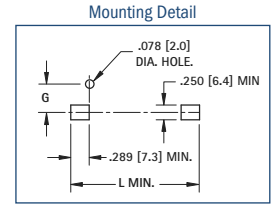
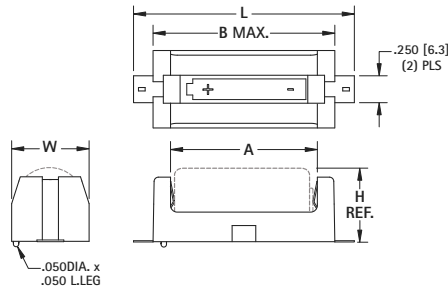

## SPECIFICATIONS

**Base:** High Temp Nylon 46, UL 94V-0

**Contacts:** .012 (.30) Phosphor Bronze, Gold Plate (Flash)

CAT. NO.	ON TAPE BULK	ON TAPE & REEL	COVER	L	W	H (REF)	A	B (MAX)	G	CELL SIZE	TAPE & REEL SPECS PACKED ON 13" REEL	BATTERY CROSS REFERENCE
1016	1016TR	1024C	1024C	1.723 (43.8)	.612 (15.5)	.603 (15.3)	1.030 (26.2)	1.360 (34.5)	.265 (6.7)	"1/2 AA"	56mm wide, 24mm pitch 125 pcs/reel	Energizer 544, Duracell PX28L, Kodak K28A & KS28, Panasonic CR14250, Saft LCP3, Maxell 4LR44, Sanyo CR14250SE
1024	1024TR	1024C	1024C	2.711 (68.9)	.612 (15.5)	.603 (15.3)	2.040 (51.8)	2.359 (59.9)	.265 (6.7)	"AA"	88mm wide, 28mm pitch, 100 pcs/reel	Energizer, Duracell, Panasonic, Sanyo, Varta, Rayovac, Tadiran
1018	1018TR	1018C	1018C	2.053 (52.2)	.720 (18.3)	.682 (17.3)	1.365 (34.7)	1.690 (42.9)	.319 (8.1)	"2/3 A"	72mm wide, 32mm pitch, 100 pcs/reel	Duracell DL2/3A, Kodak K123L, Panasonic CR123A, Saft 450SC & VR0450, Sanyo CR17335SE

## SMT ULTRA LOW PROFILE



## SPECIFICATIONS

**Base:** High Temp Nylon 46, UL 94V-0

**Contacts:** .012 (.30) Phosphor Bronze, Gold Plate (Flash)

**Operating Temp:** -60°F to +290°F (-50°C to +145°C)

## SINGLE

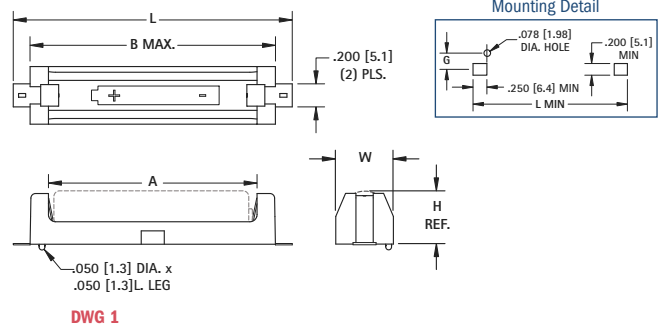

DWG 1

## DUAL

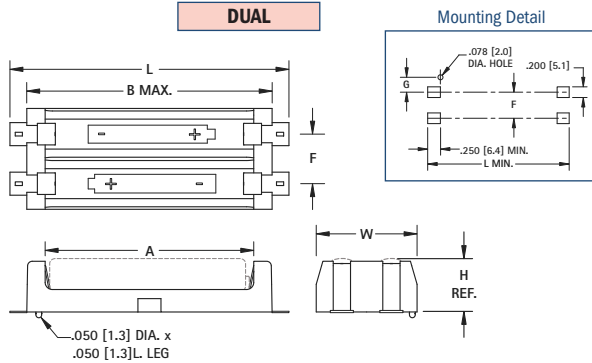

DWG 2

## "1/3N"

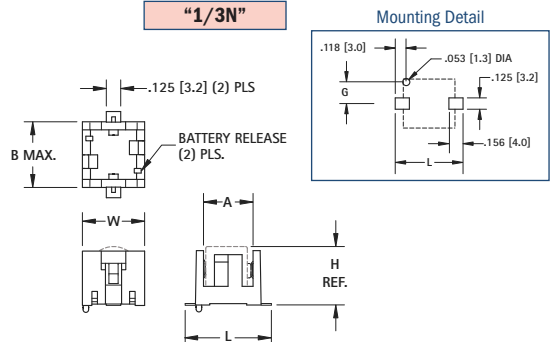

DWG 3

CAT. NO.	ON TAPE BULK	ON TAPE & REEL	COVER	DWG NO.	L	W	H (REF)	A	B (MAX)	F	G	CELL SIZE	TAPE AND REEL SPECS PACKED ON 13" REEL	BATTERY CROSS REFERENCE
1020	1020TR	1020C	1020C	1	2.421 (61.5)	.500 (12.7)	.445 (11.3)	1.810 (46.0)	2.140 (54.4)	-	.209 (5.3)	"AAA"	88mm Wide, 24mm pitch, 200 pcs/reel	Energizer, Duracell, Panasonic, Sanyo, Varta, Rayovac, Tadiran
1022	1022TR	1022C	1022C	2	2.421 (61.5)	.875 (22.2)	.445 (11.3)	1.810 (46.0)	2.140 (54.4)	.430 (10.9)	.182 (4.6)	"AAA"	88mm Wide, 32mm pitch, 125 pcs/reel	Energizer, Duracell, Panasonic, Sanyo, Varta, Rayovac, Tadiran
1012	1012TR	1012C	1012C	2	2.711 (68.9)	1.180 (30.0)	.603 (15.3)	2.040 (51.8)	2.359 (59.9)	.568 (14.4)	.265 (6.7)	"AA"	88mm Wide, 48mm pitch, 100 pcs/reel	Energizer, Duracell, Panasonic, Sanyo, Varta, Rayovac, Tadiran
498	498TR	-	-	3	.748 (19.0)	.540 (13.7)	.506 (12.9)	.430 (10.9)	.570 (14.5)	-	.240 (6.1)	"1/3 N"	44mm Wide, 24mm pitch, 125 pcs/reel	Duracell DL1/3N, Sanyo K58L, Energizer CR1/3N

# SMT & THM POLARIZED LITHIUM CELL HOLDERS

“CR2” - “CR123A”

### FEATURES

- Low profile surface mount and Thru Hole Mount Holders for Lithium batteries
- UL 94V-0 Heat resistant Nylon Housings well suited for reflow or wave soldering.

- Battery installation and removal does not require tools.
- Securely holds battery in place
- Polarized holder offers circuit protection against improper battery installation

### APPLICATIONS

- Computer memory, power backup systems
- Telecommunications
- Residential, industrial security systems
- PLC and industrial controls

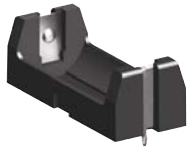

Thru-Hole Mount (THM)

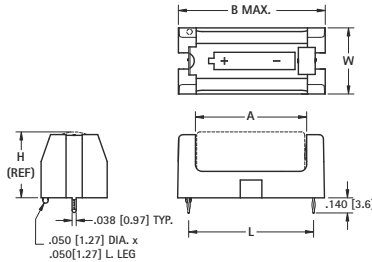

1018C  
RETAINER  
COVER  
FITS ALL  
HOLDERS

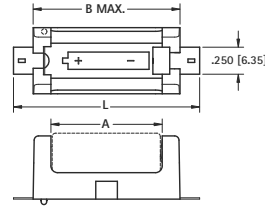

Surface Mount (SMT)

Mounting Detail

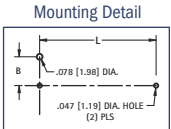
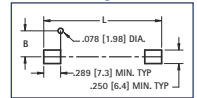

### SPECIFICATIONS

**Base:** High Temp Nylon 46, UL Rated 94V-0  
**Contacts:** .012 (1.30) Phosphor Bronze, Gold Plate (Flash) - SMT  
 .012 (1.30) Phosphor Bronze, Tin-Nickel Plate - THM  
**Operating temp range:** -60°F to 290°F (-50°C to 145°C)

CAT. NO.	MOUNTING STYLE	L	W	H (Ref)	A	B (MAX)	G	CELL SIZE
1010	SMT	1.723 (43.8)						
1011	THM	1.156 (29.4)	.612 (15.5)	.661 (16.8)	1.030 (26.2)	1.360 (34.5)	.265 (6.7)	CR2
1050	SMT	2.062 (52.4)						
1051	THM	1.487 (37.8)	.720 (18.3)	.712 (18.1)	1.365 (34.7)	1.690 (42.9)	.319 (8.1)	CR123A

## RUGGED STEEL & ALUMINUM LITHIUM CELL HOLDERS

- Sturdily constructed of quality materials
- Contacts made from Brass, Nickel Plate
- Ideal for punishing applications

### STEEL HOLDERS “1/2AA”



CAT. NO. 2103

CAT. NO. 1103

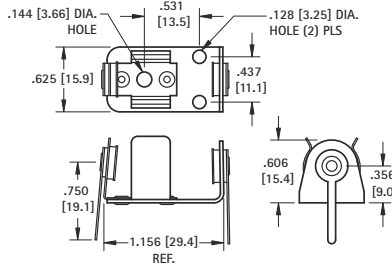

### BATTERY CROSS REFERENCE

**Eveready:** 544, **Duracell:** PX28L, **Kodak:** K28A & KS28, **Panasonic:** CR14250, **Sanyo:** CR14250SE, **Saft:** LCP3, **Maxell:** 4LR44

Mounting Detail

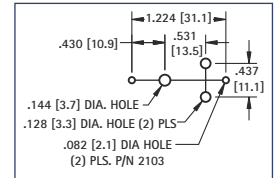

### ALUMINUM HOLDERS “2/3A”



CAT. NO. 131

CAT. NO. 132

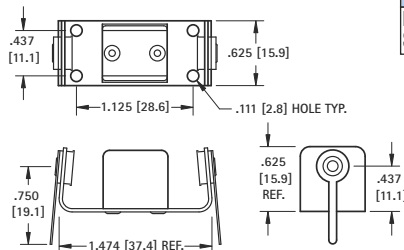

### BATTERY CROSS REFERENCE

**Duracell:** DL2/3A, **Kodak:** K123L, **Sanyo:** CR173335SE, **Saft:** 450SC & VR0450

Mounting Detail

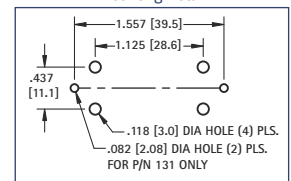

## 6 VOLT LITHIUM CELL HOLDERS

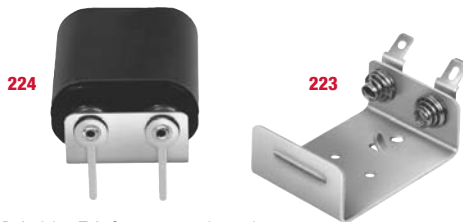

- Polarizing Tab for proper orientation
- Lightweight, ideal for rugged applications
- DL223A or Equivalent Batteries

### SPECIFICATIONS

**Frame:** Aluminum 2024-T3 **Terminals:** Brass, Tin Plate  
**Spring Contacts:** .025 (.64) Dia. Spring Steel, Nickel Plate

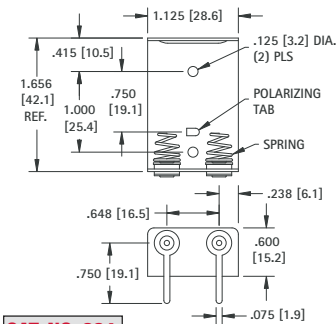

CAT. NO. 224

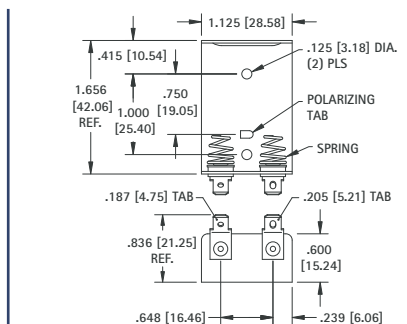

CAT. NO. 223