

INDUSTRIAL AND POWER PROTECTION

CATALOGUE



THE **GLOBAL SPECIALIST**
IN ELECTRICAL AND DIGITAL BUILDING INFRASTRUCTURES

Enclosures and equipment



P. 12
Atlantic-E
wall mounting
steel enclosures
IP 66 - IK 10

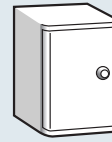

P. 16
Atlantic
wall mounting
304 L and 316 L
stainless enclosures
IP 66 - IK 10

Transcab® open slot panel trunking



P. 48
Introduction
to Transcab

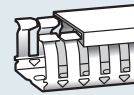

P. 50
Transcab
PVC panel
trunking

Power distribution and protection

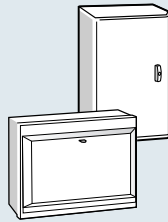

P. 56
Type B and
type A
distribution
boards

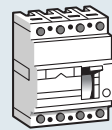

P. 62
DPX
MCCBs

Isolation, control and signalling

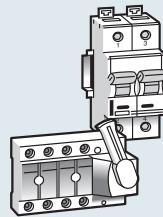

P. 100
Isolating and
changeover
switches

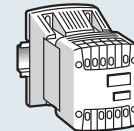

P. 106
Control and
compact
transformers

Viking 3 terminal blocks



P. 132
Selection chart

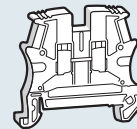

P. 132
Terminal blocks –
screw
connection

Cable marking systems and cable accessories

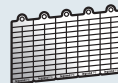

P. 154
Marking label
sheets



P. 154
CAB 3
marking system

Industrial plugs, sockets and combination units



P. 168
Hypra Prisinter
sockets
IP 44/55

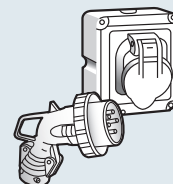

P. 174
Hypra
plugs and sockets
IP 44 and
IP 66/67-55

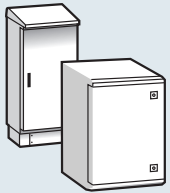

P. 18
Marina
wall mounting
and free standing
GRP enclosures
IP 66 - IK 10

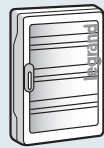

P. 33
Plexo³
weatherproof
enclosures
and terminal
shield boxes

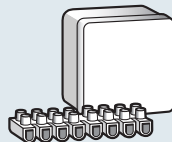

P. 36
Plexo
weatherproof
boxes and
Nylbloc
terminal strips

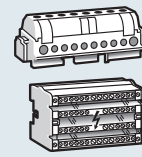

P. 42
Distribution
terminal blocks

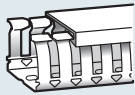

P. 50
Transcab
PC/ABS halogen
free panel
trunking



P. 50
Transcab
cutting tool



P. 50
Cable retainer,
marking and fixing
accessories and
braided sleeving



P. 51
Technical
information

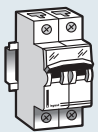

P. 79
DX-H and DX-D
MCBs

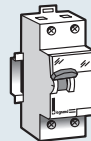

P. 83
DX
RCDs

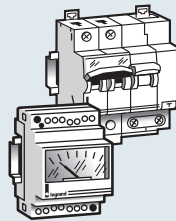

P. 84
DX
RCBOs and
metering

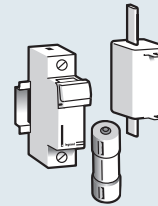

P. 89
Fuse carriers
and fuses

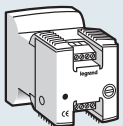

P. 112
Filtered power
supplies



P. 114
Power
contactors

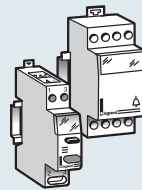

P. 116
Push buttons/
control switches,
indicators,
transformers
and buzzers



P. 120
Time switches,
light sensitive and
time-lag switches

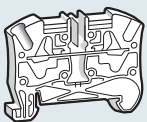

P. 136
Terminal blocks -
spring
connection

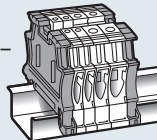

P. 140
Accessories for
terminal blocks

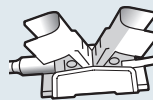

P. 147
Heavy duty
terminal blocks
for copper and
aluminium cables

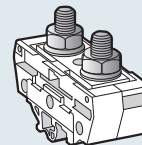

P. 148
Heavy duty
terminal blocks
for copper bars
and cable lugs



P. 156
CAB 3
marking system
accessories

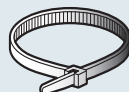

P. 157
Colring
cable ties



P. 157
Colson
cable ties

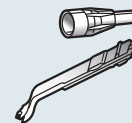

P. 160
Starfix
ferrules and
crimping tools

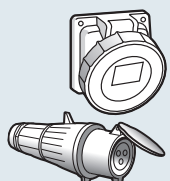

P. 188
P 17 Tempra
plugs and sockets
IP 44 and
IP 66/67



P. 196
Hypra
combination units
IP 44 and
IP 66/67-55



P. 200
P 17 Tempra
combination units
IP 44, IP 55 and
IP 66

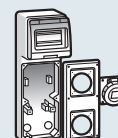

P. 201
P 17 Tempra
self assembly
combination units
IP 44

An industrial portfolio full of innovation

With high quality products throughout its industrial portfolio, Legrand is in an unbeatable position... offering integrated solutions designed to meet your needs whatever the budget or installation requirements.

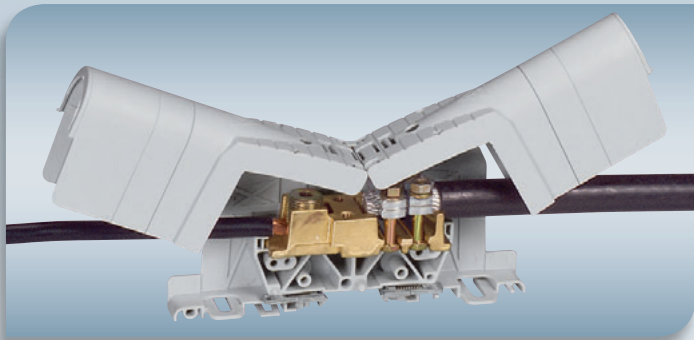

Heavy duty terminal blocks... a simple, trusted solution for the termination of large cables and long cable runs. Multiple termination and mounting options enhance flexibility, (see p. 146 to 149)

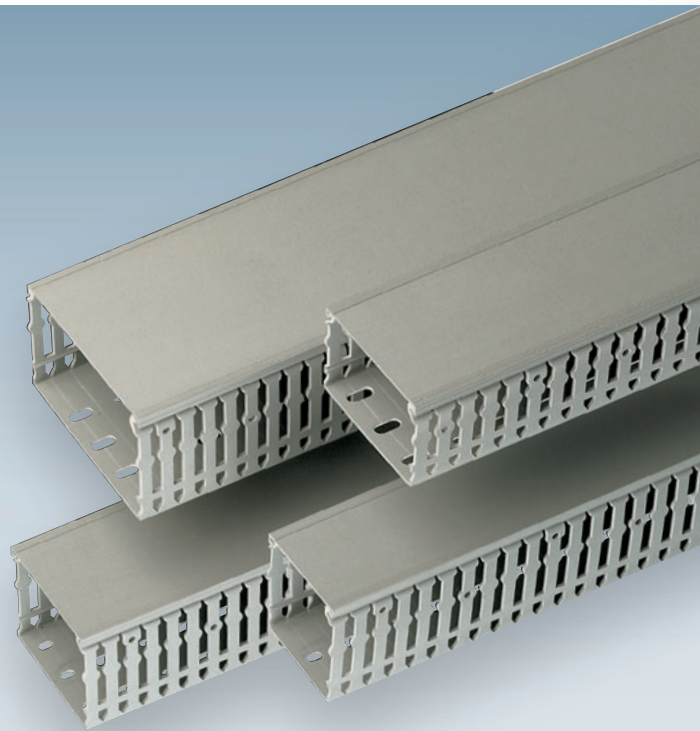

Uniquely different, Transcab open slot panel trunking features a snap to length base and removable fingers, support ribs for strength and rigidity and a clip-on lid for rapid installation... panel cabling couldn't be easier! (see p. 166 to 171)



Atlantic-E mild steel enclosures are the latest addition to Legrand's enclosure range. Available in 27 sizes, and supplied complete with removable plain plate, earth connection braid and wall mounting brackets, (see p. 12 to 15)



With a 0.1 second clock precision, zero crossing switching and expanded offset programming, the new range of programmable AlphaRex³ time switches offers unbeatable accuracy, (see p. 118 to 121)

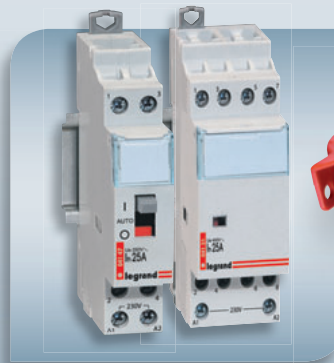

Legrand's popular DIN rail mounted power contactors are available in 2P, 3P and 4P versions with normally open and normally closed contact options, (see p. 114 to 115)



When safety, reliability and robustness are key, Hypra Prisinter sockets are the perfect choice. With a unique load break and interlock switch, Hypra provides the highest level of safety within a compact design. (see p. 166 to 171)

Legrand - global strength built on local knowledge



Legrand is the global specialist in electrical and digital building infrastructures. Innovation is the driving force behind its development. With an increasing investment in research and development (circa 5% of sales) and more than 4,000 active patents, the Legrand Group is focused on maintaining a high rate of new product launches that present innovative solutions to the market.



Sustainable development



From design through to manufacturing, the Legrand Group selects materials and processes that respect people and the environment.

- Efficient and environmentally aware product design
- Product functions that help to avoid energy waste
- Management of manufacturing and logistics sites
- Integration of environmental concerns and ISO 14001 procedures at the Group's global sites.*

* 84% of sites are ISO 14001:2004 accredited including all UK sites.



Legrand in the UK - powered by specialists

In the UK Legrand has developed a customer focused structure which harnesses the power of its market leading specialist brands including Bticino, Electrak and Zucchini to deliver innovative, integrated solutions for every phase of construction.

alphabetical list

A

AlphaRex ³ time switches	118 to 122
Ammeters	85
Atlantic-E steel enclosures	
Cabstop plates	14
crosspieces	26
equipment and fixing accessories	26
features information	12 to 13
insulated modular chassis	25
internal doors	25
locking accessories	14
plinths	14
roofs	14
sectioned uprights	26
selection chart	10 to 11
steel enclosures	14
technical information	15
wall mounting brackets	14
Atlantic stainless steel enclosures	
crosspieces	26
equipment and fixing accessories	26
features information	8
insulated modular chassis	25
internal doors	25
locking accessories	28
sectioned uprights	26
selection chart	10 to 11
stainless steel enclosures – 304 L	16
stainless steel enclosures – 316 L	16
technical information	16 to 17
wall mounting brackets	16

B

Bell transformers	116
Blade type cartridge fuses (HRC)	93 to 94
Boxes	
Plexo weatherproof boxes	36 to 41
Terminal shield boxes	35
Buzzers	116 to 117

C

CAB 3 cable markers	154 to 156
Cable trunking (Transcab)	48 to 51
Cable marking systems (CAB 3)	154 to 156
Cable ties	
Colring	157
Colson	157
Cartridge fuses and accessories	91 to 95
Changeover switches	103
Colring	
cable ties and tool	157
technical information	158
Colson	
cable ties and tool	157
technical information	159
Combination units	
Hypra	196 to 199
P17 Tempra	200 to 203
Compact transformers	
accessories	108
single phase	108
technical information	109, 110 to 111
Contactors	114
Control and signalling auxiliaries	
power contactors	114
MCCBs	68
RCDs	83
Control switches	116
Control transformers	
single phase	106
technical information	107, 110 to 111
Cylindrical cartridge fuses (HRC)	91 to 95

D

Distribution blocks	
self assembly distribution blocks	45
distribution terminal blocks	42
extra-flat distribution blocks	44
modular style distribution blocks	43
stepped distribution blocks	44
Distribution boards	
Type A	61
Type B	56 to 60

Distribution terminal blocks	
fully shrouded	42
partly shrouded	42
supports for terminal blocks	42
technical information	42
unshrouded	42
DPX MCCBs	
association and co-ordination information	76
control and signalling auxiliaries	68
dimensions	77 to 78
DPX 125	64
DPX 250 ER	65
DPX 250	66
DPX 630	67
DPX 1250	68
key to characteristic curves	69
selection chart	62 to 63
selectivity table	75
technical information	69 to 78
DX MCBs (DX-H and DX-D)	
dimensions	88
discrimination/selectivity tables	82
DX-H MCBs – 10 kA	79
DX-D MCBs – 10 kA	79
technical information	80
tripping and operating curves	81
DX RCBOs	84
DX RCDs	83

E

EconoRex analogue time switches	126
Electronic time-lag switch	127
Enclosures	
Atlantic-E steel	14
Atlantic stainless steel	16
crosspieces	26
equipment and fixing accessories	26
features information	8 to 9
insulated modular chassis	25
internal doors	25
locking accessories	14, 28
Marina GRP	18 to 22
Plexo ³ weatherproof IP 65	33 to 34
Plexo weatherproof boxes	36 to 41
sectioned uprights	21, 26
selection chart	10 to 11
ventilation	29
universal plates	23

F

Ferrules (Starfix)	160
Filtered power supplies	
electrical characteristics	113
single phase	112
technical information	112
Free standing enclosures (Marina)	21
Fuses	
blade type cartridge fuse accessories	94
cylindrical cartridge fuses HRC	91 to 92
HRC blade type cartridge fuses	93 to 94
modular carriers for HRC aM and gG fuses	89
SP fuse carriers	89
technical information	95

G

GRP (Marina) enclosures	
equipment and fixing accessories	26
features information	8
free standing	21
locking accessories	28
selection chart	10 to 11
wall mounting	18

H

HRC blade type cartridge fuses	93 to 95
Hypra combination units	
IP 44 - LV 16/32/63 A units	196
IP 66/67-55 - LV 16/32/63/125 A units	197
technical information	198 to 199
Hypra IP 44 plugs and sockets	
back boxes	175, 176
ELV 16 A and LV 16 A	175
LV 32 A	176

LV 63 A	176
mobile sockets	175, 176
panel appliance inlets	175, 176
panel mounting sockets	175, 176
selection chart	174
straight plugs	175, 176
surface mounting sockets	175, 176
technical information	177 to 179
Hypra IP 44/55 Prisinter sockets	
interlocked switched sockets LV 16 A	168
interlocked switched sockets LV 32 A	169
interlocked switched sockets LV 63 A	169
selection chart	168
technical information	170 to 171
Hypra IP 66/67-55 plugs and sockets	
angled plugs	181, 182
back boxes	181, 182
LV 16 A	181
LV 32 A	182
LV 63 A	182
LV 125 A	182
mobile sockets	181, 182
panel mounting sockets	181, 182
selection chart	180
straight plugs	181, 182
surface mounting sockets	181, 182
technical information	183 to 185

I

Indicators	116
Industrial plugs and sockets	
Hypra appliance inlets	174
Hypra IP 44 plugs and sockets	174 to 179
Hypra IP 44/55 Prisinter sockets	168 to 169
Hypra IP 66/67-55 plugs and sockets	180 to 185
P17 Tempra appliance inlets	189
P17 Tempra IP 44 plugs and sockets	188 to 191
P17 Tempra IP 66/67	
plugs and sockets	188, 192 to 193
Industrial plugs and sockets conformity	
to international standards	204
Insulated modular chassis for enclosures	25
Internal doors for wall mounting enclosures	25
IP table	205
Isolation and protection changeover switches	103
Isolating switches	
16 to 125 A	100
Vistop 63 to 160 A	101 to 102

L

Light control switches	
Microlux D	127
Locking accessories for enclosures	14, 28

M

Marina GRP enclosures	
equipment and fixing accessories	26
features information	8
free standing	21
free standing technical information	22
insulated modular chassis	25
internal doors	25
lifting accessories	21
locking accessories	28
plinths	21
roofs	21
sectioned uprights	21
selection chart	10 to 11
wall mounting	18
wall mounting technical information	19 to 20
Marking label sheets	154
Marking systems	
CAB 3	154 to 156
for cables	154
for Viking terminal blocks	154
MaxiRex time switches	
analogue surface and panel mounting	126
digital surface and panel mounting	124
MCCBs	
dimensions	88
discrimination/selectivity tables	82
DX-H MCBs – 10 kA	79
DX-D MCBs – 10 kA	79
technical information	80
tripping and operating curves	81

MCCBs	
association and co-ordination information	76
control and signalling auxiliaries	68
dimensions	77 to 78
DPX 125	64
DPX 250 ER	65
DPX 250	66
DPX 630	67
DPX 1250	68
key to characteristic curves	69
selection chart	62 to 63
selectivity table	75
technical information	69 to 78
Metering	85 to 88
MicroRex time switches	
Microlux D light sensitive switch	127
MicroRex analogue for rail	125
MicroRex D digital for rail	123
Mobile P17 Tempra combination units	200 to 203
Modular device accessories	90
Modular DIN rail equipment	
bell transformers	116
buzzers	116
changeover switches	103
discrimination/selectivity tables	82
DPX MCCBs	64 to 68
DX MCCBs	79
DX RCBOs	84
DX RCDs	83
indicators	116
isolating switches	100
modular DIN rail equipment dimensions	117
power contactors	114
push buttons/control switches	116
safety transformers	116
Modular fuse carriers	
accessories	90
for HRC type aM and gG fuses	89
SP fuse carriers	89
technical information	89

N

Nylbloc terminal strips	41
-------------------------	----

O

Open panel trunking (Transcab)	50
--------------------------------	----

P

P17 Tempra combination units	
self assembly	201
surface mounting	200
technical information	202 to 203
P17 Tempra IP 44 plugs and sockets	
appliance inlets	189
LV 16 A	189
LV 32 A	189
mobile sockets	189
panel mounting sockets	189
selection chart	188
straight plugs	189
surface mounting sockets	189
technical information	190 to 191
P17 Tempra IP 66/67 plugs and sockets	
LV 16 A	192
LV 32 A	192
LV 63 A	192
mobile sockets	192
selection chart	188
straight plugs	192
surface mounting sockets	192
technical information	192 to 193
Panel trunking (Transcab)	50
Panel mounting sockets	
Hypra	172 to 185
Hypra Prisinter	166 to 171
P17 Tempra	186 to 191
Plexo ³ weatherproof enclosures IP 65	
accessories	33
enclosures 2 to 8 modules per row	33
enclosures 12 modules per row	33
enclosures 18 modules per row	33
features information	9
technical information	34
Plexo weatherproof boxes	
features information	9
IP 55 – IK07	37
IP 55 – IK07 class II	38
IP 55 – IK07 PVC increased depth	40
IP 66 – IK08 class II	38
selection chart	36
technical information	39 to 41
Plugs and sockets	
Hypra IP 44	172 to 179
Hypra IP 44/55 Prisinter	168 to 171

Hypra IP 66/67-55	180 to 185
P17 Tempra IP 44	186 to 191
P17 Tempra IP 66/67	192 to 195
Power contactors	
signalling auxiliaries	114
with 24 V coil	114
with 230 V coil	114
technical information	115
Power supplies (filtered)	
electrical characteristics	113
single phase	112
technical information	112
Prisinter (Hypra)	168 to 169
Programmable time switches	
AlphaRex ³ time switches	120 to 122
Push buttons	116

R

RCBOs	
DX 10 kA and auxiliaries	84
dimensions	88
RCDs	
DX 230 and 400 V and auxiliaries	83
dimensions	88
Rex control switches	
AlphaRex ³ Astro light control digital	120
AlphaRex ³ digital	120
AlphaRex ³ digital technical information	121 to 122
EconoRex analogue	126
Electronic time-lag switch	127
MaxiRex analogue surface and panel mounting	126
MaxiRex digital surface and panel mounting	124
Microlux D light sensitive switch	127
MicroRex analogue for rail	125
MicroRex D digital for rail	123

S

Starfix	
ferrules	160
crimping tools	160
applicators	161
technical information	161
Stainless steel enclosures (Atlantic)	
crosspieces	23
equipment and fixing accessories	26
features information	8
insulated modular chassis	25
internal doors	25
locking accessories	28
sectioned uprights	26
selection chart	10 to 11
stainless steel enclosures	16
technical information	16 to 17
wall mounting brackets	16
Steel enclosures (Atlantic-E)	
Cabstop plates	14
crosspieces	26
equipment and fixing accessories	26
features information	12 to 13
insulated modular chassis	25
internal doors	25
locking accessories	14
plinths	14
roofs	14
sectioned uprights	26
selection chart	10 to 11
steel enclosures	14
technical information	15
wall mounting brackets	14

T

Tempra (P17) plugs and sockets	
IP 44 appliance inlets	189
IP 44	189
IP 66/67	192
Terminal shield boxes	35
Terminal blocks (Viking 3)	
accessories for terminal blocks	140 to 141
heavy duty terminal blocks	147 to 148
marking label sheets	154
marking system (CAB 3)	154 to 156
selection chart – heavy duty	146
selection chart – screw connection	132 to 133
selection chart – spring connection	136 to 137
technical information	142 to 145, 149
terminal blocks with screw connection	134 to 135
terminal blocks with spring connection	138 to 139
Terminal strips	
Nylbloc	41

Time switches	
AlphaRex ³ Astro light control digital	120
AlphaRex ³ digital	120
AlphaRex ³ digital technical information	121 to 122
EconoRex analogue	126
Electronic time-lag switch	127
MaxiRex analogue surface and panel mounting	126
MaxiRex digital surface and panel mounting	124
Microlux D light sensitive switch	127
MicroRex analogue for rail	125
MicroRex D digital for rail	123
Totalising hour counters	86
Transcab open slot panel trunking	48 to 51
Transformers	
bell transformers	116
compact transformers	108
control transformers	106
how to calculate rated power	110
power supplies	112
protection of circuits	111
safety transformers	116 to 117
Type A distribution boards	
accessories	61
metal with 100 A switch disconnecter	61
technical information	61
Type B distribution boards and devices	
accessories	59
flexible 125 A and 250 A busbar	58
standard 125 A and 250 A busbar	58
selection chart	56 to 57
technical information	60

U

Universal plates for wall mounting enclosures	
technical information	24

V

Viking 3	
accessories for terminal blocks	140 to 141
features information	130 to 131
heavy duty terminal blocks	147 to 148
marking label sheets	154
marking systems CAB 3	154 to 156
selection chart – heavy duty	146
selection chart – screw connection	132 to 133
selection chart – spring connection	136 to 137
terminal blocks with screw connection	134 to 135
terminal blocks with spring connection	138 to 139
technical information	142 to 145, 149
Vistop isolating switches	
63 to 160 A	101
auxiliary switch - 250 V	101
auxiliary isolating switch - 400 V	101
technical information	102
Voltmeters	85

W

Wall mounting enclosures	
Atlantic-E steel	12
Atlantic stainless steel	16
equipment and fixing accessories	26
features information	8
Plexo ³ weatherproof IP 65	33 to 34
Plexo weatherproof boxes	36 to 41
insulated modular chassis	25
internal doors	25
locking accessories	28
Marina GRP	18
Weatherproof boxes Plexo IP 55 / 66	36 to 41
Weatherproof enclosures Plexo ³ IP 65	33 to 34

Conditions of sale

please consult our current price list

In accordance with its policy of continuous improvement, the Company reserves the right to change specifications and designs without notice. All illustrations, descriptions, dimensions and weights in this catalogue are for guidance and cannot be held binding on the Company.

Enclosures and equipment

Atlantic-E steel



P. 10
Selection chart

Atlantic stainless steel



P. 10
Selection chart

Marina GRP



P. 10
Selection chart

Equipment and locking accessories

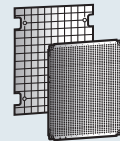

P. 23
Universal plates

Ventilation and heating for enclosures

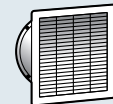

P. 29
Ventilation for enclosures

Plexo³ weatherproof enclosures and terminal shield boxes

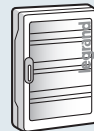

P. 33 NEW
Plexo³ weatherproof enclosures IP 65

Plexo weatherproof boxes



P. 36
Selection chart

Nylbloc terminal strips



P. 41
Nylbloc terminal strips

Distribution blocks

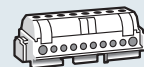

P. 42
Distribution terminal blocks

NEW IN 2012



Atlantic-E steel enclosures
IP 66
(p. 14)



Atlantic stainless steel 316 L enclosures
IP 66
(p. 16)



P. 12
Introduction to Atlantic-E steel

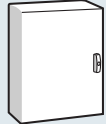

P. 14 NEW
Atlantic-E wall mounting steel enclosures IP 66 - IK 10

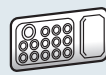

P. 14 NEW
Cabstop plates IP 55



P. 15
Technical information

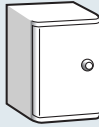

P. 16
Atlantic wall mounting 304L stainless enclosures IP 66 - IK 10

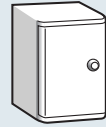

P. 16 NEW
Atlantic wall mounting 316L stainless enclosures IP 66 - IK 10



P. 16
Technical information

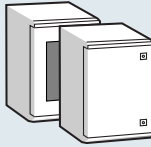

P. 18
Marina wall mounting GRP enclosures IP 66 - IK 10



P. 19
Technical information



P. 21
Marina free standing GRP enclosures IP 66 - IK 10



P. 22
Technical information

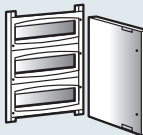

P. 25
Insulated modular chassis and internal doors

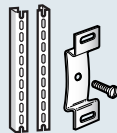

P. 26
Equipment and fixing accessories



P. 27
Technical information

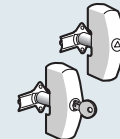

P. 28
Locking accessories



P. 30
Operating principle for ventilation

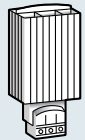

P. 31
Heating for enclosures



P. 31
Operating principle for heating



P. 32
Technical information



P. 34
Technical information

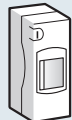

P. 35
Terminal shield boxes IP 30



P. 35
Technical information

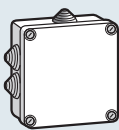

P. 37
Plexo boxes IP 55 - IK 07

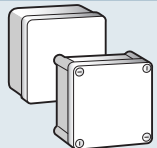

P. 38
IP 55 - IK 07/class II
IP 66 - IK 08

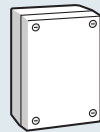

P. 40
PVC range with increased depth IP 55 - IK 07/08



P. 37, 39, 41
Technical information



P. 43
Modular distribution blocks 40 to 160 A

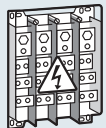

P. 44
Four pole distribution blocks 125 to 400 A

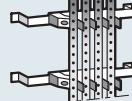

P. 45
Equipment for self assembly distribution blocks



P. 42, 43, 44, 45
Technical information



Plexo³ weatherproof enclosures

IP 65
(p. 33)

The right enclosure for your environment

Legrand's range of industrial enclosures has been designed to the highest specification, providing the user with much more than just a box

STEEL



NEW

Atlantic-E

Suitable for non-corrosive commercial and industrial environments.

FEATURES -

- Full range of 27 sizes
- Complete with removable mounting plate
- Optional heavy duty mounting brackets
- Dual locks on larger sizes

TECH DATA -

IP66 in accordance with IEC EN 60529
IK10 in accordance with IEC EN 62260

STAINLESS STEEL



Atlantic stainless steel

Suitable for corrosive environments and those requiring rigorous hygiene (eg food industry).

FEATURES -

- Available in 9 sizes
- 304L and 316L grade steel options
- Reversible enclosure with rounded door and protective flange
- Double bar locks

TECH DATA -

IP66 in accordance with IEC EN 60529
IK10 in accordance with IEC EN 62260
Nema 4x

GRP



Marina

Suitable for saline atmospheres or other corrosive environments.

FEATURES -

- Available in 11 sizes
- Wall mounting and free standing options
- Reversible plain or glass window door - 180° opening
- Dual locks on larger sizes

TECH DATA -

IP66 in accordance with IEC EN 60529
IK10 in accordance with IEC EN 62260

Seamless integration with Legrand's extended family

With high quality products throughout its product portfolio, Legrand is in an unbeatable position... offering integrated solutions designed to meet your needs whatever the budget or installation requirements.



DIN rail equipment
see p. 98 to 127



Transformers
see p. 104 to 111

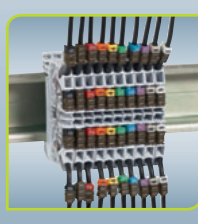

Viking 3 terminals
see p. 130 to 149



Starfix ferrules & tools
see p. 160 to 161

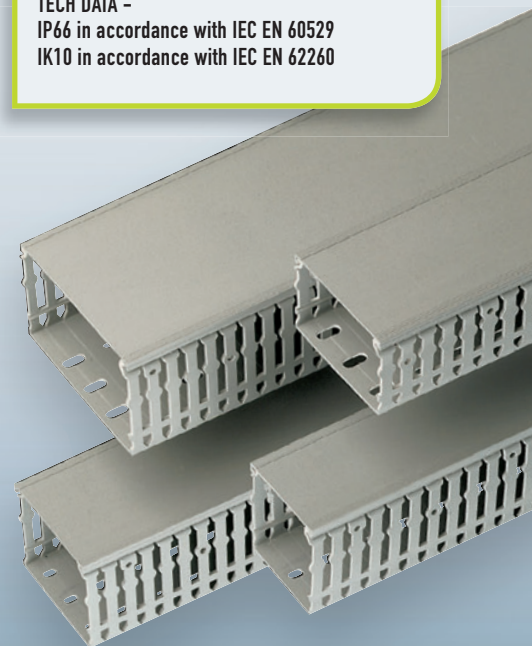

Transcab open slot
panel trunking see p. 48 to 51

WEATHERPROOF ENCLOSURES



NEW

Plexo³

Suitable for a multitude of indoor and outdoor applications.

FEATURES -

- Available in 11 sizes
- Fully reversible door and enclosure
- Lockable door handle
- Sealable cover and face plate
- Optimised cable runs and organisation

TECH DATA -

IP66 in accordance with IEC EN 60529
IK09 in accordance with IEC EN 62260
Conform to EN 60439-3

WEATHERPROOF BOXES



Plexo 66 / Plexo 55

Suitable for a multitude of indoor and outdoor applications.

FEATURES -

- Quarter turn fixings
- Halogen free
- Plain and transparent cover options
- Rail or plain plate equipment mounting

TECH DATA -

IP66 in accordance with IEC EN 60529
IK09 in accordance with IEC EN 62260
Polycarbonate, polypropylene, PVC and polystyrene boxes



NEW Atlantic-E... ready and set for you to go

This new robust range of steel wall mounting enclosures is the latest addition to Legrand's extensive industrial product portfolio.

Each enclosure is supplied ready to use with removable plain mounting plate and can be used in conjunction with a variety of time-saving accessories, including: Cabstop weatherproof cable glands, Lina 25 perforated plates and Transcab open slot panel trunking.

See p. 12

Atlantic-E, Atlantic and Marina enclosures and equipment

selection chart

EXTERNAL DIMENSIONS (nominal)				ATLANTIC-E ENCLOSURES	ATLANTIC ENCLOSURES		MARINA ENCLOSURES			
				STEEL IP 66 - IK 10 WALL MOUNTING GREY RAL 7035 	STAINLESS STEEL IP 66 - IK 10 WALL MOUNTING Stainless 304 L Stainless 316 L 		POLYESTER (GRP) IP 66 - IK 10 WALL MOUNTING GREY RAL 7035 GREY RAL 7035 with window FREE STANDING GREY RAL 7035			
				Shapes H (mm) W (mm) D (mm)				All supplied with plain plate		
	300	200	150	0399 30	-	-	-	-	-	
	400	300	150	0399 34	-	-	-	-	-	
	500	400	150	0399 38	-	-	-	-	-	
	300	200	160	-	0352 00 Supplied with plain plate	0352 40 Supplied with plain plate	0362 50	-	-	
	400	300	200	0399 35	0352 01	0352 41	0362 51	0362 71	-	
	500	400	200	0399 39	0352 02	0352 42	0362 52	0362 72	-	
	600	400	200	0399 42	0352 03	-	-	-	-	
	600	500	200	0399 44	-	-	-	-	-	
	700	500	200	0399 51	-	-	-	-	-	
	800	600	200	0399 54	-	-	-	-	-	
	500	400	250	0399 40	-	-	-	-	-	
	600	400	250	0399 43	0352 05	0352 45	0362 55	0362 75	-	
	600	500	250	0399 45	-	-	-	-	-	
	700	500	250	0399 52	0352 06	0352 46	0362 56	0362 76	-	
	800	600	250	0399 55	-	-	-	-	-	
	1000	800	250	0399 64	-	-	-	-	-	
	800	600	300	0399 56	0352 11	0352 47	0362 61	0362 81	-	
	1000	600	300	0399 63	-	-	-	-	-	
	1000	800	300	0399 65	0352 13	0352 53	0362 63	-	-	
	1200	800	300	0399 69	0352 14	-	0362 64	-	-	
1400	800	400	-	0352 15	-	-	-	-		
1460	800	463	-	-	-	-	-	0362 85		
1660	800	463	-	-	-	-	-	0362 86		
1860	800	463	-	-	-	-	-	0362 87		
	300	300	150	0399 31	-	-	-	-	-	
	300	300	200	0399 32	-	-	-	-	-	
	400	400	200	0399 36	-	-	-	-	-	
	500	500	250	0399 41	-	-	-	-	-	
	600	600	250	0399 46	-	-	-	-	-	
	800	800	300	0399 59	-	-	-	-	-	
	300	400	200	0399 33	-	-	-	-	-	
	400	600	250	0399 37	-	-	-	-	-	

(1) Atlantic-E enclosures are supplied complete with removable mounting plate (2) Requires Cat. No. 0363 69 when mounting in Atlantic stainless steel (see p. 25)
 (3) Galvanised steel (4) Pre-galvanised steel
 (A) For Atlantic stainless steel (M) For Marina (E) For Atlantic-E

EQUIPMENT										ASSOCIATED PRODUCTS
Plain plates (not compatible with Atlantic-E enclosures) (1) (4)	Lina 12-5 perforated plates ⁽⁴⁾	Lina 25 perforated plates ⁽⁴⁾	Modular chassis	Internal doors (not compatible with Atlantic-E enclosures)	Lina 25 sectioned uprights	Lina 25 crosspieces	Roofs (not compatible with Atlantic stainless steel enclosures)	Plinths	IP 55 Cabstop (direct mounting on cable entry of Atlantic-E enclosures)	
–	0360 00	0360 07	–	–	0361 50	–	–	–	–	Document pocket (p. 26)
–	0360 04	0360 12	–	–	0361 51	0367 80	–	–	–	
–	0360 09	0360 15	–	–	0361 52	0367 81	–	–	–	Perforated plates (p. 23)
0360 49 ^(M) 0360 50 ^(A)	0360 00 ^(A) 0360 01 ^(M)	0360 07 ^(A) 0360 09 ^(M)	–	–	0361 50 ^(A)	–	–	–	–	
0360 52	0360 04	0360 12	0361 01	0363 59 ⁽²⁾	0361 51	0367 80	0365 51 ^(E)	–	–	Locking accessories (p. 28)
0360 55	0360 09	0360 15	0361 02	0363 60 ⁽²⁾	0361 52	0367 81	0365 52 ^(E)	–	0364 95 ^(E)	
0360 56	0360 22	0360 16	–	0363 61 ⁽²⁾	0361 53	0367 81	0365 52 ^(E)	–	0364 95 ^(E)	Ventilation kits (p. 29)
–	–	–	–	–	0361 53	0367 82	0365 59	–	0364 95	
–	0360 31	0360 18	–	–	0361 54	0367 82	0365 59	–	0364 95	Heaters and thermostat (p. 31)
–	0360 33	0360 19	–	–	0361 55	0367 83	–	–	0364 95	
–	0360 09	0360 15	–	–	0361 52	0367 81	0365 53	–	0364 95	Chassis kits (p. 25)
0360 56	0360 22	0360 16	0361 03	0363 61 ⁽²⁾	0361 53	0367 81	0365 53 ^(E)	–	0364 95 ^(E)	
–	–	–	–	–	0361 53	0367 82	0365 64	–	0364 95	
0360 58	0360 31	0360 18	0361 05	0363 62 ⁽²⁾	0361 54	0367 82	0362 93 ^(M) 0365 64 ^(E)	–	0364 95 ^(E)	
–	0360 33	0360 19	–	–	0361 55	0367 83	–	–	0364 97	
–	0360 42	0360 21	–	–	0361 56	0367 84	–	–	0364 97	
0360 59	0360 33	0360 19	0361 06	0363 63 ⁽²⁾	0361 55	0367 83	0365 56 ^(E) 0362 94 ^(M)	0363 00 ^(E) 0362 91 ^(M)	0364 97 ^(E)	
–	0360 40	0360 23	–	–	0361 56	0367 83	0365 56	0363 00	0364 97	
0360 61	0360 42	0360 21	0361 09	0363 64 ⁽²⁾	0361 56	0367 84	0365 57 ^(E) 0362 95 ^(M)	0363 01 ^(E) 0362 92 ^(M)	0364 97 ^(E)	
0360 64	0360 46	0360 87	0361 10	0363 65 ⁽²⁾	0361 58	0367 84	0365 57 ^(E) 0362 95 ^(M)	0363 01 ^(E) 0362 92 ^(M)	0364 97 ^(E)	
0360 67	0360 75	0360 90	–	–	0361 59	0367 84	–	–	–	
0349 59 ⁽³⁾	–	–	–	–	0363 90	–	0362 97	0362 96	–	
0349 50 ⁽³⁾	–	–	–	–	0363 91	–	0362 97	0362 96	–	
0344 18 ⁽³⁾	–	–	–	–	0363 92	–	0362 97	0362 96	–	
–	0360 02	0360 91	–	–	0361 50	0367 80	–	–	–	
–	0360 02	0360 91	–	–	0361 50	0367 80	0365 51	–	–	
–	0360 05	0360 92	–	–	0361 51	0367 81	0365 52	–	0364 95	
–	0360 14	0360 93	–	–	0361 52	0367 82	0365 64	–	0364 95	
–	0360 24	0360 17	–	–	0361 53	0367 83	0365 54	–	0364 97	
–	0360 34	0360 20	–	–	0361 55	0367 84	0365 57	0363 01	0364 97	
–	0360 04	0360 12	–	–	0361 50	0367 81	0365 52	–	0364 95	
–	0360 22	0360 16	–	–	0361 51	0367 83	0365 54	–	0364 97	

Atlantic-E...

as strong as steel



This new robust range of steel wall mounting enclosures is the latest addition to Legrand's extensive industrial product portfolio. Atlantic-E has been designed to the highest specification and incorporates a number of innovations that make installation faster and easier than ever before.

Designed with the installer in mind

Save time on installation... each Atlantic-E enclosure is supplied ready to use with a removable plain mounting plate, cable entry plate, earth connection braid and wall mounting brackets.

Flexible and reliable... doors are easy to remove, are fully reversible if required, and offer a 130° opening for easy access inside the enclosure. Innovative design features provide greater strength and weatherproofing to ensure a long-lasting installation.

- Full range of 27 sizes (up to 1200 x 800 x 300 mm)
- Supplied complete with removable mounting plate
- IP 66 weatherproof seal
- IK 10 - maximum protection against mechanical impact
- Dual locks on larger sized enclosures provide additional security
- Optional mounting brackets for heavy loads



Optional features and fully compatible products extend your choices

With a wide selection of accessories and equipment available, Atlantic-E enclosures can easily be tailored to the specific requirements of each application.



Heavy duty mounting brackets
see p. 14

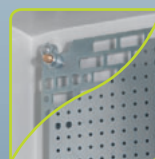

Mounting plate options
see p. 23

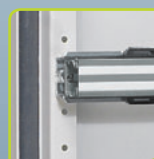

Transcab panel trunking
see p. 48 to 51



Viking 3 terminal blocks
see p. 130 to 149



Sectioned uprights - provide greater door strength and mounting holes for cable trunking

Weatherproof seal - polyurethane seal for greater reliability and total weatherproofing to IP 66 (or IP 55 with Cabstop plate)

Mounting brackets - wall mounting brackets supplied with enclosure. Optional mounting brackets for heavy loads available

Removable plain mounting plate - provides maximum usable space and an easy method of fixing equipment directly. Optional perforated plates or ready to use chassis available

Removable cable entry plate - fully weatherproof polyurethane seals aligned with the base of the enclosure for a high quality finish. Can be equipped with cable glands or replaced with Cabstop plate for fast weatherproof cable entry

Double bar locks - ensure a totally weatherproof seal. Supplied with double bar key. Alternative locks available

Reversible door - easy to remove. With metal hinges for guaranteed strength. Opens to 130° for easier access inside the enclosure

130°

Atlantic-E steel wall mounting enclosures

IP 66 - IK 10

NEW



0399 30



0399 35



0399 43



0365 53

Technical information and dimensions (p. 15)
Equipment (p. 23-32)

Pack	Cat. Nos.	Steel enclosures			
		Grey RAL 7035 IP 66 according to IEC 60529 IK 10 according to IEC 62262, EN 50102 Supplied with : galvanised plain mounting plate (removable), earth connection braid and wall mounting brackets Reversible door Supplied with one double bar lock up to 500 x 500 x 250 mm and 2 double bar locks from 600 x 400 x 150 mm Removable cable entries plate Can be equipped with Cabstop plates Can be equipped with Lina 12.5 and Lina 25 perforated plates, sectioned uprights, DIN rail or chassis with insulating faceplates (p. 23-26) 80 µ thick textured polyester coating			
		Dimensions (mm)			
		Height	Width	Depth	Weight (kg)
1	0399 30	300	200	150	4.5
1	0399 31	300	300	150	4.7
1	0399 32	300	300	200	4.8
1	0399 33	300	400	200	6.7
1	0399 34	400	300	150	6.25
1	0399 35	400	300	200	6.7
1	0399 36	400	400	200	10.5
1	0399 37	400	600	250	13.5
1	0399 38	500	400	150	11
1	0399 39	500	400	200	11.5
1	0399 40	500	400	250	12
1	0399 41	500	500	250	12.5
1	0399 42	600	400	200	13
1	0399 43	600	400	250	13.5
1	0399 44	600	500	200	16
1	0399 45	600	500	250	16.5
1	0399 46	600	600	250	17
1	0399 51	700	500	200	20
1	0399 52	700	500	250	21
1	0399 54	800	600	200	27
1	0399 55	800	600	250	30
1	0399 56	800	600	300	31.7
1	0399 59	800	800	300	33.5
1	0399 63	1000	600	300	48
1	0399 64	1000	800	250	49.5
1	0399 65	1000	800	300	52
1	0399 69	1200	800	300	62

		Roofs		
		Grey RAL 7035 Steel Possible adjustment ±20 mm (front or back)		
		For enclosures		
		Width (mm)	Depth (mm)	Weight (kg)
1	0365 51	300	200	1.2
1	0365 52	400	200	1.4
1	0365 53	400	250	1.8
1	0365 64	500	250	2
1	0365 54	600	250	2.5
1	0365 56	600	300	3
1	0365 57	800	300	3.6

Pack	Cat. Nos.	Plinths			
		Anthracite grey RAL 7021 Height 200 mm Front and rear trap door For 300 mm deep enclosures			
		Enclosure width (mm)		Weight (kg)	
1	0363 00	600		6	
1	0363 01	800		6.7	
		Cabstop plates IP 55			
		Open-work plates			
		Grey RAL 7035 Cable entries consisting of a cable clamp providing the mechanical grip, and elastomer areas for weatherproofing Can be pierced using the cable (no tool required) Fits the cable perfectly Replacement of a cable possible Fire retardant polypropylene Supplied with : - locking caps for sealing a pierced entry providing IP 55 protection - cable release tool			
		Number of entries ø5 to 14 (mm)	Number of entries ø14 to 24 (mm)	Number of spare entries	Direct mounting on cable entry of Atlantic-E enclosure width (mm)
1	0364 95	13	1	1	400
1	0364 97	28	2	2	600-800-1200
		Wall mounting brackets			
		Grey RAL 7035 For heavy loads up to 300 kg Horizontal or vertical installation With a roof, horizontal installation only Zamak Supplied with cover			
1	0364 01	Set of 4			
		Locking accessories			
		Metal rebate lock barrels			
10	0399 80	6 mm female square			
10	0399 81	8 mm male triangle			
		Keys for rebate locks			
10	0365 35	6 mm female square			
10	0365 40	8 mm male triangle			
		Key barrels			
		Supplied with set of 2 keys			
		For key No :			
10	0399 86	405			
10	0399 87	455			
10	0399 88	2433 A			
10	0365 45	Set of two 2433 A keys			



For Lina 12.5 and Lina 25 perforated plates see p. 23
For modular chassis see p. 25
For sectioned uprights see p. 26
For crosspieces see p. 26

Atlantic-E steel wall mounting enclosures

IP 66 - IK 10

■ Fixing dimensions

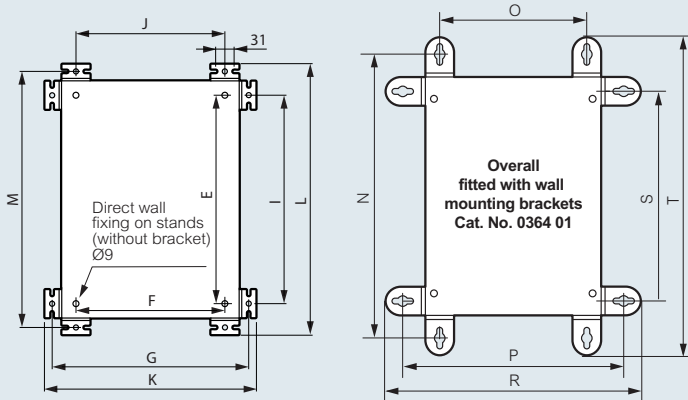

Enclosures		Vertical brackets		Mounting centres		Horizontal brackets		Mounting centres		Overall		Overall with 0364 01		Vertical brackets		Horizontal brackets	
H (mm)	W (mm)	M (mm)	J (mm)	E (mm)	I (mm)	G (mm)	F (mm)	L (mm)	K (mm)	T (mm)	R (mm)	N (mm)	O (mm)	P (mm)	S (mm)	T (mm)	S (mm)
300	200	330	150	250	250	230	150	356	256	430	330	375	150	275	250		
300	300	330	250	250	250	330	250	356	356	430	430	375	250	375	250		
300	400	330	350	250	250	430	350	356	456	430	530	375	350	475	250		
400	300	430	250	350	350	330	250	456	356	530	430	475	250	375	350		
400	400	430	350	350	350	430	350	456	456	530	530	475	350	475	350		
400	600	430	550	350	350	530	550	456	656	530	730	475	550	575	350		
500	400	530	350	450	450	430	350	556	456	630	530	575	350	475	450		
500	500	530	450	450	450	530	450	556	556	630	630	575	450	575	450		
600	400	630	350	550	550	430	350	656	456	730	530	675	350	475	550		
600	500	630	450	550	550	530	450	656	556	730	630	675	450	575	550		
600	600	630	550	550	550	630	550	656	656	730	730	675	550	675	550		
700	500	730	450	650	650	530	450	756	556	830	630	775	450	575	650		
800	600	830	550	750	750	630	650	856	656	930	730	875	550	675	750		
800	800	830	750	750	750	830	750	856	856	930	930	875	750	875	750		
1000	600	1030	550	950	950	630	550	1056	656	1130	730	1075	550	675	950		
1000	800	1030	750	950	950	830	750	1056	856	1130	930	1075	750	875	950		
1200	800	1230	750	1150	1150	830	750	1256	856	1330	930	1275	750	875	1150		

■ Usable depth

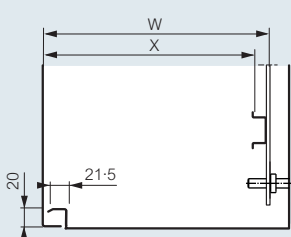

Enclosures depth (mm)	Back of enclosures	
	W (mm)	X (mm)
150	130	115
200	180	165
250	230	215
300	280	265

■ Doors : usable area dimensions

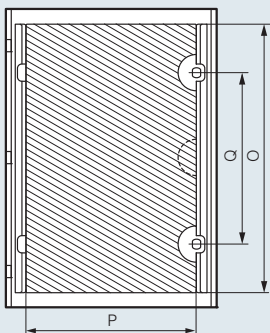

Enclosures H x W (mm)	Door usable space			Locking position Q (mm)
	Height O (mm)	Width P (mm)	Area (dm ²)	
300 x 200	251	80	2.0	(1)
300 x 300	251	180	4.5	(1)
300 x 400	251	280	7.0	(1)
400 x 300	351	180	6.3	(1)
400 x 400	351	280	9.8	(1)
400 x 600	351	480	16.8	(1)
500 x 400	425	280	11.9	(1)
500 x 500	425	380	16.1	(1)
600 x 400	525	280	14.7	350(2)
600 x 500	525	380	19.9	350(2)
600 x 600	525	480	25.2	350(2)
700 x 500	625	380	23.7	450(2)
800 x 600	725	480	36.0	550(2)
800 x 800	725	680	49.3	550(2)
1000 x 600	925	480	44.4	750(2)
1000 x 800	925	680	62.9	750(2)
1200 x 800	1125	680	76.5	950(2)

(1) Central lock
(2) Top and bottom lock

■ Roof fixing position

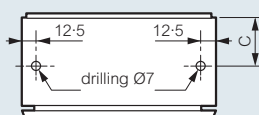

Cat. Nos.	C (mm)
0365 51/52	100
0365 53/54/64	125
0365 56/57	150

■ Plinths

Trap doors

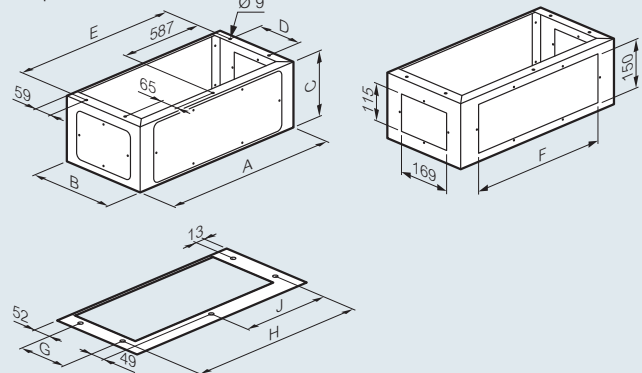

Cat. Nos.	Enclosures W x D (mm)	A	B	C	D	E	F	G	H	J
0363 00	600 x 300	600	280	200	150	574	469	150	542	271
0363 01	800 x 300	800	280	200	150	774	469	150	742	371

■ Cable entry plate

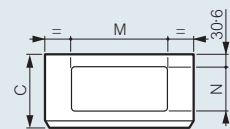

Enclosures (mm)	Dimensions of cable entries (mm)	
	W	D
200	150	155
300	150	155
300	200	205
400	150	155
400	200	205
400	250	255
500	200	205
500	250	255
600	200	205
600	250	255
600	300	305
800	250	255
800	300	305

■ Cabstop plates IP 55

- Tensile resistance : 15 kg minimum
- Operating temperature : -20 °C to +65 °C
- ASTM No 3 resistance to cutting oil
- Resistance to incandescent wire : 750 °C according to IEC EN 60695-2-11

Cable entry Ø14 to 24 mm equivalent CG PG 21/29 ISO 25/32

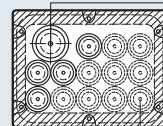

Cable entry Ø5 to 14 mm equivalent CG PG 9/11/13/16 ISO 16/20

Cat. No. 0364 95

Side view

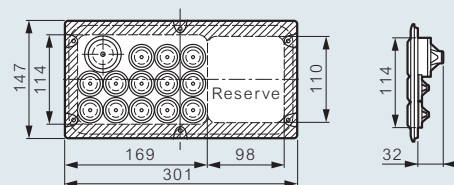

Cat. No. 0364 97

Side view

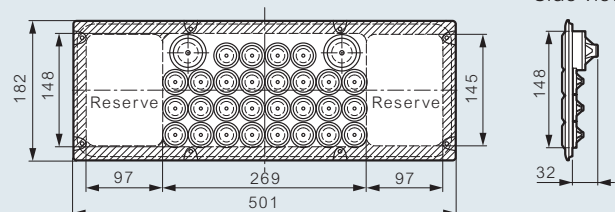

Atlantic stainless steel wall mounting enclosures

IP 66 - IK 10 - Nema 4x



Technical information and dimensions (opposite) Equipment (p. 23-32)

IP 66 according to IEC 60529
 IK 10 according to IEC 62262, EN 50102
 UL listed (Nema 4x)
 CSA, Bureau Veritas, LRS. LCIE N° 170 790 10A
 Stainless steel 304 L, 316 L
 Upper and lower protective hoods
 Door with rounded vertical sides

For use in :

• **areas requiring a high level of hygiene :**

- food processing plants and dairies
- industrial/commercial kitchens

• **corrosive conditions :**

- chemical plants
- pharmaceutical, petroleum and paper industries

• **very harsh environments :**

- industrial; acid or acid fumes
- offshore; naval; chlorides present

Automatic positioning of equipment on to active corners with M8 fixings
 Provision to fix optional runners and brackets for depth adjustment in enclosures from 600 x 400 x 250 mm (contact us on +44 (0) 845 605 4333)

Pack **Cat. Nos.** **Stainless steel enclosures⁽¹⁾ – 304 L (1 door)**

Pack	Cat. Nos.	External dimensions (mm)			Weight (kg)
		Height	Width	Depth	
1	0352 00 ⁽¹⁾⁽²⁾	300	200	160	4
1	0352 01 ⁽¹⁾	400	300	200	5-8
1	0352 02	500	400	200	8-3
1	0352 03	600	400	200	10-8
1	0352 05	600	400	250	12
1	0352 06	700	500	250	15
1	0352 11	800	600	300	22
1	0352 13	1 000	800	300	38
1	0352 14	1 200	800	300	45
1	0352 15	1 400	800	400	66

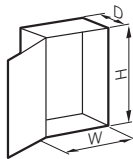

Stainless steel enclosures – 316 L (1 door)

Supplied with non-interchangeable double bar lock
 Epoxy finish. Steel coated
 Locking points : 1 lock for heights ≤ 400 mm
 2 locks for heights ≥ 500 mm

Pack	Cat. Nos.	External dimensions (mm)			Weight (kg)
		Height	Width	Depth	
1	0352 40 ⁽²⁾	300	200	160	4
1	0352 41	400	300	200	5-8
1	0352 42	500	400	200	8-3
1	0352 45	600	400	250	12
1	0352 46	700	500	250	15
1	0352 47	800	600	300	22
1	0352 53	1 000	800	300	38

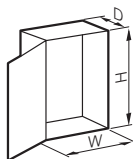

Wall mounting brackets

Supplied with stainless steel screws
 Horizontal or vertical installation
 Set of 4
 Upto max. load 300 kg

1	0364 06	304 L
1	0364 16	316 L

(1) Cat. Nos. 0352 00/01 are fitted with 1 lock, all others are fitted with 2 locks
 (2) Supplied with plain plate

Atlantic stainless steel wall mounting enclosures

IP 66 - IK 10 - Nema 4x

■ **Technical information**

Stainless steel enclosures provide a solution in harsh, aggressive environments such as chemical plants or offshore

Corrosion resistance

	304 L	316 L
To salt spray (SS)	1 000 hrs	2 000 hrs
To sulphur dioxide (SO ₂)	500 hrs	1 000 hrs

Brushed stainless steel finish

Polygrain 180
 - Ra 0.25 to 0.35 µm
 - Rt 2.5 to 4 µm

Stainless steel properties

304 L : Provides good resistance to :

- nitric acid at concentrations of 52 % or less at all temperatures (or 98 % when cold)
- cold dilute organic acids
- alkaline solutions (unless hot or above 50 %)
- saline solutions except chlorides, sulphides and sulphates
- fresh water and natural atmosphere low in chlorides
- food products (except mustard and white wine)

316 L : Provides good resistance to :

- phosphoric acids - all concentrations ≤ 40 °C
- sulphuric acids < 10 % and > 80 % at 20 °C
- sulphuric compounds ≤ 70 °C
- sulphuric vapours and solutions, even boiling
- salt solutions except chloride
- alkaline solutions - all concentrations < 100 °C
- fresh water and natural atmosphere (particularly marine conditions)
- organic, food and pharmaceutical compounds

Physical properties

Specific weight - density : 8
 Coefficient of expansion : 16 µ / m °C
 Specific heat : 500 J / kg °C
 Electrical resistivity : 0.75 µΩ mm²
 Thermal conductivity : 15 W / m °C

The only way of guaranteeing excellent resistance to intercrystalline corrosion is the low carbon content (0.03 %) of 304 L and 316 L stainless steel

Different country names

		304 L	316 L
France	AFNOR NFEN	Z3 CN 18-10 X 2 CNI 19-11	Z3 CND 17-11-02 X 2 CNI Mo 17-12-2
Germany	DIN	X 2 CNI 19-11 (W.Nr 1-4 306)	X 2 CNI Mo 17-13-2 (W.Nr 1-4 404)
USA	AISI	304 L	316 L

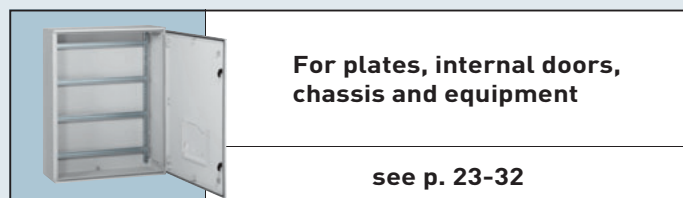

For plates, internal doors, chassis and equipment

see p. 23-32

Atlantic stainless steel wall mounting enclosures

IP 66 - IK 10 - Nema 4x

■ Dimensions

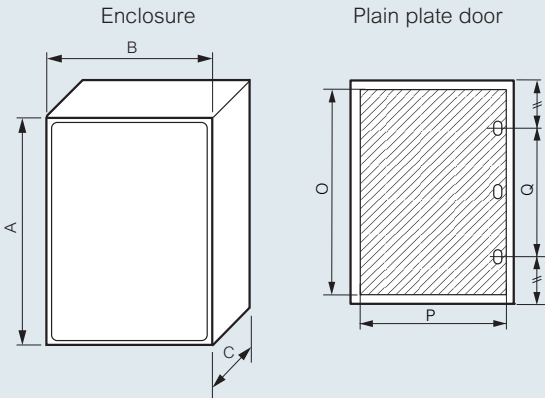

Cat. Nos.	Height	Width	Depth	Usable door surface area		Lock positions
	A (mm)	B (mm)	C (mm)	O (mm)	P (mm)	
0352 00/40	301-6	199-6	161-5	250	150	Centred
0352 01/41	401-6	299-6	201-5	350	250	Centred
0352 02/42	501-6	399-6	201-5	450	350	250
0352 03	601-6	399-6	201-5	550	350	380
0352 05/45	601-6	399-6	251-5	550	350	380
0352 06/46	702-4	500	251-5	650	450	400
0352 11/47	802-4	600	301-5	750	550	400
0352 13/53	1003-6	800-6	301-5	950	750	600
0352 14	1203-6	800-6	301-5	1150	750	700
0352 15	1400-6	800-6	401-5	1350	750	900

Note : Dimension C does not include lock
Lock thickness = 4 mm

■ Fixing positions for wall mounting brackets

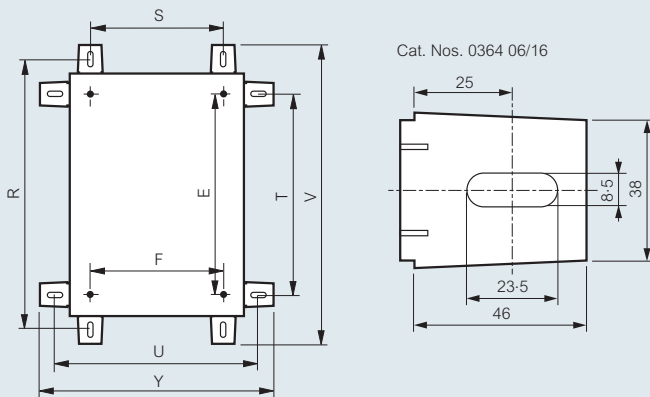

Cat. Nos.	Vertical wall brackets		Horizontal wall brackets		Dimensions			
	R (mm)	S (mm)	T (mm)	U (mm)	V (mm)	Y (mm)	E (mm)	F (mm)
0352 00/40	353	150	250	250	395	292	225	169
0352 01/41	453	250	350	350	495	392	325	269
0352 02/42	553	350	450	450	595	492	425	369
0352 03	653	350	550	450	695	492	525	369
0352 05/45	653	350	550	450	695	492	525	369
0352 06/46	753	450	650	550	795	592	625	469
0352 11/47	853	550	750	650	895	692	725	569
0352 13/53	1053	750	950	850	1095	892	925	769
0352 14	1253	750	1150	850	1295	892	1125	769
0352 15	1450	750	1350	850	1492	892	1325	769

Position of equipment

without runners

For runners, contact us on +44 (0) 845 605 4333

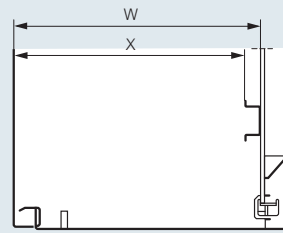

Enclosure Depth (mm)	Without runners	
	W (mm)	X (mm)
160	140	125
200	180	165
250	230	215
300	280	265
400	380	365

For mounting plates, see p. 26

Active corner

Provides quick and easy fixing

Transfers equipment weight to wall fixings

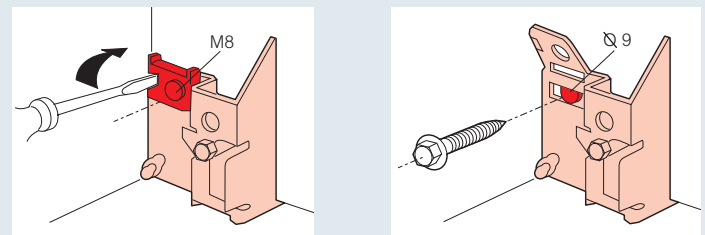

Fixing method for runners and depth adjustment brackets

Contact us on +44 (0) 845 605 4333

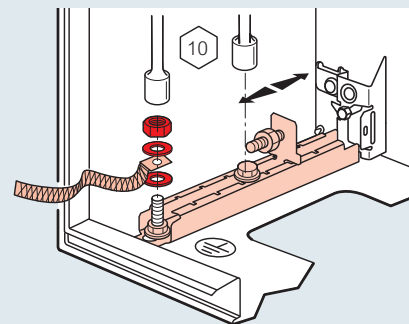

Marina wall mounting enclosures

polyester (GRP) IP 66 - IK 10



0362 56



0362 76



0362 63 + plinth Cat. No. 0362 92
+ roof Cat. No. 0362 95



0362 55 +
wall brackets Cat. No. 0364 09



0362 56
on stand Cat. No. 0364 36
and crosspieces
Cat. No. 0364 39

Technical information and dimensions (p. 19-20)
Equipment (p. 23-32)

Grey RAL 7035
IP 66 according to IEC EN 60529
IK 10 according to IEC EN 62262 (EN 50102)
Class II insulation for final assembly according to IEC EN 60439-1
Glass fibre reinforced polyester (GRP) enclosures
Self extinguishing at 960 °C according to IEC EN 60695-2-11
Designed for corrosive environments
Reversible door, 180° opening⁽¹⁾
2 x double bar locks⁽¹⁾
Captive stainless steel hinge pins⁽¹⁾
Mounting plate/equipment can be fixed directly to the rear of the enclosure
Accepts partial plate from 500 x 400 x 200 mm and/or rails⁽¹⁾
Optional depth adjustment kit (Cat. No. 0362 42) available for enclosures 400 mm high and above
For wall mounting, wall mounting brackets must be ordered separately

Pack	Cat. Nos.	GRP enclosures					
Plain door							
External dimensions (mm)							
		Height	Width	Depth	Weight (kg)		
1	0362 50	300	220	160	1.75		
1	0362 51	400	300	206	3.7		
1	0362 52	500	400	206	5.1		
1	0362 55	610	400	257	6.4		
1	0362 56	720	510	250	11.2		
1	0362 61	820	610	300	15.2		
1	0362 63	1020	810	300	21.8		
1	0362 64	1220	810	300	25.0		
Glazed door with tinted glass window							
External dimensions (mm)							
		Height	Width	Depth	Window (mm)	Weight (kg)	
					Height	Width	
1	0362 71	400	300	206	235	145	4.0
1	0362 72	500	400	206	335	245	5.6
1	0362 75	610	400	257	463	245	7.0
1	0362 76	720	510	250	570	272	12.3
1	0362 81	820	610	300	672	372	16.7

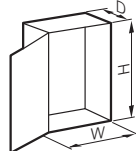

Pack	Cat. Nos.	Roofs	
IK 10			
For enclosures (mm)			
		Width	Depth
1	0362 93	500	250
1	0362 94	600	300
1	0362 95	800	300

Pack	Cat. Nos.	Plinths	
Height 170 mm Front and rear trap door Possibility to overlap 2 plinths			
For enclosures (mm)			
		Width	Depth
1	0362 91	600	300
1	0362 92	800	300

Pack	Cat. Nos.	Fixing accessories	
IP 66 maintained			
Wall mounting brackets Set of 4, supplied with screws			
For enclosures			
		Height (mm)	Max. load (kg)
1	0364 08	300	100
1	0364 09	400 to 1 200	150
Rear with threaded rod M8 for enclosures height ≥ 400 mm Mounting at back of enclosures			
10	0362 40		
On ground Stand comprised of 2 feet for fixing enclosures high up Supplied with fixing screws Hot galvanised steel Conform to EN 50125-3 (railway applications, fixed installations)			
For enclosures			
		Height (mm)	
1	0364 36	400 to 800	
1	0364 37	1 000 to 1 200	
1	0364 39	Anti-tipping crosspieces	

Pack	Cat. Nos.	Accessories	
1	0362 42	Depth adjustment kit for enclosures ≥ 200 mm 4 fixings complete with screws	



Plain and perforated plates (see p. 23)

Modular chassis (see p. 25)

Internal doors (see p. 25)

Sectioned uprights (see p. 26)

Crosspieces (see p. 26)

Locking accessories (see p. 28)

(1) Except Cat. No. 0362 50

Marina wall mounting enclosures

polyester (GRP) - IP 66 - IK 10

Dimensions, usable areas

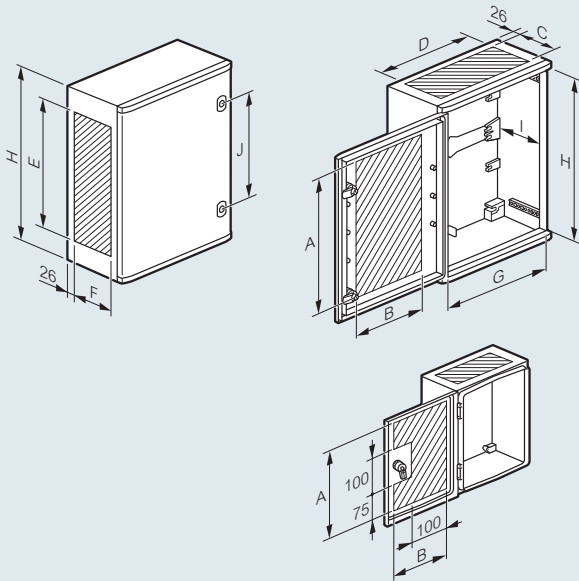

Cat. Nos.	Usable dimensions (mm)									
	A ⁽¹⁾	B ⁽¹⁾	C	D	E	F	G	H	I max.	J
0362 50	250	150	105	195	250	115	194	280	130	-
0362 51/71	300	180	130	250	260	150	260	350	178	200
0362 52/72	400	280	130	350	360	150	360	450	178	300
0362 55/75	500	280	180	350	460	180	360	560	225	400
0362 56/76	600	340	170	400	560	170	460	662	211	400
0362 61/81	700	440	220	500	660	230	560	762	261	500
0362 63	900	600	220	700	860	230	760	962	261	580
0362 64	1100	600	220	700	1060	230	960	1162	261	700

(1) Except for enclosures with glass windows

Dimensions for the window (glass door)

Window centred in height and width

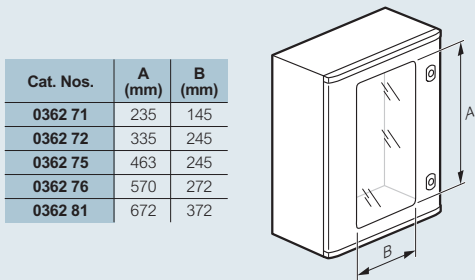

Cat. Nos.	A (mm)	B (mm)
0362 71	235	145
0362 72	335	245
0362 75	463	245
0362 76	570	272
0362 81	672	372

Roofs and plinths

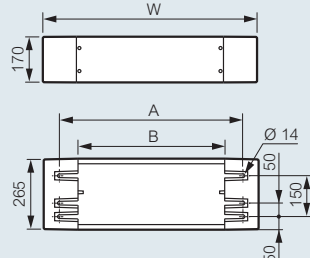
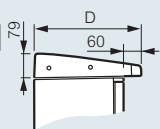

Roof Cat. Nos.	Width (mm)	D (mm)	Weight (kg)
0362 93	510	310	1
0362 94	612	360	1.3
0362 95	812	360	1.7

Plinth Cat. Nos.	W (mm)	A (mm)	B (mm)	Weight (kg)
0362 91	590	480	344	4.8
0362 92	790	680	544	5.4

Equipment fixing

Cat. Nos.	A (mm)	B (mm)	C (mm)	D (mm)	E (mm)	F (mm)
0362 50	263	163	-	-	-	-
0362 51/71	325	225	125	225	102.5	228.5
0362 52/72	425	325	225	325	87.5	228.5
0362 55/75	525	325	325	325	95	328.5
0362 56/76	625	425	425	425	100	428.5
0362 61/81	725	525	525	525	100	528.5
0362 63	925	725	725	725	100	728.5
0362 64	1125	725	925	725	100	728.5

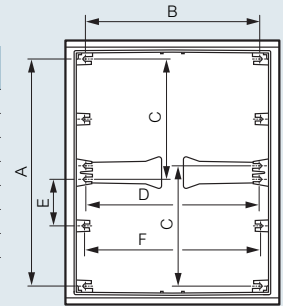

Adjustment of equipment (kit required)

Cat. Nos.	Full mounting plate (mm)		Chassis with rail (mm)	
	A max	A min (with Cat. No. 0362 42)	B max	B min (with Cat. No. 0362 42)
0362 50	135	-	-	-
0362 51/71	170	70	155	55
0362 52/72	170	70	155	55
0362 55/75	220	70	205	55
0362 56/76	220	70	205	55
0362 61/81	270	70	255	55
0362 63	270	70	255	55
0362 64	270	70	255	55

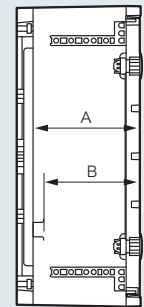

Depth adjustment using kit Cat. No. 0362 42 (except Cat. No. 0362 50)

Cat. Nos.	Thickness or wall (mm) (indicative dimensions)		
	Door	Sides	Rear
0362 50	2.5	2.5	2.5
0362 51/71	2.7	2.5	3
0362 52/72	2.7	2.5	3
0362 55/75	2.7	2.5	3
0362 56/76	4	3.5	3.5
0362 61/81	4	3.5	3.5
0362 63	4	3.5	3.5
0362 64	4	3.5	3.5

Fixing positions for mounting enclosure (maintains IP 66 and Class II)

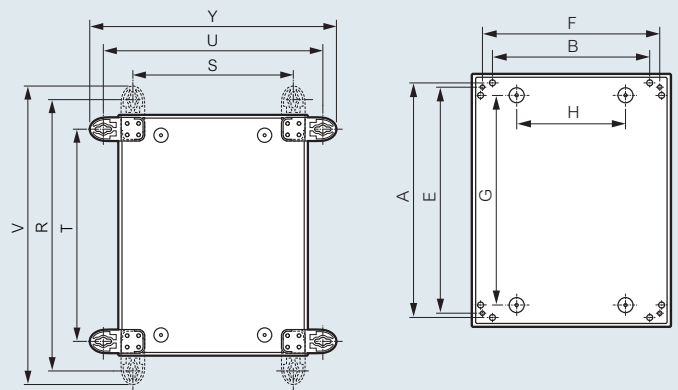

Cat. Nos.	On stand Cat. No. 0364 36 and by threaded rods (mm)		Direct fixing outside mounting equipment area and on stand Cat. No. 0364 37 (mm)		Direct fixing through rear of enclosure (mm)		With vertical brackets (mm)			With horizontal brackets (mm)		
	A	B	E	F	G	H	R	S	V	T	U	Y
0362 50 ⁽¹⁾	-	-	-	-	220	150	330	190	359	270	250	279
0362 51/71	364	218	358	259	325	120	470	241	525	341	370	425
0362 52/72	464	318	458	359	425	220	570	341	625	441	470	525
0362 55/75	574	318	558	358	525	220	680	341	735	551	470	525
0362 56/76	683	427	664	468	600	200	789	441	844	641	579	634
0362 61/81	781	525	764	568	700	300	887	548	942	758	677	732
0362 63	-	-	964	768	900	500	1087	748	1142	958	877	932
0362 64	-	-	1164	768	1100	500	1287	748	1342	1158	877	932

(1) Use Cat. No. 0364 08 wall brackets. Others use Cat. No. 0364 09 wall brackets

Marina wall mounting enclosures

polyester (GRP) - IP 66 - IK 10 (continued)

■ Wall mounting brackets

Cat. No. 0364 08
for enclosures height 300 mm

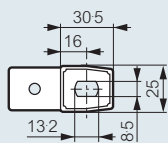

Cat. No. 0364 09
for enclosures height ≥ 400 mm

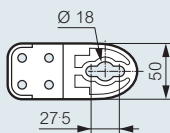

■ Wall fixing by threaded rods

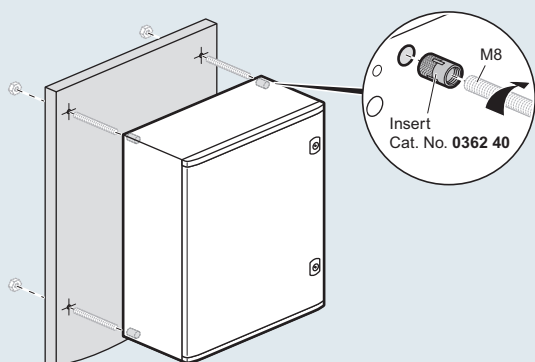

■ Floor fixing with stand

Stand
Cat. Nos. **0364 36/37**
(H 1203/1603 mm)

Anti-tipping crosspieces
Cat. No. **0364 39**
(optional)

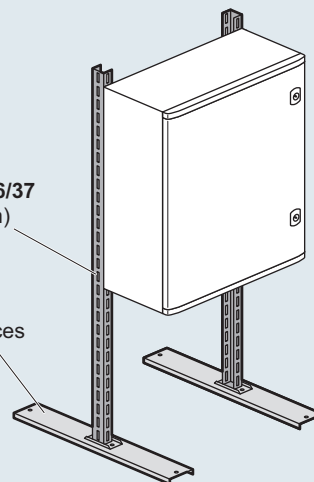

Stand Cat. No. 0364 37 is supplied with accessories to maintain IP 66 and Class II at the level of the passthrough fixing

■ Floor fixing on plinth

H 170 mm (polyester RAL 7035)

Roof RAL 7035
Cat. Nos. **0362 93/94/95**

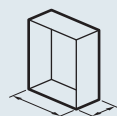

500 x 250 mm
600 x 300 mm
800 x 300 mm

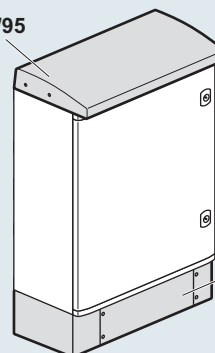

Plinth
Cat. No. **0362 91/92**

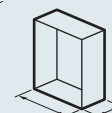

600 x 300 mm
800 x 300 mm

Marina free standing enclosures and equipment

polyester (GRP) - IP 66 - IK 10



Technical information and dimensions (p. 22)
Locking accessories (p. 28)
Ventilation and heating (p. 29-32)

Grey RAL 7035
 IP 66 according to IEC EN 60529
 IK 10 according to IEC EN 62262 (EN 50102)
 Class II insulation for final assembly according to IEC EN 60439-1
 Glass fibre reinforced polyester (GRP) enclosures
 Self extinguishing at 960 °C according to IEC EN 60695-2-11
 Designed for corrosive environments
 Stainless steel hinges and hinge pins
 Reversible door equipped with equipment mounting bosses
 Supplied with two part gland plate and fixing kit for plain plate or sectioned uprights
 Three point locking handle with European lock and 2433 A key⁽¹⁾
 Depth adjustment of equipment

Pack	Cat. Nos.	GRP enclosures				
		External dimensions (mm)			Weight (kg)	
		Height	Width	Depth		
1	0362 85	1460	800	463	49	
1	0362 86	1660	800	463	53	
1	0362 87	1860	800	463	57	

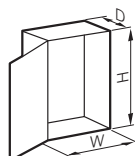

Pack	Cat. Nos.	Roof	
		Width	Depth
1	0362 97	800	463

Pack	Cat. Nos.	Plinth	
		For enclosures (mm)	
		Width	Depth
1	0362 96	800	463

Height 170 mm
 Front and rear access plates
 Stackable for extra height (2 max)

		Equipment		
		Plain plates		
		Galvanised steel. Premarked at 100 mm intervals		
		Permissible load : 200 kg/m ²		
		For enclosures (mm)		Net weight (kg)
		Height	Width	
1	0349 59	1460	800	27
1	0349 50	1660	800	30.5
1	0344 18	1860	800	34

Pack	Cat. Nos.	Sectioned uprights	
		For enclosures	
		Height (mm)	Length (mm)
1	0363 90	1460	1284
1	0363 91	1660	1484
1	0363 92	1860	1684

For Lina 25 rail, Lina rail and Lina 12.5 or Lina 25 plates
 Set of 2 uprights galvanised steel

Pack	Cat. Nos.	Lifting accessories	
1	0362 46	Lifting brackets M14 Set of 4 brackets for max. load 500 kg/m ³ Supplied with blanking plates	
1	0362 48	Assembly and lifting enclosures kit : - 2 support brackets - screws - weatherproof seal For 500 kg/m ³ lifting, order separately one set of 4 brackets Cat. No. 0362 46	

(1) Other barrels, see p. 28

Marina free standing enclosures and equipment

polyester (GRP) - IP 66 - IK 10

■ Dimensions and usable areas

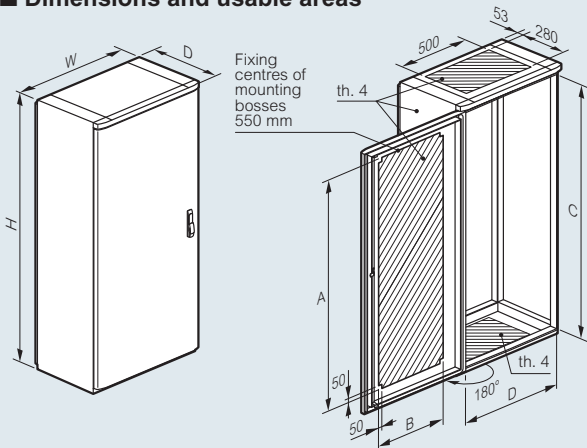

Cat. Nos.	Dimensions H x W x D (mm)	Usable area (mm)			
		A	B	C	D
0362 85	1460 x 800 x 463 ⁽¹⁾	1230	530	1300	700
0362 86	1660 x 800 x 463 ⁽¹⁾	1430	530	1500	700
0362 87	1860 x 800 x 463 ⁽¹⁾	1630	530	1700	700

(1) 487 mm when handle in use

■ Equipment fixing

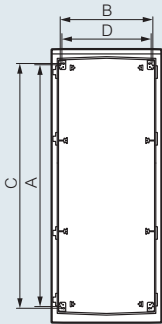

Cat. Nos.	Plain plate		Sectioned uprights ⁽¹⁾	
	A	B	C	D
0362 85	1225	675	1250	630
0362 86	1425	675	1450	630
0362 87	1625	675	1650	630

(1) For mounting partial plates

Sectioned uprights are required to fix partial plates in the 1660 and 1860 mm enclosures – order separately

■ Equipment adjustment

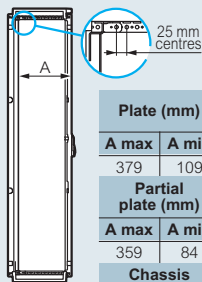
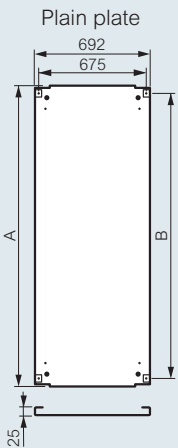

Plate (mm)	
A max	A min
379	109
Partial plate (mm)	
A max	A min
359	84
Chassis rail (mm)	
A max	A min
372	97

■ Mounting plates



Enclosure height	Plain	
	A	B
1460	1292	1225
1660	1492	1425
1860	1692	1625

■ Roof

Cat. No. 0362 97

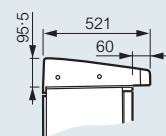

Weight : 2.5 kg
Width : 794 mm

■ Plinth

Cat. No. 0362 96

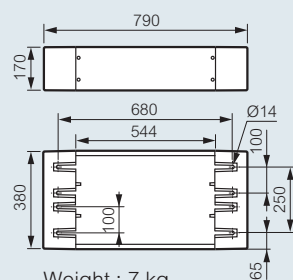

Weight : 7 kg

■ Sectioned uprights

Cat. Nos. 0363 90/91/92

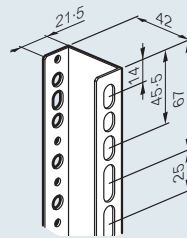

■ Suggested lifting method

4 x 500 kg slings and 4 brackets

A } 120° → 250 kg
90° → 300 kg
60° → 300 kg

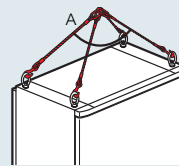

■ Assembly and lifting kit Cat. No. 0362 48 and lifting kit Cat. No. 0362 46

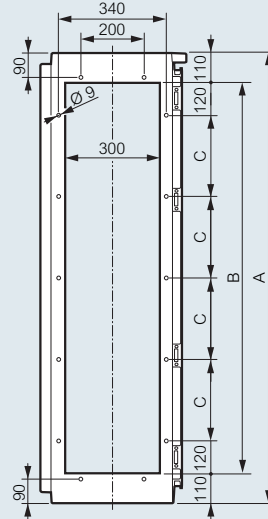

A } 120° → 500 kg
90° → 600 kg
60° → 600 kg

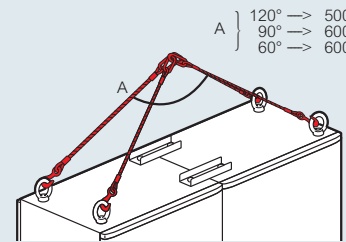

A } 90° → 800 kg
60° → 900 kg

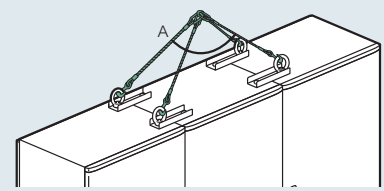

Cat. Nos.	Enclosure dimensions H x W x D (mm)	Dimensions (mm)		
		A	B	C
0362 85	1460 x 800 x 463	1460	1240	250
0362 86	1660 x 800 x 463	1660	1440	300
0362 87	1860 x 800 x 463	1860	1640	350

universal plates for wall mounting enclosures

Atlantic-E, Atlantic stainless steel and Marina



0360 55

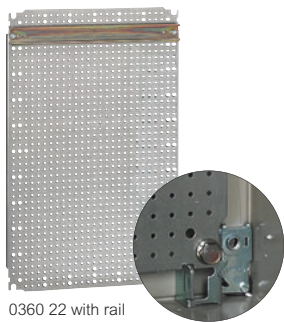

0360 22 with rail

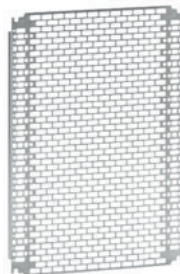

0360 18

[Technical information and dimensions \(p. 24\)](#)

Fixing accessories are supplied in each enclosure

Pack	Cat. Nos.	Plain plates	
		Not compatible with Atlantic-E enclosures	
		Pre-galvanised steel	
		2 mm thick up to 400 x 400	
		3 mm thick from 400 x 600	
		Vertical mounting for enclosures Height x Width (mm)	Weight (kg)
1	0360 50	300 x 200	1
1	0360 49 ⁽¹⁾	300 x 220	0.9
1	0360 52	300 x 400	1.3
1	0360 56	400 x 600	3.3
1	0360 55	500 x 400	2.7
1	0360 59	600 x 800	8.4
1	0360 58	700 x 500	6
1	0360 61	800 x 1000	14.4
1	0360 64	1200 x 800	18.5
1	0360 67 ⁽²⁾	1400 x 800	26.4
		Horizontal mounting for enclosures Height x Width (mm)	
		400 x 300	
		600 x 400	
		800 x 600	
		1000 x 800	

Pack	Cat. Nos.	Lina 25 perforated plates	
		Pre-galvanised steel	
		1.5 mm thick up to 600 x 400	
		2 mm thick from 600 x 600	
		Accepts clip nut fixings (see below)	
		For enclosure dimensions Height x Width (mm)	Weight (kg)
1	0360 07 ⁽³⁾	300 x 200	0.4
1	0360 99	300 x 220	0.5
1	0360 91	300 x 300	0.5
1	0360 12	400 x 300	0.6
1	0360 92	400 x 400	0.8
1	0360 15	500 x 400	0.9
1	0360 93	500 x 500	1.1
1	0360 16	600 x 400	1.3
1	0360 17	600 x 600	2.1
1	0360 18	700 x 500	2
1	0360 19	800 x 600	3.1
1	0360 20	800 x 800	4
1	0360 23	1000 x 600	3.7
1	0360 21	1000 x 800	4.9
1	0360 87	1200 x 800	7.1
1	0360 90	1400 x 800	7.8

Pack	Cat. Nos.	Lina 12.5 perforated plates	
		Pre-galvanised steel	
		2 mm thick	
		Ø 6.5 mm for rivets Cat. No. 0366 44	
		Ø 3.3 mm for equipment screws Cat. No. 0347 45 (see opposite)	
		Vertical mounting for enclosures Height x Width (mm)	Weight (kg)
1	0360 00 ⁽³⁾	300 x 200	0.4
1	0360 01 ⁽¹⁾	300 x 220	0.47
1	0360 02	300 x 300	0.6
1	0360 04	300 x 400	0.8
1	0360 05	400 x 400	1.1
1	0360 22	400 x 600	2.2
1	0360 09	500 x 400	1.5
1	0360 14	500 x 500	1.85
1	0360 24	600 x 600	3.7
1	0360 33	600 x 800	5.2
1	0360 40	600 x 1000	6.8
1	0360 31	700 x 500	3.7
1	0360 34	800 x 800	7
1	0360 42	800 x 1000	9.2
1	0360 46	1200 x 800	11.1
1	0360 75	1400 x 800	13
		Horizontal mounting for enclosures Height x Width (mm)	
		400 x 300	
		600 x 400	
		800 x 600	
		1000 x 600	
		1000 x 800	

Pack	Cat. Nos.	Fixing accessories	
		For Lina 12.5 perforated plates	
500	0366 44	Insulated plastic rivets Ø 6 mm for 6 mm holes	
100	0347 45	Self piercing tapping hex head screws 4.8 x 16 mm for Ø 3.3 mm holes	
200	0347 50	Plastic insulating cap for above	
		For Lina 25 perforated plates	
		Supplied without screws	
100	0364 40	Clip nuts for M4 screw	
100	0364 42	Clip nuts for M6 screw	

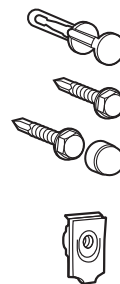

(1) For Marina enclosure only
 (2) For Atlantic stainless steel enclosures only
 (3) For Atlantic-E and Atlantic stainless steel enclosures

universal plates for wall mounting enclosures

Atlantic-E, Atlantic stainless steel and Marina

■ Mounting principle

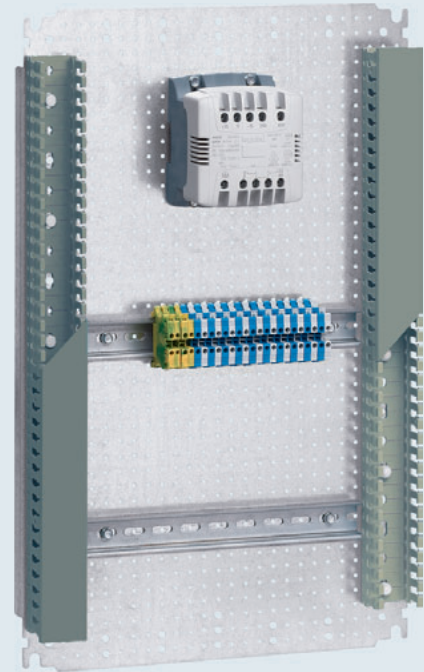
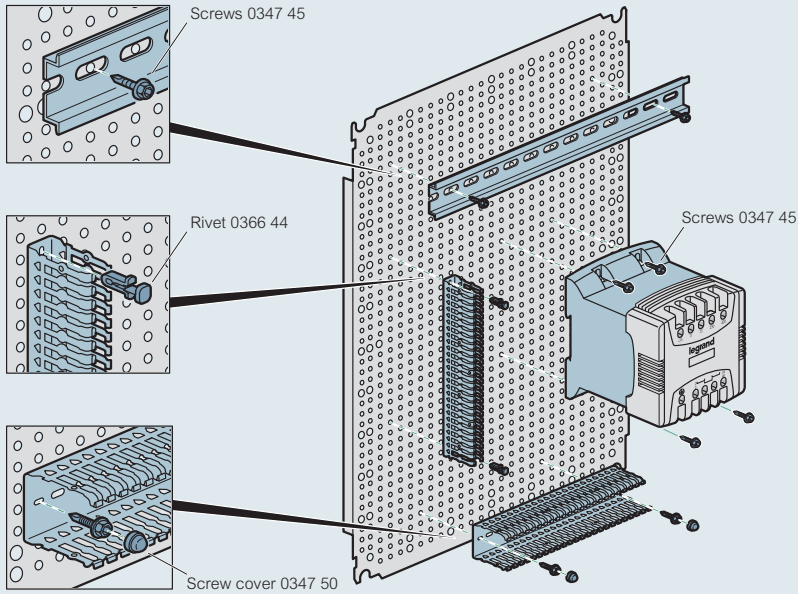

■ Dimensions

Plain plates, Lina 12-5 and Lina 25 perforated plates

Plain plate

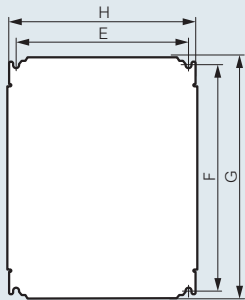

Lina 12-5 perforated plate

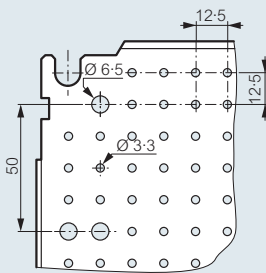

Lina 25 perforated plate

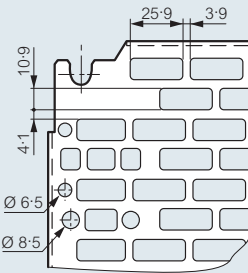

Fixing example on Lina 12-5 plate:

- of a transformer with screws Cat. No. 0347 45
- of a rail with Viking 3 terminals (p. 132)
- of Transcab panel trunking (p. 50)

Enclosure dimensions Height x Width (mm)	Dimensions of plates Plain / Lina 12-5 / 25 plates		Usable space for equipment (dm ²)	Mounting of plates	
	G (mm)	H (mm)		F (mm)	E (mm)
300 x 200	256	156	4.2	225	125
300 x 220	275	192	5.3	263	163
300 x 300	256	256	6.2	225	225
300 x 400 ⁽¹⁾	256	356	8.2	225	325
400 x 300 ⁽¹⁾	356	256	8.2	325	225
400 x 400	356	356	11.7	325	325
400 x 600 ⁽¹⁾	356	556	18.7	325	525
500 x 400	456	356	15.2	425	325
500 x 500	456	456	19.2	425	425
600 x 400 ⁽¹⁾	556	356	18.7	525	325
600 x 600	556	556	29.7	525	525
600 x 800 ⁽¹⁾	556	756	40.7	525	725
600 x 1000 ⁽¹⁾	556	956	51.7	525	925
700 x 500	656	456	28.7	625	425
800 x 600 ⁽¹⁾	756	556	40.7	725	525
800 x 800	756	756	55.7	725	725
800 x 1000 ⁽¹⁾	756	956	71.7	725	925
1000 x 600 ⁽¹⁾	956	556	51.7	925	525
1000 x 800 ⁽¹⁾	956	756	70.7	925	725
1000 x 1000	956	956	89.7	925	925
1000 x 1200 ⁽¹⁾	956	1156	108.7	925	1125
1200 x 800	1156	756	85.7	1125	725
1200 x 1000 ⁽¹⁾	1156	956	108.7	1125	925
1200 x 1200	1156	1156	131.7	1125	1125
1400 x 800	1356	756	100.7	1325	725
1400 x 1000	1356	956	127.7	1325	925

(1) For horizontal or vertical mounting

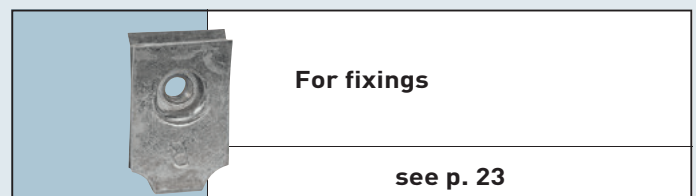

chassis and internal doors for wall mounting enclosures

Atlantic-E, Atlantic stainless steel and Marina



0361 03



0361 03 mounted in enclosure





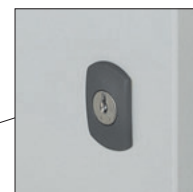

0363 60 internal door with Atlantic steel enclosure 0355 03 + kit 0363 69



Accept key barrel

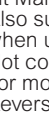
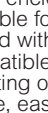
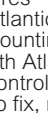

Technical information and dimensions (p. 27)

Pack	Cat. Nos.	Insulated modular chassis
1	0361 01	<p>Grey RAL 7035 Separate ABS front plate per row Supplied in kit form with metal uprights and crosspieces Symmetrical rails  depth 15 mm Fixings supplied with enclosure Self extinguishing 750 °C</p> <p>For enclosure dimensions Height x Width x Depth (mm)</p> <p>400 x 300 x 200 30 modules (3 rows of 10) Supplied with 1 blanking plate</p> 
1	0361 02	<p>500 x 400 x 200 48 modules (3 rows of 16) Supplied with 1 blanking plate</p> 
1	0361 03	<p>600 x 400 x 250 48 modules (3 rows of 16) Supplied with 1 blanking plate</p> 
1	0361 05	<p>700 x 500 x 250 84 modules (4 rows of 21) Supplied with 1 blanking plate</p> 
1	0361 06	<p>800 x 600 x 300 108 modules (4 rows of 27) Supplied with 2 blanking plates</p> 
1	0361 09	<p>1 000 x 800 x 300 190 modules (5 rows of 38) Supplied with 2 blanking plates</p> 
1	0361 10	<p>1 200 x 800 x 300 228 modules (6 rows of 38) Supplied with 2 blanking plates</p> 

Pack	Cat. Nos.	Blanking plate for windows
10	0361 00	<p>For enclosures up to 800 mm wide Blanking plate to suit up to 670 x 45 mm window To be cut to required length 38 modules, length 684 mm</p>

Pack	Cat. Nos.	Internal doors																								
1	0363 59	<p>Grey RAL 7035 - IP xxB Fit Marina enclosures Also suitable for Atlantic stainless steel enclosures when used with mounting kit Cat. No. 0363 69 Not compatible with Atlantic-E enclosures For mounting of control and signalling units Reversible, easy to fix, robust 4 mm thick GRP construction Left or right opening with built in grip Captive hinge pins Double bar lock : 1 lock for height 400 to 600 mm 2 locks for height ≥ 700 mm</p>																								
1	0363 60	<table border="1"> <thead> <tr> <th>For enclosures (mm) H x W</th> <th>Dim. (mm) H x W</th> <th>Usable area (mm) H x W</th> </tr> </thead> <tbody> <tr> <td>400 x 300</td> <td>341 x 236</td> <td>305 x 185</td> </tr> <tr> <td>500 x 400</td> <td>441 x 336</td> <td>405 x 250</td> </tr> <tr> <td>600 x 400</td> <td>541 x 336</td> <td>505 x 250</td> </tr> <tr> <td>700 x 500</td> <td>642 x 436</td> <td>500 x 340</td> </tr> <tr> <td>800 x 600</td> <td>742 x 536</td> <td>600 x 440</td> </tr> <tr> <td>1 000 x 800</td> <td>942 x 736</td> <td>800 x 640</td> </tr> <tr> <td>1 200 x 800</td> <td>942 x 736</td> <td>800 x 640</td> </tr> </tbody> </table>	For enclosures (mm) H x W	Dim. (mm) H x W	Usable area (mm) H x W	400 x 300	341 x 236	305 x 185	500 x 400	441 x 336	405 x 250	600 x 400	541 x 336	505 x 250	700 x 500	642 x 436	500 x 340	800 x 600	742 x 536	600 x 440	1 000 x 800	942 x 736	800 x 640	1 200 x 800	942 x 736	800 x 640
For enclosures (mm) H x W	Dim. (mm) H x W	Usable area (mm) H x W																								
400 x 300	341 x 236	305 x 185																								
500 x 400	441 x 336	405 x 250																								
600 x 400	541 x 336	505 x 250																								
700 x 500	642 x 436	500 x 340																								
800 x 600	742 x 536	600 x 440																								
1 000 x 800	942 x 736	800 x 640																								
1 200 x 800	942 x 736	800 x 640																								
1	0363 61																									
1	0363 62																									
1	0363 63																									
1	0363 64																									
1	0363 65 ⁽¹⁾																									

Pack	Cat. Nos.	Accessory
1	0363 69	Mounting kit for Atlantic stainless steel enclosures

(1) Door identical to Cat. No. 0363 64 with 200 mm upper or lower reservation

equipment and fixing accessories for wall mounting enclosures

Atlantic-E, Atlantic stainless steel and Marina



Uprights + crosspieces (subject to size)
Pocket Cat. No. 0365 80

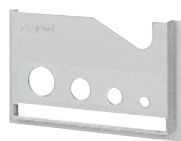

0365 81



0367 80



0364 40



0347 45



0366 44



0347 50

Technical information and dimensions (p. 27)

Pack **Cat. Nos.** **Lina 25 sectioned uprights**

Pack	Cat. Nos.	Set of 2 sectioned uprights			Profile
		For enclosures height (mm)	Length of uprights (mm)	Thickness (mm)	
5	0361 50	300	237	2.5	
5	0361 51	400	337	2.5	
5	0361 52	500	437	2.5	
5	0361 53	600	537	2.5	
5	0361 54	700	637	2.5	
5	0361 55	800	737	2.5	
5	0361 56	1000	937	2.5	
5	0361 58	1200	1 137	2.5	
5	0361 59	1400	1 337	2.5	

Lina 25 crosspieces
Crosspieces ready to assemble (excluding fixings)
For dimensions, see p. 27

Pack	Cat. Nos.	For enclosures width (mm)	
		For enclosures width (mm)	Crosspiece length (mm)
10	0367 80	300	243
10	0367 81	400	343
10	0367 82	500	443
10	0367 83	600	543
10	0367 84	800	743

Rails
2 m length
For dimensions, see p. 27

10	0374 02	EN 60715
10	0374 07	Symmetrical, depth 15 mm

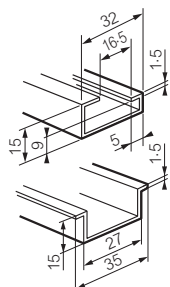

45° mounting bracket

10	0394 49	Set of 2 supports for tilting a rail at an angle of 45° Supplied with 4 x M6 screws, nuts and washers	
----	---------	--	--

Self-adhesive document pockets
RAL 7035

Pack	Cat. Nos.	External dimensions (mm)		Internal dimensions (mm)	
		Width	Height	Width	Height x Depth
20	0365 80	340	235	310	200 x 18
20	0365 81	260	165	230	130 x 18

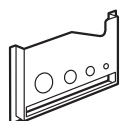

Pack **Cat. Nos.** **Fixing accessories**

100	0364 40	For Lina 25 perforated plates	
100	0364 42	Supplied without screws Clip nuts for M4 screw Clip nuts for M6 screw	
500	0366 44	For Lina 12.5 perforated plates	
100	0347 45	Insulated plastic rivets Ø 6 mm for 6 mm holes Self piercing tapping hex head screws 4.8 x 16 mm for Ø 3.3 mm holes	
200	0347 50	Plastic insulating cap for above	
100	0364 78	For rails EN 60715 ,	
10	0044 16	For rail EN 60715	
10	0044 17	Claw width 10 mm Threaded hole For M4 screw	
10	0044 17	Claw width 17.5 mm Smooth hole Ø 3.8 mm Supplied with fixing screw Ø 3.5 mm Length 13 mm	
40	0364 69	Fixomega for M4 screw	

Lina perforated plates (see p. 23)

equipment and fixing accessories for wall mounting enclosures

Atlantic-E, Atlantic stainless steel and Marina

■ Assembled chassis with crosspieces and Lina 25 uprights

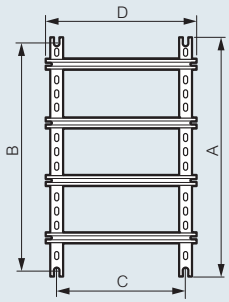

Enclosure dimensions Height x Width (mm)	Crosspiece length		Chassis fixing	
	A (mm)	D (mm)	B (mm)	C (mm)
300 x 300	237	243	225	225
300 x 400	237	343	225	325
400 x 300	337	243	325	225
400 x 400	337	343	325	325
400 x 600	337	543	325	525
500 x 400	437	343	425	325
500 x 500	437	443	425	425
600 x 400	537	343	525	325
600 x 600	537	543	525	525
700 x 500	637	443	625	425
800 x 600	737	543	725	525
800 x 800	737	743	725	725
1000 x 600	937	543	925	525
1000 x 800	937	743	925	725
1200 x 800	1137	743	1125	725

■ Lina 25 sectioned uprights

Cat. Nos. 0361 50/51/52/53/54/55/56

Cat. No. 0361 58

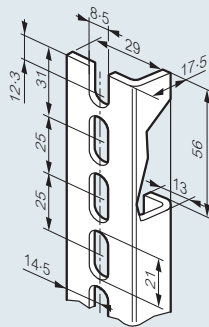
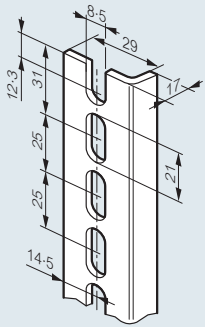

■ Crosspieces/rails

Cat. Nos. 0367 80/81/82/83/84

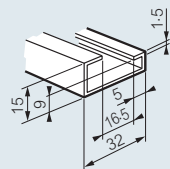
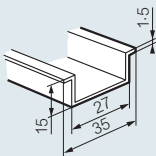

See p. 26 for crosspieces/rails

■ Clip nuts



See p. 26 for clip nuts

■ Insulated modular chassis

Fixes to corner fixings inside enclosure
Chassis can fit steel or polyster enclosures



0361 03 fitted into enclosure

Space between door and chassis front

- Atlantic stainless steel } Depth 250 : 80 mm
- Marina } Depth 300 : 90 mm



The front sections can only be removed using a tool (flat blade screwdriver)

Glow wire tested : 5s at 750 °C

locking accessories

for Atlantic stainless steel and Marina enclosures

Pack Cat. Nos. Lock housings for rebate or cylinder locks

10	0368 04	Interchangeable for Atlantic stainless steel and Marina enclosures Plastic housing (excludes barrel and cam)	
10	0368 05	Handle With blank (excludes cam)	
10	0368 06	Handle Fitted with locking barrel 2433 A (excludes cam)	

Locking cams

10	0365 30	For Marina enclosures	
10	0368 43	For Atlantic stainless steel 1 door enclosures	
10	0368 44	For Atlantic stainless steel 2 door enclosures	

Note : Cam nuts are supplied with the handle or housing

Metal rebate lock barrels

10	0368 17	6.5 mm male triangle	
10	0368 18	8 mm male triangle	
10	0368 19	11 mm male triangle	
10	0368 20	Double bar	

Key barrels

		Supplied with set of 2 keys For key No :	
10	0368 22	405	
10	0368 23	421	
10	0368 24	455	
10	0368 25	1242 E	
10	0368 26	2433 A	
10	0368 27	3113 A	
10	0365 45	Set of two 2433 A keys	

Keys for rebate locks

10	0365 39	For 6.5 mm male triangle lock	
10	0365 40	For 8 mm male triangle lock	
10	0365 41	For 11 mm male triangle lock	
10	0365 42	Double bar	

Padlocking

1	0365 11	Padlock adaptor Metal painted black-grey RAL 7021 Fits over door handles to provide security Accepts up to 3 padlocks	
---	---------	---	---

locking accessories

for Atlantic stainless steel and Marina enclosures

Universal locking system⁽¹⁾

The locks can be assembled and fitted to all Atlantic stainless steel and Marina enclosures

Lock barrels

6.5 mm triangle male
Cat. No. 0368 17

8 mm male triangle
Cat. No. 0368 18

11 mm male triangle
Cat. No. 0368 19

Double bar
Cat. No. 0368 20

Detail of cut-out

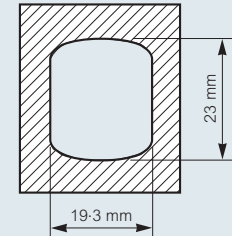

Key barrels

No. 405
Cat. No. 0368 22

No. 421
Cat. No. 0368 23

No. 455
Cat. No. 0368 24

1242 E
Cat. No. 0368 25

2433 A
Cat. No. 0368 26

3113 A
Cat. No. 0368 27



Dimensions of special triangle locks

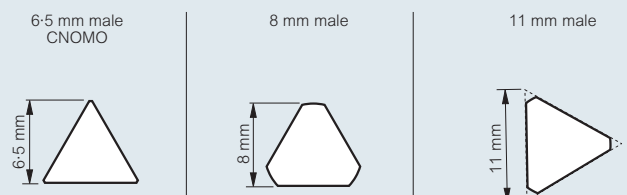

(1) The metal locks (special barrels and key barrels) and lock barrels are all compatible with each other

ventilation for enclosures



0348 17



0365 79



0348 04



0348 52



0348 89



0348 05



0348 35



Technical information and dimensions (p. 30, 32)

Pack	Cat. Nos.	Ventilation fan kit with metal grill
1	0348 17	<p>IP 32 - IK 10 230 V - 50/60 Hz RAL 7035 Ventilator is mounted on the outside of the enclosure 30 m³/h with filter - 160 m³/h without filter installed (free flowing) Pack comprising a pair of metal RAL 7035 louvres and a pair of anti-insect grills, plus internal finger protection</p>

Pack	Cat. Nos.	Ventilation fan kits with plastic grill
1	0348 50	<p>IP 54 - IK 08 230 V - 50/60 Hz RAL 7035 plastic housing Supplied with finger protection guards External projection 7-10 mm Accepts mounting spacer Cat. No. 0348 88/89 Used to reduce internal projection and improve wiring space Fitted externally on to the enclosure with rapid fix screws 1 mm to 4 mm panel thickness An extra louvre can be fitted to improve air flow and extraction</p> <p>40/160 m³/h 40 m³ with filter 160 m³ with extra grill/filter Cat. No. 0348 34 160 m³ without filter installed (free flowing) Pack comprising a pair of RAL 7035 plastic grills 150 x 150 mm and washable electrostatic filter EU3, G3</p>
1	0348 51	<p>120/160 m³/h 120 m³ with filter 130 m³ with extra grill/filter Cat. No. 0348 35 160 m³ without filter installed (free flowing) Pack comprising a pair of RAL 7035 plastic grills 250 x 250 mm and washable filter EU3, G3</p>
1	0348 52	<p>240/450 m³/h 240 m³ with filter 260 m³ with extra grill/filter Cat. No. 0348 35 450 m³ without filter installed (free flowing) Pack comprising a pair of RAL 7035 plastic grills 250 x 250 mm and washable filter EU3, G3</p>

Pack	Cat. Nos.	Spacers for ventilation fan kits
1	0348 88	IP 54 maintained RAL 7035 Used to reduce the internal projection and increase the internal usable volume 150 x 150 mm
1	0348 89	250 x 250 mm

Pack	Cat. Nos.	Natural ventilation
2	0365 78	Ventilation glands IP 44 - IK 08 for outdoor use Grey polyamide Ø 15 mm aperture needed
2	0365 79	Ø 30.5 mm aperture needed
1	0348 04	Ventilation louvres - metal IP 32 - IK 10 RAL 7035 Pack comprising a pair of metal louvres and a pair of anti-insect grills 138 x 138 mm
1	0348 05	248 x 248 mm
1	0348 34	Ventilation louvres - plastic RAL 7035 Supplied singly Supplied with 10 mm thick filter EU 3, G3 IP 44 - 150 x 150 mm
1	0348 35	Supplied with 20 mm thick filter EU 3, G3 IP 54 - 250 x 250 mm
1	0348 36	IP 54 - 325 x 325 mm

■ Operating principle

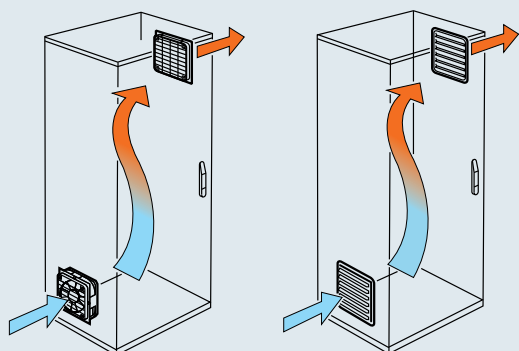

Ventilators,
louvres and
spacers

Natural
ventilation

■ Ventilation fan kits, louvres and spacers

Dimensions and cut-outs

Cat. No. 0348 17

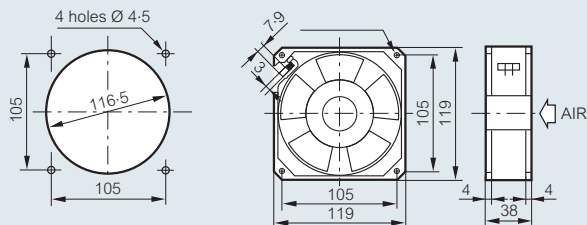

Cat. Nos. 0348 50/51/52/34/35/36

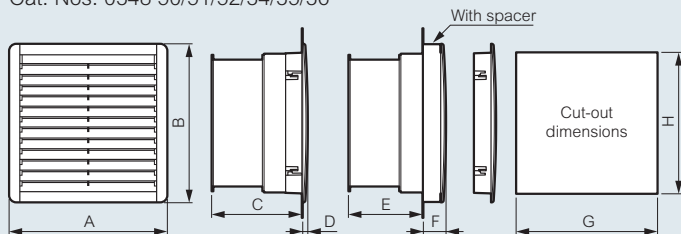

Cat. Nos.	A (mm)	B (mm)	C (mm)	D (mm)	E (mm)	F (mm)	G (mm)	H (mm)
0348 50	150	150	70	7	43	34	125	125
0348 51	250	250	105	8	78	35	223	223
0348 52	250	250	123	8	96	35	223	223
0348 34	150	150	-	7	-	34	125	125
0348 35	250	250	-	8	-	35	223	223
0348 36	325	325	-	10	-	37	291	291

Technical characteristics

Cat. Nos.	0348 17	0348 50	0348 51	0348 52
Voltage (V)/phase	220-240/1	230/1	230/1	220-240/1
Frequency (Hz)	50/60	50/60	50/60	50/60
No load flow ventilation only (m ³ /h)	160	160	160	240
On load flow - with an output louvre (supplied)	30	40	100	170
Static pressure (mm of water)	100	66	51	111
Power down (W)	22	20	20	29
Current down (A)	0.14	0.125	0.125	0.426
Operating temperature	-10°C/+50°C			
IP/IK	32/10	54/08	54/08	54/08
Sound level (dB)	49	43	43	50
Weight (kg)	0.72	0.8	1.4	1.7

■ Natural ventilation Dimensions and cut-outs

Cat. No. 0348 04

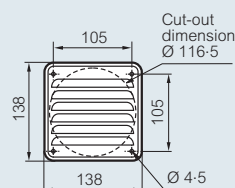

Cat. No. 0348 05

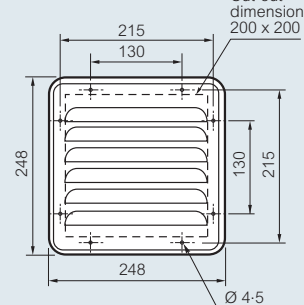

Cat. No. 0365 78

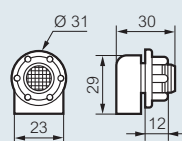

Cat. No. 0365 79

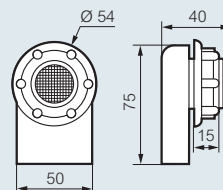

heating for enclosures



0353 08



0348 47



Technical information and dimensions (opposite)

Pack	Cat. Nos.	Heating	
		Resistance heaters 120 V / 240 V ~	
		IP 20 Prevent condensation forming inside the enclosure " PTC " auto-regulated and surface temperature limited : $t = 70^{\circ}\text{C}$ Heat dissipator in black aluminium oxide Fix on rail	
		Power	Current rating
1	0353 06	20 W	2.5 A
1	0353 07	50 W	2.5 A
1	0353 08	100 W	4.5 A
1	0353 09	150 W	8.0 A
		Thermostat	
		Precision 0.5 °C (neutral connected) Switching and control range : 2 °C 230 V - 50/60 Hz 12 to 250 V~ (requires neutral) Contact rating : 10 A max. (5 A closing) NO contact : 10 A, 250 V~ NC contact : 5 A, 250 V~ Adjustable from 5 to 60 °C with NO/NC contact	
1	0348 47	Fix on rail	

heating for enclosures

■ Operating principle

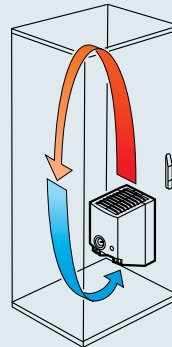

Heating

■ Dimensions

Resistance heaters

Cat. Nos. 0353 06/07/08/09

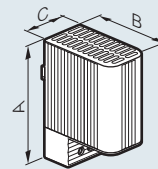

Cat. Nos.	Power	A	B	C
0353 06	20 W	98	75	38
0353 07	50 W	110	90	60
0353 08	100 W	110	90	60
0353 09	150 W	150	90	60

Vertical installation at the bottom of the enclosure

Air circulation :

- ensure clearance >50 mm all round the device
- do not cover

Resistance heaters

Cat. No. 0348 47

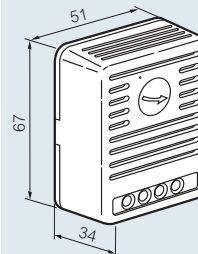

Vertical installation at the bottom of the enclosure

Recommended clearance around heat regulation products for optimal air circulation :

- ensure clearance >50 mm all round the device
- do not cover

■ Wiring diagram

Cat. Nos. 0353 07/08/09

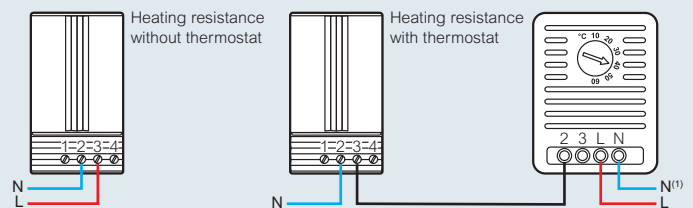

Cat. No. 0353 06

Thermostat Cat. No. 0348 47

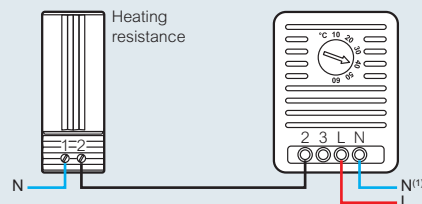

(1) Connection accelerating resistance

ventilation and heating for enclosures

■ Technical information

Three factors should be considered :

- The surface area of the enclosure : S_c (m²)
- The maximum permissible temperature : Δt (°C)
- The power dissipation of the equipment : P(W)

Operating procedure :

1. Determine the surface area (S_c) of the enclosure using the charts below
The values indicated take into account the shape of the enclosure

Atlantic enclosures

Dimensions (mm) Height x Width x Depth	S_c (m ²)
300 x 200 x 160	0-15
300 x 300 x 200	0-28
300 x 400 x 200	0-28
400 x 300 x 200	0-25
400 x 400 x 200	0-32
500 x 400 x 200	0-35
600 x 400 x 200	0-36
400 x 600 x 250	0-46
500 x 400 x 250	0-41
500 x 500 x 250	0-47
600 x 400 x 250	0-46
600 x 600 x 250	0-61
700 x 500 x 250	0-56
800 x 600 x 250	0-71
800 x 800 x 250	0-87
800 x 1000 x 250	0-97
1000 x 600 x 250	0-77
1000 x 800 x 250	0-96

Dimensions (mm) Height x Width x Depth	S_c (m ²)
600 x 600 x 300	0-76
700 x 500 x 300	0-79
800 x 600 x 300	0-78
800 x 800 x 300	0-95
800 x 1000 x 300	1-08
1000 x 600 x 300	0-86
1000 x 800 x 300	1-05
1000 x 1000 x 300	1-16
1200 x 800 x 300	1-15
1200 x 1000 x 300	1-36
1200 x 1200 x 300	1-55
1400 x 1000 x 300	1-41
600 x 600 x 400	0-79
800 x 600 x 400	1-07
1000 x 800 x 400	1-55
1200 x 800 x 400	1-33
1200 x 1200 x 400	1-75
1400 x 800 x 400	1-72

Marina enclosures

Dimensions (mm) Height x Width x Depth	S_c (m ²)
300 x 220 x 160	0-14
405 x 305 x 200	0-31
505 x 405 x 200	0-36
605 x 405 x 250	0-41
728 x 518 x 250	0-52
828 x 618 x 300	0-72
1028 x 818 x 300	0-96
1508 x 908 x 400	1-50
1800 x 800 x 400	1-10

2. Calculation : Once you know the S_c of your enclosure and the admissible temperature Δt (°C), determine the maximum power dissipation of the unequipped enclosure. If the result is less than the heat dissipation required then a cooling system must be installed

Note :

Heat exchangers and air conditioners are available to special order, details are available on request
Contact us on +44 (0) 845 605 4333

3. Consult the relevant curve to check that heat dissipation is at least equal to the heat dissipation value corresponding to maximum permissible heat-up

■ Ventilation

The curves below enable the user to determine whether the enclosure must have a ventilation system, based on 3 parameters :

- Δt °C between t° ambient and t° maximum to be obtained at the hottest point
- power dissipated in watts [P(W)]
- effective surface area of enclosure S_c

Natural dissipation for an unequipped enclosure

S_c up to 3 m²

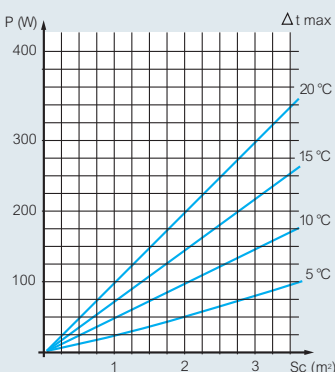

S_c above 3 m²

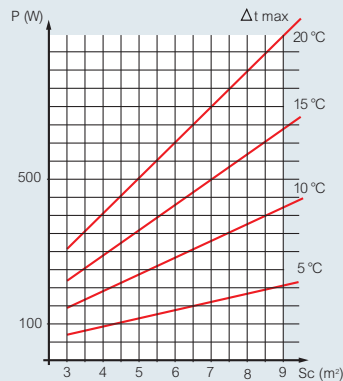

■ Heating

Determine the overall power absorbed by heating elements to be installed according to the effective surface area - S_c - of the enclosure and the desired increase Δt

S_c up to 1 m²

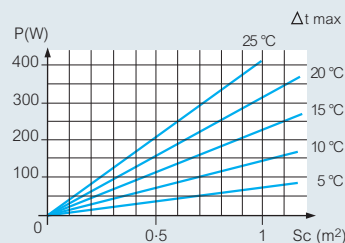

S_c above 1 m²

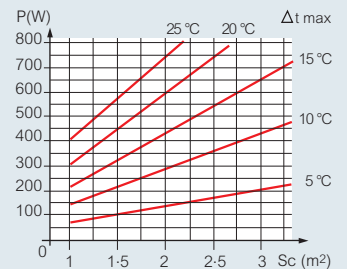

Plexo³ weatherproof enclosures and accessories

IP 65 - IK 09

NEW



6019 74



6019 82



0019 66



0019 55



Technical information and dimensions (p. 34)

IP 65 - IK 09 - Class II
 Self-extinguishing : resistance to incandescent wire 650 °C
 Conform to EN 60439-3
 Door and enclosure fully reversible
 Removable chassis and faceplates from 2 row versions up
 2 position rail for modular products and moulded cases
 Spacing between rails 150 mm
 Can be fitted with perforated plates and solid faceplates for mounting non-modular products
 Lockable door handle, sealable cover and faceplate
 Shock-resistant polystyrene material
 Box colour light grey L750A, cover colour dark grey R746A
 Supplied without terminal blocks

Pack	Cat. Nos.	Enclosures 2 to 8 modules	
		Number of rows	Number of modules
1	6019 32	1	2 (+1)
1	6019 74	1	4
1	6019 76	1	6
1	6019 78	1	8

Pack	Cat. Nos.	Enclosures 12 modules per row	
		Number of rows	Number of modules
1	6019 81	1	12
1	6019 82	2	24
1	6019 83	3	36

Pack	Cat. Nos.	Enclosures 18 modules per row	
		Number of rows	Number of modules
1	6019 85	1	18
1	6019 86	2	36
1	6019 87	3	54
1	6019 88	4	72

Pack	Cat. Nos.	Accessories	
1	0019 66	Key lock	N° 850
1	0019 68	Sealing kit	Set of 2 sealable terminal shields for cover and 8 sealable supports for faceplate
1	0019 69	Wall mounting brackets	Set of 4
20	0019 61	Blanking plates	5, separable into modules or 1/2 module Grey R746A
1	0019 55	Direct piercing end caps	Pack consisting of 2 Ø32 mm ISO end caps, 5 Ø25 mm ISO end caps and 10 Ø20 mm ISO end caps
2	0019 64	Plain faceplates	For 12 modules enclosures
2	0019 65		For 18 modules enclosures
1	0019 62	Perforated plates	Allow the DIN rail to be replaced with a Lina 25 plate when integrating non-modular products For 12 modules enclosures Height 150 mm
1	4018 53		For 18 modules enclosures Height 150 mm
25	0980 03	ISO M20 cable gland	Cable gland IP68



■ Dimensions

Enclosures 2, 4, 6 and 8 modules

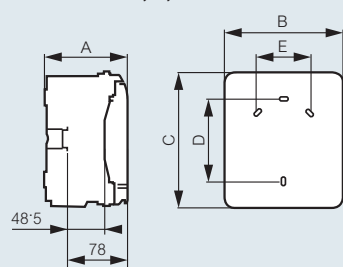

Cat. Nos.	Dimensions (mm)				
	A	B	C	D	E
6019 32	109	93	174	94	-
6019 74	115.6	128	200	120	-
6019 76	115.6	164	200	120	70
6019 78	115.6	200	200	120	106

Enclosures 12 and 18 modules

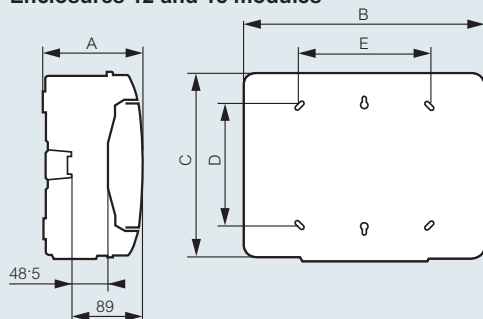

Cat. Nos.	Dimensions (mm)				
	A	B	C	D	E
6019 81	141	340	282	180	180
6019 82	161	340	432	330	180
6019 83	161	340	622	480	180
6019 85	141	448	282	180	288
6019 86	161	448	432	330	290
6019 87	161	448	622	480	290
6019 88	161	448	822	680	290

■ Fixing centres

Fixing the enclosure on the wall

Each enclosure is equipped with knockout entries for 2 wall fixing methods :

Hanging fixing

1 point in the middle, 2 points at the bottom

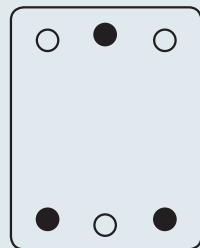

Adjustable peripheral fixing

4 fixing points

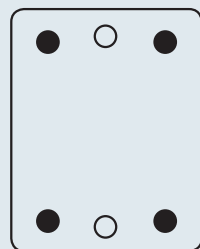

■ Number of knockouts on each side

Cat. Nos.	Top/bottom			Left/right		
	Ø20 mm	Ø25 mm	Ø32 mm	Ø20 mm	Ø25 mm	Ø32 mm
6019 32	2	-	-	-	-	-
6019 74	2	1	-	2	-	-
6019 76	4	1	-	2	-	-
6019 78	6	1	-	2	-	-
6019 81	7	2	2	-	-	2
6019 82	13	2	2	-	-	3
6019 83	13	2	2	-	-	4
6019 85	12	2	3	-	-	2
6019 86	13	4	3	-	-	3
6019 87	13	4	3	-	-	4
6019 88	13	4	3	-	-	5

■ Old/new range cross reference table

Old Plexo Cat. Nos.	New Plexo ³ Cat. Nos.	Number of rows	Total number of modules
Enclosures 2 to 8 modules			
0017 02	6019 32	1	2 (+1)
0017 04	6019 74	1	4
0017 06	6019 76	1	6
0017 08	6019 78	1	8
Enclosures 12 modules per row			
0017 11	6019 81	1	12
0017 12	6019 82	2	24
0017 13	6019 83	3	36
Enclosures 18 modules per row			
-	6019 85	1	18
-	6019 86	2	36
-	6019 87	3	54
-	6019 88	4	72

■ Direct piercing end caps

Cat. No.	Type	Number of end caps per pack	Ø	
			Min. (mm)	Max. (mm)
0019 55	ISO 20	10	4	13
	ISO 25	5	9	18
	ISO 32	2	12	25

terminal shield boxes

with rail



Pack	Cat. Nos.	Terminal shield boxes
		Distribution boxes - 1 to 9 modules
		IP 30 - IK 05
		Conform to IEC 60439-3
		White RAL 9010
		Self-extinguishing
		Supplied with terminal block (box for 6 modules or more)
		Covers can be sealed and clipped on directly (except for box for 9 modules)
		Capacity in 17.5 mm modules
		Dimensions (mm) Height x Width x Depth
10	0013 01	1 140 x 30 x 72
10	0013 02	2 140 x 50 x 72
10	0013 04	4 160 x 90 x 74
5	0013 06	6 160 x 128 x 74
1	0013 08	(8 + 1) 180 x 190 x 83
10	0013 98	Membrane gland for boxes Cat. Nos. 0013 01 to 08

terminal shield boxes

with rail

■ Dimensions

Cat. Nos. 0013 01/02/04/06/08

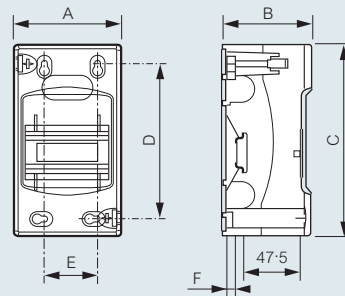

Cat. Nos.	A (mm)	B (mm)	C (mm)	D (mm)	E (mm)	F (mm)
0013 01	30	72	140	120	10	7
0013 02	50	72	140	115	25	7
0013 04	90	74	160	130	45	7
0013 06	128	74	160	125	80	7
0013 08	190	83	180	130	120	14.5

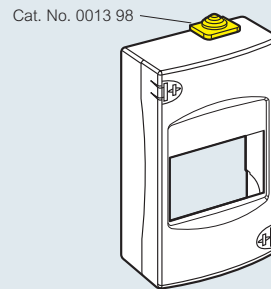

Entry via tube or cable

Plexo weatherproof boxes

selection chart

DIMENSIONS	CABLE ENTRY	INDUSTRIAL BOXES				ACCESSORIES		
 Internal dimensions (mm) Height x Width x Depth	Cable entry type	With IP 55 plain clip-on covers	With IP 55 covers		With IP 55 plain hinged covers - 2 x 1/4 turn fixings	With IP 66 plain covers	Mounting plates	Hinge kit accessories
			Plain	Transparent				
Ø 60 x 40	membrane	0921 00	-	-	-	-	-	-
Ø 70 x 45	membrane	0921 01	-	-	-	-	-	-
65 x 65 x 40	membrane	0921 04	-	-	-	-	-	-
80 x 80 x 45	none	0921 28	-	-	-	-	-	-
80 x 80 x 45	membrane	0921 26	-	-	-	-	-	-
80 x 80 x 45	knockout	0921 27	-	-	-	-	-	-
105 x 105 x 55	membrane	-	0921 36	-	-	-	-	-
105 x 105 x 55	none	-	0921 38	-	-	-	-	-
105 x 105 x 55	knockout	-	0921 37	-	-	-	-	-
130 x 75 x 74	none	-	0359 00	-	-	0350 07	-	-
130 x 130 x 74	membrane	-	0920 32	-	-	-	0358 10	-
130 x 130 x 74	none	-	0359 30	-	-	0350 13	0358 10	0358 00
155 x 110 x 74	membrane	-	0920 42	-	-	-	0358 11	-
155 x 110 x 74	none	-	0359 40	-	-	0350 17	0358 11	0358 00
180 x 140 x 86	none	-	0359 50	0359 51	-	0350 22	0358 12	0358 00
220 x 170 x 86	none	-	0359 60	0359 61	-	0350 28	0358 13	0358 00
220 x 170 x 140	none	-	-	-	0921 22	-	0350 90	-
265 x 174 x 154	none	-	-	-	0350 43	-	0350 92	-
270 x 170 x 86	none	-	0359 70	0359 71	-	0350 33	0358 14	0358 00
310 x 240 x 124	none	-	0359 80	-	-	0350 44	0358 15	0358 01
310 x 240 x 160	none	-	-	-	0922 84	-	0350 93	-
359 x 265 x 154	none	-	-	-	0350 58	-	0350 94	-
360 x 270 x 124	none	-	0359 90	-	-	0350 47	0358 16	0358 01

Plexo weatherproof boxes

IP 55 - IK 07



0921 01



0921 26



0921 36



Dimensions (opposite)

IP 55 - IK 07
 Grey RAL 7035
 Conform to EN 60695-2-1
 Polystyrene box and polypropylene cover - halogen free
 Temperature rating : -25 °C to +40 °C
 Self-extinguishing 650 °C
 Membrane glands
 Plain cover

Pack	Cat. Nos.	Weatherproof boxes – round
5	0921 00	With fixing slots for easy alignment Use 5 mm Ø screws Clip-on cover Nominal internal dimensions : Ø x Depth Ø 60 mm x 40 mm 4 glands
5	0921 01	Ø 70 mm x 45 mm 4 glands

Pack	Cat. Nos.	Weatherproof boxes – square
5	0921 04	With fixing slots for easy alignment Use 5 mm Ø screws Clip-on cover Nominal internal dimensions : Height x Width x Depth 65 x 65 x 40 mm 7 glands
5	0921 26	80 x 80 x 45 mm 7 glands
5	0921 27	80 x 80 x 45 mm With pre-cut knockouts

Pack	Cat. Nos.	Weatherproof boxes – square class II
5	0921 36	Mounting by : • either internal fixing points - use 5 mm Ø screws • or at three corners outside the wiring area Use 4 mm Ø screws Provision for anti-tamper seal Cover with 4 x 1/4 turn fixings, indicated I-O, can be retained open during installation Nominal internal dimensions : Height x Width x Depth 105 x 105 x 55 mm 7 glands
5	0921 37	105 x 105 x 55 mm With pre-cut knockouts

Plexo weatherproof boxes

IP 55 - IK 07

■ Dimensions (mm)

Cat. Nos. 0921 00 and 0921 01

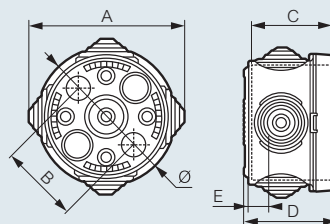

Cat. Nos.	Ø (mm)	A (mm)	B (mm)	C (mm)	D (mm)	E (mm)
0921 00	60	79	40	44.5	40	11
0921 01	70	86	50	49.5	45	11

Cat. No. 0921 04

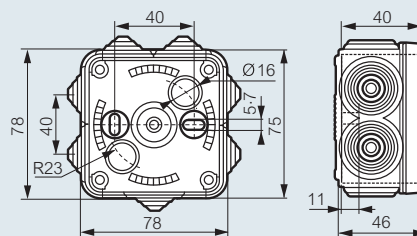

Cat. No. 0921 26

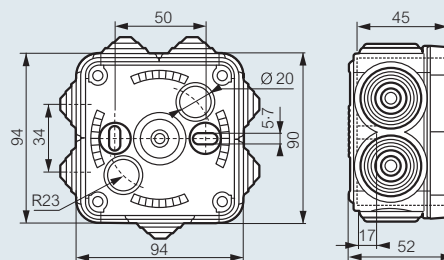

Cat. No. 0921 36

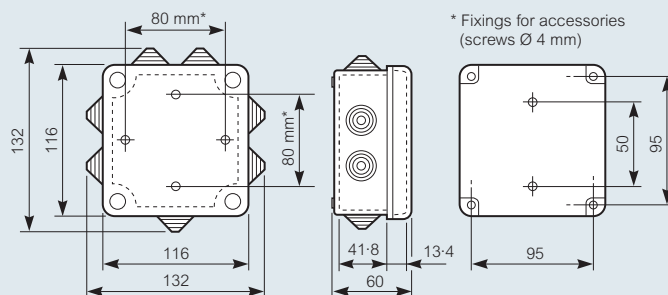

* Fixings for accessories (screws Ø 4 mm)

Plexo weatherproof boxes

IP 55 - IK 07



0921 28



0359 40



Technical information and dimensions (p. 39)

IP 55 - IK 07
 Grey RAL 7035
 Conform to EN 60695-2-1
 Temperature rating : - 25 °C to + 40 °C
 Undrilled with smooth sides

Pack	Cat. Nos.	Weatherproof boxes – class II
5	0921 28	Self-extinguishing 650 °C Polystyrene box and polypropylene cover - halogen free With fixing slots for easy alignment - use 5 mm Ø screws Clip-on plain cover Nominal internal dimensions : Height x Width x Depth (mm) 80 x 80 x 45 Mounting by : • either internal fixing points - use 5 mm Ø screws • or at three corners outside the wiring area - use 4 mm Ø screws Provision for anti-tamper seal Cover with 4 x 1/4 turn fixings, indicated I-O, can be retained open during installation Nominal internal dimensions : Height x Width x Depth (mm) 105 x 105 x 55
5	0921 38	

Pack	Cover		Weatherproof boxes – class II	
	Plain	Transparent		
1	0359 00		Self-extinguishing 750 °C Polypropylene box Plain cover : polypropylene ⁽³⁾ Transparent cover : polycarbonate Halogen free Class II protection ensured by the mounting screw protection plugs Detachable clip-on cover retainer (except 310 x 240 and 360 x 270 boxes) Side mounts for IP 2X terminals provided (except for 130 x 75 x 74 mm boxes) 1/4 turn fixings to seal cover With fixing slots for easy alignment Option mounting equipment on rail or plain plate Nominal internal dimensions : Height x Width x Depth (mm)	
1	0359 30 ⁽¹⁾			
1	0920 32			
1	0359 40 ⁽¹⁾			
1	0920 42			
1	0359 50 ⁽¹⁾	0359 51 ⁽¹⁾		
1	0359 60 ⁽¹⁾	0359 61 ⁽¹⁾		
1	0359 70 ⁽²⁾	0359 71 ⁽²⁾		
1	0359 80 ⁽²⁾			
1	0359 90 ⁽²⁾			
				130 x 75 x 74 130 x 130 x 74 130 x 130 x 74 (10 membrane gland fitted for 4-25 mm cable or conduit) 155 x 110 x 74 155 x 110 x 74 (10 membrane gland fitted for 4-25 mm cable or conduit) 180 x 140 x 86 220 x 170 x 86 270 x 170 x 86 310 x 240 x 124 360 x 270 x 124

(1) Accepts Cat. No. 0358 00 hinges
 (2) Accepts Cat. No. 0358 01 hinges
 (3) Except Cat. No. 0359 80 : polycarbonate

Plexo weatherproof boxes

IP 66 - IK 08



0350 13



0350 28



0358 00



0358 02



Technical information and dimensions (p. 39)

Pack	Cat. Nos.	Weatherproof boxes – class II 500 V
1	0350 07	IP 66 - IK 08 Grey TO 29 Conform to EN 60695-2-1 Temperature rating : - 25 °C to + 80 °C Undrilled with smooth sides Self-extinguishing 750 °C Polycarbonate - halogen free Detachable clip-on cover retainer (except for 310 x 240 and 360 x 270 mm boxes) Side mounts for IP 2X terminals provided (except for 130 x 75 x 74 mm boxes) Sealable plain cover with captive 1/4 turn fixings Nominal internal dimensions : Height x Width x Depth (mm)
1	0350 13 ⁽¹⁾	130 x 75 x 74
1	0350 17 ⁽¹⁾	130 x 130 x 74
1	0350 22 ⁽¹⁾	155 x 110 x 74
1	0350 28 ⁽¹⁾	180 x 140 x 86
1	0350 33 ⁽²⁾	220 x 170 x 86
1	0350 44 ⁽²⁾	270 x 170 x 86
1	0350 47 ⁽²⁾	310 x 240 x 124
1		360 x 270 x 124

Pack	Cat. Nos.	Accessories	
		Metal mounting plates	Set of 2 hinges ⁽¹⁾
		Galvanised steel - 1.5 mm thick For box size :	UV protected polyamide in dark grey (RAL 7016) For box 130 x 130 mm to 270 x 170 mm
5	0358 10	130 x 130 mm	For box 310 x 240 mm to 360 x 270 mm
5	0358 11	155 x 110 mm	
5	0358 12	180 x 140 mm	
5	0358 13	220 x 170 mm	
5	0358 14	270 x 170 mm	
5	0358 15	310 x 240 mm	
5	0358 16	360 x 270 mm	
1	0358 00		
1	0358 01		
1	0358 02		

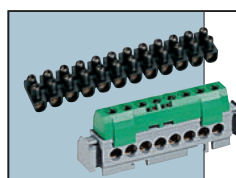

For Nylbloc terminal strips and distribution blocks

see p. 41 and 42-45

(1) Not suitable for PVC range

Plexo weatherproof boxes

IP 55 - IK 07 and IP 66 - IK 08

■ Dimensions (mm)

Cat. No. 0921 28

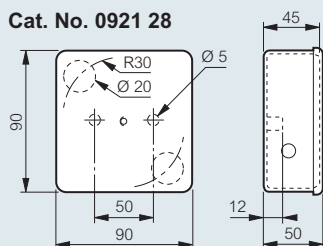

Cat. No. 0921 38

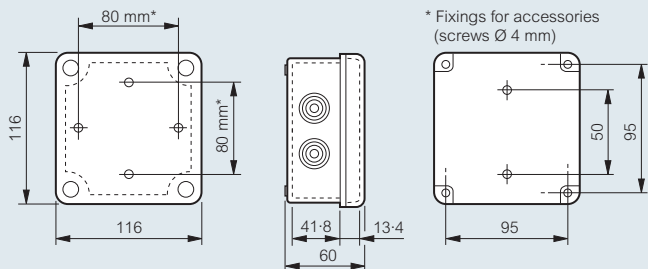

Boxes IP 55 – IK 07 and IP 66 – IK 08

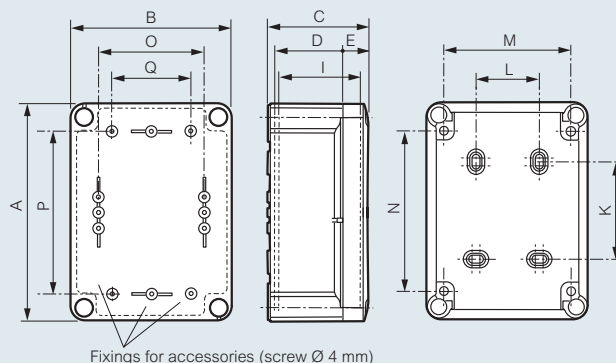

Fixings for accessories (screw Ø 4 mm)

Boxes	Dimensions (mm)						Fixing points (mm)				Fixing accessories (screw Ø 4 mm)			
	Cat. Nos.	A	B	C	D	E	I	K	L	M	N	O	P	Q
0359 00 0350 07 ⁽¹⁾	140	85	81	56	18	67	70	-	65	120	51	106	-	-
0359 30 0350 13	150	150	81	56	18	67	54	70	120	103	106	106	84	
0359 40 0350 17	175	130	81	56	18	67	79	50	100	128	86	131	64	
0359 50/51 0350 22	200	160	94	69	18	80	104	50	130	153	116	156	94	
0359 60/61 0350 28	240	190	94	69	18	80	144	80	160	193	146	196	124	
0359 70/71 0350 33	290	190	94	69	18	80	194	80	160	243	146	246	122	
0359 80 0350 44	332	262	132	97	27	116	220	160	222	276	200	260	150	
0359 90 0350 47	382	292	132	97	27	116	270	190	252	326	230	310	150	

(1) Not suitable for direct mounting of IP 2x terminals, use with DIN rail or 12 x 2 mm metal rail (Cat. No. 0048 19 p. 42)

Cat. Nos. 0920 32 and 0920 42

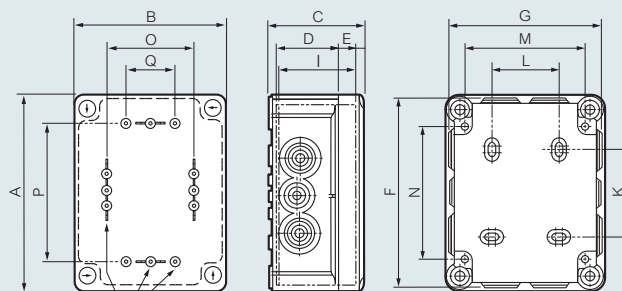

Fixings for accessories (screw Ø 4 mm)

Boxes	Dimensions (mm)							Fixing points (mm)				Fixing accessories (screw Ø 4 mm)				
	Cat. Nos.	A	B	C	D	E	I	F	G	K	L	M	N	O	P	Q
0920 32	150	150	81	56	18	67	149	54	149	70	120	103	106	106	84	
0920 42	175	130	81	56	18	67	173	54	128	79	50	100	128	86	131	64

■ Metal mounting plates

Cat. Nos.	A (mm)	B (mm)	C (mm)	D (mm)
0358 10	114	114	106	106
0358 11	94	139	86	131
0358 12	124	164	116	156
0358 13	154	204	146	196
0358 14	154	254	146	246
0358 15	211	271	200	260
0358 16	241	321	230	310

■ IP 2x terminal acceptance⁽²⁾ chart (see p. 43)

Not suitable for direct mounting on to PVC range nor 130 x 75 x 74 mm boxes

Boxes	4 way	8 way	13 way	17 way	22 way	28 way
130 x 130 x 74	x	x	-	-	-	-
155 x 110 x 74	x	x	x	-	-	-
180 x 140 x 86	x	x	x	-	-	-
220 x 170 x 86	x	x	x	x	x	-
310 x 240 x 124	x	x	x	x	x	x
360 x 270 x 124	x	x	x	x	x	x

(2) Also accepts partly shrouded terminals

■ Thickness of walls

Upto 270 x 170 box = 2 mm
Above this size = 3 mm

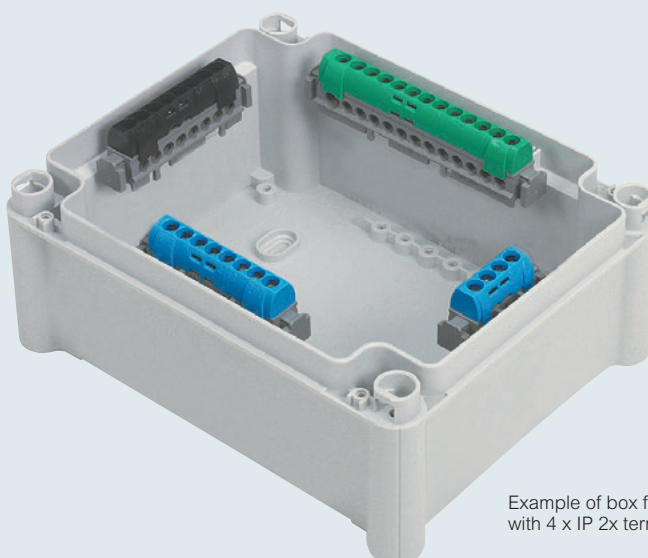

Example of box fitted with 4 x IP 2x terminals

Plexo weatherproof boxes

increased depth PVC range



0921 22

0350 43

Dimensions (opposite and p. 41)

Grey RAL 7035

Operating temperature : - 20 °C to +50 °C

PVC box and cover

Self-extinguishing : 750 °C for Cat. Nos. 0350 43 and 0922 84

960 °C for Cat. Nos. 0350 58 and 0921 22

Deep weatherproof plastic industrial equipment boxes with smooth sides

Fixing options :

- inside : 4 oblong holes at back of box

- outside : cabling volume at 4 corners with Ø4 screws

- with wall mounting brackets (Cat. No. 0364 08) for 310 x 240 boxes

Option of mounting equipment on rail or on plain plate at back of box

1/4 turn opening/closing

Pack	Cat. Nos.	Weatherproof boxes – IP 55
		Nominal internal dimensions : Height x Width x Depth (mm)
		Depth 140 mm
2	0921 22	IK 07 - IP 55 220 x 170 x 140 - (1/4 turn cover fixings)
		Depth 154 mm
2	0350 43	IK 08 - IP 55 265 x 174 x 154 - (1/4 turn cover fixings with hinges)
1	0350 58	359 x 265 x 154 - (1/4 turn cover fixings with hinges)
		Depth 160 mm
1	0922 84	IK 08 - IP 55 310 x 240 x 160 - (1/4 turn cover fixings with hinges)

Accessories

Metal mounting plates

Galvanised steel - 1.5 mm thick
For PVC box size :

5	0350 90	220 x 170 mm
5	0350 92	265 x 174 mm
5	0350 93	310 x 240 mm
5	0350 94	359 x 265 mm

Set of 4 wall mounting brackets

1	0364 08	For PVC box size 310 x 240 mm only
---	---------	------------------------------------

PVC boxes are not provided with side mounts for IP 2x terminals

Plexo weatherproof boxes

increased depth PVC range

■ Dimensions (mm)

Cat. No. 0921 22

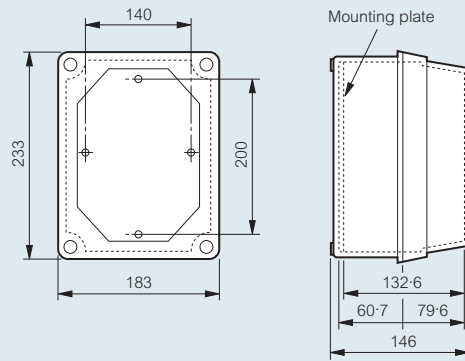

Fixing dimensions

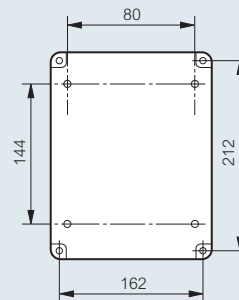

Cat. Nos. 0350 43/58

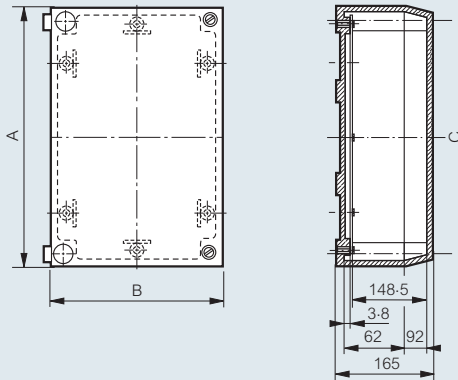

Fixing dimensions

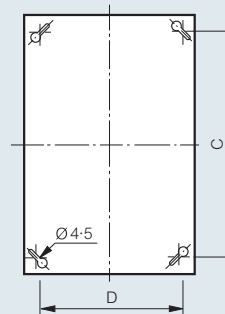

Cat. Nos.	Dimensions		Fixing points		Weight (kg)
	A (mm)	B (mm)	C (mm)	D (mm)	
0350 43	273	182	246	155	1.08
0350 58	367	273	340	246	1.80

Plexo weatherproof boxes

increased depth PVC range (continued)

■ Dimensions (mm)

Cat. No. 0922 84

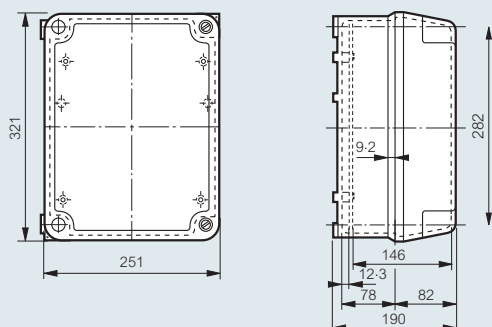

Fixing dimensions

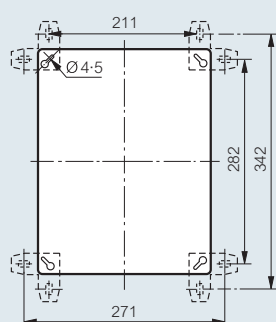

■ Mounting plates for PVC boxes

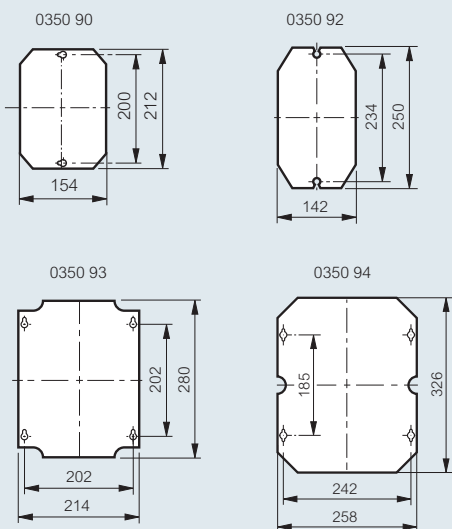

terminal strips

Nylbloc

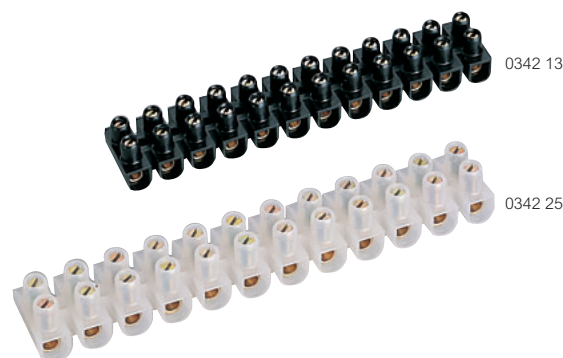

Pack	Cat. Nos.	Nylbloc terminal strips					
		12 way strips with captive screws Supplied with screws undone Flame retardant polypropylene (-25 °C to +100 °C) Insulation voltage : 250 V according to EN 60998-2-1 Use at 400 V integrated in a series of products that comply with the requirements of EN 60664-1, pollution degree 2, overload category III Ambient temperature from -25 °C to +55 °C					
		Capacity (mm ²)	Nom. rating (A)	Diameter Ø	Current max. (A)	Dimensions (mm)	
	Black						
10	0342 11	4	2.5	2.5	24	15.6 x 94 x 12.3	
10	0342 13	6	6	3.5	41	18 x 107 x 14.4	
10	0342 15	10	10	4.5	57	20.8 x 135.1 x 17.4	
10	0342 17	16	16	5.5	76	24.2 x 156.8 x 22.5	
10	0342 19	25	25	7	101	33 x 214 x 27.5	
	White						
10	0342 21	4	2.5	2.5	24	15.6 x 94 x 12.3	
10	0342 23	6	6	3.5	41	18 x 107 x 14.4	
10	0342 25	10	10	4.5	57	20.8 x 135 x 17.4	
10	0342 27	16	16	5.5	76	24.2 x 156.8 x 22.5	



For Plexo weatherproof boxes

see p. 36-40

distribution terminal blocks

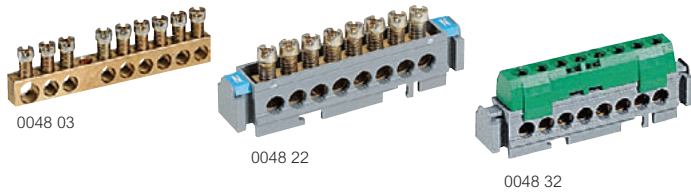

Conform to standard IEC 60998-2-1
 Supplied ready for use (screws captive and backed-off)
 100 A max. - 400 V~ with 25 mm² incoming
 80 A max. - 400 V~ with 16 mm² incoming
 Ipk (kA) 60 : Icw (kA) 3-5

Pack	Cat. Nos.	Unshrouded terminal blocks		
		Fix using M4 dia. screw		
		Incoming capacity	Outgoing capacity	Terminal length (mm)
10	0048 01	1 x 6 to 25 mm ²	4 x 1.5 to 16 mm ²	45
10	0048 03	1 x 6 to 25 mm ²	8 x 1.5 to 16 mm ²	73
10	0048 05	1 x 6 to 25 mm ²	14 x 1.5 to 16 mm ²	122
10	0048 06	1 x 6 to 25 mm ²	19 x 1.5 to 16 mm ²	157
10	0048 07	1 x 6 to 25 mm ²	24 x 1.5 to 16 mm ²	192

		Partly shrouded terminal blocks on base		
		For fixing to 12 x 2 mm rail		
		Supplied with Duplix markers ⁽¹⁾		
		Incoming capacity	Outgoing capacity	Terminal length (mm)
10	0048 20 ⁽¹⁾	-	4 x 1.5 to 16 mm ²	47
10	0048 22 ⁽¹⁾⁽²⁾	-	8 x 1.5 to 16 mm ²	75
10	0048 24 ⁽¹⁾⁽²⁾	1 x 6 to 25 mm ²	12 x 1.5 to 16 mm ²	113
10	0048 25 ⁽¹⁾	1 x 6 to 25 mm ²	16 x 1.5 to 16 mm ²	141

		Fully shrouded terminal blocks providing finger protection IP 2x		
		For fixing to 12 x 2 mm rail		
		Incoming capacity	Outgoing capacity	Terminal length (mm)
10	0048 50	-	4 x 1.5 to 16 mm ²	47
10	0048 52 ⁽²⁾	-	8 x 1.5 to 16 mm ²	75
10	0048 54 ⁽²⁾	1 x 6 to 25 mm ²	12 x 1.5 to 16 mm ²	113
10	0048 55	1 x 6 to 25 mm ²	16 x 1.5 to 16 mm ²	141
10	0048 56	1 x 6 to 25 mm ²	21 x 1.5 to 16 mm ²	176
10	0048 58	2 x 6 to 25 mm ²	33 x 1.5 to 16 mm ²	276
		Earth (green)		
10	0048 30	-	4 x 1.5 to 16 mm ²	47
10	0048 32 ⁽²⁾	-	8 x 1.5 to 16 mm ²	75
10	0048 34 ⁽²⁾	1 x 6 to 25 mm ²	12 x 1.5 to 16 mm ²	113
10	0048 35	1 x 6 to 25 mm ²	16 x 1.5 to 16 mm ²	141
10	0048 36	1 x 6 to 25 mm ²	21 x 1.5 to 16 mm ²	176
10	0048 38	2 x 6 to 25 mm ²	33 x 1.5 to 16 mm ²	276

		Fully shrouded terminal blocks 3 phase + neutral (3 black + 1 blue)		
1	0048 14	Incoming capacity	Outgoing capacity	Terminal length (mm)
		Neutral x 1		
		1 x 4 to 25 mm ²	12 x 1.5 to 16 mm ²	
		Phase x 3		227
		1 x 1.5 to 16 mm ²	3 x 1.5 to 16 mm ²	

		Supports for terminal blocks		
		Terminal side support		
1	0048 10	Consists of two side supports for positioning of up to 4 x IP 2x terminal blocks with the same dimensions to create a 2, 3 or 4 pole distribution block		
		Terminal rail support		
5	0048 11	Adaptor support for or rail. Provides a firm fixing allowing IP 2x terminal blocks to be side or top mounted on to adaptor		
		Rail		
10	0048 19	1 metre length of 12 x 2 mm terminal mounting rail - accepts partly and fully shrouded terminals		

(1) Each terminal supplied with :
 - 2 green Duplix markers (+) - 2 blue Duplix markers (N) - 2 red Duplix markers (L)
 (2) Can be fixed directly to DIN rail without accessory

distribution terminal blocks

■ **Connection protection**

Fixes into side supports to construct a distribution block

IP 2x terminals are the ideal companion for Plexo boxes, see p. 36-40

■ **Use of terminal supports Cat. No. 0048 10**

Terminal supports Cat. No. 0048 10 fitted with fully shrouded terminals providing custom made distribution

Adaptor support Cat. No. 0048 11 showing method of fixing terminals

For Plexo weatherproof boxes

see p. 36-40

distribution blocks 40 to 160 A

modular style - rail or screw fixing

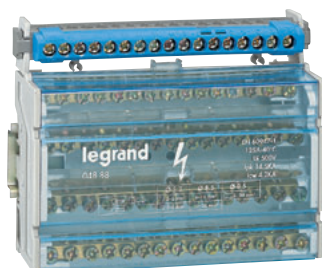

0048 88 + 0048 45



0048 79

Conform to standard EN 60947-1
 Insulation voltage according to EN 60947-1/IEC 60664-1 : 500 V
 Impulse (surge) voltage (Uimp) : 8 kV
 Degree of pollution : 3 (conductive dust)
 Self-extinguishing 960 °C for supports and active parts
 Connection with or without Starfix ferrules

Pack	Cat. Nos.	Modular style blocks						
		Fixing on rail or on plate using 2 screws Supplied complete with rear insulated plate and transparent cover Bar identification possible using CAB 3 markers When installing under a front plate a blank can also be clipped on to the front plate Additional IP 2x terminals can be fitted (see table opposite)						
Double pole								
Equipped with 2 bars								
		Ways per bar	Capacity	Ipk peak withstand current (kA)	Icw (kA)	Number of modules		
			rigid (mm ²)	flexible (mm ²)				
5	0048 81	40 A	11	1.5 to 4 6 to 16	0.75 to 4 4 to 10	20	3	6
10	0048 80	100 A	5	2.5 to 10 10 to 25	1.5 to 10 6 to 16	20	4.5	4
5	0048 82	125 A	11	2.5 to 10 10 to 25 10 to 35	1.5 to 10 6 to 16 10 to 25	18	4.5	8
Four pole								
Equipped with 4 bars								
		Ways per bar	Capacity	Ipk peak withstand current (kA)	Icw (kA)	Number of modules		
			rigid (mm ²)	flexible (mm ²)				
5	0048 85	40 A	11	1.5 to 4 6 to 16	0.75 to 4 4 to 10	20	3	6
10	0048 84	100 A	5	2.5 to 10 10 to 25	1.5 to 10 6 to 16	20	4.5	4
5	0048 86	125 A	7	2.5 to 10 10 to 25 10 to 35	1.5 to 10 6 to 16 10 to 25	20	4.5	6
5	0048 88 ⁽¹⁾	125 A	11	2.5 to 10 10 to 35	1.5 to 10 6 to 25 ⁽¹⁾	14.5	4.2	8
1	0048 79 ⁽¹⁾	160 A	1	35 to 70	35 to 70	27	8.4	10
			8	2.5 to 10	1.5 to 10			
			4	10 to 25	6 to 16			
			2	10 to 35	10 to 25 ⁽¹⁾			

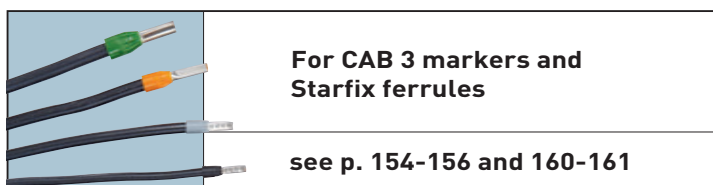

(1) Supplied with short ferrule

distribution blocks 40 to 160 A

modular style - rail or screw fixing

■ Dimensions

Double pole 40 - 100 - 125 A

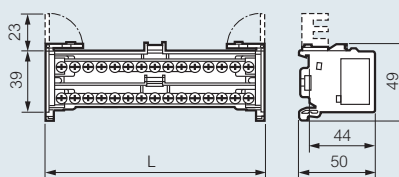

Cat. Nos.	Length (L)
0048 80	70
0048 81	105
0048 82	140
0048 84	70
0048 85	105
0048 86	105
0048 88	140
0048 79	179

Four pole 40 - 100 - 125 A

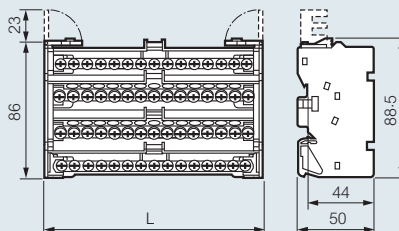

Four pole 160 A

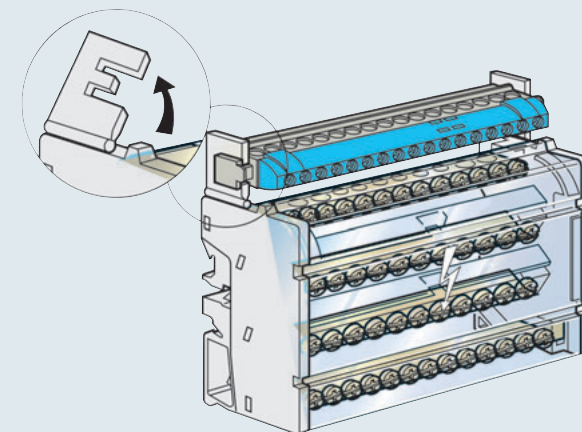
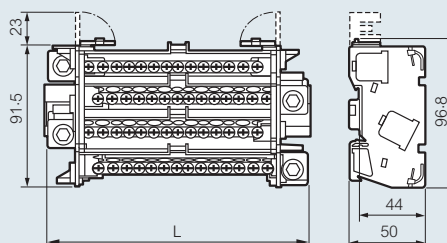

0048 88 + 0048 45

Extend your wiring capability using IP 2x fully shrouded terminals on the following :

(see p. 42)

Distribution block Cat. Nos.	IP 2x Terminal	Characteristics Voltage	Rating
0048 80	0048 32 ⁽¹⁾	400 V	80 A
0048 81	0048 34 ⁽¹⁾	400 V	40 A
0048 82	0048 35 ⁽¹⁾	400 V	100 A
0048 84	0048 42 ⁽²⁾	400 V	80 A
0048 85	0048 44 ⁽²⁾	400 V	40 A
0048 86	0048 44 ⁽²⁾	400 V	100 A
0048 88	0048 45 ⁽²⁾	400 V	100 A
0048 79	0048 45 ⁽²⁾	400 V	100 A

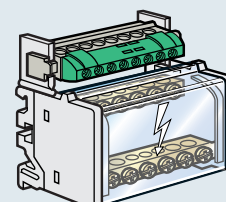

0048 80 + 0048 32

(1) (green cover)
 (2) (Neutral (blue cover))

distribution blocks 125 to 400 A

four pole



0374 00

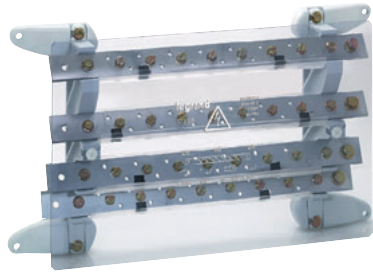

0373 08

Pack	Cat. Nos.	Extra-flat distribution blocks for lugs									
1	0374 47	<p>125 A screw type (60 mm depth) Ipk peak withstand current 25 kA Insulation voltage according to EN 60947-1/ IEC 60664-1 : 500 V Self-extinguishing : 960 °C</p> <p>Fix to \perp (15 mm high) or by M6 screws Four bars each equipped with :</p> <table border="1"> <tr> <td>Incoming</td> <td>Phase outgoing</td> <td>Neutral outgoing</td> <td rowspan="2">No. of 17.5 mm modules 16</td> </tr> <tr> <td>1 x 35 mm²</td> <td>10 x 16 mm² M5 screw</td> <td>17 x 16 mm² M5 screw</td> </tr> </table> <p>Clamp connection possible using connector Cat. No. 0373 65 (p. 45)</p>	Incoming	Phase outgoing	Neutral outgoing	No. of 17.5 mm modules 16	1 x 35 mm ²	10 x 16 mm ² M5 screw	17 x 16 mm ² M5 screw		
Incoming	Phase outgoing	Neutral outgoing	No. of 17.5 mm modules 16								
1 x 35 mm ²	10 x 16 mm ² M5 screw	17 x 16 mm ² M5 screw									
1	0374 00	<p>250 A (75.5 mm depth) Ipk peak withstand current 60 kA Insulation voltage according to EN 60947-1/ IEC 60664-1 : 1 000 V Self-extinguishing : 960 °C</p> <p>Fix to mounting plate by M6 screws Four bars each equipped with :</p> <table border="1"> <tr> <td>Incoming</td> <td>either</td> <td>Outgoing</td> </tr> <tr> <td>150 mm²</td> <td></td> <td>1 x 70 mm² or 1 x 50 mm² plus 1 x 35 mm² or 2 x 35 mm²</td> </tr> <tr> <td></td> <td>or</td> <td>1 connector Cat. No. 0374 03</td> </tr> </table>	Incoming	either	Outgoing	150 mm ²		1 x 70 mm ² or 1 x 50 mm ² plus 1 x 35 mm ² or 2 x 35 mm ²		or	1 connector Cat. No. 0374 03
Incoming	either	Outgoing									
150 mm ²		1 x 70 mm ² or 1 x 50 mm ² plus 1 x 35 mm ² or 2 x 35 mm ²									
	or	1 connector Cat. No. 0374 03									
1	0374 03	<p>Connector for Cat. No. 0374 00 converts outgoing terminal to :</p> <ul style="list-style-type: none"> • 1 x 1.5 to 6 mm² Ø 5.3 mm • 2 x 6 to 16 mm² Ø 7.5 mm <p>Dimensions : 29 x 29 x 16.8 mm</p> 									

Pack	Cat. Nos.	Stepped distribution blocks for lugs				
1	0373 95	<p>125 A (77 mm depth) Fix to \perp (15 mm high) or by M4 screws Four 12 x 4 mm bars each equipped with : • Five 2 x 10 mm² claw connectors per bar (not mounted)</p>				
1	0374 30	<p>125 A (125 mm depth) Fix to mounting plate by M6 screws Four 15 x 4 mm bars each equipped with :</p> <table border="1"> <tr> <td>Incoming</td> <td>Outgoing</td> </tr> <tr> <td>1 x 35 mm² - M8 screw</td> <td>5 x 25 mm² - M6 screw</td> </tr> </table>	Incoming	Outgoing	1 x 35 mm ² - M8 screw	5 x 25 mm ² - M6 screw
Incoming	Outgoing					
1 x 35 mm ² - M8 screw	5 x 25 mm ² - M6 screw					
1	0374 31	<p>160 A (125 mm depth) Fix to mounting plate by M6 screws Four 18 x 4 mm bars each equipped with :</p> <table border="1"> <tr> <td>Incoming</td> <td>Outgoing</td> </tr> <tr> <td>1 x 70 mm² - M8 screw</td> <td>5 x 35 mm² - M6 screw</td> </tr> </table>	Incoming	Outgoing	1 x 70 mm ² - M8 screw	5 x 35 mm ² - M6 screw
Incoming	Outgoing					
1 x 70 mm ² - M8 screw	5 x 35 mm ² - M6 screw					
1	0374 35	<p>250 A (155 mm depth) Fix to mounting plate by M6 screws Four 25 x 4 mm bars each equipped with :</p> <table border="1"> <tr> <td>Incoming</td> <td>Outgoing</td> </tr> <tr> <td>1 x 120 mm² - M10 screw</td> <td>5 x 50 mm² - M8 screw</td> </tr> </table>	Incoming	Outgoing	1 x 120 mm ² - M10 screw	5 x 50 mm ² - M8 screw
Incoming	Outgoing					
1 x 120 mm ² - M10 screw	5 x 50 mm ² - M8 screw					
1	0373 08	<p>400 A (107 mm depth) With front insulation sheet Four 32 x 5 mm bars equipped with :</p> <table border="1"> <tr> <td>Incoming</td> <td>Outgoing</td> </tr> <tr> <td>2 x Ø 8.5 mm holes for bar/flexible bar</td> <td>21 x M6 holes for 70 mm² max cable lugs</td> </tr> </table>	Incoming	Outgoing	2 x Ø 8.5 mm holes for bar/flexible bar	21 x M6 holes for 70 mm ² max cable lugs
Incoming	Outgoing					
2 x Ø 8.5 mm holes for bar/flexible bar	21 x M6 holes for 70 mm ² max cable lugs					

distribution blocks 125 to 400 A

four pole

■ Extra-flat distribution blocks for lugs

125 A Cat. No. 0374 47

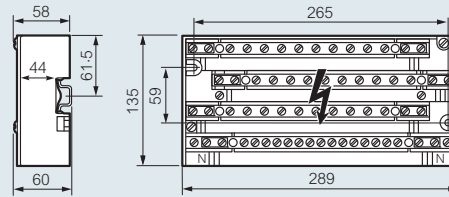

250 A Cat. No. 0374 00

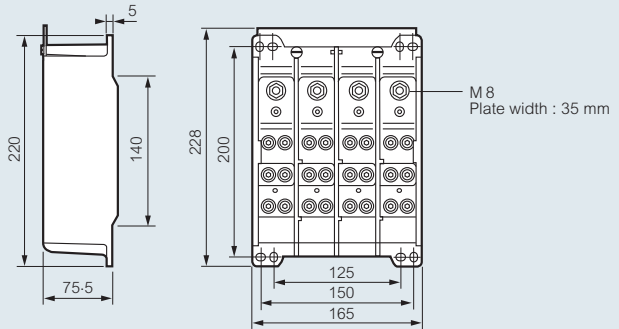

■ Stepped distribution blocks for lugs

125 A Cat. No. 0373 95 - Ipk peak withstand current 20 kA
 Insulation voltage according to EN 60947-1/IEC 60664-1 : 600 V
 Self-extinguishing : 850 °C

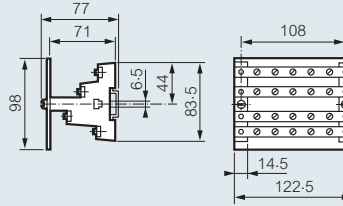

125/160/250 A Cat. Nos. 0374 30/31/35 - Ipk peak withstand current 35 kA
 Insulation voltage according to EN 60947-1/IEC 60664-1 : 1 000 V
 Impulse (surge) voltage (Uimp) : 12 kV
 Degree of pollution : 3 (conductive dust)
 Self-extinguishing : 850 °C

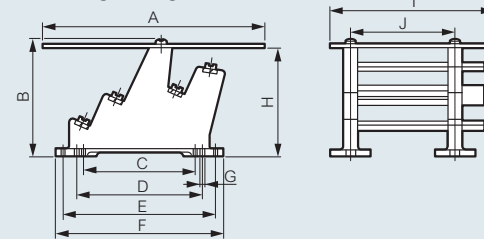

Dimensions (mm)

Rating	A	B	C	D	E	F	G	H	I	J
125 A	225	125	110	125	165	189	6.5	117.5	165	108
160 A	240	125	110	125	165	189	6.5	117.5	180	120
250 A	260	155	110	125	185	209	6.5	147.5	195	120

400 A (1) Cat. No. 0373 08 - Ipk peak withstand current 42 kA
 Insulation voltage according to EN 60947-1/IEC 60664-1 : 1 000 V
 Impulse (surge) voltage (Uimp) : 12 kV
 Degree of pollution : 3 (conductive dust)
 Self-extinguishing : 960 °C

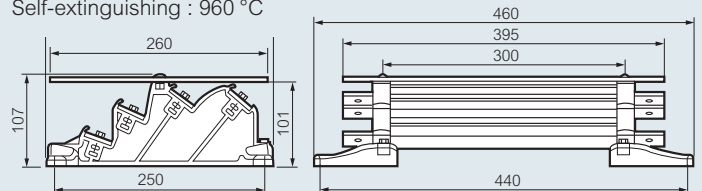

(1) It is recommended that the unit is fitted horizontally with a minimum face plate height of 300 mm

distribution blocks

self assembly



Insulated supports (maximum 280 A)

For assembling distribution blocks of varying lengths using bars and connectors below. Supplied with insulated screws for mounting optional protective cover (except 0373 98).

Pack	Cat. Nos.	Insulated supports (maximum 280 A)	Mounting type
5	0373 96	Set of 2 insulated 4 pole supports For bars 12 x 2 or 12 x 4 mm	DIN rail 0044 16 supplied or M4 screws not supplied
10	0373 98	Single pole supports For bars 12 x 2 or 12 x 4 mm	by M4 screws supplied
10	0374 37	For bars 15 x 4, 18 x 4 or 25 x 4 mm	

Copper connector bars

With threaded holes

		Size (mm)	Threaded holes Ø mm	Pitch	Max. thermal rating (A)	Length (mm)
10	0373 88	12 x 2	M5	18	110	990
10	0373 89	12 x 4	M5	18	160	990
10	0374 33	15 x 4	M6	18	200	990
10	0374 34	18 x 4	M6	18	245	990
10	0374 38	25 x 4	M6	18	280	990
4	0374 19	32 x 5	M6	25	450	1750

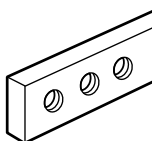

Connectors

Clamp type – For bars with threaded holes 12 x 4 (mm)

For one or two conductors
1.5 to 10 mm² (supplied with Ø 5 mm screw)

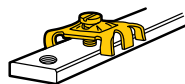

Cage type – For bare 12 x 4 mm bars

Capacity
100 0373 60 1.5 to 4 mm²
10 0373 61 6 to 16 mm²
10 0373 62 10 to 35 mm² (supplied with hexagonal 5 mm M6 screw)



Clips

For mounting on rail EN 60715 and 15 mm depth

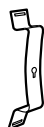

10	0044 16	10 mm width With threaded Ø 4 mm hole
----	---------	--

distribution blocks

self assembly

Copper connector bars with threaded holes

Cat. Nos. 0373 88/89

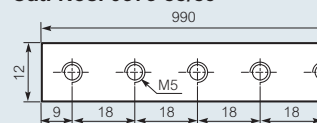

Cat. No. 0374 33/34

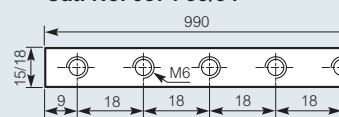

Cat. No. 0374 38

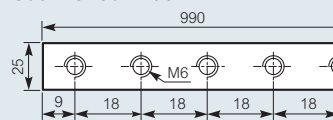

Cat. No. 0374 19

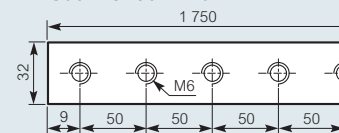

Cat. Nos.	Size	lthe (A)	lc (A)
0373 88	12 x 2	110	80
0373 89	12 x 4	160	125
0374 33	15 x 4	200	160
0374 34	18 x 4	245	200
0374 38	25 x 4	280	250
0374 19	32 x 5	450	400

Current ratings according to EN 60947-1 :

- lth : bars in free air
- lthe : bars enclosed with ventilation
- lc : bars totally enclosed in a weatherproof enclosure

Insulated supports four pole :

Insulation voltage according to EN 60947-1/IEC 60664-1 :
Cat. No. 0373 96 : 690 V - Impulse voltage (surge) (Uimp) : 8 kV
Degree of pollution (conductive dust) : 3
Distance between supports (mm)

Cat. Nos.	0373 96
Bar size	12 x 4 (12 x 2)
In (A)	125 (80)
Peak withstand current (kA)	
10	400 (200)
15	300 (150)
20	200 (125)
25	150 (100)
30	-
35	-
40	-

Cat. No. 0373 96

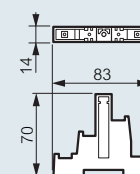

Insulated supports single pole

Insulation voltage according to EN 60947-1/IEC 60664-1 : 500 V
Impulse voltage (surge) (Uimp) : 8 kV
Degree of pollution (conductive dust) : 3

Cat. No. 0373 98

Front view for 12 x 2 mm bar

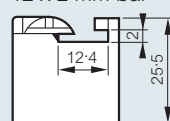

View from above

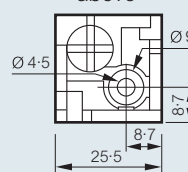

Front view for 12 x 4 mm bar

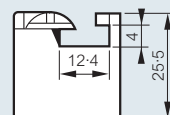

Cat. No. 0374 37

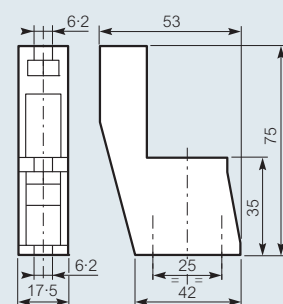

Max. space between 2 supports :
bar size 12 x 2 : 20 cm, 12 x 4 : 25 cm

The distance between supports can be determined using the chart. Select the peak withstand current (kA rating) and the distance between bars - dimension E (mm) after choosing your bar and support. Distance between supports (mm)

Cat. Nos.	0373 98				0374 37			
	Bar size				Bar size			
	12 x 2/12 x 4				15 x 4/18 x 4/25 x 4			
In (A)	80/125				160/200/245			
E (mm)	50	75	100	125	50	75	100	125
Peak withstand current (kA)								
10	400	600	800	-	350	600	750	-
15	300	450	600	800	250	400	500	700
20	250	350	450	600	150	225	300	375
25	200	250	300	400	125	150	200	250
30	-	-	-	-	100	125	150	175
35	-	-	-	-	-	100	125	150
40	-	-	-	-	-	-	-	-

Transcab®

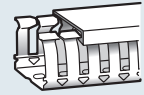

P. 50
Transcab
PVC panel
trunking

Transcab® open slot panel trunking

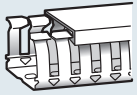

P. 50
Transcab
PC/ABS
halogen free
panel trunking



P. 50
Transcab
cutting tool



P. 50
Cable retainer,
marking and fixing
accessories and
braided sleeving



P. 51
Technical
information

Transcab® ...

uniquely innovative open slot trunking

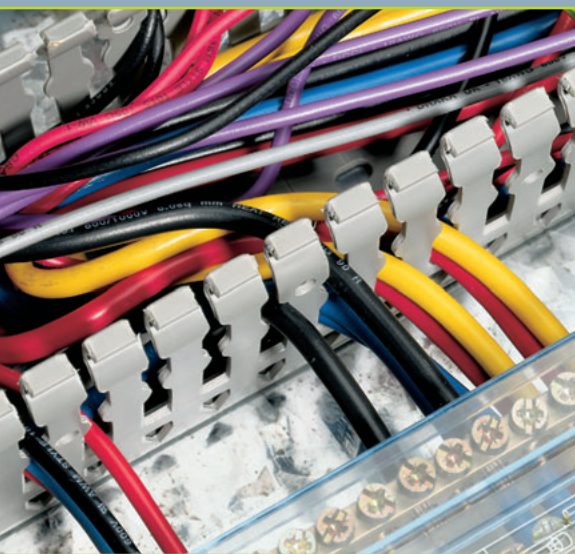

With its innovative snap to length design, Transcab is a quick and easy to install open slot panel trunking system that doesn't compromise on quality. And with its global standards approvals, Transcab is ideal for almost any industrial application.

Strength and flexibility

Transcab's durable PVC body consists of 6mm gaps and 6.5mm fingers with unique support ribs, providing strength and rigidity. Fingers are easily removed by snapping at support rib or base level to create T-junctions without the need for a saw.

FEATURES

- **Snap to length design** - for quick and simple installation without the need for a saw
- **Rounded fingers** - easily removed at support rib or base level to create T-junctions
- **Clip-on covers with raised lines** - for quick installation and easy label alignment
- **Available in PVC and PC/ABS halogen-free versions** - to suit a variety of applications
- **Sizes : width x height - from 15 x 25mm to 150 x 100mm**
: supplied in 2m lengths

ACCESSORIES

- **Unique cutting tool for removing support ribs** - Cat No. 0367 10
- **Cable retainer** - for vertical and inverted installations
- **Label holder clips to fingers** - for easy identification of cables





Using the specially designed tool, support bars can be easily and cleanly removed

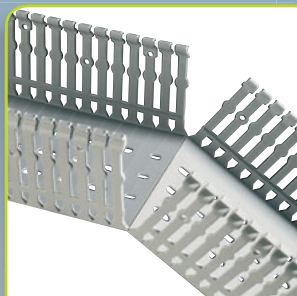

Once the support rib is removed, the base can be snapped to length

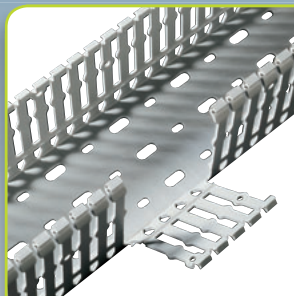

By removing individual support ribs, large gaps for T-junctions can be made without the need for a saw

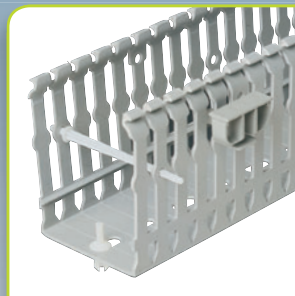

Cable retainers are available for horizontal and inverted installations. Label holders clip onto fingers for easy identification of cables

Transcab... innovative design and high quality materials combine to create a globally approved system that is quick and easy to install

TECHNICAL DATA

APPROVALS: EN 50085 Parts 2 and 3, UL and CSA

SLOTTING: Open with 6mm gaps

FLAMMABILITY: UL94 V-0 rated

OPERATING TEMPERATURE: -5 to + 60°C

COLOUR: Grey RAL 7030 (PVC), light grey RAL 7035 (PC/ABS halogen-free)

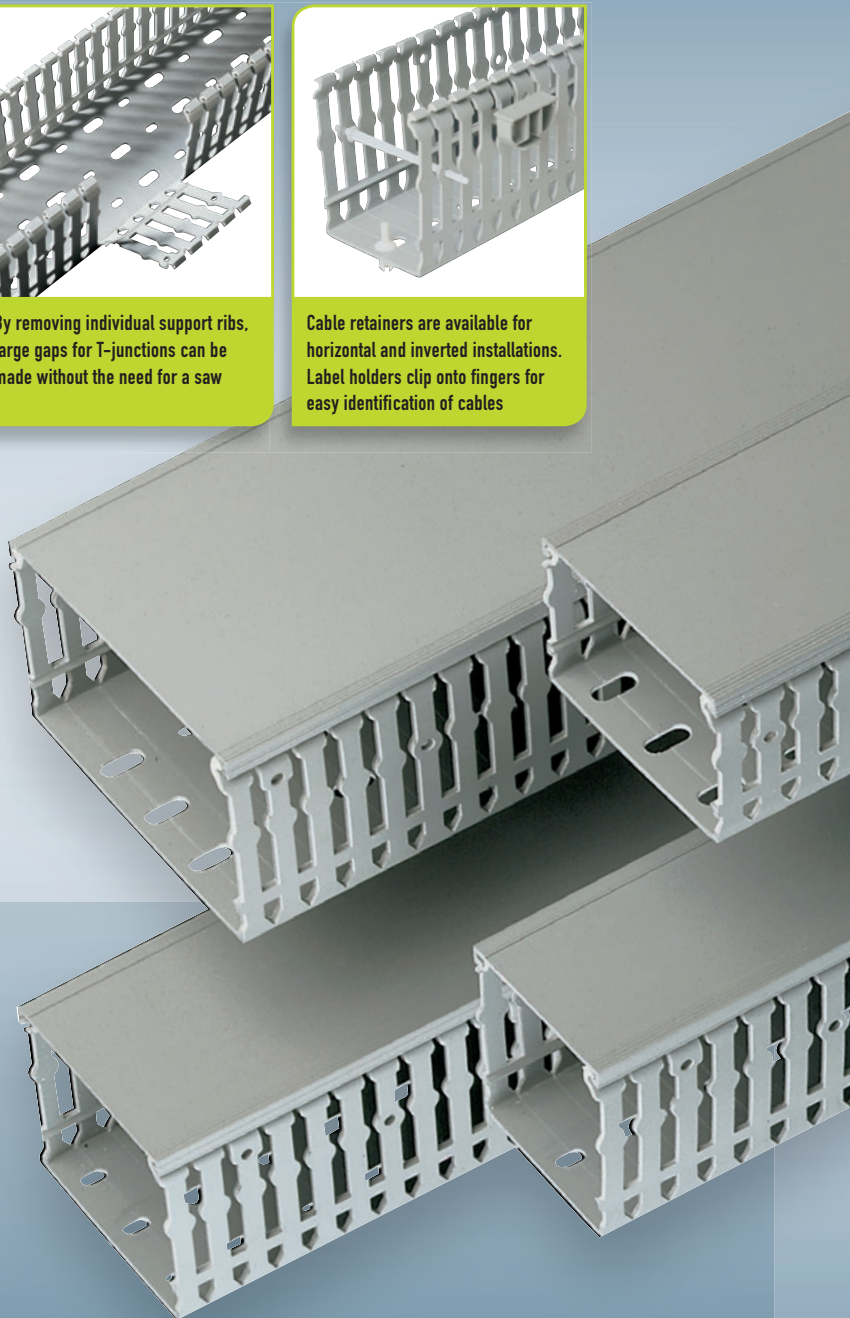

Transcab® open slot panel trunking

PVC and PC/ABS halogen free

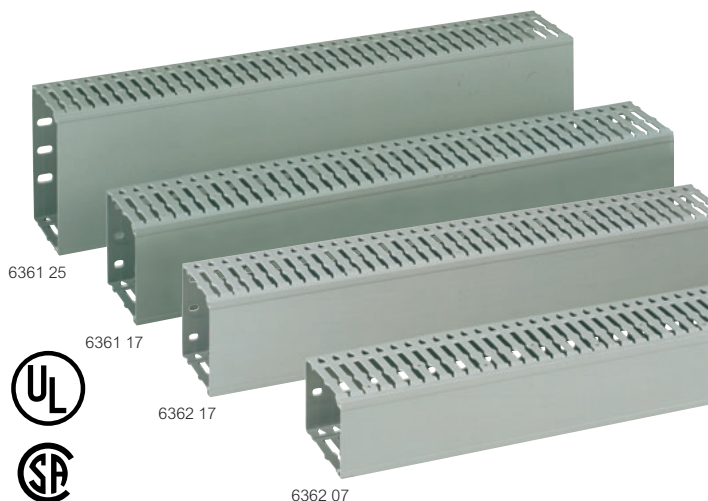

Dimensions and technical information (p. 51)
Accessories (opposite)

Conforms to EN 50085 Parts 2 and 3, UL and CSA
Material : PVC self-extinguishing or PC/ABS halogen free
Colour : grey RAL 7030 (PVC) or light grey RAL 7035 (PC/ABS)
PC/ABS range passes IEC 695-2-1 850 °C glow wire test
Operating temp. : -5 to +60 °C
UL classification : UL94 VO
Oxygen index : 43% (PVC) or 37% (PC/ABS) EN ISO 4589 (low fume)
Metric size body in 2 m lengths (6 mm gap/6.5 mm finger width)
DIN fixing centres of 12.5/25 mm
Maximum space for cables with good heat dissipation
Exit cables at terminal or base level

Plastic panel trunking (base + cover)

Pack	Cat. Nos.		2 metre lengths	
Metres per pack	PVC Grey RAL 7030	PC/ABS Grey RAL 7030 halogen free	Width x Height (mm)	Capacity (mm ²)
32	6360 95		15 x 25	264
60	6361 00		25 x 25	391
56	6361 05		40 x 25	692
40	6360 96		15 x 40	455
56	6361 01		25 x 40	720
48	6361 06		40 x 40	1 245
32	6361 11		60 x 40	1 932
24	6361 15		80 x 40	2 647
24	6361 19		100 x 40	3 363
56	6361 02	6362 02	25 x 60	1 159
48	6361 07	6362 07	40 x 60	2 007
32	6361 12	6362 12	60 x 60	3 115
24	6361 16		80 x 60	4 200
24	6361 20		100 x 60	5 307
40	6361 03		25 x 80	1 600
40	6361 08		40 x 80	2 717
32	6361 13	6362 13	60 x 80	4 216
24	6361 17	6362 17	80 x 80	5 715
16	6361 21		100 x 80	7 215
16	6361 25	6362 25	120 x 80	8 729
24	6361 09		40 x 100	3 354
24	6361 14		60 x 100	5 216
20	6361 18		80 x 100	7 078
16	6361 22		100 x 100	8 960
12	6361 23		150 x 100	13 683

Spare covers

Pack	Cat. Nos.		2 metre lengths	
Width (mm)	PVC	PC/ABS	15 - also used for marking ⁽¹⁾	
36	0370 10		25	
36	0370 11		40	
36	0370 12		60	
36	0370 13	6362 93	80	
36	0370 14	6362 94		

Transcab® accessories

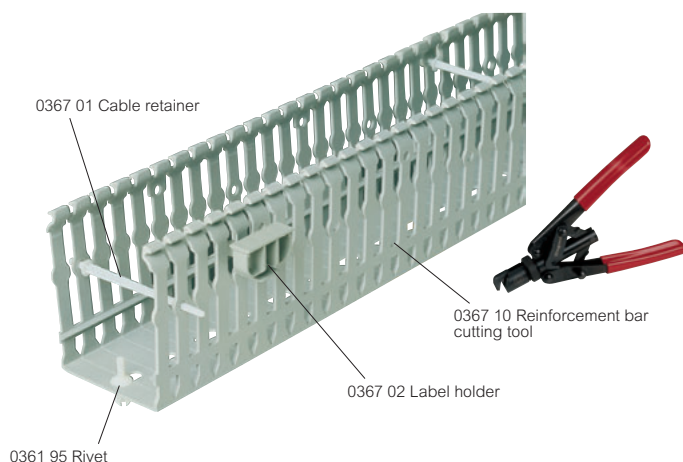

Pack	Cat. Nos.	Transcab cutting tool
1	0367 10	Tool for cutting 6 mm reinforcement bar

Pack	Cat. Nos.	Cable retainer
50	0367 01	Cable retainer - clips through trunking fingers

Pack	Cat. Nos.	Marking accessories
50	0367 02	Label holder Label holder - (clips to finger) for marking
10	0395 98	Black felt tip pen Indelible for marking



Pack	Cat. Nos.	Fixing accessories
100	6361 90	To DIN rail Insulated Nylon fixing screws Ø 6 mm for fixing the panel trunking to DIN rail
500	6361 95	To plain plate Insulated plastic rivets Ø 6 mm for fixing the panel trunking to a plain plate without the need of a screw
20	0366 42	To enclosure door Material : polyamide 6/6 For fixing the panel trunking to an enclosure door Fits under warning lights or other auxiliary controls attached to door Enables direct mounting of trunking by a manual 1/4 turn



Pack	Cat. Nos.	Braided sleeving
1	0366 38	Material : black polyester 25 m roll in dispenser box Used to protect runs of cables to door equipment Cable bunch diameter Ø 20 mm 10 - 30 mm
1	0366 39	Ø 30 mm 18 - 54 mm



(1) Clips to label holder Cat. No. 0367 02

Transcab® open slot panel trunking

■ Dimensions

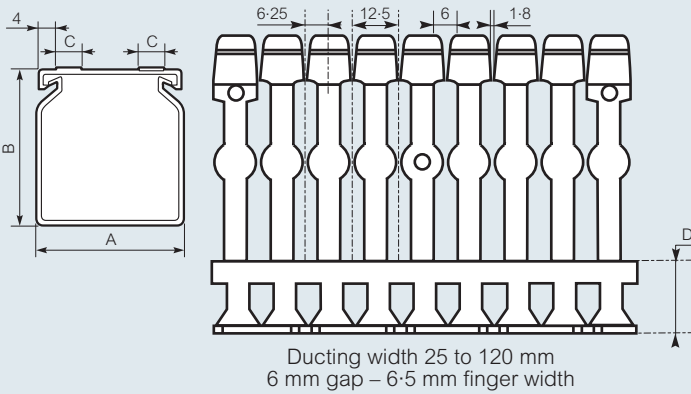

■ Detail of base perforations

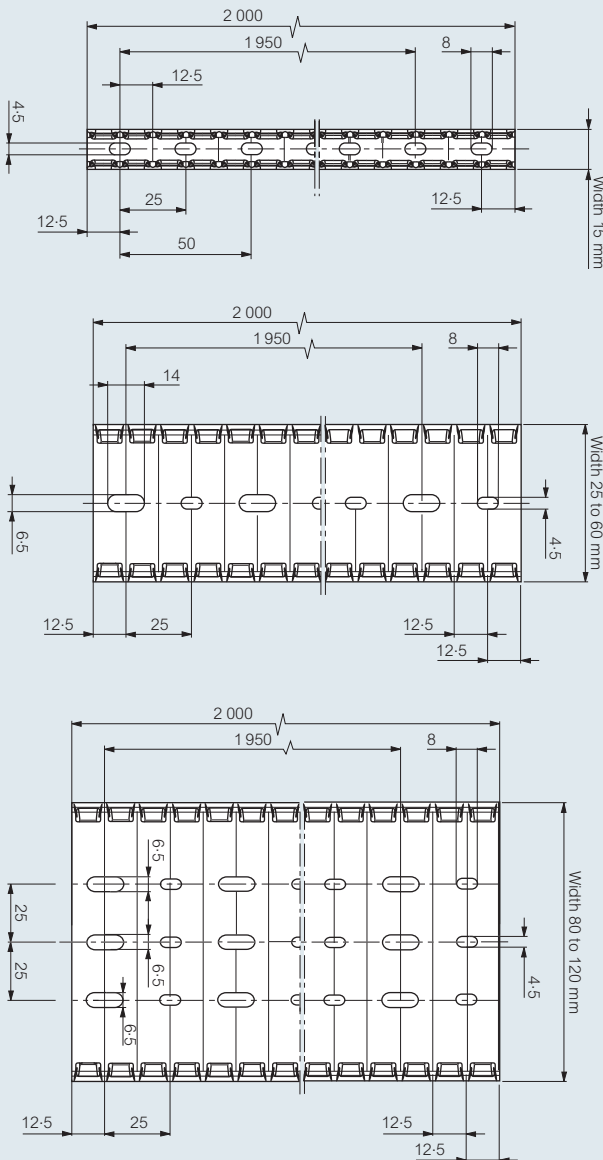

Transcab Cat. Nos.	A (mm)	B (mm)	C (mm)	D (mm)
6361 00	25	25	6	10.1
6361 01	25	40	5	12.6
6361 06	40	40	10	12.6
6361 11	60	60	–	16.1
6361 02	25	60	6	16.1
6361 07	40	60	10	16.1
6361 12	60	60	10	16.1
6361 16	80	60	10	16.1
6361 20	100	60	–	16.1
6361 03	25	80	–	18.6
6361 08	40	80	10	18.6
6361 13	60	80	10	18.6
6361 17	80	80	10	18.6
6361 21	100	80	–	18.6
6361 25	120	80	–	18.6
6361 14	60	100	–	20.6
6361 22	100	100	–	20.6
6361 23	150	100	–	20.6

Calculating the panel trunking usable cross section

Graph for H 05 V-K and H 07 V-K cables with 0.75 packing coefficient

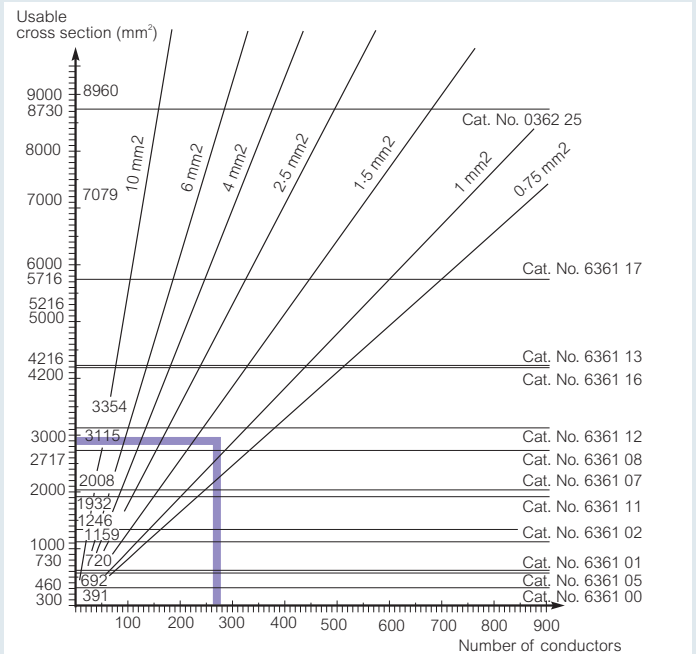

Example :

150 conductors 0.75 mm² → 1230 mm² cross section and
120 conductors 1.5 mm² → 1700 mm² cross section
Makes a total of 2930 mm²

The correct panel trunking is Cat. No. 6361 12, 60 x 60 mm, with a capacity of 3115 mm²

Faster base build without a saw

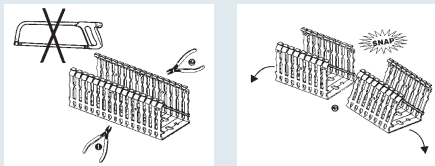

Remove reinforcement bars at required length and break

'T' junctions made easy

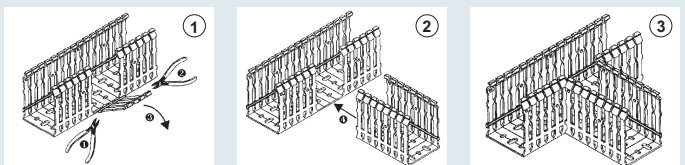

- 1 Clip out the required section width reinforcement bars and snap out section
- 2 Form tee section and fix into place
- 3 Ready for wiring – cut cover to suit

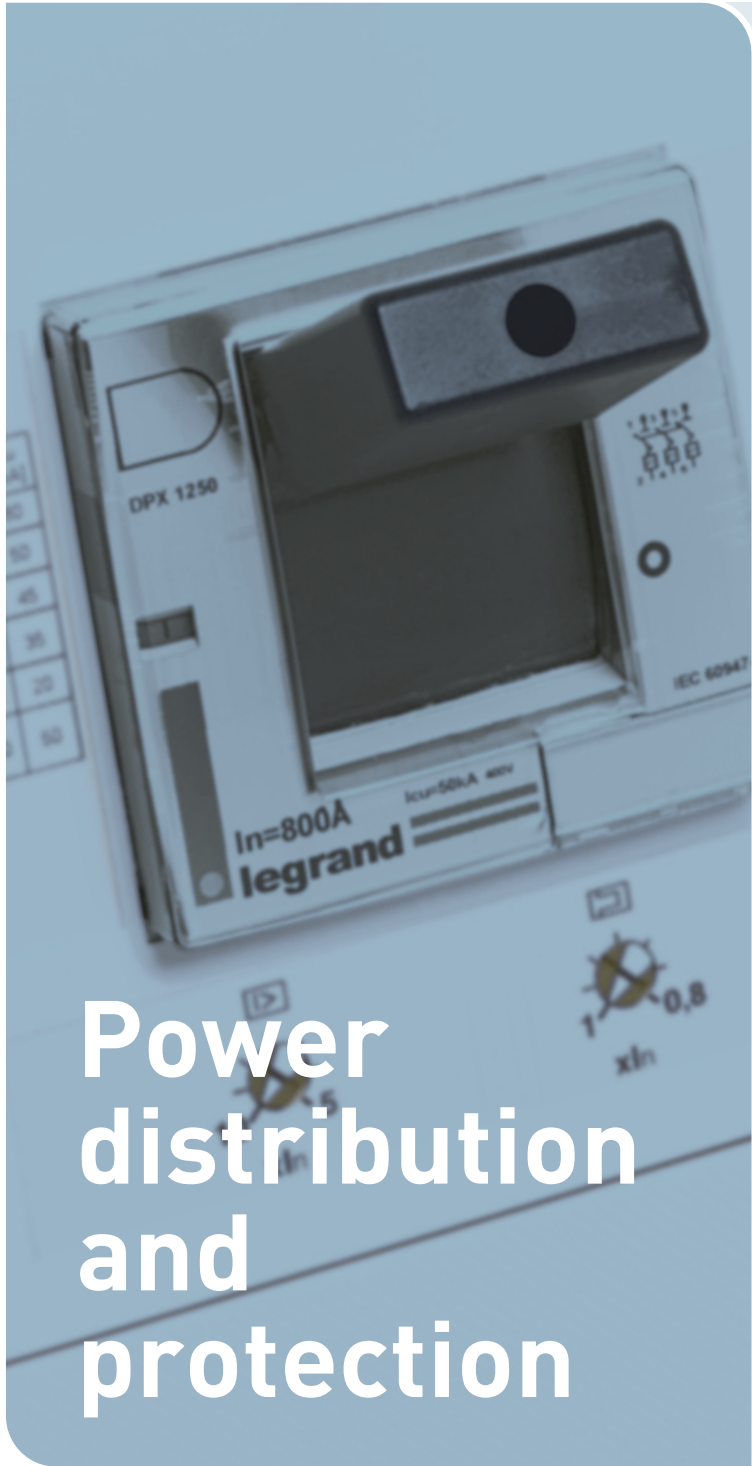

Power distribution and protection

Distribution boards



P. 56
Type B
distribution boards
selection chart

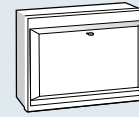

P. 61
Type A
distribution
boards

MCCB protection devices



P. 62
DPX MCCBs
selection chart

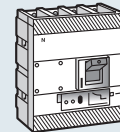

P. 68
DPX 1250
MCCBs

MCB/RCD/RCBO protection devices

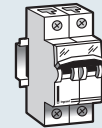

P. 79
DX-H
MCBs

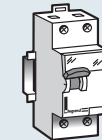

P. 83
DX
RCDs

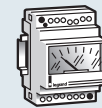

P. 85
Metering

Fuse carriers and fuses

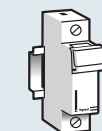

P. 89
Modular
fuse carriers



P. 93
Blade type
cartridge
fuses

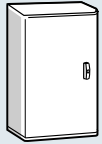

P. 58
Type B
standard
distribution
boards

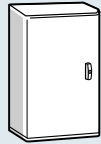

P. 58
Type B
flexible
distribution
boards

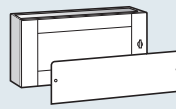

P. 59
Type B
distribution
board
accessories



P. 60
Technical
information



P. 61
Technical
information

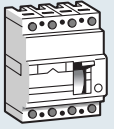

P. 64
DPX 125
MCCBs

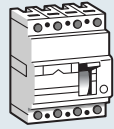

P. 65
DPX 250 ER
MCCBs

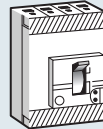

P. 66
DPX 250
MCCBs

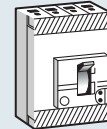

P. 67
DPX 630
MCCBs



P. 68
Control and
signalling
auxiliaries



P. 69
Technical
characteristics
and curves



P. 75
Selectivity table



P. 77
Technical
information

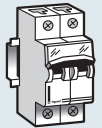

P. 79
DX-D
MCBs



P. 80
DX MCBs
technical
information



P. 81
DX tripping
and operating
curves



P. 82
Discrimination /
selectivity tables

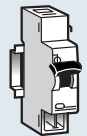

P. 83
DX
MCB/RCD
auxiliaries

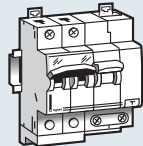

P. 84
DX
RCBOs



P. 88
Technical
information



P. 87
Metering
technical
information



P. 88
Modular
DIN rail
equipment
dimensions

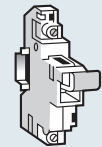

P. 89
SP
fuse carriers



P. 89
Modular fuse
carriers technical
information

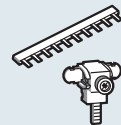

P. 90
Modular fuse
carrier and device
accessories



P. 91
Cylindrical
cartridge
fuses



P. 95
Technical
information

Power distribution and protection

Legrand's reputation for providing high quality power and distribution systems is second to none.

From rugged enclosures to a wide range of protection modules, each component is designed with innovation at the forefront of the process.

MCCBs



TECH DATA -
 Breaking capacity: 16kA, 25kA, 36kA, 50kA, 70kA
 Pole range: single to 4 pole
 Current rating: 16A to 800A

MCBs

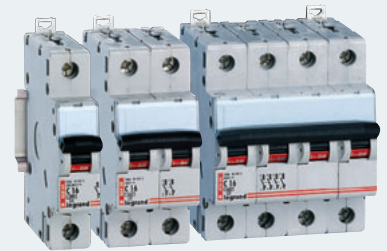

TECH DATA -
 Breaking capacity: 6kA, 10kA
 Pole range: single to 4 pole
 Current rating: 1A to 125A
 Tripping characteristics: Type B, C, D



Uniquely innovative... uniquely flexible

Legrand's type B distribution boards are available in standard and flexible versions. Flexible boards can be customised to individual requirements with a range of Legrand's modular devices, including MCCBs, MCBs, time switches and contactors. Modular devices integrate into the main pan assembly without the need for an extension box.

Type A boards with 6 to 18 outgoing ways are also available, (see p. 61).

RCDs



TECH DATA –
Pole range: 2 and 4 pole
Current rating: 16A to 100A
Types: A, AC
Sensitivity: 10mA, 30mA, 100mA, 300mA

RCBOs

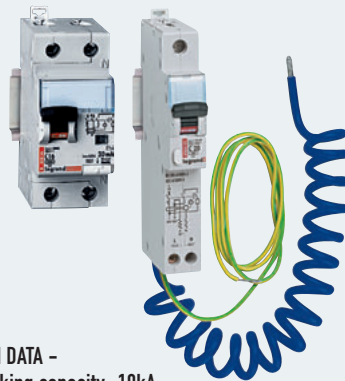

TECH DATA –
Breaking capacity: 10kA
Pole range: single pole + neutral to 4 pole
Current rating: 3A to 63A
Tripping characteristics: Type B, C
Sensitivity: 10mA, 30mA, 100mA, 300mA

FUSES AND FUSE CARRIERS



In addition to DIN rail mounted protection devices, Legrand offers a comprehensive range of cylindrical fuses, blade fuses and modular fuse carriers.
 see p. 89 to 95



Energy metering... putting you in control

Legrand's range of digital and analogue ammeters and voltmeters measure, meter and clearly display energy levels, enabling consumption levels to be controlled.

See p. 85 to 87



Related products:

From medium duty EdM cast resin transformers to 25 - 5000 A busbar from the Electrak and Zucchini product portfolio, contact Legrand's power distribution division on + 44 (0) 845 605 4333

type B distribution boards and devices

selection chart

TYPE B DISTRIBUTION BOARDS 125 A TP & N – STANDARD

TP & N – STANDARD	Number of ways (triple pole)					
	4	6	8	12	16	24
Solid door	6071 00	6071 01	6071 02	6071 03	6071 04	6071 05
Glass door	6071 50	6071 51	6071 52	6071 53	6071 54	6071 55

TYPE B DISTRIBUTION BOARDS 250 A TP & N – STANDARD

TP & N – STANDARD	Number of ways (triple pole)					
	4	6	8	12	16	24
Solid door	6071 10	6071 11	6071 12	6071 13	6071 14	6071 15
Glass door	6071 60	6071 61	6071 62	6071 63	6071 64	6071 65

TYPE B DISTRIBUTION BOARDS 125 A 1 TO 4 POLE – FLEXIBLE

1 TO 4 POLE – FLEXIBLE	Number of modules			
	24	36	48	72
Solid door	6071 06	6071 07	6071 08	6071 09
Glass door	6071 56	6071 57	6071 58	6071 59

TYPE B DISTRIBUTION BOARDS 250 A 1 TO 4 POLE – FLEXIBLE

1 TO 4 POLE – FLEXIBLE	Number of modules			
	24	36	48	72
Solid door	6071 16	6071 17	6071 18	6071 19
Glass door	6071 66	6071 67	6071 68	6071 69

INCOMING DEVICES AND KITS (125 A BOARDS)

Switch disconnecter 100 A 3P	0043 55 + 6072 00
Switch disconnecter 100 A 4P	0043 75 + 6072 00
Switch disconnecter 125 A 3P	0043 58 + 6072 00
Switch disconnecter 125 A 4P	0043 78 + 6072 00
MCCB 125 A 3P	0250 21 + 6072 01
MCCB 125 A 4P	0250 29 + 6072 02
MCCB 125 A 4P + earth leakage ⁽¹⁾	0250 29 + 0260 14 + 6072 03

INCOMING DEVICES AND KITS (250 A BOARDS)

Trip-free switch 250 A 3P	0252 98 + 6072 04
Trip-free switch 250 A 4P	0252 99 + 6072 05
MCCB 250 A 3P	0252 26 + 6072 04
MCCB 250 A 4P	0252 36 + 6072 05
MCCB 250 A 4P + earth leakage ⁽¹⁾	0252 36 + 0260 38 + 6072 06

(1) Boards fitted with incoming earth leakage modules require 200 mm additional cabling space provided by fitting cable boxes
Cat. No. 6071 72 (see p. 59)
Revised height dimensions available on p. 60

OUTGOING DEVICES (63 A MAX.) - DX-H / DX-D MCBs 6 kA / 10 kA BS EN 60898-1 12-5/25 kA BS EN 60947-2

Rating (A)	B curve		C curve		D curve	
	1P	3P	1P	3P	1P	3P
1	0066 91	0067 72	0068 52	0069 32	0065 75	0066 45
2	0066 92	0067 73	0068 53	0069 33	0065 76	0066 46
3	0066 93	0067 74	0068 54	0069 34	0065 77	0066 47
6	0066 95	0067 76	0068 56	0069 36	0065 79	0066 49
10	0066 97	0067 78	0068 58	0069 38	0065 81	0066 51
16	0067 00	0067 80	0068 60	0069 40	0065 83	0066 53
20	0067 01	0067 81	0068 61	0069 41	0065 84	0066 54
25	0067 02	0067 82	0068 62	0069 42	0065 85	0066 55
32	0067 03	0067 83	0068 63	0069 43	0065 86	0066 56
40	0067 04	0067 84	0068 64	0069 44	0065 87	0066 57
50	–	0067 85	0068 65	0069 45	0065 88	0066 58
63	0067 06	0067 86	0068 66	0069 46	0065 89	0066 59

OUTGOING DEVICES (63 A MAX.) - RCBOs SINGLE MODULE 10 kA BS EN 61009-1

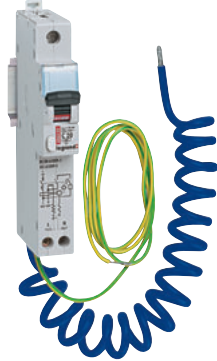
Rating (A)	C curve	
	1P	
10	6064 10	
16	6064 11	
20	6064 12	
25	6064 13	
32	6064 14	
45	6064 15	

Note :

All outgoing devices on this page (up to 63 A) fit both the standard TP & N and flexible MCB distribution boards

More devices fit the flexible board than the standard board, including some SP & N RCDs, and 4 pole MCBs (up to 63 A) shown on p. 83 and 79 respectively

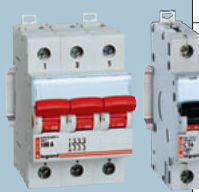
	Incoming devices	Outgoing devices
	Page	Page
Switch disconnectors 100-125 A	100	MCBs 10 kA 79
Trip-free switch 250 A	65/66	RCBOs 10 kA 84
MCCBs 125 A	64	
MCCBs 250 A	65/66	

type B distribution boards

standard 125 A and 250 A busbar



6071 03 open with plate removed

6071 54

6071 10



Dimensions (p. 60)

Conform to BS EN 60439-3

IP 40

RAL 7035

Maximum rating for outgoing devices : 63 A

Pack	Cat. Nos.	Type B 125 A TP & N - standard
		Busbar rating : 125 A Supplied with 3 pole outgoing connectors
		Solid door
		No. of TP ways
1	6071 00	4
1	6071 01	6
1	6071 02	8
1	6071 03	12
1	6071 04	16
1	6071 05	24
		Glass door
		No. of TP ways
1	6071 50	4
1	6071 51	6
1	6071 52	8
1	6071 53	12
1	6071 54	16
1	6071 55	24

Pack	Cat. Nos.	Type B 250 A TP & N - standard
		Busbar rating : 250 A Supplied with 3 pole outgoing connectors
		Solid door
		No. of TP ways
1	6071 10	4
1	6071 11	6
1	6071 12	8
1	6071 13	12
1	6071 14	16
1	6071 15	24
		Glass door
		No. of TP ways
1	6071 60	4
1	6071 61	6
1	6071 62	8
1	6071 63	12
1	6071 64	16
1	6071 65	24

Note :

Various other outgoing devices including a range of timers, contactors, control switches, indicator lights, transformers, buzzers, stairwell timers, etc. can be added to these boards. Many fit inside the board itself, others require the use of an extension box. See p. 100-127

type B distribution boards

flexible 125 A and 250 A busbar



6071 66 open with plate removed

6072 17



Dimensions (p. 60)

Conform to BS EN 60439-3

IP 40

RAL 7035

Maximum rating for outgoing devices : 63 A

Pack	Cat. Nos.	Type B 125 A 1 to 4 pole - flexible
		Busbar rating : 125 A Supplied without connectors, see below
		Solid door
		Max. No. of modules
1	6071 06	24
1	6071 07	36
1	6071 08	48
1	6071 09	72
		Glass door
		Max. No. of modules
1	6071 56	24
1	6071 57	36
1	6071 58	48
1	6071 59	72

Pack	Cat. Nos.	Type B 250 A 1 to 4 pole - flexible
		Busbar rating : 250 A Supplied without connectors, see below
		Solid door
		Max. No. of modules
1	6071 16	24
1	6071 17	36
1	6071 18	48
1	6071 19	72
		Glass door
		Max. No. of modules
1	6071 66	24
1	6071 67	36
1	6071 68	48
1	6071 69	72

Pack	Cat. Nos.	Connectors for flexible distribution boards
8	6072 10	Connector – L1 phase
8	6072 11	Connector – L2 phase
8	6072 12	Connector – L3 phase
8	6072 13	Connector – neutral
4	6072 14	Connector – double pole (L1 + neutral)
4	6072 15	Connector – double pole (L2 + neutral)
4	6072 16	Connector – double pole (L3 + neutral)
8	6072 17	Connector – triple pole
6	6072 18	Connector – four pole
8	6071 83	Connector – blank



type B distribution board accessories



Pack	Cat. Nos.	Incomer kits
1	6072 00	Kit for incomer 3P/4P MCB / switch disconnecter
1	6072 01	Kit for incomer MCCB 125 A 3P
1	6072 02	Kit for incomer MCCB 125 A 4P
1	6072 03	Kit for incomer MCCB 125 A 4P – earth leakage underneath
1	6072 04	Kit for incomer MCCB 250 A 3P + trip free switch
1	6072 05	Kit for incomer MCCB 250 A 4P + trip free switch
1	6072 06	Kit for incomer MCCB 250 A 4P – earth leakage underneath

Direct connection		
For direct incoming cable connection		
1	6071 30	Terminal block 125 A
1	6071 31	Terminal block 250 A

Extension boxes - height 200 mm		
1	6071 70	Box for rail products (max. 15 modules)
1	6071 72	Cable box top/bottom

Gland plates		
1	6071 75	Gland plate – plain
1	6071 76	Gland plate – with knockouts

Neutral and earth bars			
1	0048 42	Neutral bar	Outgoing capacity: 8 x 1.5 to 16 mm ² Terminal length (mm): 75
1	0048 32	Clean earth	Outgoing capacity: 8 x 1.5 to 16 mm ² Terminal length (mm): 75

Locking accessories		
1	6071 80	Handle key lock Cylinder lock
1	6071 81	Handle for padlock Padlock not supplied See Cat. No. 0044 43 below
2	0044 42	Locking device Attachment for Ø 5 mm and Ø 6 mm padlocks to fit DX-H and DX-D
1/3	0044 43	Padlock Ø 5 mm



Pack	Cat. Nos.	Insulated covers, labels and spacers
1	6071 82	Blank MCB 10 module plate for inner front cover
5	0049 83	Insulated covers for 4 connector pins Not required if Cat. No. 0044 41 module is used
Spacing elements		
10	0044 40	0.5 module
5	0044 41	1 module
Self-adhesive label holder		
10	0049 96	Width : 16 mm Width available for marking : 12 mm Length 430 mm (24 modules)

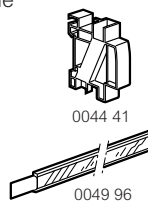

Meter packs		
Metering unit for type B distribution boards Mounts directly onto the distribution board and utilises the existing gland plate Supplied as a pre-wired unit complete with multi-function digital meter, see p. 86		
With multi-function energy meter		
1	6071 20	125 A meter pack
1	6071 21	250 A meter pack
With multi-function energy meter and Modbus connectivity		
1	6071 22	125 A meter pack
1	6071 23	250 A meter pack

	Incoming devices		Outgoing devices	
		Page		Page
	Switch disconnectors		MCCBs 10 kA	79
	100-125 A	100	RCBOs 10 kA	84
	Trip-free switch 250 A	65/66		
	MCCBs 125 A	64		
	MCCBs 250 A	65/66		

type B distribution boards

■ Dimensions (mm)

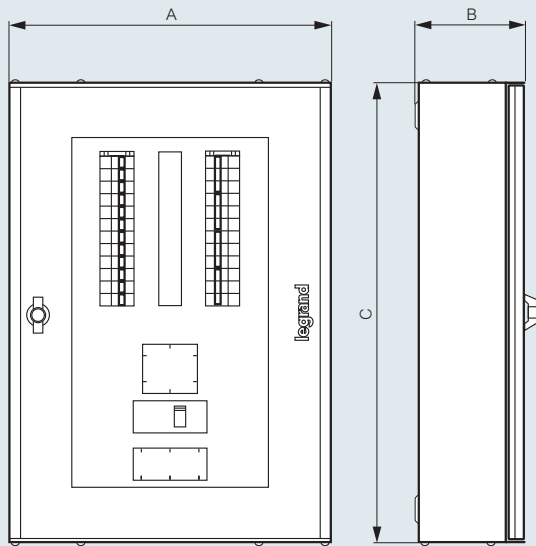

125 A TP & N standard board (solid or glass door)

No. of ways	A	B	C ⁽¹⁾
4	450	150	555
6	450	150	605
8	450	150	655
12	450	150	805
16	450	150	855
24	450	150	1205

250 A TP & N standard board (solid or glass door)

No. of ways	A	B	C ⁽¹⁾
4	450	150	655
6	450	150	705
8	450	150	755
12	450	150	855
16	450	150	955
24	450	150	1205

125 A 1P - 4P flexible board (solid or glass door)

No. of ways	A	B	C ⁽¹⁾
24	450	150	655
36	450	150	805
48	450	150	855
72	450	150	1205

250 A 1P - 4P flexible board (solid or glass door)

No. of ways	A	B	C ⁽¹⁾
24	450	150	755
36	450	150	855
48	450	150	955
72	450	150	1205

(1) Boards with 4 pole MCCB incomers fitted with earth leakage modules require the extra cabling space provided by bottom mounted cable boxes, Cat. No. 6071 72, see p. 59 (For height with cable box add 200 mm to dimension C)

type A distribution boards



6022 53



Dimensions (opposite)

Conform to BS EN 60439-3

Enclosure 1.2 mm thick steel with polyester powder coated grey RAL 7035

Pack	Cat. Nos.	Metal with 100 A switch disconnector
		Lockable with Ø5 mm padlock (not supplied), see p. 60
		6 to 18 way
		No. of SP outgoing ways
1	6022 51	6
1	6022 52	10
1	6022 53	14
1	6022 54	18

Accessory

10	0016 65	Grey blanking plate RAL 7035 18 module, blanking strip
----	---------	--

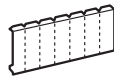

type A distribution boards

■ Dimensions (mm)

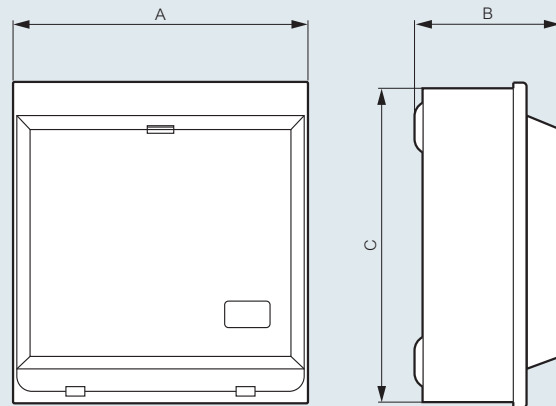

Metal with 100 A switch disconnector

No. of ways	A	B	C
6	260	120	235
10	332	120	235
14	377	120	235
18	449	120	235



Other configurations available to special order

Contact us on +44 (0) 845 605 4333

DPX[®] MCCBs

selection chart

TYPE OF CASE AND SIZE

	DPX 125	DPX 125	DPX 250 ER
			

TYPE OF MCCB

	DPX-E	DPX-E (16 kA)	DPX (25 kA)	DPX (36 kA)	DPX (36 kA)
Number of poles	1	3-4			3-4
Nominal rating I _n (A)	16-125	16-125			25-250

ELECTRICAL CHARACTERISTICS CONFORMING TO EN 60947-2

Rated operating voltage U _e (50-60 Hz) ~	230	500			500
Rated operating voltage U _e = (V)	–	250			250
Rated insulation voltage U _i ~ (V)	290	500			500
Rated impulse withstand voltage U _{imp} (kV)	6	6			6
Category of use	A	A			A
Ultimate breaking capacity (kA) 230 V~	16	22	35	40	50
	400 V~	–	16	25	36
	440 V~	–	10	18	25
	480/500 V~	–	8	12	12
	600 V~	–	–	–	–
	690 V~	–	–	–	–
250 V=	–	16	25	30	36
Standard breaking capacity I _{cs} (% I _{cu})	50	100	50	75	75
Rated closing capacity on short-circuit (400 V~)	32	32	52-5	75-6	75-6
Rated short-time withstand current I _{cw} (kA)	–	–			–
Endurance (o.c. cycle)	mechanical	25 500			20 000
	electrical	8 500			8 000
Isolation capability	•	•			•

TYPE OF PROTECTION

Thermal-magnetic release	•	•			•
Earth leakage modules	underneath	•			•
	side by side	•			•

DIMENSIONS AND WEIGHTS

Dimensions (L x H x D) (mm)	single pole	25 x 120 x 74	–		–
	triple pole		75-6 x 120 x 74		90 x 176 x 74
	four pole		101 x 120 x 74		120 x 176 x 74
Weight (kg)	triple pole		1		1-6
	four pole		1-2		2-1
Allen key size (mm) A/F (screw size)		4	4		6 (M8)

TYPE OF CASE AND SIZE
DPX 250

DPX 630

DPX 1250

TYPE OF MCCB
DPX
DPX-H
DPX
DPX-H
DPX
DPX-H

 3-4
100-250

 3-4
250-630

 3-4
500-800

ELECTRICAL CHARACTERISTICS CONFORMING TO EN 60947-2

690

690

690

250

250

250

690

690

690

8

8

8

A

A

A

60

100

60

100

80

100

36

70

36

70

50

70

30

60

30

60

45

65

25

40

25

40

35

45

20

25

20

25

25

35

16

20

16

20

25

25

36

40

-

-

50

50

100

75

100

75

100

75

75-6

154

75-6

154

105

154

-

-

-

20 000

15 000

10 000

8 000

5 000

4 000

•

•

•

TYPE OF PROTECTION

•

•

•

•

•

•

DIMENSIONS AND WEIGHTS

-

-

-

105 x 200 x 105

140 x 260 x 105

210 x 320 x 140

140 x 200 x 105

183 x 260 x 105

280 x 320 x 140

2-5

5-5

12·2 ≤ 800 > 18

3-7

6-4

15·1 ≤ 800 > 23·4

6 (M8)

8 (M10)

10 (M12)

DPX® 125

MCCBs from 16 to 125 A and trip-free switches



0250 18



0250 45



0250 99

DPX® 125

earth leakage module and accessories



0260 14



0262 08





Selectivity and co-ordination (p. 75-76)
Electrical characteristics (p. 70)
Dimensions (p. 77)
Auxiliaries (p. 68)

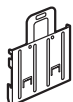

Dimensions (p. 77)

Pack	Cat. Nos.		DPX-E 125 and DPX 125 MCCBs
			Conform to BS EN 60947-2 Supplied complete with : - cage terminals 70 mm ² max. - terminal shields Fixed version - front terminals Max. rated voltage 500 V \sim - 50/60 Hz 230 V \sim for single pole Thermal release adjustable from 0.7 to 1 In 3 pole breakers supplied with 2 insulating shields 4 pole breakers supplied with 3 insulating shields Fixed for single pole Fixed magnetic at 10 In in factory Can be mounted on rail  with fixing plate Cat. No. 0262 08
			DPX-E 125 - 16 kA Breaking capacity Icu : 16 kA (230 V \sim)
	1 P		In
1	0250 00		16 A
1	0250 01		20 A
1	0250 02		25 A
1	0250 03		32 A
1	0250 04		40 A
1	0250 05		50 A
1	0250 06		63 A
1	0250 07		80 A
1	0250 08		100 A
1	0250 09		125 A
			Breaking capacity Icu : 16 kA (400 V \sim)
	3 P	4 P	In
1	0250 16	0250 24	16 A
1	0250 17	0250 25	25 A
1	0250 18	0250 26	40 A
1	0250 19	0250 27	63 A
1	0250 20	0250 28	100 A
1	0250 21	0250 29	125 A
			DPX 125 - 25 kA Breaking capacity Icu : 25 kA (400 V \sim)
			In
1	0250 36	0250 44	16 A
1	0250 37	0250 45	25 A
1	0250 38	0250 46	40 A
1	0250 39	0250 47	63 A
1	0250 40	0250 48	100 A
1	0250 41	0250 49	125 A
			DPX 125 - 36 kA Breaking capacity Icu : 36 kA (400 V \sim)
			In
1	0250 50	0250 58	16 A
1	0250 51	0250 59	25 A
1	0250 52	0250 60	40 A
1	0250 53	0250 61	63 A
1	0250 54	0250 62	100 A
1	0250 55	0250 63	125 A

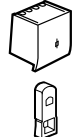
Pack	Cat. Nos.		Electronic earth leakage module
			Can be fitted directly on to DPX-E 125, DPX 125 and DPX-I 125 Operating voltage : 230 to 500 V \sim Adjustable and sealable sensitivity : 0.03 - 0.3 - 1 - 3 A Adjustable and sealable time delay : 0 - 0.3 - 1 - 3 s Equipped with : • Test and reset push button • Isolator switch for electronic circuits (for commissioning tests) to open the DPX automatically
			Mounted underneath
1	4 P		In
		0260 14	125 A
			Accessories
			MCCBs are supplied with insulating shields (2 per 3P, 3 per 4P). Additional shields are also available
			Fixing plate For fixing devices on rail For DPX 125 or downstream earth leakage module
1		0262 08	
			Insulating shields Used to isolate the connections between each pole Set of 3 insulating shields
1		0262 07	
	3 P	4 P	Sealable terminal shields
1	0262 05	0262 06	Set of 2 terminal shields
			Padlocking accessory For locking in "OFF" position
1		0262 00	

DPX-I 125 trip-free switches

Conform to BS EN 60947-3
Category of use AC 23 A
Max. rated voltage 500 V \sim - 50/60 Hz
Without thermal-magnetic release

Pack	3 P	4 P	In
1	0250 98	0250 99	125 A

DPX® 250 ER

MCCBs from 25 to 250 A and trip-free switches



0252 36



0252 99

DPX® 250 ER

earth leakage module and accessories



0260 38



0262 00



Selectivity and co-ordination (p. 75-76)
Electrical characteristics (p. 71)
Dimensions (p. 77)
Auxiliaries (p. 68)



Dimensions (p. 77)

Pack	Cat. Nos.		DPX 250 ER MCCBs
			Conform to BS EN 60947-2 Fixed version - front terminals Max. rated voltage 500 V \sim - 50/60 Hz 230 V \sim for single pole Thermal release adjustable from 0.64 to 1 In 3 pole breakers supplied with 2 insulating shields 4 pole breakers supplied with 3 insulating shields Magnetic fixed at 10 In Can be mounted on rail with fixing plate Cat. No. 0262 09
			DPX 250 ER - 25 kA Breaking capacity Icu : 25 kA (400 V \sim)
	3 P	4 P	In
1	0252 01	0252 11	25 A
1	0252 02	0252 12	40 A
1	0252 03	0252 13	63 A
1	0252 04	0252 14	100 A
1	0252 05	0252 15	160 A
1	0252 06	0252 16	250 A
			DPX 250 ER - 36 kA Breaking capacity Icu : 36 kA (400 V \sim)
	3 P	4 P	In
1		0252 31	25 A
1	0252 22	0252 32	40 A
1	0252 23	0252 33	63 A
1	0252 24	0252 34	100 A
1	0252 25	0252 35	160 A
1	0252 30	0252 37	200 A
1	0252 26	0252 36	250 A
			DPX-I 250 ER trip-free switches
			Conform to BS EN 60947-3 Category of use AC 23 A
	3 P	4 P	In
1	0252 96	0252 97	160 A
1	0252 98	0252 99	250 A

Pack	Cat. Nos.		Electronic earth leakage module
			Conform to BS EN 60947-2 and BS EN 60947-3 Thermal release adjustable from 0.64 to 1 In Can be fitted directly on to DPX 250 ER, DPX-I 250 ER and trip-free switches Operating voltage : 230 to 500 V \sim Adjustable and sealable sensitivity : 0.03 - 0.3 - 1 - 3 A Adjustable tripping : 0 - 0.3 - 1 - 3 s Switch for mechanical tests on operation and insulation of the device in case of installation insulation test Nominal operating voltage : 230 - 500 V \sim
			Mounted underneath In 250 A
1	4 P	0260 38	
			Accessories
			MCCBs are supplied with insulating shields (2 per 3P, 3 per 4P). Additional shields are also available
			Fixing plate For fixing devices on rail For DPX 160, DPX 250 ER or downstream earth leakage module
1	0262 09		
			Insulating shields Used to isolate the connections between each pole Set of 3 insulating shields
1	0262 07		
	3 P	4 P	Sealable terminal shields
1	0262 85	0262 86	Set of 2 terminal shields
			Connection terminals (cage) Set of 4 terminals for cables without lugs - 185 mm ² max. (rigid) or 150 mm ² max. (flexible)
1	0262 88		
			Spreaders For increasing the distance between each pole to be connected Set of incoming or outgoing spreaders
1	3 P	4 P	
1	0262 90	0262 91	
			Padlocking accessory For locking in "OFF" position
1	0262 00		

DPX® 250

MCCBs from 100 to 250 A and trip-free switches



0253 49



0253 73

DPX® 250

earth leakage modules and accessories



0260 55



Selectivity and co-ordination (p. 75-76)
Electrical characteristics (p. 72)
Dimensions (p. 77)
Auxiliaries (p. 68)



Dimensions (p. 77)

Pack	Cat. Nos.		DPX 250 MCCBs
			Conform to BS EN 60947-2 Thermal release adjustable from 0.64 to 1 In 3 pole breakers supplied with 2 insulating shields 4 pole breakers supplied with 3 insulating shields Adjustable magnetic from 3.5 to 10 In Sealable thermal and magnetic releases Supplied with terminal shields
			DPX 250 - 36 kA Breaking capacity Icu : 36 kA (400 V~)
	3 P	4 P	In
1	0253 30	0253 47	100 A
1	0253 31	0253 48	160 A
1	0253 32	0253 49	250 A
			DPX-H 250 - 70 kA Breaking capacity Icu : 70 kA (400 V~)
	3 P	4 P	In
1	0253 54	0253 71	100 A
1	0253 55	0253 72	160 A
1	0253 56	0253 73	250 A

Pack	Cat. Nos.		DPX-I 250 trip-free switches
			Conform to BS EN 60947-3 Category of use AC 23 A Fixed version - front terminals Without thermal-magnetic release
	3 P	4 P	In
1	0253 98	0253 99	250 A

Pack	Cat. Nos.		Electronic earth leakage modules
			Can be fitted directly on to MCCBs and trip-free switches Adjustable and sealable sensitivity : 0.03 - 0.3 - 1 - 3 A Adjustable tripping : 0 - 0.3 - 1 - 3 s Test push button - Reset push button Integrated remote earth fault signalling contact
			Mounted underneath Rated operating voltage : 230 - 500 V~
	3 P	4 P	In
1	0260 54	0260 55	250 A
			Accessories MCCBs are supplied with insulating shields (2 per 3P, 3 per 4P). Additional shields are also available
1			Insulating shields Used to isolate the connections between each pole Set of 3 insulating shields
1	3 P	4 P	Sealable terminal shields Set of 2 terminal shields
1			Connection terminals (cage) Sets of 4 terminals for bare cables 185 mm ² max. (rigid) or 150 mm ² max. (flexible)
1			Padlocking accessory For locking in "OFF" position

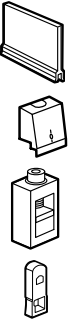

DPX® 630

MCCBs from 250 to 630 A and trip-free switches



0255 40



0255 58

DPX® 630

earth leakage modules and accessories



0260 61



0262 51



0262 40



Selectivity and co-ordination (p. 75-76)
Electrical characteristics (p. 73)
Dimensions (p. 78)
Auxiliaries (p. 68)



Dimensions (p. 78)

Pack	Cat. Nos.		DPX 630 MCCBs
			Conform to BS EN 60947-2 Fixed version - front terminals Max. rated voltage 690 V~ - 50/60 Hz 230 V~ for single pole Thermal release adjustable from 0.8 to 1 In 3 pole breakers supplied with 2 insulating shields 4 pole breakers supplied with 3 insulating shields Magnetic release adjustable from 5 to 10 In Supplied with incoming terminals mounted
			DPX 630 - 36 kA Breaking capacity Icu : 36 kA (400 V~)
	3 P	4 P	In
1	0255 21	0255 36	250 A
1	0255 22	0255 37	320 A
1	0255 23	0255 38	400 A
1	0255 24	0255 40	630 A
			DPX-H 630 - 70 kA Breaking capacity Icu : 70 kA (400 V~)
	3 P	4 P	In
1	0255 41	0255 56	250 A
1	0255 42	0255 57	320 A
1	0255 43	0255 58	400 A
1	0255 44	0255 60	630 A

Pack	Cat. Nos.		DPX-I 630 trip-free switches
			Conform to BS EN 60947-3 Category of use AC 23 A
	3 P	4 P	In
1	0255 96	0255 97	400 A
1	0255 88	0255 89	630 A

Pack	Cat. Nos.		Electronic earth leakage modules
			Can be fitted directly on to standard MCCBs and trip-free switches Adjustable and sealable sensitivity : 0.03 - 0.3 - 1 - 3 A Adjustable tripping : 0 - 0.3 - 1 - 3 s Test push button - Reset push button Integrated remote earth fault signalling contact Rated operating voltage : 230 - 500 V~
			Mounted underneath
			For DPX 630 (up to In 400 A)
			For DPX 630 (In 630 A)
	3 P	4 P	
1	0260 60	0260 61	
1	0260 64	0260 65	

Pack	Cat. Nos.		Accessories
			MCCBs are supplied with insulating shields (2 per 3P, 3 per 4P). Additional shields are also available
			Insulating shields Used to isolate the connections between each pole Set of 3 insulating shields
1		0262 30	
	3 P	4 P	
1	0262 44	0262 45	Sealable terminal shields Set of 2 terminal shields
			Connection terminals (cage) Set of 4 terminals for cables, 300 mm ² max. (rigid) or 240 mm ² max. (flexible)
1		0262 50	
			High-capacity terminals Set of 4 for 2 x 240 mm ² (rigid) or 2 x 185 mm ² flexible
1		0262 51	
			Padlocking accessory For locking in "OFF" position
1		0262 40	

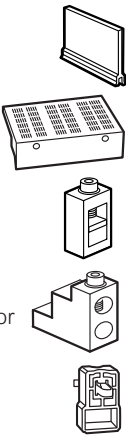

DPX® 1 250

MCCBs from 500 to 800 A, trip-free switches and accessories

control and signalling auxiliaries

for all DPX devices



0258 02



0262 65



0262 70



0262 60

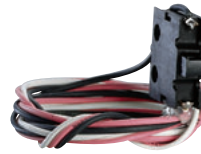

0261 60



0261 83

Selectivity and co-ordination (p. 75-76)
Electrical characteristics (p. 74)
Dimensions (p. 78)
Auxiliaries (opposite)

Pack	Cat. Nos.		DPX 1 250 MCCBs
			Conform to BS EN 60947-2 Fixed version - front terminals Max. rated voltage 690 V \sim - 50/60 Hz Thermal release adjustable from 0.8 to 1 In 3 pole breakers supplied with 2 insulating shields 4 pole breakers supplied with 3 insulating shields Magnetic release adjustable from 5 to 10 In from 500 to 800 A Magnetic release adjustable from 3 to 6 In from 1 000 to 1 250 A Supplied with incoming terminals mounted
			DPX 1 250 - 50 kA Breaking capacity Icu : 50 kA (400 V \sim)
1	3 P	4 P ⁽¹⁾	In
1	0258 00	0258 07	500 A
1	0258 01	0258 08	630 A
1	0258 02	0258 09	800 A
			DPX-H 1 250 - 70 kA Breaking capacity Icu : 70 kA (400 V \sim)
			In
1	3 P	4 P ⁽¹⁾	500 A
1	0258 14	0258 22	630 A
1	0258 15	0258 23	800 A

Pack	Cat. Nos.		DPX-I 1 250 trip-free switches
			Conform to BS EN 60947-3 Category of use AC 23 A Without thermal-magnetic release
			In
1	3 P	4 P	630 A
1	0257 92	0257 93	800 A
1	0257 94	0257 95	

Pack	Cat. Nos.		Accessories
			MCCBs are supplied with insulating shields (2 per 3P, 3 per 4P). Additional shields are also available
1			Insulating shields Used to isolate the connections between each pole Set of 3 insulation shields
1	3 P	4 P	Sealable terminal shields Set of 2 short terminal shields
1	0262 64	0262 65	
1			Connection terminals For connecting bare cables without lugs Set of 1 terminal 2 x 240 mm ² (rigid) or 2 x 185 mm ² (flexible)
1	0262 69		
1	0262 70		Set of 1 high-capacity terminal 4 x 240 mm ² for rigid cable 4 x 185 mm ² for flexible cable
1	0262 67		Extended front terminals Short terminals
1	0262 68		Long terminals
1	0262 60		Padlocking accessory For handle, locking in "OFF" position



Pack	Cat. Nos.		Auxiliary contact or fault signal
			For signalling the state of the contacts or opening of the MCCB on a fault For MCCBs and trip-free switches from 16 to 800 A Changeover switch 3 A - 240 V
1		0261 60	
			Shunt trips Allow remote tripping of a DPX device For MCCBs and trip-free switches from 16 to 800 A
			Shunt inrush power 300 VA
1		0261 64	Coil voltage 24 V \sim and \equiv
1		0261 65	Coil voltage 48 V \sim and \equiv
1		0261 66	Coil voltage 110 V \sim and \equiv
1		0261 67	Coil voltage 230 V \sim and \equiv
1		0261 68	Coil voltage 400 V \sim and \equiv
			Undervoltage releases Allow remote tripping of a DPX device For MCCBs and trip-free switches from 16 to 800 A
			Undervoltage power consumption 5 VA
			For DPX 125
1		0261 70	0261 80
1		0261 71	0261 81
1		0261 72	0261 82
1		0261 76	0261 86
1		0261 73	0261 83
1		0261 74	0261 84
			For all DPX 250 to 1250
			Coil voltage 24 V \sim
			Coil voltage 24 V \sim
			Coil voltage 48 V \sim
			Coil voltage 110 V \sim
			Coil voltage 230 V \sim
			Coil voltage 400 V \sim

(1) 3 P + N (Neutral on left - not protected)

technical information

key to characteristic curves

■ Characteristic curves

The graphs on the following pages detail the characteristic curves of each circuit breaking device

Complying with isolation requirements, the units are provided with fully visible contact indication and a lock-off facility

■ Time/current characteristics : thermal-magnetic

Reference ambient temperature 40 °C (DPX)

- I = actual current
 - I_m = short-circuit operating time
 - I_r = operating current
 - 1 = thermal release from cold
 - 2 = thermal release from hot
- Tolerance of magnetic release ±20 %

■ I²t/I_{cc} characteristics

- I_{cc} = prospective symmetrical short-circuit current (mms value - A)
- I²t = specific let through energy (A²s)

■ Limiting characteristics

- I_{cc} = prospective symmetrical short-circuit current (mms value - A)
- I_p = maximum peak value of current
- = maximum peak values of short-circuit current corresponding to power factors indicated above
- = maximum peak values of actual short-circuit current

■ Time/current characteristics : earth fault protection

- I_n = residual operating current (sensitivity)
- t = operating time

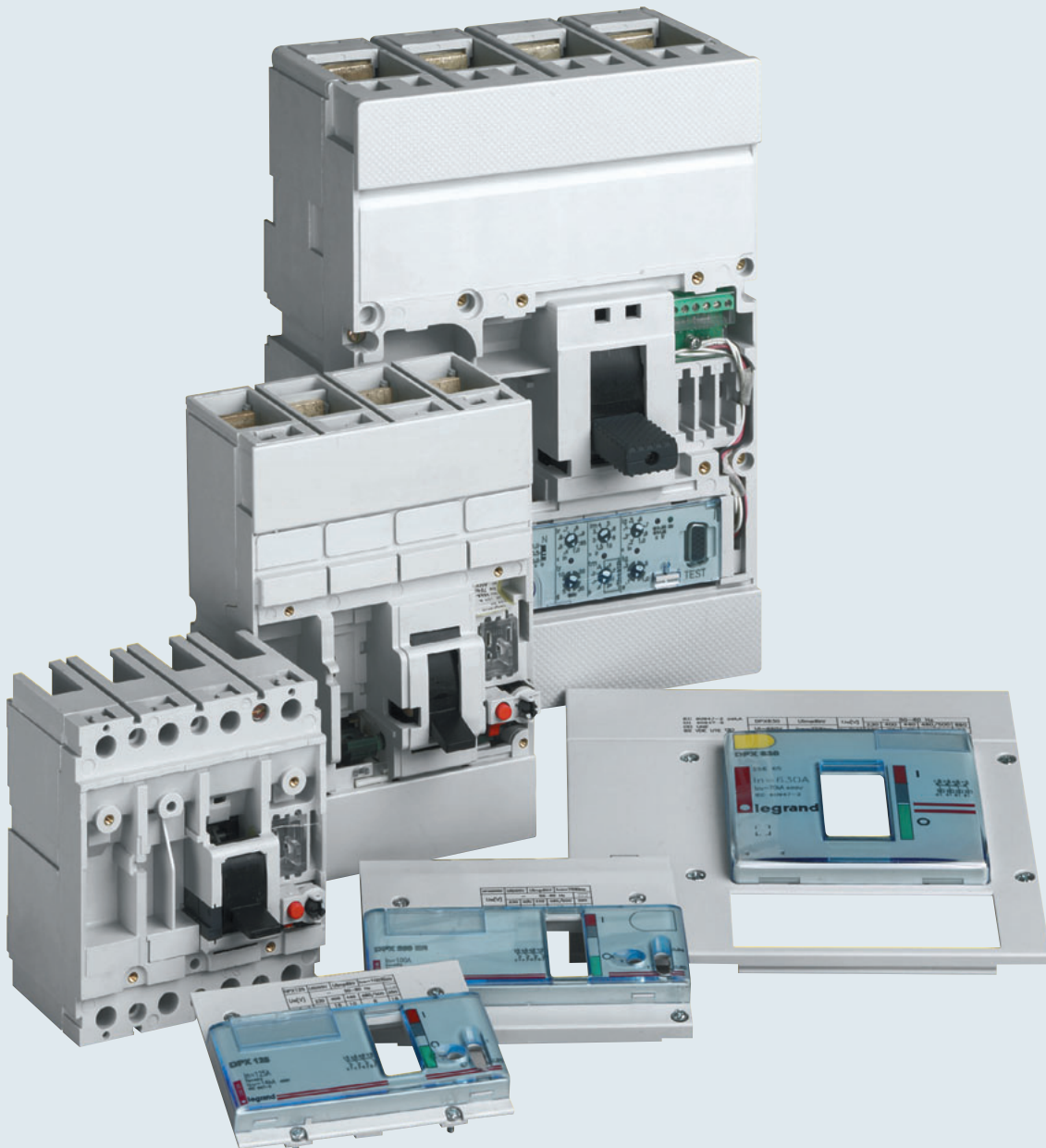

Electrical characteristics

Maximum nominal operating function	500 V~ - 250 V=
Nominal frequency	50/60 Hz
Category of use	A
Thermal adjustment	0.7 to 1 In
Maximum permitted cross sections for integral cage terminals	stranded cables : 70 mm ² flexible cables : 50 mm ² copper bar (width) : 12 mm

Nominal breaking capacity (kA) (BS EN 60947-2)

Ue	DPX 125 25 kA		DPX 125 36 kA	
	Icu (kA)	Ics (%Icu)	Icu (kA)	Ics (%Icu)
400 V~	25	50	36	75
230 V~	35	50	40	75

Tripping curves

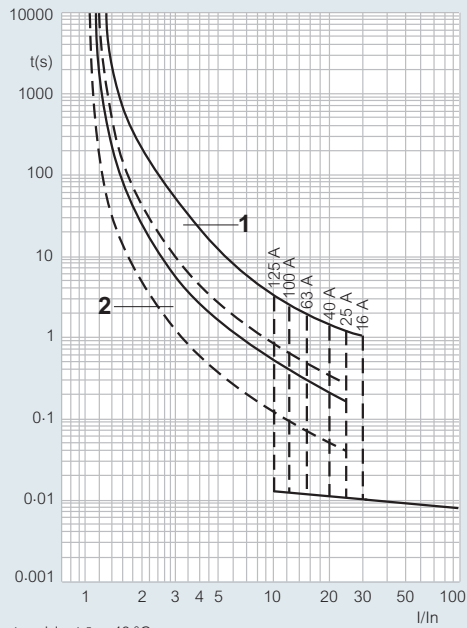

at ambient $\theta = 40^\circ\text{C}$
 I = actual current
 I_r = max. adjustment current of thermal release
 ① = thermal release zone when cold
 ② = thermal release zone when hot (in steady state)

Thermal stress limitation curves

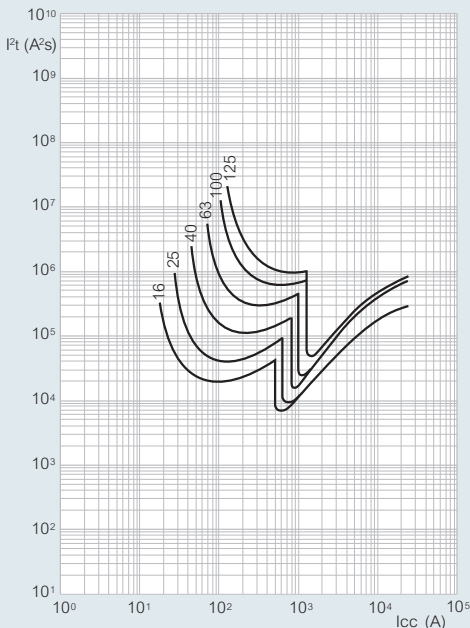

I_{cc} = prospective short-circuit symmetrical current (rms values in A)
 I^2t = limited thermal stress (in A²s)

Nominal current (In) at 40 °C (A) for DPX 125

In (A)	16	25	40	63	100	125
Phase	16	25	40	63	100	125
N	16	25	40	63	100	125
N/2	-	-	-	-	63	63

Fixed magnetic threshold (Im) (A)⁽¹⁾ for DPX 125

In (A)	16	25	40	63	100	125
Phase	480	625	800	950	1250	1250
N	480	625	800	950	950	950

(1) Trip current for 50/60 Hz
 For direct current, multiply by 1.5

Current limitation curves

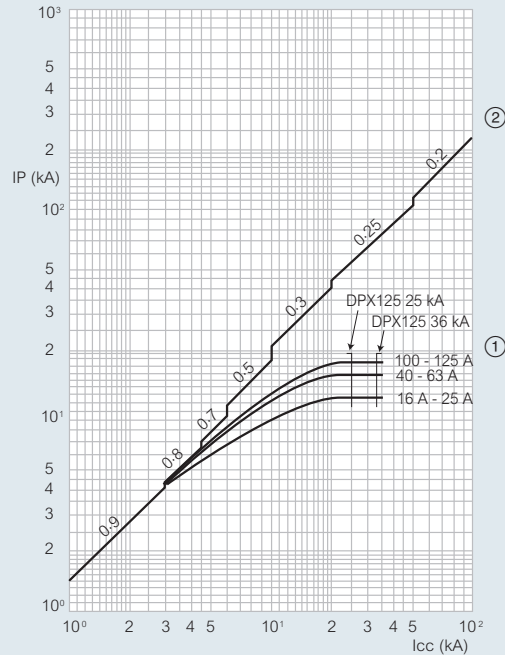

I_{cc} = prospective short-circuit symmetrical current (rms values in kA)
 I_P = maximum peak value (kA)
 ① = current, max. peak, short-circuit rms
 ② = current, unlimited peak (max.), corresponding to power factors shown above (0.15 to 0.9)

Differential tripping curves

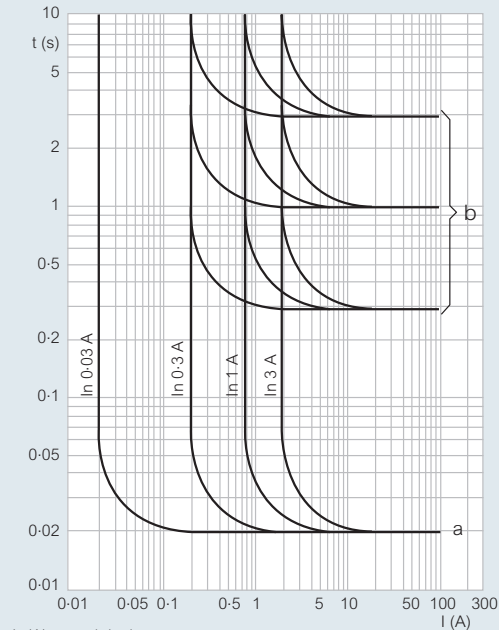

I_{Δ} (A) = earth leakage current
 $I_{\Delta n}$ = nominal earth leakage current
 a = instantaneous tripping point
 b = 3 possible delay settings (0.3, 1 and 3 seconds)

DPX® 250 ER

Electrical characteristics

Maximum nominal operating function	500 V~ - 250 V=
Nominal frequency	50/60 Hz
Category of use	A
Thermal adjustment	0.64 to 1 I _n
Maximum permitted cross sections via optional cage terminals (set of 4 Cat. No. 0262 88 see p. 65)	stranded cables : 185 mm ² flexible cables : 150 mm ² copper bar (width) : 22 mm (M8)

Nominal breaking capacity (kA) (BS EN 60947-2)

U _e	DPX 250 ER 25 kA	
	I _{cu} (kA)	I _{cs} (%I _{cu})
400 V~	25	100
230 V~	40	100

Tripping curves

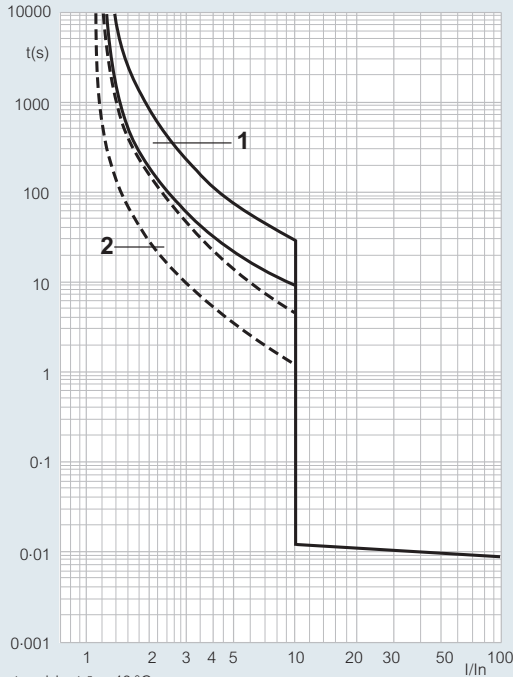

at ambient $\theta = 40^\circ\text{C}$
 I = actual current
 I_r = max. adjustment current of thermal release
 ① = thermal release zone when cold
 ② = thermal release zone when hot (in steady state)

Thermal stress limitation curves

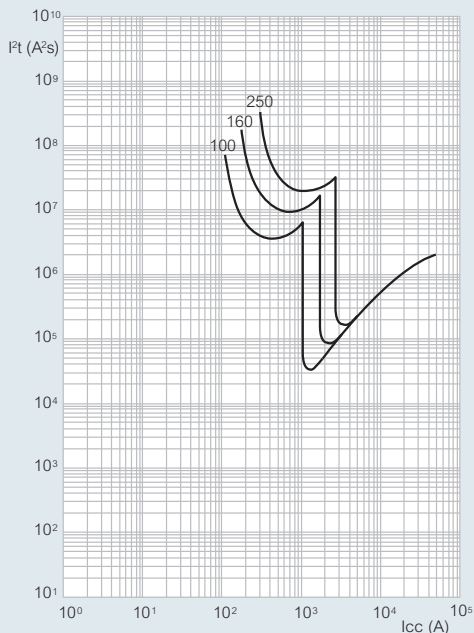

I_{cc} = prospective short-circuit symmetrical current (rms values in A)
 I^2t = limited thermal stress (in A²s)

Nominal current (I_n) at 40 °C (A) for DPX 250 ER

I _n (A)	100	160	250
Phase	100	160	250
N	100	160	250
N/2	-	100	160

Fixed magnetic threshold (I_m) (A) for DPX 250 ER

I _n (A)	100	160	250
Phase	1 000	1 600	2 500
N	1 000	1 600	2 500
N/2	-	1 000	1 600

Current limitation curves

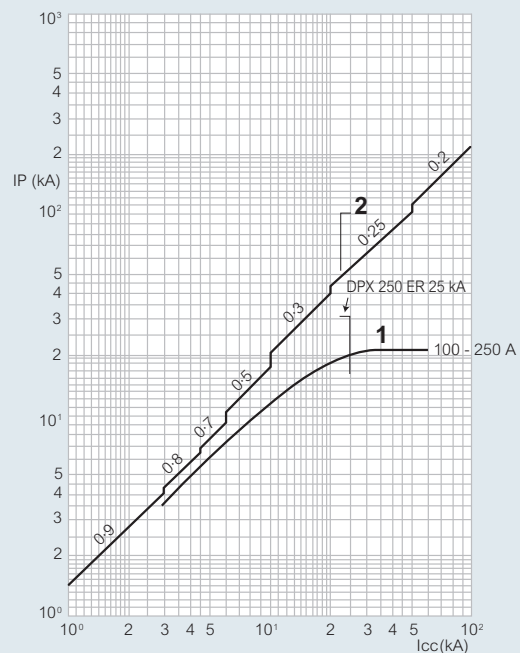

I_{cc} = prospective short-circuit symmetrical current (rms values in kA)
 I_P = maximum peak value (kA)
 ① = current, max. peak, short-circuit rms
 ② = current, unlimited peak (max.), corresponding to power factors shown above (0.2 to 0.9)

Differential tripping curves

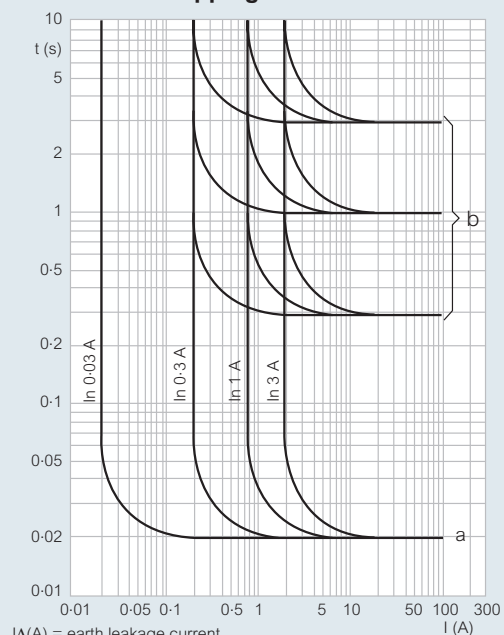

I Δ (A) = earth leakage current
 I_n = nominal earth leakage current
 a = instantaneous tripping point
 b = 3 possible delay settings (0.3, 1 and 3 seconds)

Electrical characteristics

Maximum nominal operating function	690 V~ - 250 V=
Nominal frequency	50/60 Hz
Category of use	A
Thermal adjustment	0.64 to 1 In
Magnetic release	3.5 to 10 In
Maximum permitted cross sections via optional cage terminals (set of 4 Cat. No. 0262 35 see p. 66)	stranded cables : 185 mm ² flexible cables : 150 mm ² copper bar (width) : 25 mm (M8)

Nominal breaking capacity (kA) (BS EN 60947-2)

Ue	DPX 250 36 kA		DPX-H 250 70 kA	
	Icu (kA)	Ics (%Icu)	Icu (kA)	Ics (%Icu)
400 V~	36	100	70	75
230 V~	60	100	100	75

Tripping curves

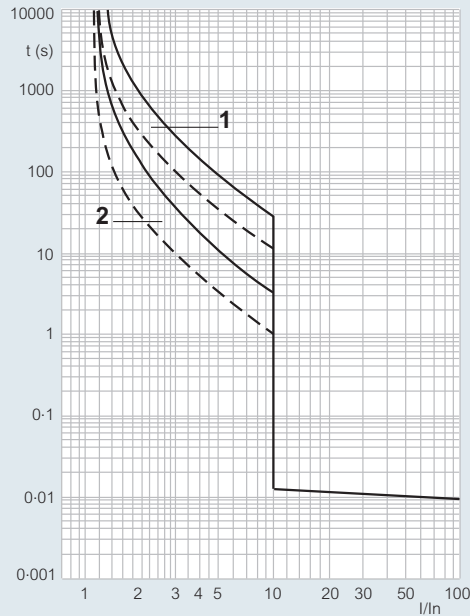

at ambient $\theta = 40^\circ\text{C}$
 I = actual current
 I_r = max. adjustment current of thermal release
 ① = thermal release zone when cold
 ② = thermal release zone when hot (in steady state)

Thermal stress limitation curves

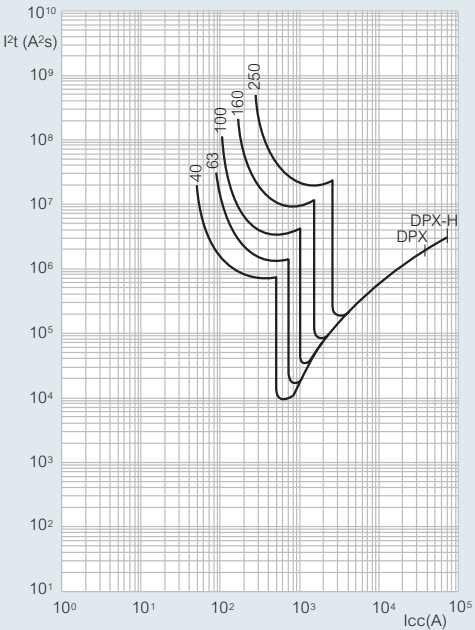

I_{cc} = prospective short-circuit symmetrical current (rms values in A)
 I^2t = limited thermal stress (in A²s)

Nominal current (In) at 40 °C (A) for DPX 250

In (A)	40	63	100	160	250
Phase	40	63	100	160	250
N	40	63	100	160	250
N/2	40	63	63	100	160

Fixed magnetic threshold (Im) (A) for DPX 250

In (A)	40	63	100	160	250
Phase	140-400	220-630	350-1 000	560-1 600	900-2 500
N	140-400	220-630	220-630	350-1 000	560-1 600

Current limitation curves

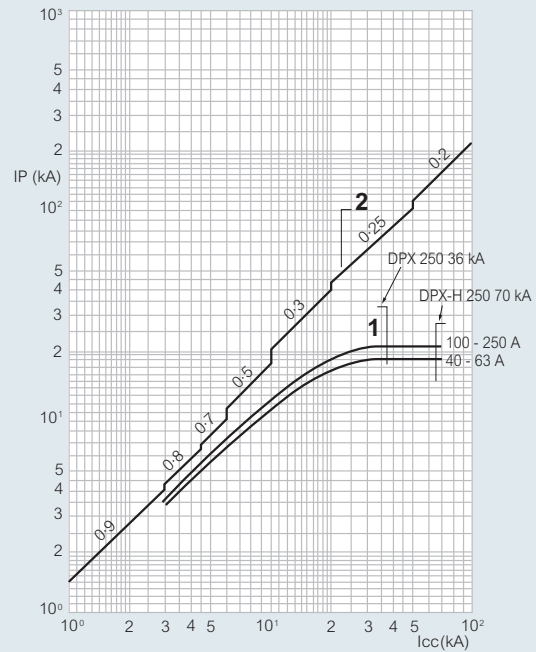

I_{cc} = prospective short-circuit symmetrical current (rms values in kA)
 I_P = maximum peak value (kA)
 ① = current, max. peak, short-circuit rms
 ② = current, unlimited peak (max.), corresponding to power factors shown above (0.2 to 0.9)

Differential tripping curves

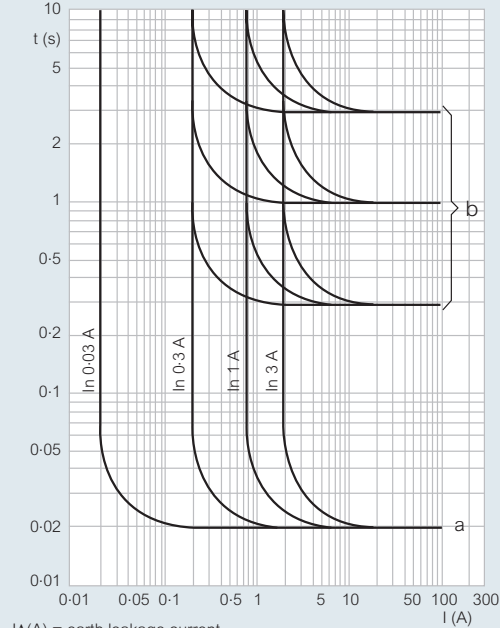

$I_{\Delta}(A)$ = earth leakage current
 $I_{\Delta n}$ = nominal earth leakage current
 a = instantaneous tripping point
 b = 3 possible delay settings (0.3, 1 and 3 seconds)

DPX® 630

Electrical characteristics

Maximum nominal operating function	690 V~
Nominal frequency	50/60 Hz
Category of use	A
Thermal adjustment	0.8 to 1 In
Magnetic release	0.5 to 10 In
Maximum permitted cross sections : - via optional cage terminals (set of 4 Cat. No. 0262 50 see p. 67) - via optional high capacity screw terminals (set of 4 Cat. No. 0262 51 see p. 67)	stranded cables : 300 mm ² (or 2 x 240 mm ²) flexible cables : 240 mm ² (or 2 x 185 mm ²) copper bar (width) : 32 mm (M10)

Tripping curves

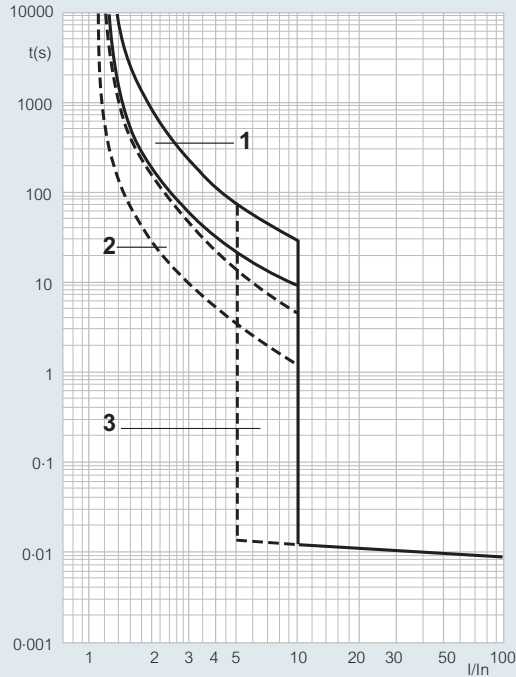

at ambient $\theta = 40^\circ\text{C}$
 I = actual current
 I_r = max. adjustment current of thermal release
 ① = thermal release zone when cold
 ② = thermal release zone when hot (in steady state)
 ③ = magnetic release zone

Thermal stress limitation curves

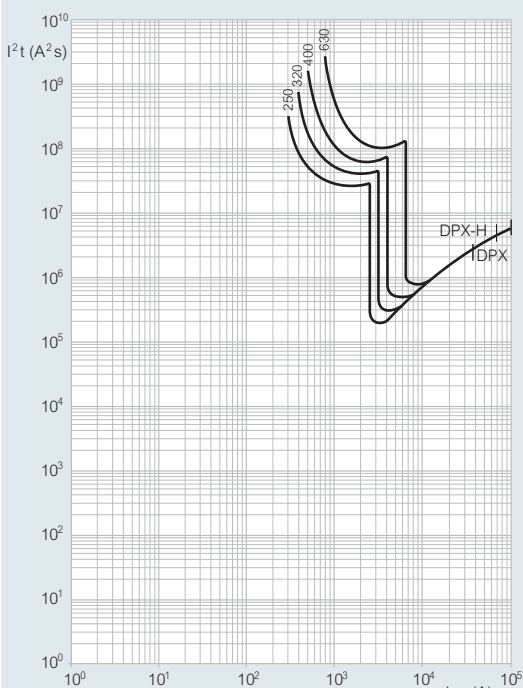

I_{cc} = prospective short-circuit symmetrical current (rms values in A)
 I^2t = limited thermal stress (in A²s)

Nominal breaking capacity (kA) (BS EN 60947-2)

Ue	DPX 630		DPX-H 630	
	Icu (kA)	Ics (%Icu)	Icu (kA)	Ics (%Icu)
400 V~	36	100	70	75
230 V~	60	100	100	75

Nominal current (In) for DPX 630 and DPX-H 630

Phase	320	400	500	630
N	320	400	500	630
N/2	250	250	250	320

Current limitation curves

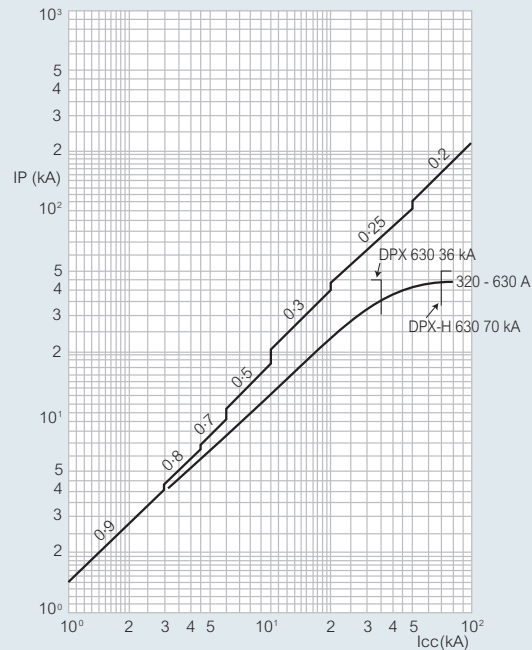

I_{cc} = prospective short-circuit symmetrical current (rms values in kA)
 I^2t = limited thermal stress (in A²s)

Differential tripping curves

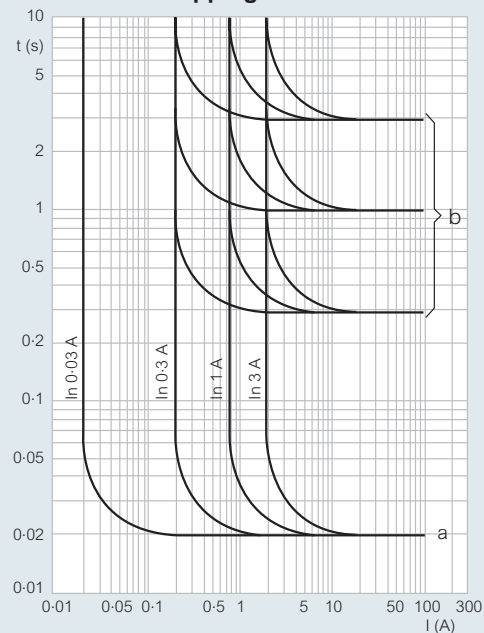

$I_D(A)$ = earth leakage current
 I_{Dn} = nominal earth leakage current
 a = instantaneous tripping point
 b = 3 possible delay settings (0.3, 1 and 3 seconds)

Electrical characteristics

Maximum nominal operating function	690 V~
Nominal frequency	50/60 Hz
Category of use	A
Thermal adjustment	0.8 to 1 In
Maximum permitted cross sections : - 2 cables via optional screw terminals (set of 1, Cat. No. 0262 69, see p. 68) - 4 cables via optional high capacity screw terminals (set of 1, Cat. No. 0262 70, see p. 68)	2 or 4 stranded cables : 240 mm ² 2 or 4 flexible cables : 185 mm ² copper bar (width) : 50 mm (M12)

Tripping curves

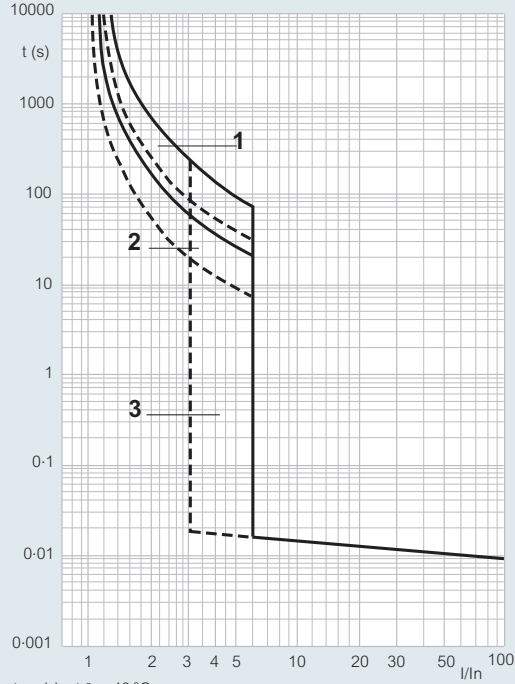

at ambient $\theta = 40^\circ\text{C}$
 I = actual current
 I_r = max. adjustment current of thermal release
 ① = thermal release zone when cold
 ② = thermal release zone when hot (in steady state)
 ③ = magnetic release zone

Thermal stress limitation curves

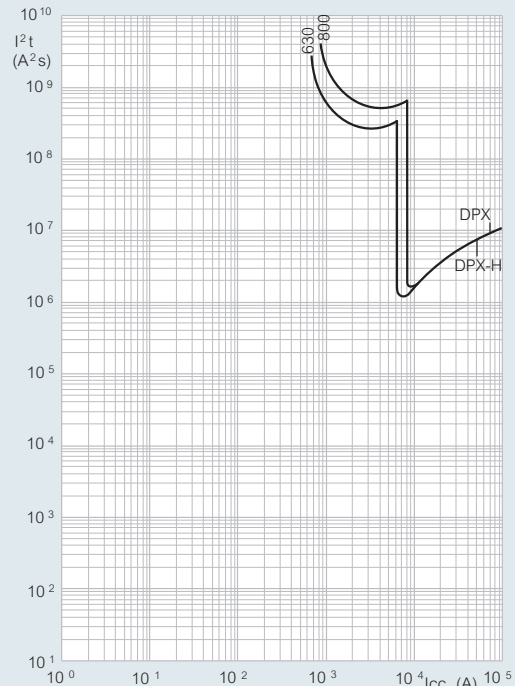

I_{cc} = prospective short-circuit symmetrical current (rms values in A)
 I^2t = limited thermal stress (in A²s)

Nominal breaking capacity (kA) (BS EN 60947-2)

Ue	DPX 1250		DPX-H 1250	
	Icu (kA)	Ics (%Icu)	Icu (kA)	Ics (%Icu)
400 V~	50	100	70	75
230 V~	80	100	100	75

Nominal current (In) for DPX 1250 and DPX-H 1250

Phase	630	800

Current limitation curves

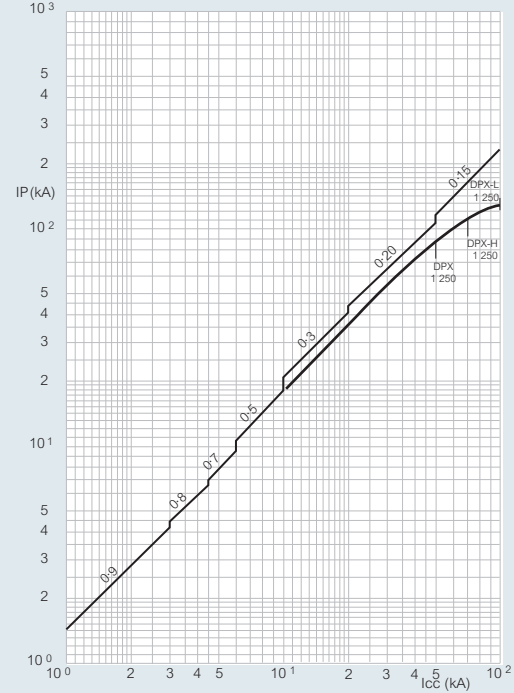

I_{cc} = prospective short-circuit symmetrical current (rms value in kA)
 IP = maximum peak value (in kA)
 ① = max. peak rms short-circuit currents
 ② = max. unlimited peak currents, corresponding to power factors indicated above (0.15 to 0.9)

Thermal stress limitation curves

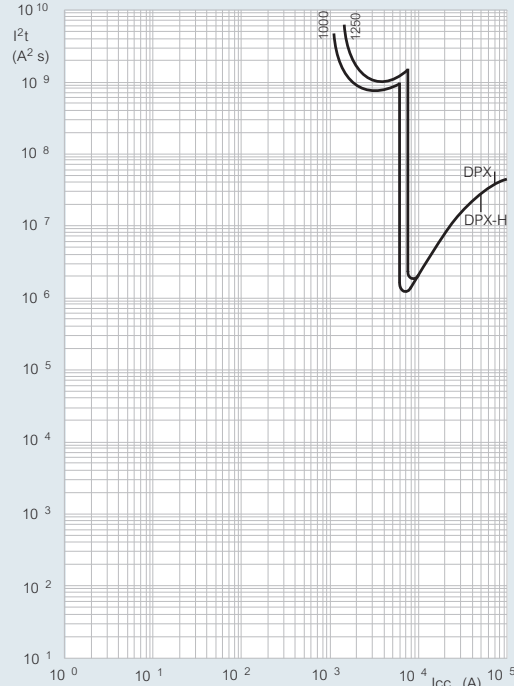

I_{cc} = prospective short-circuit symmetrical current (rms value in A)
 I^2t = limited thermal stress (in A²s)

DPX® selectivity table

■ Limits of selectivity (three phase circuit at 400 V)

Downstream MCCBs		Upstream MCCBs																	
		In (kA)	DPX 125 (16, 25 and 36 kA)				DPX 250 ER (25 and 36 kA)				DPX 250 DPX-H 250				DPX 630 DPX-H 630				DPX 1 250 630 A 800 A
DPX	Ist (kA)	40 A	63 A	100 A	125 A	63 A	100 A	160 A	250 A	63 A	100 A	160 A	250 A	320 A	400 A	500 A	630 A	630 A	800 A
DPX-E 125 (16 kA)	16 A	0.8	1	1.2	1.2	1	1.6	2.5	1	1.6	2.5	6	6	6	6	8	12	T	T
	25 A	0.8	1	1.2	1.2	1	1.6	2.5	1	1.6	2.5	6	6	6	6	8	12	T	T
	40 A		1	1.2	1.2	1	1.6	2.5	1	1.6	2.5	6	6	6	6	8	12	T	T
	63 A			1.2	1.2		1.6	2.5		1.6	2.5	6	6	6	6	8	12	T	T
	100 A						1.6	2.5		1.6	2.5	4	4	4	6	8	12	T	T
	125 A						1.6	2.5		1.6	2.5	4	4	4	6	8	12	T	T
DPX 125 (25 kA)	25 A	0.8	1	1.2	1.2	0.63	1	1.6	2.5	0.63	1	1.6	2.5	6	6	6	8	16	16
	40 A		1	1.2	1.2		1	1.6	2.5		1	1.6	2.5	6	6	6	8	16	16
	63 A			1.2	1.2			1.6	2.5			1.6	2.5	6	6	6	8	16	16
	100 A							1.6	2.5			1.6	2.5	4	4	6	8	16	16
	125 A							1.6	2.5			1.6	2.5	4	4	6	8	16	16
DPX 125 (36 kA)	16 A	0.8	1	1.2	1.2	0.63	1	1.6	2.5	0.63	1	1.6	2.5	6	6	6	8	16	16
	25 A	0.8	1	1.2	1.2		1	1.6	2.5		1	1.6	2.5	6	6	6	8	16	16
	40 A		1	1.2	1.2		1	1.6	2.5		1	1.6	2.5	6	6	6	8	16	16
	63 A			1.2	1.2			1.6	2.5			1.6	2.5	6	6	6	8	16	16
	100 A							1.6	2.5			1.6	2.5	4	4	6	8	16	16
	125 A							1.6	2.5			1.6	2.5	4	4	6	8	16	16
DPX 250 ER (25 kA)	63 A					0.63	1	1.6	2.5		1	1.6	2.5	3.2	4	5	6.3	16	16
	100 A							1.6	2.5			1.6	2.5	3.2	4	5	6.3	16	16
	160 A								2.5				2.5	3.2	4	5	6.3	16	16
	250 A													3.2	4	5	6.3	16	16
DPX 250 (36 kA)	63 A										1	1.6	2.5	3.2	4	5	6.3	16	16
	100 A											1.6	2.5	3.2	4	5	6.3	16	16
	160 A												2.5	3.2	4	5	6.3	16	16
	250 A													3.2	4	5	6.3	16	16
DPX-H 250 (70 kA)	63 A													3.2	4	5	6.3	16	16
	100 A													3.2	4	5	6.3	16	16
	160 A													3.2	4	5	6.3	16	16
	250 A													3.2	4	5	6.3	16	16
DPX 630 (36 kA)	320 A														4	5	6.3	10	10
	400 A															5	6.3	10	10
	500 A																6.3	10	10
	630 A																		10
DPX-H 630 (70 kA)	320 A														4	5	6.3	10	10
	400 A															5	6.3	10	10
	500 A																6.3	10	10
	630 A																		10
DPX 1 250 (50 kA)	630 A																		8
	800 A																		
DPX-H 1 250 (70 kA)	630 A																		8
	800 A																		

Note : Table contents shown in kA

■ Association and co-ordination of MCCBs (in kA)

In 3 phase networks + N 400/415 V~ according to BS EN 60947-2

	DPX 125 25 kA	DPX 125 36 kA	DPX 250 ER 36 kA	DPX 250 36 kA	DPX-H 250 70 kA	DPX 630 36 kA	DPX-H 630 70 kA	DPX 1 250 50 kA	DPX-H 1 250 70 kA
DPX-E 125	25	36	36	36	65	36	65	50	65
DPX 125 ⁽¹⁾		36	36	36	65	36	65	50	70
DPX 125 ⁽²⁾					70		70	50	70
DPX 250 ER ⁽³⁾					70		70	50	70
DPX 250 ER ⁽³⁾					70		70		70
DPX 250					70		70	50	70
DPX-H 250									
DPX 630							100	50	70
DPX-H 630								70	
DPX 1 250									70
DPX-H 1 250									

(1) 25 kA Icu (2) 36 kA Icu (3) 50 kA Icu

■ Association and co-ordination of MCCBs and MCBs (in kA)

In 3 phase networks 400 V~ according to IEC 60947-2

MCBs downstream		MCBs/MCCBs upstream														Fuses upstream				
		DX-H 10 kA ⁽²⁾ B and C curves		DPX-E 125	DPX 125	DPX 250 ER				DPX-H 250				DPX-H 630				DPX-H 1 250	gG TYPE	
		2 to 32 A	40 to 63 A	16 to 125 A	16 to 125 A	63 A	100 A	160 A	250 A	63 A	100 A	160 A	250 A	160 and 400 A	630 A			500 to 800 A	20 to 50 A	63 to 125 A
DX-E 6 kA DX-D D ⁽¹⁾ curve	1 to 20 A	25	12.5	16	25	25	25	25	25	25	25	25	25	25	25	25	100	100		
	25 A	25	12.5	16	25	25	25	25	25	25	25	25	25	25	25	20	100	100		
	32 A		12.5	16	25	25	25	25	25	25	25	25	25	25	15		100	100		
	40 A		12.5	16	25	25	25	25	25	25	25	25	20	20	15		100	100		
	50 A			16	25	25	25	20	20	25	25	20	15	15	15	12.5		100		
DX-H 10 kA B and C ⁽¹⁾ curves	63 A			16	25		20	15	15	20	20	15	15	15	15	12.5		100		
	1 to 16 A			16	25	25	25	25	25	25	25	25	25	25	25	25		100		
	20 A			16	25	25	25	25	25	25	25	25	25	25	25	25		100		
	25 A			16	25	25	25	25	25	25	25	25	25	25	25	20		100		
	32 A			16	25	25	25	25	25	25	25	25	25	25	15		100	100		
	40 A			16	25	25	25	25	25	25	25	20	20	20	15		100	100		
	50 A			16	25	25	25	20	20	25	25	20	15	15	15	12.5		100	100	
	63 A			16	25	25	20	15	15	20	20	15	15	15	15	12.5		100	100	
80 A				20		20	20		20	20	20	20	20	15	12.5		100	100		
100 A				20		20	20				20	20	20	15	12.5		100			
125 A							15	15			15	15	15	10	10		100			

(1) The magnetic threshold of the upstream circuit breaker must be higher than the magnetic threshold of the downstream circuit breaker
 (2) For DX-H 10 kA MCBs, see p. 79

■ Association and co-ordination of MCCBs and MCBs (in kA)

In 3 phase networks + N 230 / 240 V~ according to IEC 60947-2

MCBs downstream		MCBs/MCCBs upstream														Fuses upstream			
		DX-H 10 kA B and C curves		DPX-E 125	DPX 125	DPX 250 ER				DPX-H 250				DPX-H 630	DPX-H 1 250			gG TYPE	
		2 to 32 A	40 to 63 A	16 to 125 A	16 to 125 A	63 A	100 A	160 A	250 A	63 A	100 A	160 A	250 A	250 to 400 A	500 to 800 A			20 to 50 A	63 to 125 A
DX-E 6 kA DX-D D ⁽¹⁾ curve	1 to 25 A	50	25	22	35	50	50	50	50	50	50	50	50	50	50	100	100		
	32 & 40 A		25	22	35	50	50	50	50	50	50	50	50	50	50	100	100		
	50 A			16	25	36	36	36	36	45	45	36	30	30	25		100		
	63 A			16	25	30	30	30		45	30	30	30	25			100		
	80 A			16	25		25	25	25		25	25	25	25	20		100		
	100 A			16	25		25	25			25	25	25	25	20		100		
DX-H 10 kA B and C ⁽¹⁾ curves	125 A						25	25			25	25	25	20		100			
	1 to 40 A			22	35	50	50	50	50	50	50	50	50	50	50	100	100		
	50 A			16	25	36	36	36	36	45	45	36	30	30	25		100		
63 A			16	25	30	30	30		45	30	30	30	25			100			

(1) The magnetic threshold of the upstream circuit breaker must be higher than the magnetic threshold of the downstream circuit breaker

TT or TNS neutral earthing systems : For a 230 / 400 V supply in order to determine the breaking capacity of a 2 P MCB used as L + N (230 V) downstream a 2 P or 4 P circuit breaker use values indicated in the table for 230 / 240 V

Note : selectivity table - MCCBs (see p. 75)

DPX® 125 and 250 ER

DPX® 250

■ Dimensions

DPX 125 fixed version, front terminals

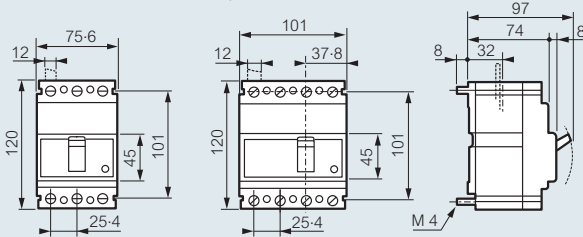

DPX 125 terminal shields

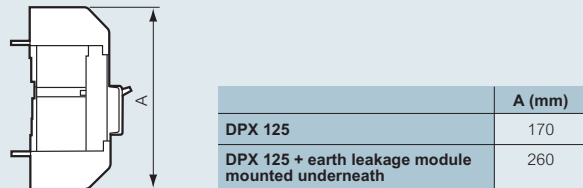

DPX 250 ER fixed version, front terminals

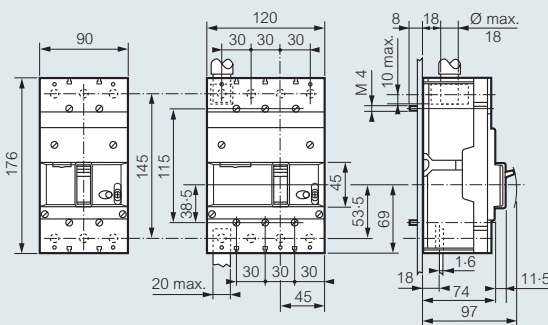

DPX 250 ER fixed version, with earth leakage module mounted underneath

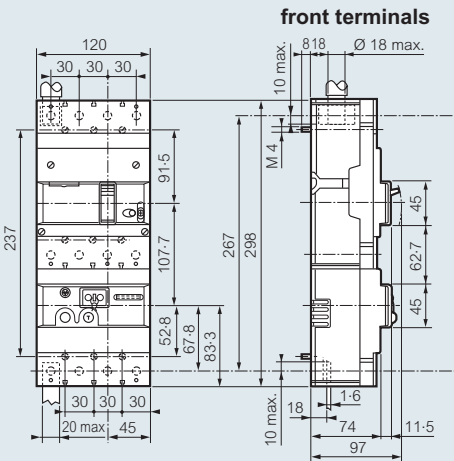

DPX 250 ER terminal shields

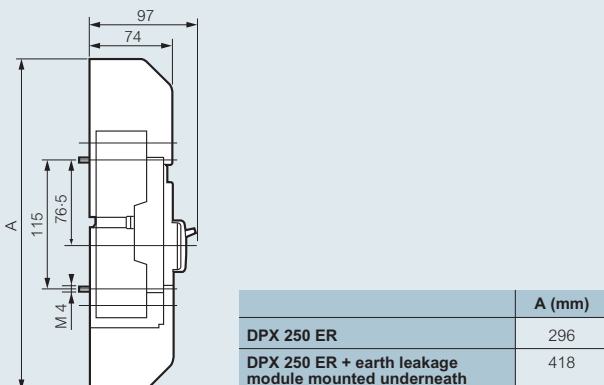

■ Dimensions

DPX 250 fixed version, front terminals

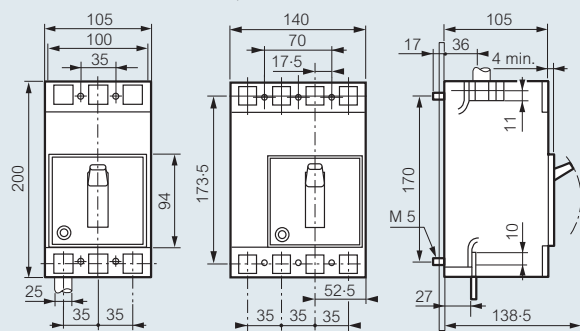

DPX 250 fixed version, with earth leakage module mounted underneath⁽¹⁾

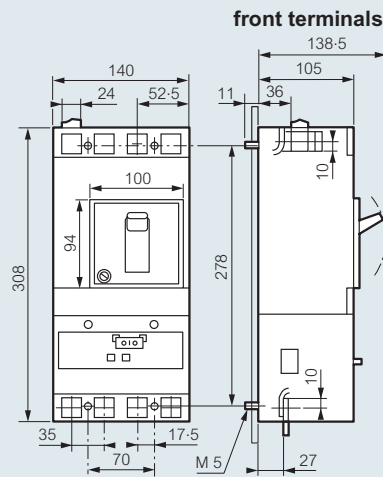

DPX 250 terminal shields

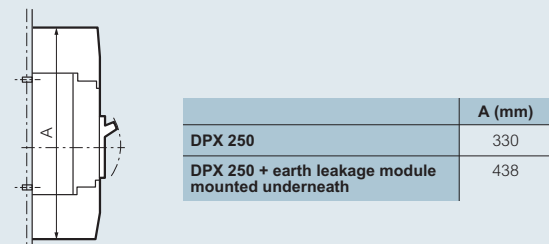

(1) The dimensions of the 3-pole earth leakage modules are the same as the dimensions of the 4-pole earth leakage modules

DPX® 630

■ Dimensions

DPX 630 fixed version, front terminals

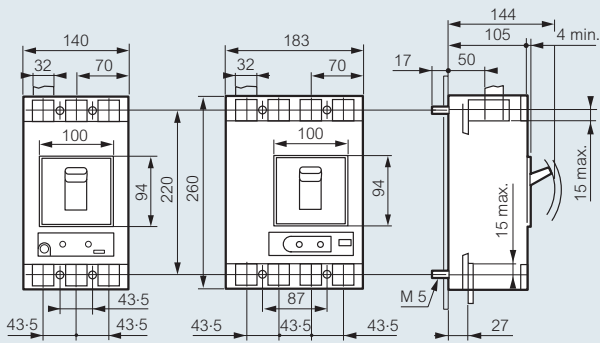

DPX 630 fixed version, with earth leakage module mounted underneath⁽¹⁾

front terminals

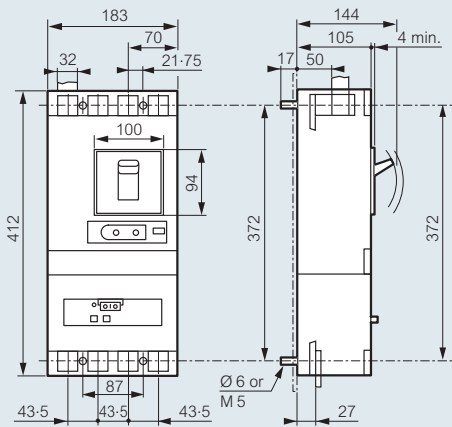

DPX 630 terminal shields

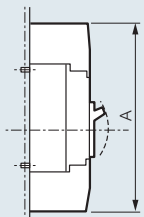

	A (mm)
DPX 630	390
DPX 630 + earth leakage module mounted underneath	542

DPX® 1250

■ Dimensions

DPX 1250 fixed version, front terminals

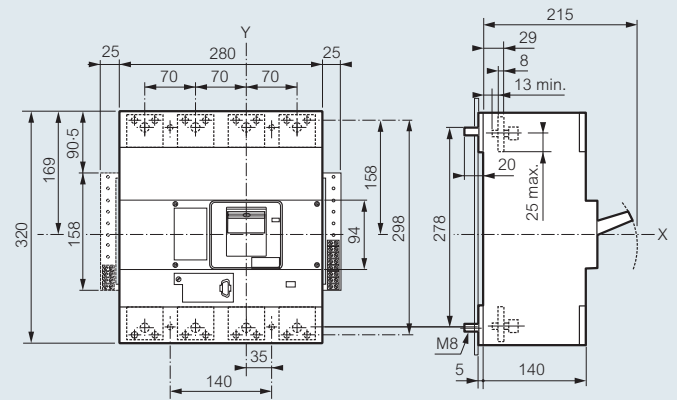
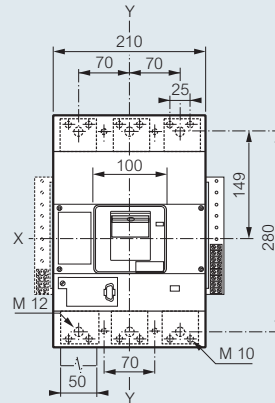

DPX 1250 terminal shields

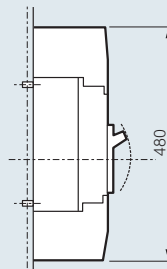

(1) The dimensions of the 3-pole earth leakage modules are the same as the dimensions of the 4-pole earth leakage modules

DX-H MCBs - 10 kA

thermal-magnetic MCBs up to 125 A
type B and C curves

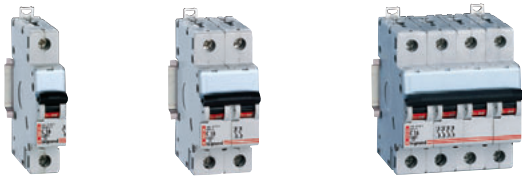

0068 60

0069 20

0070 00

Technical information (p. 80-82)
Dimensions (p. 88)

Breaking capacity : 10 kA to BS EN 60898-1
12.5 kA up to 25 kA to BS EN 60947-2 - 400 V \sim

Pack	Cat. Nos.		Nominal rating (A)	Number of 17.5 mm modules
	B curve	C curve		
1	0066 91	0068 52	1	1
1	0066 92	0068 53	2	1
1	0066 93	0068 54	3	1
1	0066 95	0068 56	6	1
10	0066 97	0068 58	10	1
10	0067 00	0068 60	16	1
1	0067 01	0068 61	20	1
1	0067 02	0068 62	25	1
1	0067 03	0068 63	32	1
1	0067 04	0068 64	40	1
1		0068 65	50	1
1	0067 06	0068 66	63	1
1		0063 83	80	1.5 ⁽¹⁾

Pack	Cat. Nos.		Nominal rating (A)	Number of 17.5 mm modules
	B curve	C curve		
1	0067 52	0069 12	1	2
1	0067 53	0069 13	2	2
1	0067 54	0069 14	3	2
1	0067 56	0069 16	6	2
1	0067 58	0069 18	10	2
5	0067 60		16	2
1		0069 20	16	2
1	0067 61	0069 21	20	2
1	0067 62	0069 22	25	2
1	0067 63	0069 23	32	2
1	0067 64	0069 24	40	2
1		0069 25	50	2
1	0067 66	0069 26	63	2
1		0064 75	80	3 ⁽¹⁾
1		0064 76	100	3 ⁽¹⁾
1		0064 77	125	3 ⁽¹⁾

Pack	Cat. Nos.		Nominal rating (A)	Number of 17.5 mm modules
	B curve	C curve		
1	0067 72	0069 32	1	3
1	0067 73	0069 33	2	3
1	0067 74	0069 34	3	3
1	0067 76	0069 36	6	3
1	0067 78	0069 38	10	3
1	0067 80	0069 40	16	3
1	0067 81	0069 41	20	3
1	0067 82	0069 42	25	3
1	0067 83	0069 43	32	3
1	0067 84	0069 44	40	3
1	0067 85	0069 45	50	3
1	0067 86	0069 46	63	3
1		0064 95	80	4.5 ⁽¹⁾
1		0064 96	100	4.5 ⁽¹⁾
1		0064 97	125	4.5 ⁽¹⁾

Pack	Cat. Nos.		Nominal rating (A)	Number of 17.5 mm modules
	B curve	C curve		
1	0068 32	0069 92	1	4
1		0069 93	2	4
1		0069 94	3	4
1	0068 36	0069 96	6	4
1	0068 38	0069 98	10	4
1	0068 40	0070 00	16	4
1	0068 41	0070 01	20	4
1	0068 42	0070 02	25	4
1	0068 43	0070 03	32	4
1	0068 44	0070 04	40	4
1	0068 45	0070 05	50	4
1	0068 46	0070 06	63	4
1		0065 70	80	6 ⁽¹⁾
1		0065 71	100	6 ⁽¹⁾
1		0065 72	125	6 ⁽¹⁾

(1) These MCBs are for standalone use only, not with distribution boards
(2) Suitable for type B flexible boards only

DX-D MCBs - 10 kA

thermal-magnetic MCBs up to 125 A
type D curve



0066 33

0066 56

0066 71

Technical information (p. 80-82)
Dimensions (p. 88)

Breaking capacity : 6 kA to BS EN 60898-1 up to 63 A - 400 V \sim
10 kA to BS EN 60898-1 80 A to 125 A

15 kA to BS EN 60947-2 up to 32 A - 400 V \sim
10 kA to BS EN 60947-2 40 A to 125 A - 400 V \sim
Magnetic adjusted between 10 and 14 In

Pack	Cat. Nos.		Nominal rating (A)	Number of 17.5 mm modules
	D curve			
1	0065 75		1	1
1	0065 76		2	1
1	0065 77		3	1
1	0065 78		4	1
1	0065 79		6	1
1	0065 81		10	1
1	0065 83		16	1
1	0065 84		20	1
1	0065 85		25	1
1	0065 86		32	1
1	0065 87		40	1
1	0065 88		50	1
1	0065 89		63	1

Pack	Cat. Nos.		Nominal rating (A)	Number of 17.5 mm modules
	D curve			
1	0066 25		1	2
1	0066 26		2	2
1	0066 27		3	2
1	0066 28		4	2
1	0066 29		6	2
1	0066 31		10	2
1	0066 33		16	2
1	0066 34		20	2
1	0066 35		25	2
1	0066 36		32	2
1	0066 37		40	2
1	0066 38		50	2
1	0066 39		63	2
1	0066 40		80	3 ⁽¹⁾
1	0066 41		100	3 ⁽¹⁾
1	0066 42		125	3 ⁽¹⁾

Pack	Cat. Nos.		Nominal rating (A)	Number of 17.5 mm modules
	D curve			
1	0066 45		1	3
1	0066 46		2	3
1	0066 47		3	3
1	0066 48		4	3
1	0066 49		6	3
1	0066 51		10	3
1	0066 53		16	3
1	0066 54		20	3
1	0066 55		25	3
1	0066 56		32	3
1	0066 57		40	3
1	0066 58		50	3
1	0066 59		63	3
1	0066 60		80	4.5 ⁽¹⁾
1	0066 61		100	4.5 ⁽¹⁾
1	0066 62		125	4.5 ⁽¹⁾

Pack	Cat. Nos.		Nominal rating (A)	Number of 17.5 mm modules
	D curve			
1	0066 65		1	4
1	0066 66		2	4
1	0066 67		3	4
1	0066 68		4	4
1	0066 69		6	4
1	0066 71		10	4
1	0066 73		16	4
1	0066 74		20	4
1	0066 75		25	4
1	0066 76		32	4
1	0066 77		40	4
1	0066 78		50	4
1	0066 79		63	4
1	0066 80		80	6 ⁽¹⁾
1	0066 81		100	6 ⁽¹⁾
1	0066 82		125	6 ⁽¹⁾

(1) These MCBs are for standalone use only, not with distribution boards
(2) Suitable for type B flexible boards only

DX-H, DX-D MCBs

■ Technical information

- Maximum voltage : 240 V - 415 V \sim \pm 10 %
- Maximum voltage : 80 V $\overline{=}$ per pole
- Insulation voltage : 500 V \sim
- Dielectric : 2 500 V \sim

Power dissipated in W per pole at In

In A	1	2	3	4	6	10	16	20	25	32	40	50	63	80	100	125
Type B	2·1	2·1	2·4	2·5	1·1	1·1	1·5	1·7	2·4	3·1	4	4·5	5·5	–	–	–
Type C	2·1	2·1	2·4	2·5	1·1	1·1	1·5	1·7	2·4	3·1	4	4·5	5·5	8·8	7·8	15·6
Type D	2·1	2·1	2·4	2·5	1·1	1·1	1·5	1·7	2·4	3·1	4	4·5	5·5	8·8	7·8	15·6

■ Mechanical characteristics

Endurance : 20 000 mechanical switching operations
10 000 on load switching operations at In x cos φ 0·9

	In \geq 63 A	In \geq 80 A
Connection cross sections (in mm ²)	25 mm ² flexible cable 35 mm ² stranded cable	50 mm ² flexible cable 70 mm ² stranded cable
Applied connection torque	2·5 Nm	3 Nm

Derating according to ambient temperature (In A)

In at 30 °C	Ambient temperature						
	0 °C	10 °C	20 °C	30 °C	40 °C	50 °C	60 °C
1	1·1	1·07	1·03	1	0·97	0·93	0·90
2	2·2	2·1	2·06	2	1·94	1·86	1·80
3	3·3	3·2	3·1	3	2·9	2·8	2·6
4	4·4	4·2	4·1	4	3·9	3·8	3·6
6	6·6	6·4	6·2	6	5·8	5·5	5·4
10	11	10·7	10·3	10	9·7	9·3	9·0
16	18	17·3	16·6	16	15·4	14·7	14·1
20	22·4	21·6	20·8	20	19·2	18·4	17·6
25	28·3	27·2	26	25	24	22·7	21·7
32	36·2	34·9	33·3	32	30·7	29·1	27·8
40	46	44	42	40	38	36	34
50	57·5	55	52·5	50	47·5	45	42·5
63	73·1	69·9	66·1	63	59·8	56·1	52·9
80	91	88	84	80	76	72	69
100	114	110	105	100	95	90	86
125	142	137	131	125	119	113	108

■ Technical information

Derating according to the number of adjacent MCBs

Number of adjacent MCBs	from 1 to 3	from 4 to 6	from 7 to 9	over 10
Coefficient	1	0·8	0·7	0·6

■ MCB supplementary data (6 kA and 10 kA)

Terminal depth : 14 mm
Terminals protected to IP 20
Maximum terminal torque : 3 Nm
(recommended : 2·5 Nm)

Enclosure material : polyester
self-extinguishing at 960 °C

Average weight per pole : 0·160 kg

Supply : can be supplied from the top or bottom

Padlockable in either ON or OFF position

Operation with DC voltage supply : up to a maximum of 80 V DC per pole – for voltages above 80 V DC use multipole devices wired IN SERIES (e.g. two pole 160 V $\overline{=}$ maximum)

Positive contact position indication in accordance with BS 7671 : 2008 IEE Wiring Regulations, 17th Edition

DX-H, DX-D MCBs

tripping and operating curves

MCB tripping curves

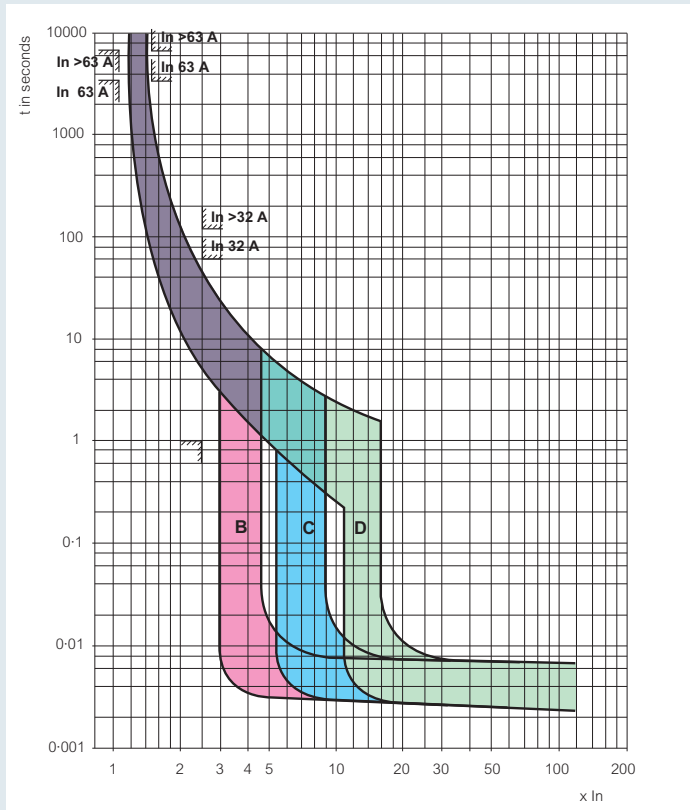

Operating curves DX-H type B from 1 A to 63 A

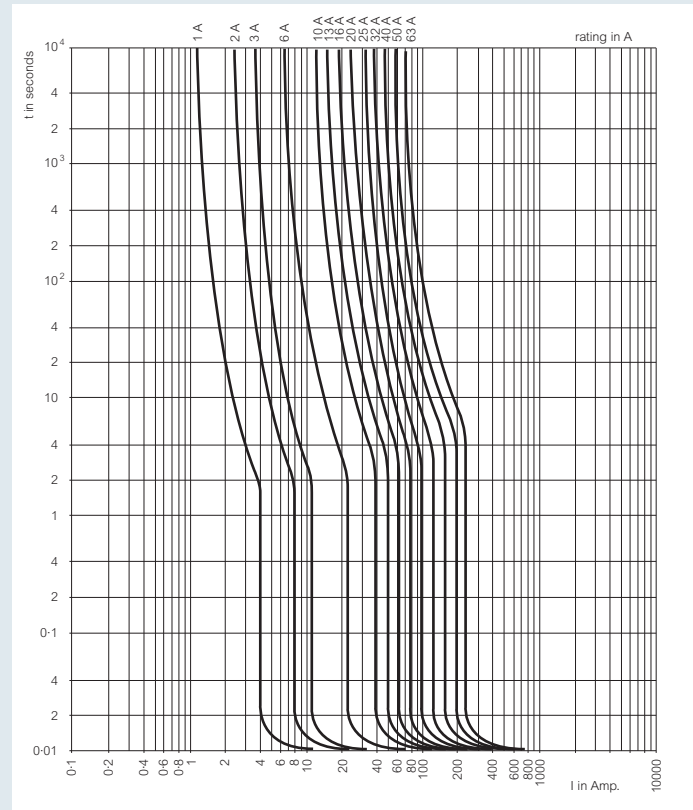

Standard BS EN 60898 defines type B magnetic curve between 3 and 5 I_n

Operating curves DX-H type C from 1 A to 63 A and DX-H from 1 to 125 A

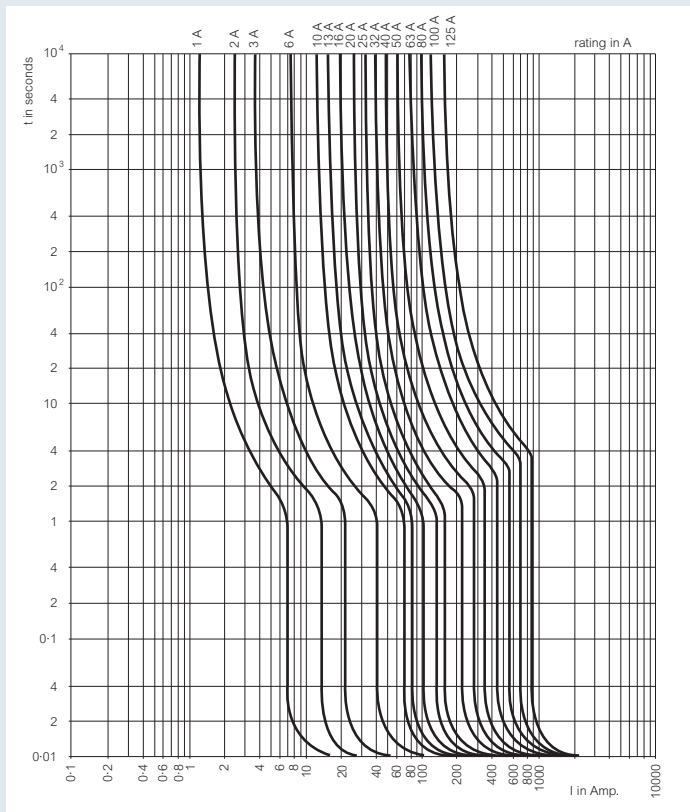

Standard BS EN 60898 defines type C magnetic curve between 5 and 10 I_n

Operating curves DX-D type D from 1 A to 125 A

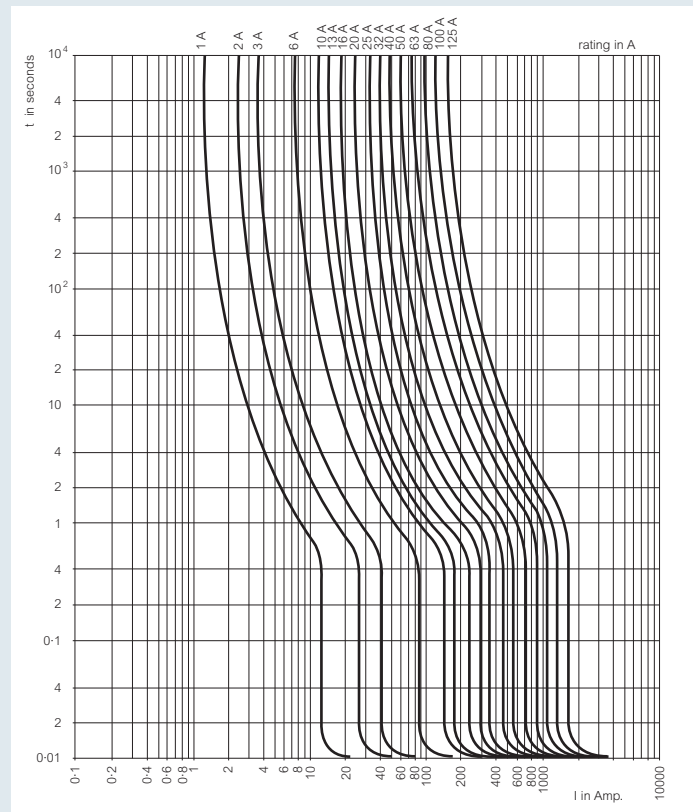

Standard BS EN 60898 defines type D magnetic curve between 10 and 20 I_n

discrimination/selectivity tables - average values of selectivity limits (A)

MCBs/MCBs

MCBs downstream		MCBs upstream																													
		DX-H C curve											DX-D D curve										DX-H B curve								
		10 A	16 A	20 A	25 A	32 A	40 A	50 A	63 A	80 A	100 A	125 A	10 A	16 A	20 A	25 A	32 A	40 A	50 A	63 A	80 A	100 A	125 A	10 A	16 A	20 A	25 A	32 A	40 A	50 A	63 A
DX-H C curve	1 to 4 A	75	120	150	187	240	300	375	472	480	600	750	120	192	240	300	384	480	600	756	800	T	T	40	64	80	100	128	160	200	252
	6 A	75	120	150	187	240	300	375	472	480	600	750	120	192	240	300	384	480	600	756	800	1 200	1 500		64	80	100	128	160	200	252
	10 A		120	150	187	240	300	375	472	480	600	750		192	240	300	384	480	600	756	800	1 200	1 500				100	128	160	200	252
	16 A			150	187	240	300	375	472	480	600	750			240	300	384	480	600	756	800	1 200	1 500						160	200	252
	20 A				187	240	300	375	472	480	600	750				300	384	480	600	756	800	1 200	1 500							200	252
	25 A					240	300	375	472	480	600	750					384	480	600	756	800	1 200	1 500								252
	32 A						300	375	472	480	600	750						480	600	756	800	1 200	1 500								
	40 A							375	472	480	600	750							600	756	800	1 200	1 500								
	50 A								472	480	600	750								756	800	1 200	1 500								
	63 A									480	600	750									800	1 200	1 500								
	80 A										600	750										1 200	1 500								
	100 A											750											1 500								
125 A												750											1 500								
DX-D D curve	1 to 4 A	75	120	150	187	240	300	375	472	480	600	750	120	192	240	300	384	480	600	756	800	T	T	40	64	80	100	128	160	200	252
	6 A		120	150	187	240	300	375	472	480	600	750	120	192	240	300	384	480	600	756	800	1 200	1 500		64	80	100	128	160	200	252
	10 A			150	187	240	300	375	472	480	600	750		192	240	300	384	480	600	756	800	1 200	1 500					160	200	252	
	16 A					240	300	375	472	480	600	750			240	300	384	480	600	756	800	1 200	1 500							252	
	20 A						300	375	472	480	600	750				300	384	480	600	756	800	1 200	1 500								
	25 A							375	472	480	600	750					384	480	600	756	800	1 200	1 500								
	32 A								472	480	600	750						480	600	756	800	1 200	1 500								
	40 A									480	600	750							600	756	800	1 200	1 500								
	50 A										600	750								756	800	1 200	1 500								
	63 A											750									800	1 200	1 500								
	80 A												750									1 200	1 500								
	100 A													750									1 500								
125 A														750									1 500								
DX-H B curve	1 to 4 A	75	120	150	187	240	300	375	472	480	600	750	120	192	240	300	384	480	600	756	800	1 200	1 500	40	64	80	100	128	160	200	252
	10 A		120	150	187	240	300	375	472	480	600	750		192	240	300	384	480	600	756	800	1 200	1 500		64	80	100	128	160	200	252
	16 A			150	187	240	300	375	472	480	600	750			240	300	384	480	600	756	800	1 200	1 500			80	100	128	160	200	252
	20 A				187	240	300	375	472	480	600	750				300	384	480	600	756	800	1 200	1 500				100	128	160	200	252
	25 A					240	300	375	472	480	600	750					384	480	600	756	800	1 200	1 500					128	160	200	252
	32 A						300	375	472	480	600	750						480	600	756	800	1 200	1 500						160	200	252
	40 A							375	472	480	600	750							600	756	800	1 200	1 500							200	252
	50 A								472	480	600	750								756	800	1 200	1 500								252
	63 A									480	600	750									800	1 200	1 500								

Upstream fuse

MCBs downstream		gG type												
		32 A	40 A	50 A	63 A	80 A	100 A	125 A	160 A					
DX-H B and C curves	0-5 to 6 A	1 600	1 900	2 500	4 000	4 600	11 000	25 000	T					
	8 A	1 600	1 900	2 500	4 000	4 600	11 000	25 000	T					
	10 A		1 600	2 200	3 200	3 600	7 000	11 000	20 000					
	16 A			1 400	1 800	2 600	3 000	5 600	8 000	15 000				
	20 A				1 200	1 500	2 200	2 500	4 600	6 300	10 000			
	25 A					1 300	2 000	2 200	4 100	5 500	8 000			
	32 A						1 200	1 700	1 900	3 500	4 500	7 000		
	40 A								1 700	3 000	4 000	5 000		
	50 A									1 600	2 600	3 500	4 500	
	63 A										2 400	3 300	4 500	
	80 A											3 000	6 000	8 000
	100 A												4 000	5 000
125 A													4 000	

T : total selectivity up to MCB breaking capacity according to IEC 60947-2

DX™ RCDs

residual current devices - types AC and A



Dimensions (p. 88)

Conform to BS EN 61008-1

- AC type - Standard applications

AC type RCDs detect AC residual currents. In the majority of cases (standard applications), they are used for AC current detection at 50/60 Hz

- A type - Specific applications : dedicated lines

In addition to the characteristics of AC type RCDs, A type RCDs also detect DC residual currents. A type are used whenever fault currents are not sinusoidal. A type are particularly suitable for specific applications (dedicated lines) or circuits that may produce DC fault currents, eg variable speed drives with frequency inverters, etc.

Locking possible using support for padlock Cat. No. 0044 42 (p. 90)

Test voltage

	RCD	
	2 P	4 P
Min.	135 V (10/30/300 mA)	195 V (30 mA) 230 V (100 mA) 215 V (300 mA) 295 V (500 mA)
Max.	250 V	440 V

Pack	Cat. Nos.		Double pole - 230 V~	
	Type AC	Type A	Nominal rating (A)	Number of 17.5 mm modules
1	0089 06	0090 53	10 mA 16	2
1	0089 09	0090 56	30 mA 25	2
1	0089 10	0090 57	40	2
1	0089 11	0090 58	63	2
1	0089 12	0090 59	80	2
1	6027 10		100	2
1	0089 15		100 mA 25	2
1	0089 16		40	2
1	0089 17		63	2
1	0089 18		80	2
1	6027 11		100 mA discriminating 100	2
1	0089 27	0090 74	300 mA 25	2
1	0089 28	0090 75	40	2
1	0089 29	0090 76	63	2
1	0089 30	0090 77	80	2
1	0089 35	0090 82	300 mA discriminating 63	2

Pack	Cat. Nos.		Four pole - 400 V~ neutral on right (continued)	
	Type AC	Type A	Nominal rating (A)	Number of 17.5 mm modules
1	0090 23		500 mA 25	4
1	0090 24	0091 71	40	4
1	0090 25	0091 72	63	4
1	0090 26	0091 73	80	4
1	0090 18	0091 65	300 mA discriminating 40	4
1	0090 19	0091 66	63	4

Pack	Cat. Nos.	Four pole - 400 V~ neutral on left		
		Type AC	Nominal rating (A)	Number of 17.5 mm modules
1	0086 96		30 mA 80	4
1	0087 14		300 mA 80	4

Pack	Cat. Nos.		Four pole - 400 V~ neutral on right	
	Type AC	Type A	Nominal rating (A)	Number of 17.5 mm modules
1	0089 93	0091 40	30 mA 25	4
1	0089 94	0091 41	40	4
1	0089 95	0091 42	63	4
1	0089 96	0091 43	80	4
1	0089 99	0091 46	100 mA 25	4
1	0090 00	0091 47	40	4
1	0090 01	0091 48	63	4
1	0090 02	0091 49	80	4
1		0091 50	100	4
1	0090 11	0091 58	300 mA 25	4
1	0090 12	0091 59	40	4
1	0090 13	0091 60	63	4
1	0090 14	0091 61	80	4
1		0091 62	100	4

Auxiliaries for MCBs and RCDs

Clip on the left hand side of the MCB (maximum 3)
Allow insertion of the supply busbar at the top
Auxiliaries common to DX-H MCBs and DX RCDs

Signalling auxiliaries

Pack	Cat. Nos.	Description	Number of 17.5 mm modules
1	0073 50	Auxiliary changeover switch, 6 A - 250 V~ Indicates the position of the contacts	0-5
1	0073 51	Fault signalling changeover switch, 6 A - 250 V~ Indicates tripping of the MCB at a fault	0-5
1	0073 53	Auxiliary changeover switch, 6 A - 250 V which can be modified to a fault signalling switch	0-5
1	0073 54	Auxiliary changeover switch, 6 A - 250 V + fault signalling switch, can be modified to 2 auxiliary changeover switches	1

DX™ RCB0s - 10 kA and auxiliaries

up to 63 A - type AC
type B and C curves

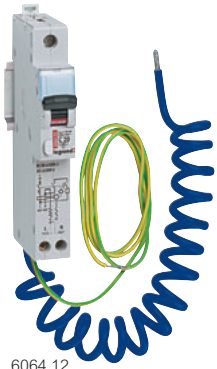

6064 12



0078 86



0079 19



0079 80



Dimensions (p. 88)

Conform to BS EN 61009-1
Breaking capacity : 10 kA to BS EN 61009-1
10 kA to BS EN 60947-2 (except for single pole + neutral - 6 kA)

Pack	Cat. Nos.	Single pole + neutral - 230 V~	
	Type AC	Single pole with solid unswitched neutral Suitable for type B standard or flexible boards and type A boards	
	C curve	Nominal rating (A)	Number of 17.5 mm modules
		30 mA	
1	6064 10	10	1
1	6064 11	16	1
1	6064 12	20	1
1	6064 13	25	1
1	6064 14	32	1
1	6064 15	45	1

Pack	Type AC		Single pole + neutral - 230 V~	
	B curve	C curve	Single pole with switched neutral Suitable for type B flexible boards only Neutral on right	
			Nominal rating (A)	Number of 17.5 mm modules
			10 mA	
1		0078 79	16	2
			30 mA	
1		0078 81	3	2
1	0077 77	0078 83	6	2
1	0077 78	0078 84	10	2
1	0077 80	0078 86	16	2
1	0077 81	0078 87	20	2
1		0078 88	25	2
1	0077 83	0078 89	32	2
1	0077 84	0078 90	40	2
			300 mA	
1		0078 94	6	2
1		0078 95	10	2
1		0078 97	16	2
1		0078 98	20	2
1		0078 99	25	2
1		0079 00	32	2
1		0079 01	40	2

Pack	Cat. Nos.	Double pole - 230/400 V~			
	Type AC	Suitable for type B flexible boards only			
	C curve	Nominal rating (A)	Number of 17.5 mm modules	Breaking capacity IEC 60947-2 (kA)	
				400 V~	230 V~
		10 mA			
1	0077 45	10	4	10	25
1	0077 46	16	4	10	25
1	0077 47	20	4	10	25
		30 mA			
1	0079 11	10	4	10	25
1	0079 19	16	4	10	25
1	0079 20	20	4	10	25
1	0079 21	25	4	10	25
1	0079 22	32	4	10	25
1	0079 29	40	4	10	25
1	0079 30	50	4	10	25
1	0079 31	63	4	10	25

Pack	Cat. Nos.	Four pole - 400 V~			
	Type AC	Suitable for type B flexible boards only			
	C curve	Nominal rating (A)	Number of 17.5 mm modules	Breaking capacity IEC 60947-2 (kA)	
				400 V~	230 V~
		30 mA			
1	0079 62	10	4	10	10
1	0079 64	16	4	10	10
1	0079 65	20	4	10	10
1	0079 66	25	4	10	10
1	0079 67	32	4	10	10
1	0080 13	40	7	10	25
1	0080 14	50	7	10	25
1	0080 15	63	7	10	25
		300 mA			
1	0079 75	10	4	10	10
1	0079 77	16	4	10	10
1	0079 78	20	4	10	10
1	0079 79	25	4	10	10
1	0079 80	32	4	10	10
1	0080 31	40	7	10	25
1	0080 32	50	7	10	25
1	0080 33	63	7	10	25

metering



0046 02



0046 00



0046 64



0046 52

Technical information (p. 87)
Dimensions (p. 88)

Pack	Cat. Nos.	Analogue ammeters	Number of modules
1	0046 02	Measure the intensity of the current circulating in an electrical circuit in Amperes (A) Direct connection To alternating or direct current Range : 0-30 A	4
1	0046 00	Connected using a 5 A current transformer (CT) The meter is fitted with an appropriate dial for the intensity of the current being measured	4
Measuring dials for ammeter Cat. No. 0046 00			
2	0046 10	0-50 A	
2	0046 13	0-100 A	
2	0046 15	0-200 A	
2	0046 17	0-300 A	
2	0046 18	0-400 A	
2	0046 20	0-600 A	
2	0046 21	0-800 A	
2	0046 22	0-1 000 A	
2	0046 24	0-1 500 A	
2	0046 25	0-2 000 A	

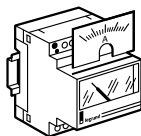

Pack	Cat. Nos.	Analogue voltmeter	Number of modules
1	0046 60	For measuring the AC or DC voltage (V) in an electrical circuit Range 0-500 V	4

Pack	Cat. Nos.	Current transformers (CT)	Number of modules
IP20 Used with ammeters or electricity meters Supply a current of 0 to 5 A to the secondary which is proportional to the primary current Fix to plate or rail EN 60715 Secondary joining with terminals for lugs, cage terminals or screws			
		Transformation ratio	Power in VA
Single phase CT			
For cable Ø 21 mm and 16 x 12.5 mm bar			
1	0046 31	50/5	1-25
1	0046 34	100/5	2-5
1	0046 36	200/5	5-5
For cable Ø 23 mm and 20.5 x 12.5 and 30 x 10.5 mm bar			
1	0047 75	300/5	11
For cable Ø 35 mm and 40.5 x 10.5 mm bar			
1	0046 38	400/5	12
For 32 x 65 mm bar			
1	0047 76	600/5	15
1	0047 77	800/5	12
1	0047 78	1 000/5	20
For 38 x 127 mm bar			
1	0046 45	1 500/5	15
1	0046 46	2 000/5	20

Pack	Cat. Nos.	Digital ammeter / voltmeter	Number of modules
1	0046 63	Display from 0 to 999 A, kA, V Measures the current or the voltage of the circuit depending on the connection made - ammeter mode : connected via a 0-5 A current transformer (CT). Reading range adjusted according to CT used (100, 400, 600 or 1 000 A) Voltage : 230 V~ - 50/60 Hz Scale : 0 - 4 000 V - voltmeter mode : measures the AC or DC voltage of an electrical circuit Scale : 0 - 500 V	4

Pack	Cat. Nos.	Digital frequency meter	Number of modules
1	0046 64	For measuring the frequency of a 100 to 500 V~ electrical circuit in Hertz (Hz) Green LED 3 digit display - 10-100 Hz display	4

Pack	Cat. Nos.	Selector switches	Number of modules
1	0046 50	For manual switching of circuits being measured 4-position ammeter selector switch For measuring currents in a 3 phase circuit using only one ammeter with a current transformer	3
1	0046 52	4-position voltmeter selector switch For measuring phase-to-phase voltages of a 3 phase circuit without neutral using only one voltmeter	3
1	0046 53	7-position voltmeter selector switch For measuring phase-to-phase voltages and phase-neutral voltages of a 3 phase circuit with neutral	3



metering

(continued)



0046 72



0046 74



0046 94



0046 91

Technical information (p. 87)
Dimensions (p. 88)

Pack	Cat. Nos.	Single phase meters	Number of 17.5 mm modules
		Direct connection	
		Single phase direct connection	
		Power supply : 230 V~ - 50/60 Hz	
		Without pulse transmitter	
1	0046 81	Up to 32 A Display : LCD screen 6 digits including 1 decimal place 1 unit = 0.1 kWh Partial counting with reset	2
1	0046 72	Up to 63 A Display : LCD screen 5 digits, 1 unit = 1 kWh Partial counting with reset	2

Pack	Cat. Nos.	Three phase meters	Number of 17.5 mm modules
		Power supply : 400 V~ - 50/60 Hz (3 phase + N) Display : LCD screen 5 digits, 1 unit = 1 kWh With pulse transmitter to feed back remote electrical energy consumption measurements via volt-free contact	
		Direct connection	
1	0046 73	Up to 63 A per phase Partial counting with reset 1 x 200 ms pulse every 10 kWh	4
		Connection via a 0.5 A current transformer (CT)	
1	0046 74	Current transformation ratio : 50/5 to 4 000/5 1 x 200 ms pulse every 10 kWh	4
		Three phase CT connection	
		10/x 200 ms pulses per kWh (x = rating of CT)	

Pack	Cat. Nos.	Totalising hour counters	Number of 17.5 mm modules
		Used to count the operating hours of a machine or an electrical device to determine the exact operating duration and thus perform preventative maintenance as necessary	
		Counter with digital display	
		Capacity : 5 digits + 2 decimals (1 unit = 1 hour)	
		Precision : 1/100 hour Consumption : 0.2 VA	
1	0046 94	230 V~ - 50 Hz	2
1	0046 91	24 V~ - 50 Hz	2

metering

■ Ammeters

Technical characteristics

Type of measurement	Analogue		Digital
	Ferromagnetic		Electronic via shunt
Frequency	50 to 60 Hz		50 to 60 Hz
Precision	1.5 %		± 1 % to ± 1 digit
Operating temperature	-10 °C to +40 °C		-10 °C to +40 °C
Storage temperature	-20 °C to +80 °C		-20 °C to +70 °C
Consumption :	-		4.5 VA
• voltage circuit	-		1 VA
• measurement circuit	1.1 VA		
Connection size	Direct	Via CT	2 x 2.5 mm ²
	6 mm ²	4 mm ²	
Conformity to standards	EN 61010-1		EN 61010-1

Ammeter connected directly

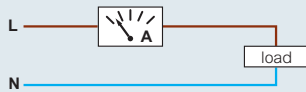

Ammeter connected via current transformer

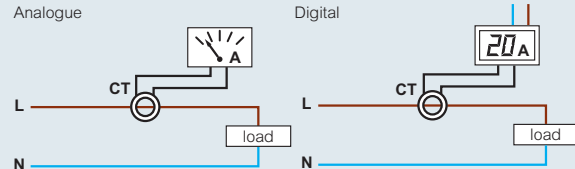

3 phase using ammeter selector switch

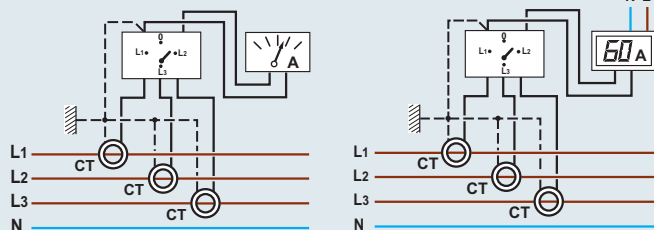

■ Current transformers (CT)

Dimensions

		Opening for cable Max. Ø (mm)	Opening for bar w. X th. (mm)	Fixing centres on plate (mm)
CT 50/5 100/5 200/5		Ø 21	16 x 12.5	on rail EN 60715
CT 300/5		Ø 23	20.5 x 12.5 25.5 x 11.5 30.5 x 10.5	55 x 45
CT 400/5		Ø 35	40.5 x 10.5	54 x 45
CT 600/5 800/5 1000/5		-	32 x 65	fix on bar
CT 1500/5 2000/5		-	38 x 127	fix on bar

Technical characteristics

Degree of protection	IP 20
Using frequency	50/60 Hz

■ Voltmeters

Technical characteristics

Type of measurement	Analogue		Digital
	Ferromagnetic		Electronic integration
Frequency	50 to 60 Hz		50 to 60 Hz
Precision	1.5 %		± 1 % to ± 1 digit
Operating temperature	-10 °C to +40 °C		-10 °C to +40 °C
Storage temperature	-20 °C to +80 °C		-20 °C to +70 °C
Consumption	3 VA		4.5 VA
Connection size	2 x 2.5 mm ²		2 x 2.5 mm ²
Conformity to standards	EN 61010-1		EN 61010-1

Voltmeter

Analogue

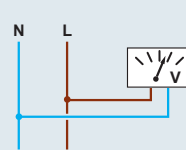

Digital

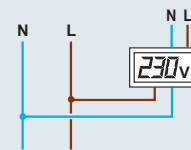

3 phase using 7-position voltmeter selector switch for phase-to-phase and phase-neutral measurement

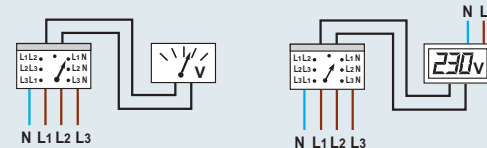

3 phase using 4-position voltmeter selector switch for phase-to-phase measurement

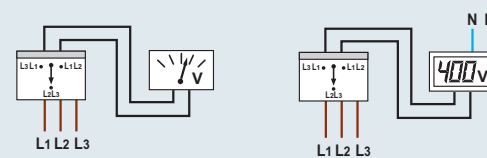

■ Frequency meter

Technical characteristics

Type of measurement	Quartz electronic
Precision	± 0.2 % to ± 1 digit
Operating temperature	-10 °C to +40 °C
Storage temperature	-20 °C to +70 °C
Consumption	4.5 VA
Connection size	2 x 2.5 mm ²
Conformity to standards	EN 61010-1

modular DIN rail equipment

dimensions

■ Dimensions

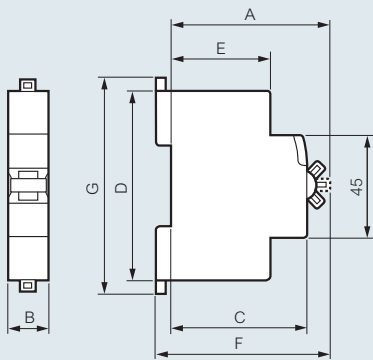

Description	Dimension (mm)										
	A	B					C	D	E	F	G
		1-pole	1-pole + N	2-pole	3-pole	4-pole					
DX-H, DX-D up to 63 A	70	17.7	-	35.6	53.4	71.2	60	83	44	76	94
DX-D, DX-H from 80 to 125 A	70	26.7	-	53.4	80.1	106.8	60	83	44	76	89
RCBOs	70	-	35.6	71.2	-	124.6	60	83	44	76	94
4-pole RCBOs with 4 modules	70	-	-	-	-	71.2	60	83	44	76	94
RCDs 2-pole	70	-	-	35.6	-	-	60	83	44	76	94
4-pole	71.5	-	-	-	-	71.2	60	83	44	77.5	94
Fuse carriers	67	17.7	17.7	35.6	53.4	71.2	60	83	44	73	94

■ Dimensions

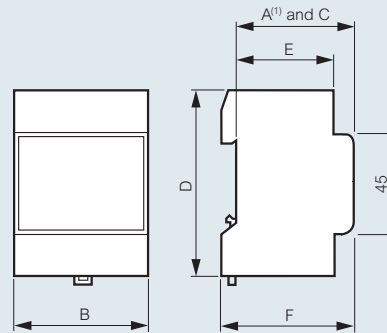

Description	Dimension (mm)					
	A ⁽¹⁾	B	C	D	E	F
Ammeter - Voltmeters	60	70	60	83	44	66
Selector switches	69	52.5	60	74	44.5	74
Digital frequency meter Cat. No. 0046 64	63	70	63	89	42	69
Three phase meters Cat. No. 0046 73/74	60	72	60	81	44	66
Single phase meters Cat. No. 0046 81/72	60	35.5	60	89	44	66

(1) Maximum projection

modular fuse carriers

for industrial cylindrical cartridge fuses

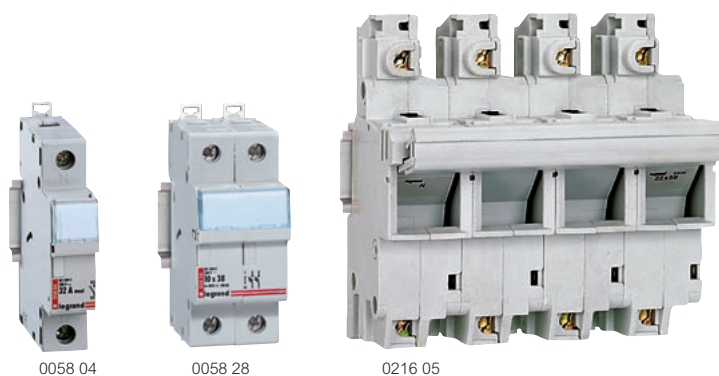

Dimensions (opposite)
Accessories (p. 90)

For HRC cylindrical fuses (see p. 91)

Pack	Cat. Nos.	Modular carriers for HRC type aM and gG fuses	
		Conform to IEC 60269-2/2-1, isolation to IEC 60947-3 Fix to DIN rail EN 60715 Equipped with label holder Padlockable using locking accessory Cat. No. 0057 99, p. 90 Shielded terminals max. capacity 2 x 10 mm ² Double insulated Class II	
		Fuse size (mm)	Voltage ~ (Volts)
			No. of 17.5 mm modules
		Single pole	
10	0058 04	Disconnectable neutral	500
10	0058 06	8.5 x 31.5	400
10	0058 08	10 x 38	500
		Single pole + Neutral	
10	0058 16	8.5 x 31.5	400
10	0058 18	10 x 38	500
		Double pole	
5	0058 28	10 x 38	500
		Triple pole	
3	0058 38	10 x 38	500
		Triple pole + Neutral	
2	0058 48	10 x 38	500

		SP fuse carriers	
		Conform to IEC 60269-2 and BS EN 60269-2 Bureau Veritas approved Height under front plate : 44 mm Fix to DIN rail EN 60715 or with screws	
		SP 51 for HRC type aM and gG fuses 14 x 51	
		Connection	No. of 17.5 mm modules
5	0215 01	Single pole	1.5
1	0215 03	Double pole	3
1	0215 04	Triple pole	4.5
1	0215 05	Triple pole + disconnectable neutral	6
		SP 58 for HRC type aM and gG fuses 22 x 58	
		Connection	No. of 17.5 mm modules
3	0216 00	Disconnectable neutral	2
3	0216 01	Single pole	2
1	0216 04	Triple pole	6
1	0216 05	Triple pole + disconnectable neutral	8

modular fuse carriers

for industrial cylindrical cartridge fuses

Modular fuse carriers

Conform to IEC 60269-2/2-1, isolation to IEC 60947-3
Icc : 20 kA with 8.5 x 31.5 fuse
100 kA with 10 x 38 fuse
Operating temperature : -5 °C to +40 °C
Mechanical resistance : IPxx 3

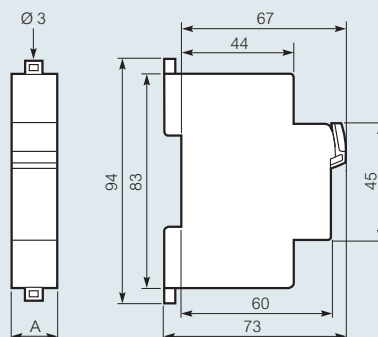

In mm	A
Single pole	17.7
Single pole + N	17.7
Double pole	35.5
Triple pole	53.4
Triple pole + N	71.2

SP 51 and SP 58 fuse carriers

Conform to IEC 60269-2 and BS EN 60269-2
Bureau Veritas approved

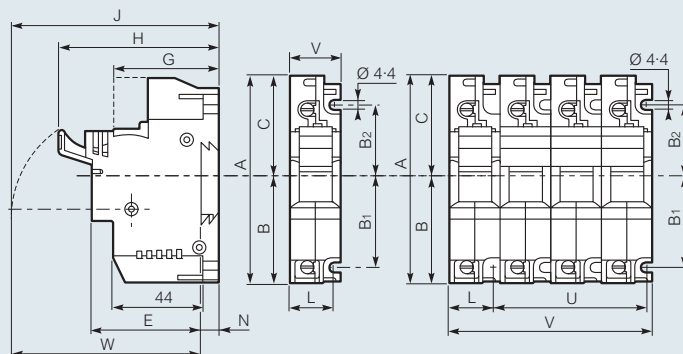

In mm	A	B	B ₁	B ₂	C	E	G	H 1 P	H multi.	J 1 P
SP 51	106	54.5	45	35	51.5	55	53	81	84	96
SP 58	140	74	65	45	66	59	53	87	90	111

In mm	J multi.	L	N	U 2 P	U 3 P	U 4 P	V 1 P	V 2 P	V 3 P	V 4 P	W 1 P	W multi.
SP 51	99	20.7	9	26.5	53	79.5	26.5	53	79.5	106	87	90
SP 58	114	27	9	36	72	108	36	72	108	144	101	109

Choice of equipment

Type	Rated current	Maximum cartridge rating			
		400 V ~		500 V ~	
		gG	aM	gG	aM
SP 51	50 A	50	50	50	40
SP 58	100 A (125 A in 400 V)	125	125	100	50

Protection index : IP 2x - IP 2x C - under front plate

Equipment derating

Justified under more severe conditions of use :

- Ambient temperature over 35 °C : derate fuse by one rating per 10 °C (UTE C 20-051)
- Side-by-side equipment in simultaneous function

2 or 3 devices	0.9 x I _n
4 or 5 devices	0.8 x I _n
6, 7, 8 or 9 devices	0.7 x I _n
≥ 10 devices	0.6 x I _n

This coefficient is to be applied on the nominal rating of the base (IEC 60439-1)
Continuous operation : it may be necessary to upgrade the bases by one size

Modular protective terminal shield mounting

(see p. 90)

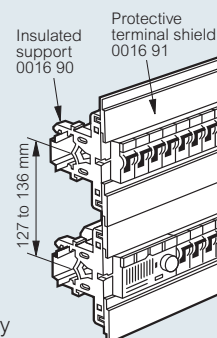

modular fuse carrier and device accessories



0044 40



0049 05



0049 26



0016 91



0016 90

Pack	Cat. Nos.	Modular fuse carrier accessory
3	0057 99	Padlock support suitable for Ø5 mm padlocks

Modular device accessories		
Spacing elements		
10	0044 40	For heat reduction - 0.5 module
5	0044 41	For heat reduction - 1 module
Locking device		
2	0044 42	Attachment for Ø 5 mm and Ø 6 mm padlocks for DX-H and DX-D
Padlock		
3	0044 43	Ø 5 mm
Entry terminals		
20	0049 05	Accepts conductors 4 - 25 mm ² max for single pole busbars only IP 2x
20	0049 06	Accepts conductors 6 - 35 mm ² max
Supply busbars		
20	0049 26	For 13 single pole units ⁽¹⁾ Reversible blue/black
10	0049 37	For 57 single pole units ⁽¹⁾ Reversible blue/black
5	0049 38	For 6 double pole units ⁽²⁾⁽³⁾
10	0049 39	For 28 double pole units ⁽²⁾⁽³⁾
5	0049 42	For 4 triple pole units ⁽²⁾⁽³⁾
10	0049 43	For 19 triple pole units ⁽²⁾⁽³⁾
3	0049 44	For 3 four pole units ⁽²⁾⁽³⁾
Insulation shroud		
20	0049 88	For non-utilised busbar prongs
Self-adhesive label holder		
10	0049 96	Width : 16 mm Width available for marking : 12 mm Length 430 mm (24 modules)
Grey blanking plate RAL 7035		
10	0016 65	18 module, blanking strip



0044 41



0044 42



0044 43



0049 06

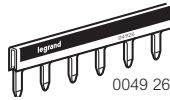

0049 26

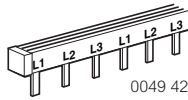

0049 42

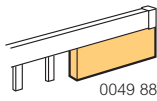

0049 88



0049 96

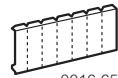

0016 65

Pack	Cat. Nos.	Modular device accessories (continued)
Protective terminal shield		
5	0016 91	Light grey Ensures the protection of wiring and terminals in modular mechanisms fitted in enclosures (Atlantic or Marina) Width 45 mm, Length 1 m Clips on to support 0016 90 (below)
Insulated support		
10	0016 90	For protective terminal shield Clips on to rail EN 60715



For DX MCBs

see p. 79



For enclosures

see p. 14-23

(1) 16 mm² section rated at 80 A with central feed
 (2) 10 mm² section rated at 63 A with central feed
 (3) With insulated ends

cylindrical cartridge fuses

HRC



Dimensions (p. 95)

Pack	Cat. Nos.	Miniature type 5 x 20		
		Type F (fast acting) fuse Ceramic body Conform to IEC 60127-2 For use with transformers (see p. 106), Viking 3 terminals (see p. 132) etc.		
		Rating (Amps)	Voltage ~ (Volts)	Breaking capacity (Amps)
10	0102 02	0.2		
10	0102 05	0.5		
10	0102 06	0.63		
10	0102 10	1		
10	0102 12	1.25		
10	0102 16	1.6		
10	0102 20	2	250	1 500
10	0102 25	2.5		
10	0102 30	3.15		
10	0102 50	5		
10	0102 63	6.3		
10	0102 96 ⁽¹⁾	10	250	500

Pack	Cat. Nos.	Type gG		
		Conform to BS EN 60269-1, IEC 60269-1 Bureau Veritas approved		
		Rating (Amps)	Voltage ~ (Volts)	Breaking capacity (Amps)
		8 x 32		
10	0123 01	1		
10	0123 02	2		
10	0123 04	4		
10	0123 06	6		
10	0123 08	8	400	20 000
10	0123 10	10		
10	0123 12	12		
10	0123 16	16		

Pack	Cat. Nos.	Type gG industrial		
		HRC (high rupturing capacity) Conform to BS EN 60269-1 and 2 (BS 88) IEC 60269-1, 2 and 2-1 Bureau Veritas approved		
		Rating (Amps)	Voltage ~ (Volts)	Breaking capacity (Amps)
		10 x 38		
		Without indicator		
10	0133 94	0.5		
10	0133 01	1		
10	0133 02	2		
10	0133 04	4		
10	0133 06	6	500	100 000
10	0133 08	8		
10	0133 10	10		
10	0133 12	12		
10	0133 16	16		
10	0133 20	20		
10	0133 25	25		
		14 x 51		
		Without striker		
10	0143 02	2		
10	0143 04	4		
10	0143 06	6		
10	0143 10	10		
10	0143 16	16	500	100 000
10	0143 20	20		
10	0143 25	25		
10	0143 32	32		
10	0143 40	40		
10	0143 50	50		
		22 x 58		
		Without striker		
10	0153 10	10		
10	0153 16	16		
10	0153 20	20		
10	0153 25	25	500	100 000
10	0153 32	32		
10	0153 40	40		
10	0153 50	50		
10	0153 63	63		
10	0153 80	80		
10	0153 96	100		
10	0153 97	125	400	

Pack	Cat. Nos.	Neutral links	
10	0123 00	8 x 32	
10	0133 00	10 x 38	
10	0143 00	14 x 51	
10	0153 00	22 x 58	

Note : Numbers refer to physical size of fuse i.e. 10 x 38 means Ø 10 mm x 38 mm length

**Fuses with strikers are available on special request in specific ratings
Minimum pack quantities apply**

For other ratings and types

Contact us on +44 (0) 845 605 4333

**With a high breaking capacity
to suit industrial applications**

(1) Overrating not described by standards

cylindrical cartridge fuses

HRC (continued)

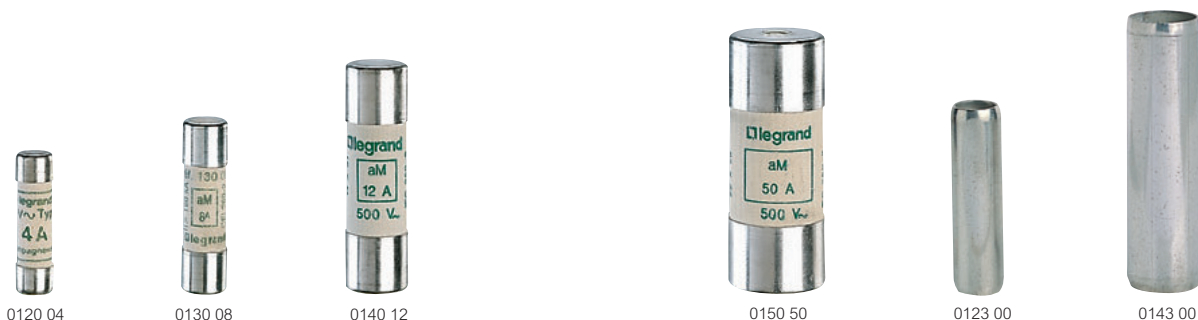

Dimensions (p. 95)

Pack	Cat. Nos.	Cylindrical type aM (motor rated)		
		Conform to BS EN 60269-1 (BS 88) IEC 60269-1 Bureau Veritas approved		
		Rating (Amps)	Voltage ~ (Volts)	Breaking capacity (Amps)
	Without indicator	8 x 32		
10	0120 02	2		
10	0120 04	4	400	20 000
10	0120 06	6		
10	0120 10	10		
		HRC (high rupturing capacity) Conform to BS EN 60269-1 and IEC 60269-1, 2 and 2-1 Bureau Veritas approved		
	Without indicator	10 x 38 HRC		
10	0130 95	0.5		
10	0130 01	1		
10	0130 02	2		
10	0130 04	4		
10	0130 06	6	500	100 000
10	0130 08	8		
10	0130 10	10		
10	0130 12	12		
10	0130 16	16		
10	0130 20 ⁽¹⁾	20	400	
10	0130 25 ⁽¹⁾	25	400	
	Without striker	14 x 51 HRC		
10	0140 04	4		
10	0140 06	6		
10	0140 10	10		
10	0140 12	12	500	100 000
10	0140 16	16		
10	0140 20	20		
10	0140 25	25		
10	0140 32	32		
10	0140 40	40		
10	0140 45	45	400	
10	0140 50	50	400	

Pack	Cat. Nos.	Cylindrical type aM (motor rated) (continued)		
		HRC (high rupturing capacity) Conform to BS EN 60269-1 (BS 88) IEC 60269-1, 2 and 2-1 Bureau Veritas approved		
		Rating (Amps)	Voltage ~ (Volts)	Breaking capacity (Amps)
	Without striker	22 x 58 HRC		
10	0150 32	32	500	100 000
10	0150 40	40		
10	0150 50	50		
10	0150 63	63		
10	0150 80	80		
10	0150 96	100		
10	0150 97	125	400	
		Neutral links		
10	0123 00	8 x 32		
10	0133 00	10 x 38		
10	0143 00	14 x 51		
10	0153 00	22 x 58		

Note : Numbers refer to physical size of fuse i.e. 10 x 38 means Ø 10 mm x 38 mm length

For other ratings and types

Contact us on +44 (0) 845 605 4333

(1) Overtopping not described by standards

HRC blade type cartridge fuses

gG/aM type



Dimensions (p. 95)

Pack	Cat. Nos.	Type gG (IEC)/gL (VDE)		
		HRC (high rupturing capacity) Conform to BS EN 60269-1 and 2, IEC 60269-1,2 and 2-1, VDE 0636-21 Bureau Veritas approved Fully insulated end plate and handle lugs		
	With indicator	Rating (Amps)	Voltage ~ (Volts)	Breaking capacity (Amps)
	Size 00			
10	0163 18	25	500	120 000
10	0163 20	32		
10	0163 25	40		
10	0163 30	50		
10	0163 35	63		
10	0163 40	80		
10	0163 45	100		
10	0163 50	125		
10	0163 55	160		
	Size 0			
3	0168 45	100	500	120 000
3	0168 50	125		
3	0168 55	160		
3	0168 60 ⁽¹⁾	200		
	Size 1			
3	0173 50	125	500	120 000
3	0173 55	160		
3	0173 60	200		
3	0173 65	250		
	Size 2			
3	0178 60	200	500	120 000
3	0178 65	250		
3	0178 70	315		
3	0178 75	400		

Pack	Cat. Nos.	Type aM (motor rated)		
		HRC (high rupturing capacity) Conform to BS EN 60269-1 and 2, IEC 60269-1,2 and 2-1, VDE 0636-21 Bureau Veritas approved Fully insulated end plate and handle lugs		
	With indicator	Rating (Amps)	Voltage ~ (Volts)	Breaking capacity (Amps)
	Size 00			
3	0160 25	40		
3	0160 30	50		
3	0160 35	63		
3	0160 40	80		
3	0160 45	100	400	
3	0160 50	125		
	Size 0			
3	0165 35	63	500	120 000
3	0165 40	80		
3	0165 45	100		
3	0165 50	125		
3	0165 55	160		
	Size 1			
3	0170 50	125	500	120 000
3	0170 55	160		
3	0170 60	200		
3	0170 65	250		
	Size 2			
3	0175 60	200	500	120 000
3	0175 65	250		
3	0175 70	315		

Pack	Cat. Nos.	Neutral blades
1	0168 04	Size 0
1	0173 04	Size 1
1	0178 04	Size 2
1	0181 04	Size 3

(1) Overrating not described by standards

blade type cartridge fuse accessories

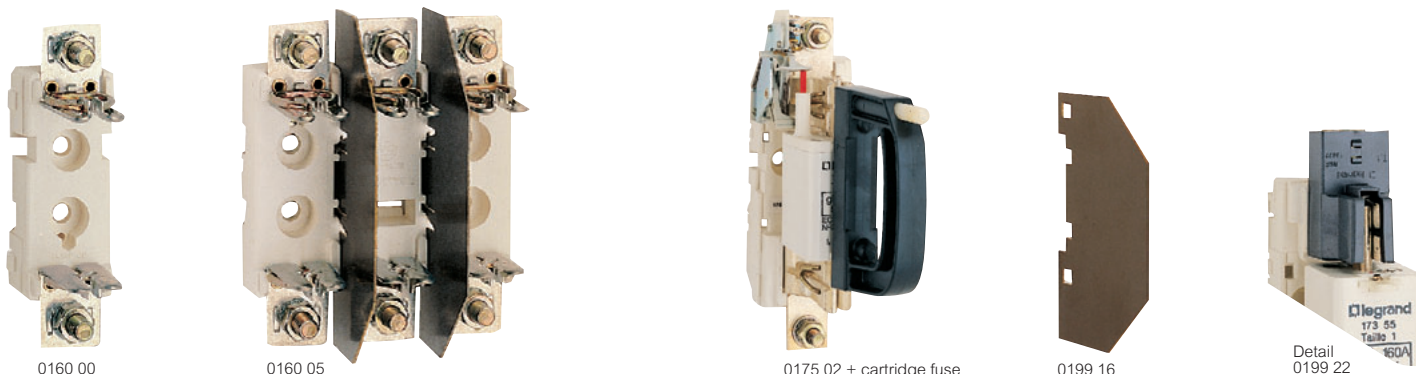

Dimensions (p. 95)

Pack	Cat. Nos.		Bases for blade type cartridge fuses		
			Conform to BS EN 60269-1 and 2, IEC 60269-1,2 and 2-1, VDE 0636-21 Bureau Veritas approved		
			Triple pole bases supplied with 2 dividers		
			Contact points are sprung		
			Bases with 10 A – 250 V \sim micro-switch have a "cartridge present" signalling device for fuses with standardised striker		
			Size 00 – 100 A		
	Single pole	Triple pole	Bases	Mounting	Connection
3	0160 00		bare	screw	
1		0160 04	bare	screw	
3	0160 01		bare	└ rail	M8
1		0160 05	bare	└ rail	
			Size 00 – 160 A		
3	0162 00		bare	screw	M8
1		0162 04	bare	screw	M8
			Size 0 – 160 A		
3	0165 00		bare	screw or	
1		0165 03	bare	└ rail	M8
3	0165 02		with micro-switch	└ rail	
			Size 1 – 250 A		
3	0170 00		bare	screw or	
1		0170 03	bare	└ rail	M10
1	0170 02		with micro-switch	└ rail	
			Size 2 – 400 A		
3	0175 00		bare	screw or	
1		0175 03	bare	└ rail	M10
1	0175 02		with micro-switch	└ rail	

Pack	Cat. Nos.	Accessories for blade type cartridge fuses
		Handle
5	0199 02	Removable handle for all sizes
		Separation dividers
10	0199 09	Size 00 (for Cat. Nos. 0160 00/01 and Cat. No. 0162 00)
10	0199 15	Size 0
10	0199 16	Size 1
10	0199 17	Size 2
		Terminal shields
		For enhanced protection of blade type cartridge fuse bases
10	0199 20	Size 00
10	0199 21	Size 0
10	0199 22	Size 1
10	0199 23	Size 2

cartridge fuses

dimensions

■ Cylindrical fuses (p. 91-92)

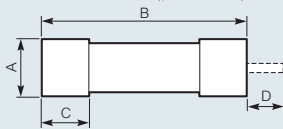

Size	A	B	C	D
8 x 32 (mm)	8.5	31.5	6.3	-
10 x 38 (mm)	10.3	38	10	-
14 x 51 (mm)	14.3	51	13	7.5
22 x 58 (mm)	22.2	58	16	7.5

■ Blade type fuses (p. 93)

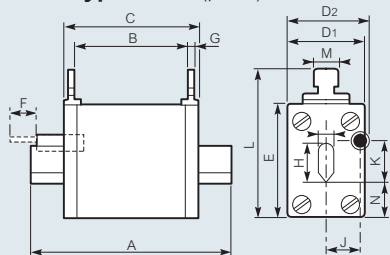

Size	00	0	1	2
A (mm)	78	125	135	150
B (mm)	44	62	64	64
C (mm)	52	67	74	74
D ₁ (mm)	30	36	47	50
D ₂ (mm)	-	39	47	50
E (mm)	46	46	52	60
F (mm)	-	14	14	14
G (mm)	2.5	2.5	3	3
H (mm)	15	15	21	28
I (mm)	6	6	6	6
J (mm)	-	14.5	16	19
K (mm)	-	14.5	14.5	14.5
L (mm)	59	59	64	72
M (mm)	10	10	10	10
N (mm)	14.5	14.5	14.5	14.5

■ Neutral blades (p. 93)

Sizes 0 to 3

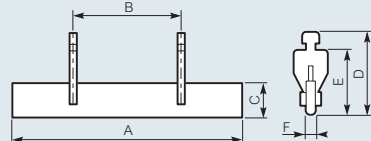

Size	0	1	2	3
A (mm)	125	135	150	150
B (mm)	65	65	65	65
C (mm)	15	20	26	38
D (mm)	45	50	58	66.5
E (mm)	35	40	48	56.5
F (mm)	6	6	6	6

■ Micro-switch 10 A – 250 V~

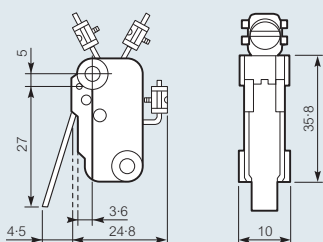

■ Bases for blade type fuses (p. 94)

Bare

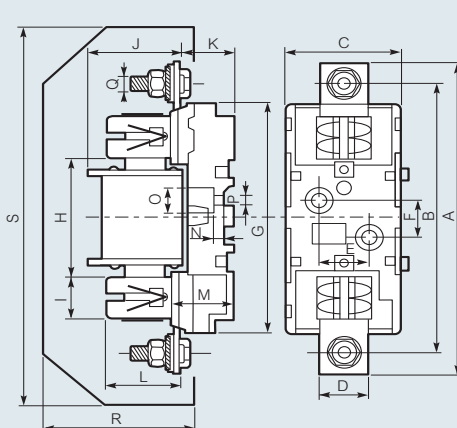

Size	00	0	1	2
A (mm)	120	171	200	225
B (mm)	100	150	175	200
C (mm)	36	47	59	67
D (mm)	24	20	25	30
E (mm)	-	-	30	30
F (mm)	25	25	25	25
G (mm)	120	125	150	170
H (mm)	57	75	80	80
I (mm)	11	23	28	32
J (mm)	63	68	68	83
K (mm)	20	24	35	35
L (mm)	35	43	46	58
M (mm)	22.5	28	38	39
N (mm)	12	11.5	13.5	13.5
O (mm)	15	14	20	20
P (mm)	7	7.5	10.5	10.5
Q (mm)	8	8	10	10
R (mm)	84	96	107	121
S (mm)	125	180	224	240

■ Size 00 fixing on rail (p. 94)

Single pole

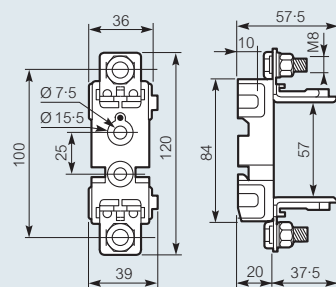

Triple pole

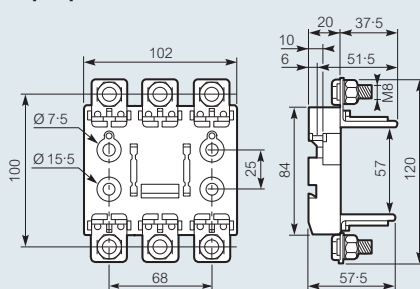

■ With micro-switch (p. 94)

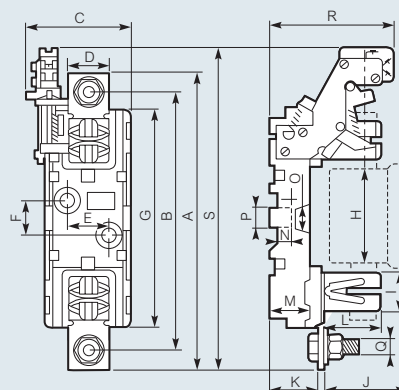

Size	0	1	2
A (mm)	171	200	225
B (mm)	150	175	200
C (mm)	63	72	78
D (mm)	20	25	30
E (mm)	-	30	30
F (mm)	25	25	25
G (mm)	125	150	170
H (mm)	75	80	80
I (mm)	23	28	32
J (mm)	68	68	83
K (mm)	24	35	35
L (mm)	43	46	58
M (mm)	28	38	39
N (mm)	11.5	13.5	13.5
O (mm)	14	20	20
P (mm)	7.5	10.5	10.5
Q (mm)	8	10	10
R (mm)	75	85	90
S (mm)	198	215	229

Triple pole (p. 94)

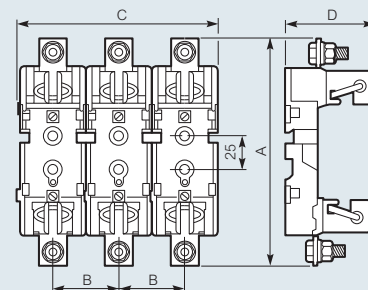

Size	0	1	2
A (mm)	171	200	225
B (mm)	48	62.5	68
C (mm)	144	180	204
D (mm)	67	81	93

■ Removable handle (p. 94)

For sizes 00 - 0 - 1 - 2

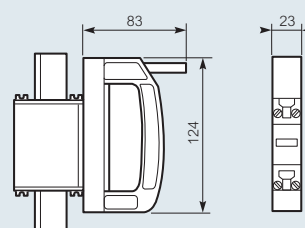

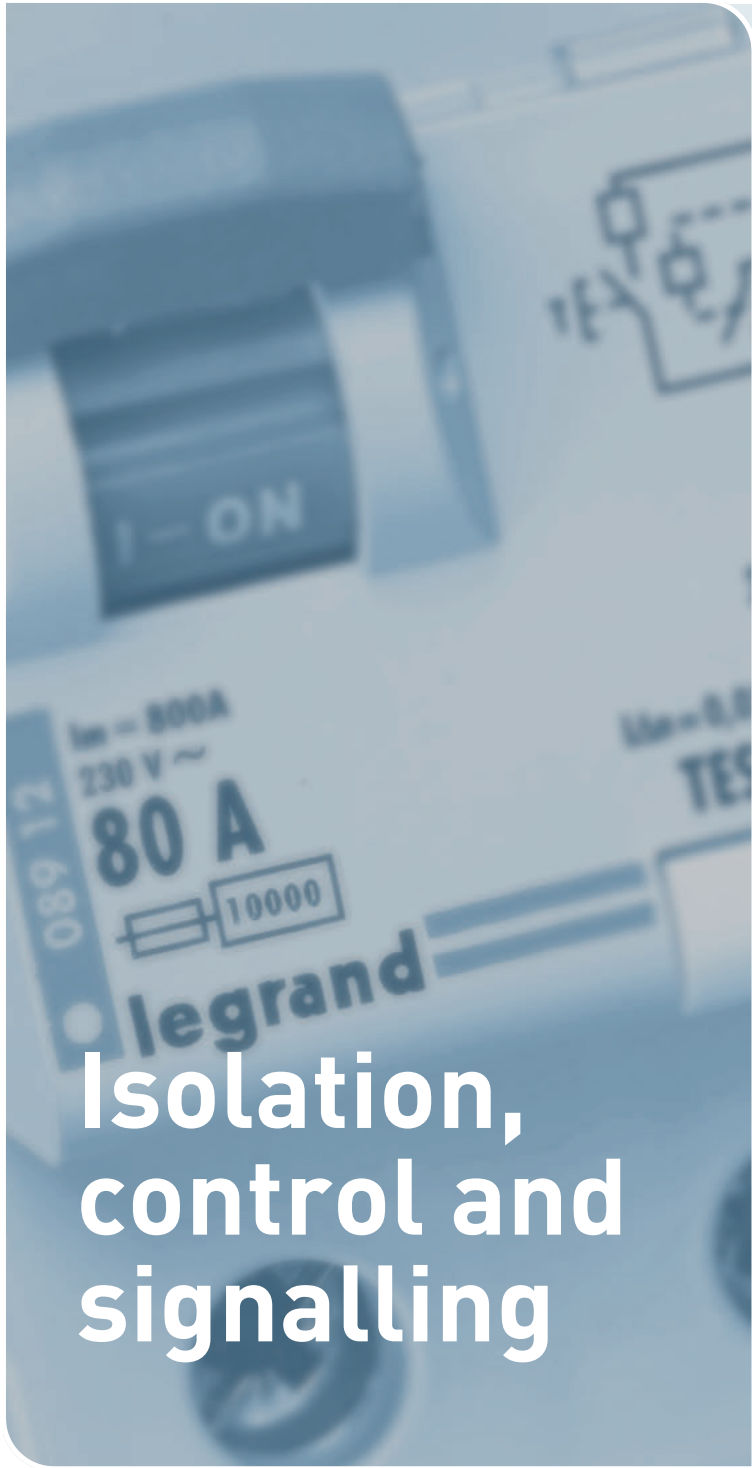

Isolation, control and signalling

Isolating and
changeover
switches



P. 100
Isolating
switches
16 to 125 A

Transformers

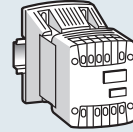

P. 106
Control,
signalling and
safety isolation
transformers

Power supplies

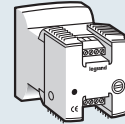

P. 112
Filtered
power supplies

Signalling



P. 114
Power
contactors

Time switches
and light control
switches



P. 120 NEW
AlphaRex³
programmable
digital for rail

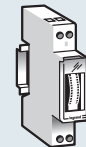

P. 125 NEW
MicroRex
analogue for
rail

NEW IN 2012



**AlphaRex³ and
AlphaRex³ Astro
time switches**
digital for rail

(p. 120)



**MicroRex D Plus
time switches**
digital for rail

(p. 123)

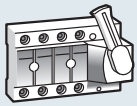

P. 101
Vistop
isolating switches
63 to 160 A



P. 102
Vistop
technical
information

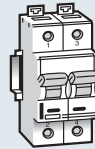

P. 103
Changeover
switches



P. 103
Changeover
switches technical
information



P. 107
Control transformers
dimensions
and electrical
characteristics

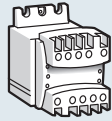

P. 108 NEW
Compact
transformers



P. 109
Compact transformers
dimensions
and electrical
characteristics



P. 110
How to calculate
rated power
and transformer
protection



P. 112
Filtered
power supplies
technical
information



P. 113
Filtered
power supplies
electrical
characteristics



P. 115
Power contactors
technical
information

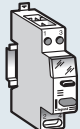

P. 116
Push buttons/
control switches
and indicators

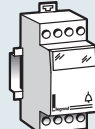

P. 116 NEW
Transformers
and buzzers



P. 117
Modular DIN
rail equipment
dimensions



P. 120 NEW
AlphaRex³ Astro
programmable
digital for rail



P. 123 NEW
MicroRex D Plus
digital for rail



P. 123
MicroRex D
digital for rail

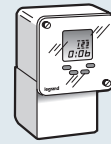

P. 124
MaxiRex
digital surface or
panel mounting

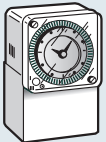

P. 126
MaxiRex
analogue
surface and
panel mounting

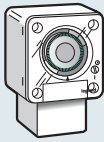

P. 126 NEW
EconoRex
analogue
surface and
panel mounting

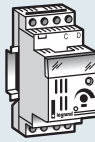

P. 127
MicroLux D
light sensitive
switch
digital for rail

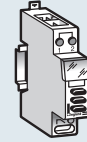

P. 127 NEW
Electronic
time-lag switch
digital for rail



MicroRex
time switches
analogue for rail
[\(p. 125\)](#)



EconoRex
time switch
analogue surface
and panel mounting
[\(p. 126\)](#)

Isolation, control and signalling

Legrand's extensive range of DIN rail mounted equipment for isolation, control and signalling covers everything you need from isolating and changeover switches, transformers and power supplies to power contactors and time switches.

DIN rail mounting protection devices are also available, (see p. 54 to 95).

ISOLATING SWITCHES

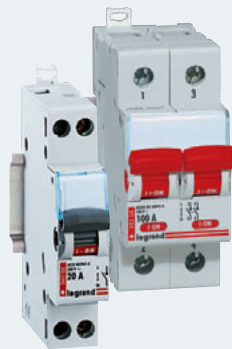

FEATURES -

- Double break contacts
- Visible contact indicator
- Standard isolating switches and Vistop options available (see below)

TECH DATA (standard range) -

Breaking capacity: AC 22A
 Current rating: 16A to 125A
 Rated voltage: 250V / 400V

CHANGEOVER SWITCHES

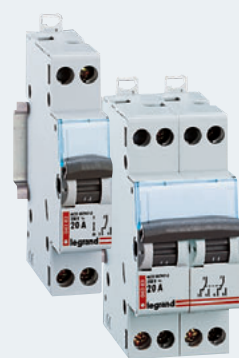

FEATURES -

- Locking accessories available
- Two way, double two way and two way with centre point options

TECH DATA -

Breaking capacity: AC 22A
 Nominal rating: 20A
 Rated voltage: 250V



Vistop isolating switches

Combine isolation with load breaking in one unit with Vistop isolating switches... available in 4 current ratings, from 63A to 160A, Vistop boasts a double break switch to reduce arcing, and can be equipped with a full range of range of accessories and a choice of front, side or external handles, (see p. 101).

TECH DATA -

Breaking capacity: 15kA
 Current rating: 63A to 160A
 Rated voltage: 250V

TRANSFORMERS & POWER SUPPLIES

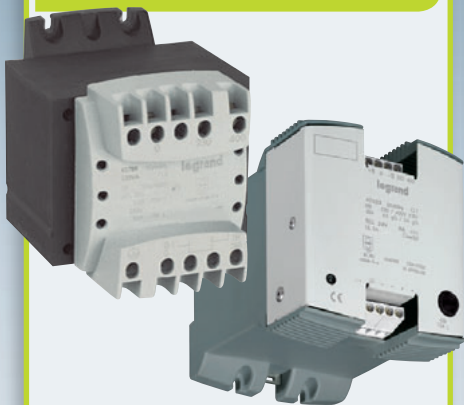

FEATURES -

- Control, signalling and safety isolation transformers
- Compact transformers
- Filtered power supplies

For further information see p. 104 to 113

POWER CONTACTORS



FEATURES -

- Contact choice: N/O - normally open
N/C - normally closed
- Easy fixing of control and auxiliaries ensures optimum strength
- Ergonomic design - easy identification of handle position
- Independent screw connection / wiring of control and power terminals at any one time

TIME SWITCHES



FEATURES -

- Digital and analogue options
- DIN rail and surface mounting options
- NEW AlphaRex[®] programmable range

For further information see p. 118 to 127

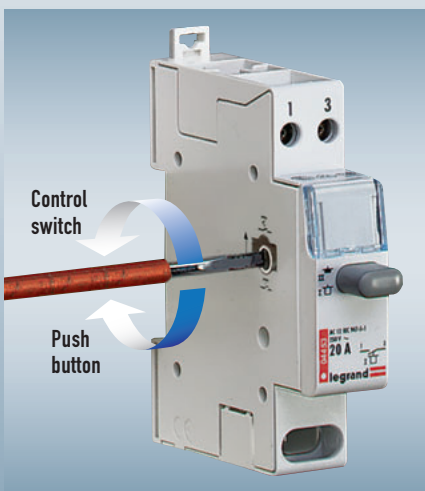

It's a push button, it's a control switch... you decide

Turn a momentary contact into a maintained contact at the turn of a button with Legrand's versatile push button / control switches.

Available with normally open (N/O), normally closed (N/C) or both N/O and N/C contacts, and in single function or dual function with indicators.

See p. 116

isolating switches

16 to 125 A



0043 22



0043 36



0043 55



0043 74

Dimensions (p. 117)

Conform to IEC 60669-1
 Breaking capacity AC 22 A according to BS EN 60947-3
 Double break contacts
 Visible contact indicator

Pack	Cat. Nos.	Isolating switches	Nominal rating (A)	Number of 17.5 mm modules
		Single pole - 250 V~		
10	0043 01		16	1
10	0043 02		20	1
10	0043 05		32	1
10	0043 07		40	1
10	0043 10		63	1
5	0043 14	100	1	
		Double pole - 400 V~		
10	0043 21		16	1
10	0043 22		20	1
10	0043 25		32	1
5	0043 27		40	2
5	0043 30		63	2
5	0043 31		63 with red handle	2
5	0043 34		100	2
2	0043 38		125	2

Pack	Cat. Nos.	Isolating switches (continued)	Nominal rating (A)	Number of 17.5 mm modules
		Double pole with indicator - 400 V~		
		Supplied with lamp		
10	0043 23		20	1
10	0043 26		32	1
		Triple pole - 400 V~		
5	0043 42		20	2
5	0043 45		32	2
3	0043 47		40	3
3	0043 50		63	3
3	0043 54		100	3
3	0043 55		100 with red handle	3
3	0043 58		125	3
			Four pole - 400 V~	
5	0043 62		20	2
5	0043 65		32	2
2	0043 67		40	4
2	0043 70		63	4
2	0043 74		100	4
2	0043 75		100 with red handle	4
2	0043 78		125	4

Pack	Cat. Nos.	Accessories
2	0044 42	Locking device Attachment for Ø 5 mm padlock
3	0044 43	Padlock Ø 5 mm
2	0044 44	Sealable screw cover 4 separate poles
6	0044 47	Insulating shield Insulating shield

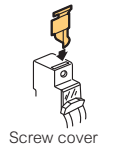
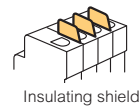

Vistop™ isolating switches

63 to 160 A



0225 15

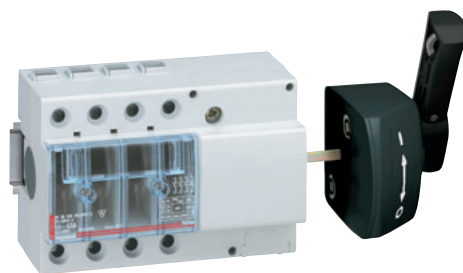

0225 18

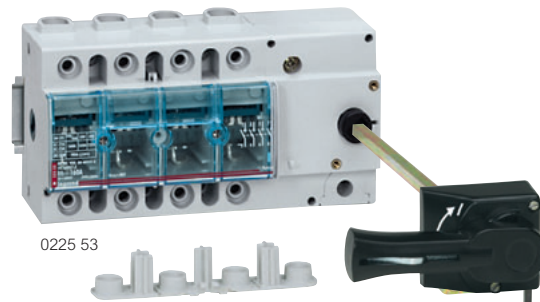

0225 53



0227 98



0227 32

Dimensions and technical information (p. 102)

Conform to BS EN 60947-3
 Bureau Veritas approved
 Safety switches for on-load circuit breaking by visible isolation of the contacts
 Double break type load switching with self cleaning contacts by rapid make and break movements
 Fixing on rail EN 60715 or screw fixing (only on rail for Vistop 63 A)
 2 versions for mounting on faceplate :

- **left or right side handle**, supplied with seal to maintain the IP protection of the enclosure (up to IP 55), screws, self adhesive drilling template, extension rod (30 to 170 mm) for creating an external angle
- **direct front handle or external handle** with Cat. No. 0227 32

Vistop isolating switches with black handle - 63 to 160 A

Pack	Cat. Nos.			Connection	Number of 17.5 mm modules
1	Front handle	Side handle	63 A	Cage terminals	7
	0225 12	0225 16			
1	0225 15	0225 18	100 A	Key	7.5
	0225 20	0225 25			
1	0225 22	0225 27	125 A	6 sides	9
	0225 34	0225 44			
1	0225 39	0225 46	160 A	Key	7.5
	0225 51	0225 54			
1	0225 53	0225 56	160 A	6 sides	9

Possibility to add auxiliary contact
 Cat. No. 0227 07

Auxiliary isolating switch 2 pole - 16 A - 400 V

Pack	Cat. Nos.		Connection	Number of 17.5 mm modules
1	0227 22	2 P	Cage terminals	1.5

For creating 3 or 4 pole assemblies for simultaneous breaking of 2 pole auxiliary power supply (PLC, remote control), 16 A maximum
 Mounts on the left side of Vistop 100 to 160 A

Sealable terminal shields

1	0227 98	Set of 2 separate, sealable terminal shields Clip on upstream and/or downstream of Vistop 160 A
---	---------	--

Front external handle kit

1	0227 32	Comprising : connection rod, bracket, self-adhesive drilling template, fixing accessories (including a seal to maintain the IP protection of enclosure up to IP 55) and locking mechanism to prevent opening of the door when the circuit is closed Door distance 35 to 470 mm
---	---------	---

Auxiliary switches for on-off signalling IP 2x - 5 A - 250 V

Pack	Cat. Nos.		Connection (mm ²)
1	0227 04	N/O + N/C contact For incorporation in one-piece enclosure Main contact 2 N/C + 2 N/O mounting	lug 2-58
1	0227 07	Additional N/C + N/O auxiliary contact 2 N/C + 2 N/O mounting	

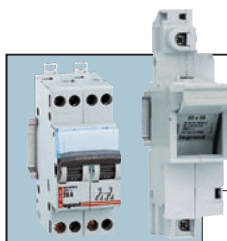

For changeover switches and fuse carriers

see p. 103 and 89

Vistop™ isolating switches

63 to 160 A

Conform to standards BS EN 60947-3, EN / IEC 60947-3, VDE 0660, NBN EN 60947-3, CNOMO E03 - 15-611 R, Bureau Veritas approved Glass fibre reinforced insulating casing, self-extinguishing at 960 °C (IEC EN 60695-2-1)
Handle can be padlocked in open position using 1 to 3 padlocks Ø6 mm

Electrical characteristics

Thermal rating (I _{th})	63 A	100 A	125 A	160 A	
Terminals	cage	cage	cage	cage	
Connection	Cu (flexible)	4 to 35 ²			
	Cu (rigid)	4 to 50 ²			
Insulating voltage (U _i)	690 V~	800 V~	800 V~	800 V~	
Impulse resistant voltage (U _{imp})	8 kV	8 kV	8 kV	8 kV	
AC 22 A ⁽¹⁾	400 V	63 A (35 kW)	100 A (55 kW)	125 A (70 kW)	160 A (88 kW)
	500 V	63 A (44 kW)	100 A (69 kW)	125 A (87 kW)	160 A (110 kW)
AC 23 A ⁽¹⁾	690 V	40 A (38 kW)	100 A (96 kW)	125 A (120 kW)	125 A (120 kW)
DC 22 A/250 V ⁽¹⁾⁽²⁾	63	100	125	125	
DC 23 A/250 V ⁽¹⁾⁽²⁾	63	100	125	125	
Breaking capacity (I _{cu}) (kA peak)	15	15	15	15	
1 s resistant current (I _{cw}) (kA rms)	2.5	3.5	3.5	3.5	
I _{cc} with fuses (kA rating)	100	100	100	80	
Fuse rupture capacity	63 A	100 A (gG) 63 A (aM) ⁽³⁾	125 A (gG) 125 A (aM) ⁽³⁾	160 A (gG) 125 A (aM)	
Short circuit capacity (I _{cm}) (kA prospective peak)	7	12	12	12	
Mechanical endurance (No. of operations)	> 30000	> 30000	> 30000	> 30000	
Index of protection	IP 2x B (IP 3x C under front plates) from 6 mm ²	IP 2x B (IP 3x C under front plate) from 10 mm ²			

(1) Test according to IEC 60947-3
AC 22 A / DC 22 A: resistive motor breaking
AC 23 A / DC 23 A: inductive motor breaking
(2) No of breaking contacts: 2
(3) 100 A (aM) with blade type cartridge fuses

Example of mounting with Vistop 100 to 160 A

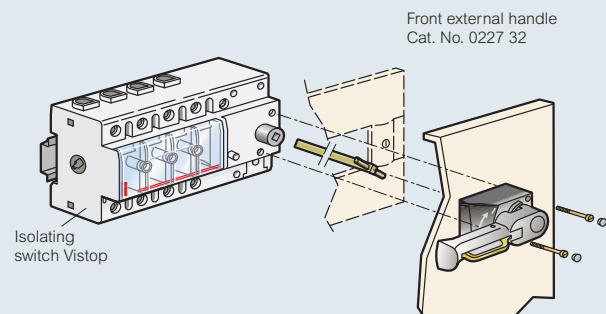

Dimensions

Front handle

- 63 to 160 A
- Direct

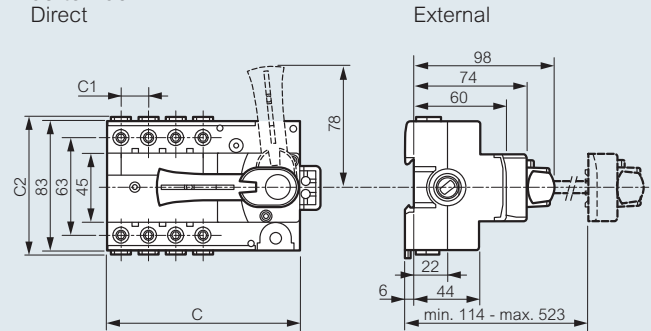

	Front handle		
	63 A 3P and 4P	100 A, 125 A, 160 A 3P	4P
C	125	133	160
C ₁	17.7	26.7	
C ₂	90	91	

Side handle

- 63 to 160 A

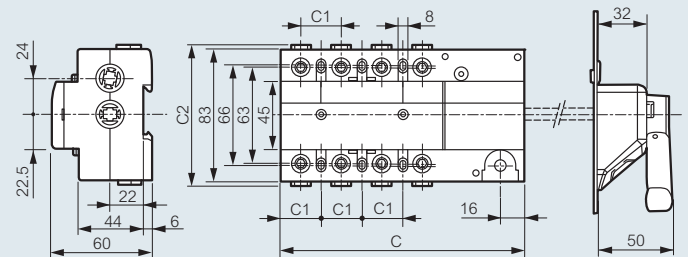

	External side handle		
	63 A 3P and 4P	100 A, 125 A, 160 A 3P	4P
C	125	133	160
C ₁	17.7	26.7	
C ₂	90	91	

changeover switches



0043 82



0043 83



Dimensions and technical information (opposite)

Pack	Cat. Nos.	Changeover switches	No. of 17.5 mm modules
10	0043 82	Conform to IEC 60669-1 Breaking capacity AC 22 A according to BS EN 60947-3 Nominal rating (A) Two way - 250 V~ 20	1
5	0043 83	Double two way - 400 V~ 20	2
10	0043 85	Two way with centre point - 250 V~ 20	1

Pack	Cat. Nos.	Locking accessories
2	0044 42	Locking device Attachment for Ø 5 mm padlock
3	0044 43	Padlock Ø 5 mm

changeover switches

■ Protection index

Class II \square
 IP 2x protection against direct contact

■ Mechanical characteristics

• **Environmental conditions**
 Operating temperature : -5 °C to +40 °C

■ Dimensions

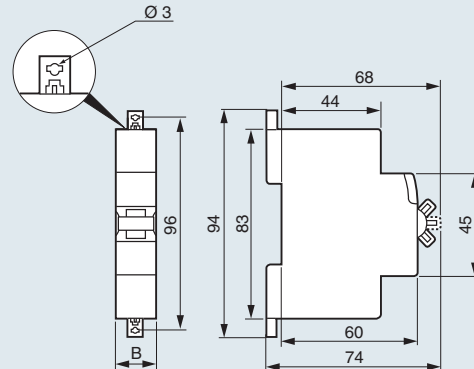

Cat. Nos.	B
0043 82/85	17.7
0043 83	35.6

■ Installation

• Mounting

- on symmetrical rail EN 50-022
- with Ø 3 screw on plate using ends of released claws
- supply via the top or the bottom
- operating position : vertical

• Wiring

Conductors permitted	
Flexible with end caps	1.5 to 4 mm ²
Rigid	1.5 to 4 mm ²
Tools required :	
Flat blade screwdriver	Ø 4 mm
Posidrive screwdriver	Pz 1
Tightening torque	
Min.	0.8 Nm
Max.	1.8 Nm
Recommended	1.2 Nm

Transformers and power supplies...

the reliable choice

Specifically designed to meet the needs of control and signalling, isolation and safety isolation, Legrand's open type single phase transformers are suited to a multitude of applications.

The offer is complemented by a range of filtered power supplies, specifically for 12 or 24 V DC applications.

MEETING THE STANDARDS



CONTROL, SIGNALLING AND ISOLATION TRANSFORMERS



Ideal for heavy automation systems, industrial process systems and complex machinery.

FEATURES

- Primary tapping +/- 15 V
- 40 VA to 4000 VA
- Permanent laser engraved markings
- DIN rail or mounting plate fixing
- Integral electrostatic shield
- Interference/disturbance filter
- Visible terminals ensure safe and reliable connections
- Supplied complete with voltage links

TECHNICAL DATA

APPROVALS: IEC/EN 61558-2-2, IEC/EN 61558-2-4, IEC/EN 61558-2-6, UL, CSA

PROTECTION: IP2X up to 400 A, IK04

OPERATING TEMPERATURE: up to 50° C without derating

RECOMMENDED PROTECTION: via a gG type fuse or by C type circuit breaker

COMPACT TRANSFORMERS

Ideal for standard systems where compact dimensions are a key installation requirement.

NEW Fixed secondary voltage: 24 V range
40 VA to 630 VA, (see p. 108).

FEATURES

- 40 VA to 630 VA
- Noise filtering up to 220 VA
- Permanent laser engraved markings
- Multiple fixing options: standard plate mounting. DIN rail optional
- Visible terminals ensure safe and reliable connections
- Supplied complete with voltage links

TECHNICAL DATA

APPROVALS: IEC/EN 61558-2-4, IEC/EN 61558-2-6

OPERATING TEMPERATURE: up to 35° C without derating

RECOMMENDED PROTECTION: Type T fuses for 40 VA and 63 VA Type C MCBs for 100 VA and greater

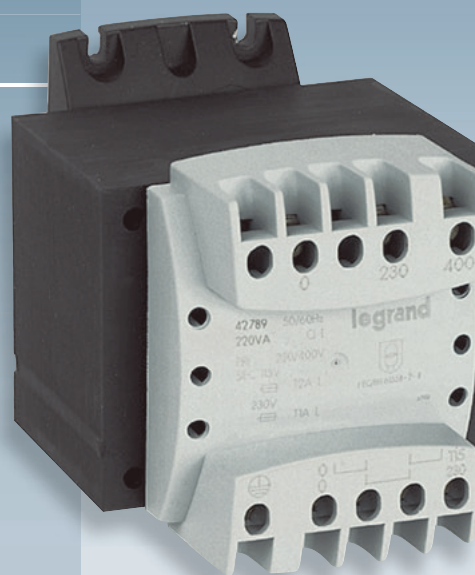

FILTERED POWER SUPPLIES



A range of filtered power supplies for PLCs and other equipment requiring a voltage of 12 V DC or 24 V DC.

FEATURES

- Ripple factor < 3%
- Twin output terminals for ease of connection
- DIN rail or mounting plate fixing
- Noise filtering
- Integrated secondary fuse protection
- Supplied with busbar for quick connection between neutral and earth (up to 15 V)

TECHNICAL DATA

APPROVALS: UL, CSA

OPERATING TEMPERATURE: Up to 60° C without derating

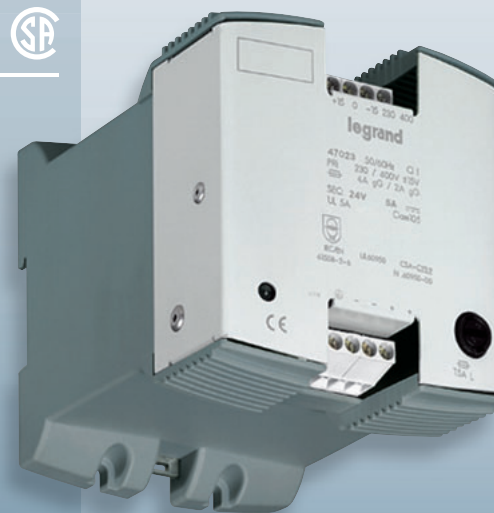

control, signalling and safety isolation transformers

open type single phase



0442 35



0442 68



0442 71

Dimensions and technical information (p. 107)

IP 2x or xxB up to 400 VA
 IP xxA above 400 VA - IK 04
 Conform to IEC/EN 61558-2-2 and 2-4 or 2-6
 UL506 and CSA C22-2-N°66
 Products suitable for building into equipment conforming to EN 61131-2, EN 60204-1 and EN 60439-1 standards
 Insulated covers up to 1 000 VA provided
 Interference/disturbance filter included
 Screw fix to mounting plate or clip on to DIN rail up to 250 VA
 Supplied with 0V/Earth connection link up to 1 000 VA

Single phase

Pack	Cat. Nos.	Power in VA			Admissible instantaneous power at cos φ = 0.5
		according to IEC and CSA	according to UL	according to UL	
1	0442 31	40	40	52	
1	0442 32	63	63	87	
1	0442 33	100	100	150	
1	0442 34	160	140	250	
1	0442 35	250	210	420	
1	0442 36	400	300	900	
1	0442 37	630	500	1 700	
1	0442 38	1 000	700	2 000	
1	0442 39	1 600	700	8 500	
1	0442 40	2 500	1 400	3 300	

Single phase

Pack	Cat. Nos.	Power in VA			Admissible instantaneous power at cos φ = 0.5
		according to IEC and CSA	according to UL	according to UL	
Safety isolating transformers					
Primary : 230-400 V ± 15 V					
Secondary : 115-230 V					
Supplied with 2 links					
1	0442 61	40	40	50	
1	0442 62	63	63	86	
1	0442 63	100	100	150	
1	0442 64	160	140	250	
1	0442 65	250	210	430	
1	0442 66	400	300	1 200	
1	0442 67	630	500	1 600	
1	0442 68	1 000	700	2 000	
1	0442 69	1 600	700	6 100	
1	0442 70	2 500	1 300	7 100	
1	0442 71	4 000	2 400	11 400	

Secondary protection

Transformers can be protected by a gG type fuse or by a C type circuit breaker (p. 91 and 79)

Multiple fixing possibilities

- For DIN rail (p. 26)
- For Lina 12.5 plates (p. 23)
- For Lina 25 plates (p. 23)

For 460 V primary voltage range available for marine applications

Contact us on +44 (0) 845 605 4333

For modular transformers

see p. 116

control, signalling and safety isolation transformers

open type single phase

■ Dimensions

Fig. 1 : 40 to 400 VA

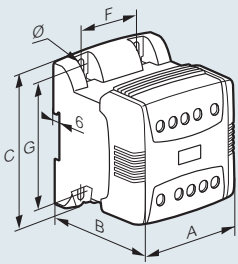

Fig. 2 : 630 to 1 000 VA

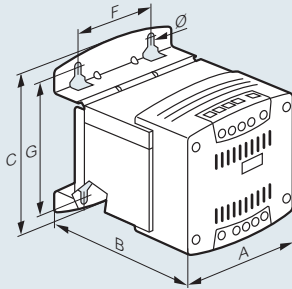

Fig. 3 : 1 600 to 2 500 VA

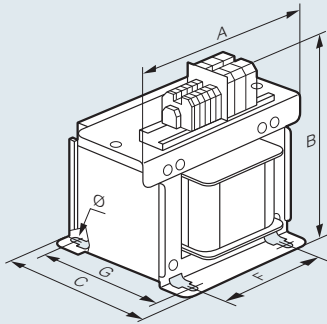
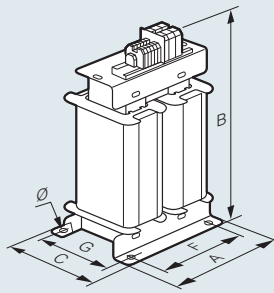
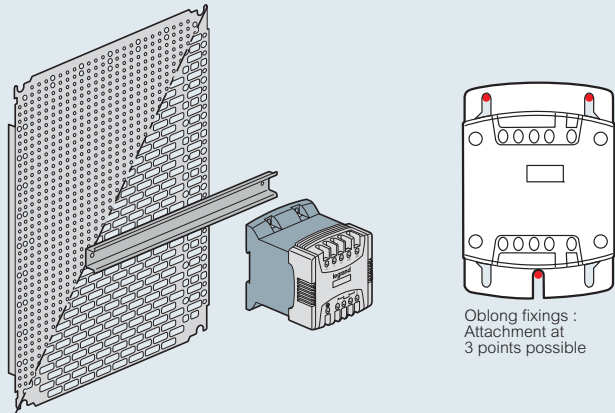

Fig. 4 : 4 000 to 8 000 VA



■ Fixing

On perforated plates Lina 25 and on Lina 12.5 plates, see p. 23
On symmetrical rail up to 250 VA
fixing centres pitch 25 mm up to 1000 VA



Cat. Nos.	Power (VA)	Fig.	Dimensions (mm)			Fixing ⁽¹⁾ (mm)			Weight (Kg)
			A	B	C	F	G	Ø	
0442 31/61	40	1	94	78	113	50	100	5-2	1-23
0442 32/62	63	1	94	85	113	50	100	5-2	1-56
0442 33/63	100	1	94	94	113	50	100	5-2	1-95
0442 34/64	160	1	94	112	113	50	100	5-2	2-6
0442 35/65	250	1	106	123	115	50	100	5-2	3-82
0442 36/66	400	1	120	140	140	62.5	125	5-2	5-62
0442 37/67	630	2	150	158	206	100	175	7	9-9
0442 38/68	1000	2	150	199	206	100	175	7	14-9
0442 39/69	1600	3	220	245	191	150	153	9	25-6
0442 40/70	2500	3	300	292	171	200	114	9	33-1
0442 71	4000	4	230	340	205	180	130	11	31

Note : 40-250 VA transformers have juxtaposed windings with an insulated barrier to provide insulation and interference filtering. Higher ratings have an electrostatic screen between windings

(1) Up to 250 VA may be fixed to symmetrical DIN rail

■ Electrical characteristics

Single phase 50-60 Hz - Class 1
Insulation voltage between windings : 4 510 V
Maximum ambient operating temperatures : 50 °C without derating

Voltage adjustment

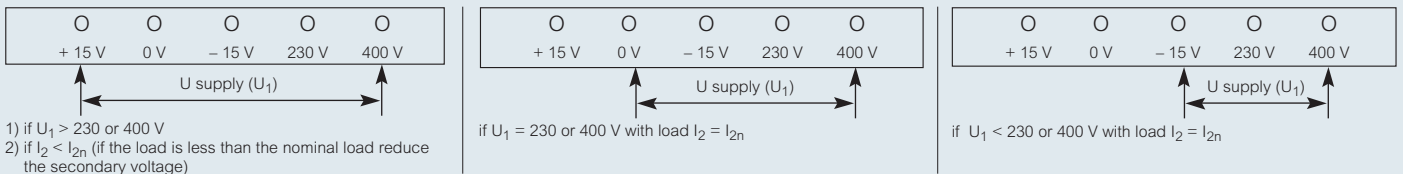

Cat. Nos.	Power (VA)	Admissible instantaneous power (VA) at $\cos \varphi$ of :									No-load loss (W)	On-load loss ⁽¹⁾ (W)	Voltage drop as (%) with $\cos \varphi$:			Efficiency (%) with $\cos \varphi$:			Ucc (%)	Connection capacity			
		0.2	0.3	0.4	0.5	0.6	0.7	0.8	0.9	1			0.3	0.6	1	0.3	0.6	1		Primary cable (mm ²)		Secondary cable (mm ²)	
Primary 230-400 V \pm 15 V - Secondary 24-48 V																							
0442 31	40	63	58	55	52	50	48	48	49	60	3.9	7.3	8.7	10.5	8.5	62	77	84	10.0	1 to 4	1 to 4	1 to 4	1 to 4
0442 32	63	110	102	94	87	83	79	77	78	91	6.0	14.2	7.5	9.4	8.5	57	73	82	9.0	1 to 4	1 to 4	1 to 4	1 to 4
0442 33	100	200	180	160	150	140	130	130	130	150	8.2	15.1	7.3	9.3	8.9	66	80	87	8.9	1 to 4	1 to 4	1 to 4	1 to 4
0442 34	160	340	300	270	250	230	220	210	210	230	11.2	24.6	5.8	7.6	7.7	66	80	87	7.2	1 to 4	1 to 4	1 to 4	1 to 4
0442 35	250	550	490	450	420	400	380	370	370	430	14.9	31.4	5.2	6.6	6.2	70	83	89	6.1	1 to 4	1 to 4	1 to 4	1 to 4
0442 36	400	1800	1300	1100	900	800	700	600	600	500	18.3	46.3	2.1	3.7	5.6	72	84	90	4.2	1 to 4	1 to 4	1 to 4	1 to 4
0442 37	630	2700	2200	1900	1700	1500	1300	1200	1200	1200	24.1	49.4	2.0	3.0	3.9	79	88	93	3.3	1 to 16	1 to 16	1 to 16	1 to 16
0442 38	1000	3400	2800	2300	2000	1800	1600	1500	1400	1300	44.2	74.4	1.3	1.9	2.9	80	89	93	2.4	1 to 16	1 to 16	1 to 16	1 to 16
0442 39	1600	12800	10900	9500	8500	7700	7100	6700	6400	6600	65.5	94.7	1.1	1.6	1.9	84	91	94	1.7	2.5 to 10	1.5 to 16	4 to 16	1.5 to 25
0442 40	2500	4300	3900	3600	3300	3100	3000	2900	2900	3400	86.5	143.4	1.8	2.2	2.0	84	91	95	1.9	4 to 16	1.5 to 25	4 to 35	2.5 to 50
Primary 230-400 V \pm 15 V - Secondary 115-230 V																							
0442 61	40	62	57	53	50	48	47	46	47	57	3.9	7.4	8.7	10.5	8.8	62	76	84	10.1	1 to 4	1 to 4	1 to 4	1 to 4
0442 62	63	110	100	93	86	82	78	76	76	90	6.0	11.8	7.6	9.6	8.9	62	76	84	9.2	1 to 4	1 to 4	1 to 4	1 to 4
0442 63	100	200	180	160	150	140	140	130	130	150	8.2	17.3	7.2	9.2	8.6	63	78	85	8.7	1 to 4	1 to 4	1 to 4	1 to 4
0442 64	160	330	300	270	250	240	230	220	220	250	11.2	23.4	5.8	7.4	7.1	67	80	87	6.9	1 to 4	1 to 4	1 to 4	1 to 4
0442 65	250	560	510	460	430	410	390	380	370	430	14.9	31.7	5.2	6.6	6.2	70	83	89	6.1	1 to 4	1 to 4	1 to 4	1 to 4
0442 66	400	2200	1700	1400	1200	1000	910	830	760	730	18.3	43.9	2.1	3.6	5.2	73	85	90	4.1	1 to 4	1 to 4	1 to 4	1 to 4
0442 67	630	2700	2200	1800	1600	1400	1200	1100	1000	1000	24.1	53.2	2.1	3.3	4.5	78	88	92	3.6	1 to 16	1 to 16	1 to 16	1 to 16
0442 68	1000	3400	2800	2300	2000	1800	1600	1500	1400	1300	44.2	73.6	1.3	2.0	2.7	80	89	93	2.2	1 to 16	1 to 16	1 to 16	1 to 16
0442 69	1600	8700	7500	6600	6100	5400	5000	4700	4500	4700	65.5	95.3	1.1	1.5	1.8	83	91	94	1.5	2.5 to 10	1.5 to 16	2.5 to 10	1.5 to 16
0442 70	2500	9200	8300	7600	7100	6700	6300	6200	6100	7100	86.5	150.1	1.8	2.3	2.2	83	91	94	2.0	4 to 16	1.5 to 25	4 to 16	1.5 to 25
0442 71	4000	16500	14300	12700	11400	10500	9800	9200	8900	9500	87.4	234.8	2.1	2.9	3.3	84	91	94	2.7	4 to 16	1.5 to 25	4 to 16	1.5 to 25

(1) Total losses at nominal load

compact transformers

open type single phase

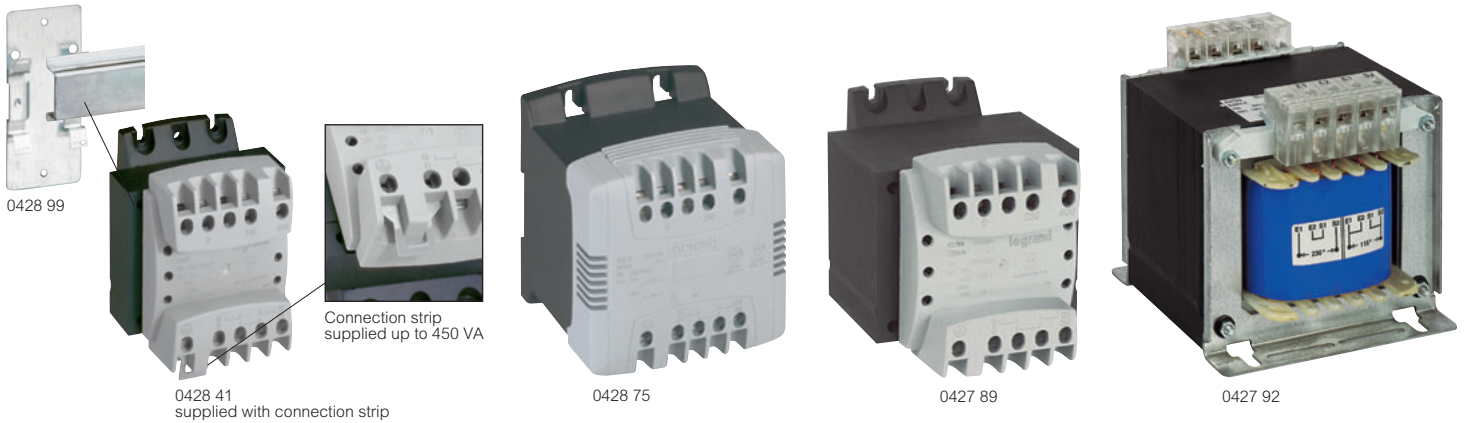

Technical information and dimensions (p. 109)
Transformer protection (p. 111)

Isolating and safety isolating <50 V transformers
 Designed to meet the needs of users with specific VA ratings such as original equipment manufacturers
 The terminals are designed to provide easy and quick connections
 Transformers up to 160 VA can be clipped to rail using accessory or directly fixed using screws through the easily accessible fixing points
 Multiple fixing possibilities :
 - clip to DIN rail using Cat. No. 0044 16 or 0428 99 (\leq 160 VA)
 - screw directly on to Lina 12.5 or Lina 25 mounting plate (\geq 220 VA)
 Recommended protection :
 • for 40 and 63 VA : Type T fuses (5x20) time delay fuse to IEC 60127
 • for >100 VA use MCB Type C

Pack	Cat. Nos.	Single phase	
Safety isolating transformers			
Primary : 230-400 V			
Secondary : 12-24 V			
		Power in VA according to IEC/EN	Admissible instantaneous power at $\cos \varphi$ 0.5
1	0428 40	40 VA	55
1	0428 41	63 VA	91
1	0428 42	100 VA	140
1	0428 43	160 VA	205
1	0428 44	220 VA	290
1	0428 45	310 VA	345
1	0428 47	630 VA	1 520
Primary : 230-400 V			
Secondary : 24 V			
		Power in VA according to IEC/EN	Admissible instantaneous power at $\cos \varphi$ 0.5
1	0428 55	40 VA	55
1	0428 56	63 VA	91
1	0428 57	100 VA	140
1	0428 58	160 VA	205
1	0428 59	220 VA	290
1	0428 60	310 VA	345
1	0428 61	450 VA	1 100
1	0428 62	630 VA	1 520
Safety isolating transformers			
Primary : 230-400 V			
Secondary : 24-48 V			
		Power in VA according to IEC/EN	Admissible instantaneous power at $\cos \varphi$ 0.5
1	0428 70	40 VA	55
1	0428 71	63 VA	91
1	0428 72	100 VA	140
1	0428 73	160 VA	205
1	0428 74	220 VA	290
1	0428 75	310 VA	345
1	0428 77	630 VA	1 520

Pack	Cat. Nos.	Single phase	
Isolating transformers			
Primary : 230-400 V			
Secondary : 115 V			
With centre tap			
		Power in VA according to IEC/EN	Admissible instantaneous power at $\cos \varphi$ 0.5
1	6423 62	63 VA	91
1	6423 63	100 VA	140
1	6423 64	160 VA	205
1	6423 65	220 VA	290
1	6423 66	310 VA	345
1	6423 68	630 VA	1 520
Isolating transformers			
Primary : 230-400 V			
Secondary : 115-230 V			
		Power in VA according to IEC/EN	Admissible instantaneous power at $\cos \varphi$ 0.5
1	0427 85	40 VA	55
1	0427 86	63 VA	91
1	0427 87	100 VA	140
1	0427 88	160 VA	205
1	0427 89	220 VA	290
1	0427 90	310 VA	345
1	0427 92	630 VA	1 520

Pack	Cat. Nos.	Accessories
10	0044 16	Clips for fixing up to 160 VA on to rail EN 60715
		Claw width 10 mm Threaded hole for M4 screws (Use two clips per transformer)
5	0428 99	Mounting bracket DIN rail mounting bracket

Note : Other VA ratings available on request. Please consult us

For modular transformers

see p. 116

For protection devices

see p. 79

compact transformers

open type single phase

Technical information

Conform to IEC/EN 61558-2-4 for 48 V, 115 V and 230 V and IEC/EN 61558-2-6 for 12 V and 24 V secondary
 Products suitable for building into equipment conforming to EN 61131-2, EN 60204-1 and EN 60439-1 standards
 IP 2x or xxB up to 250 VA - IK 04
 Single phase 50-60 Hz - class I

Insulation voltage : Primary/Secondary 4 470 V
 Primary/Earth 2 240 V
 Secondary/Earth (12 - 24 V) = 250 V ; 48, 115 and 230 V = 1 780 V
 Max. ambient operating temperature : 35 °C without derating
 Protected against accidental contact with live parts up to 220 VA

Dimensions

Fig. 1 - 40 to 220 VA

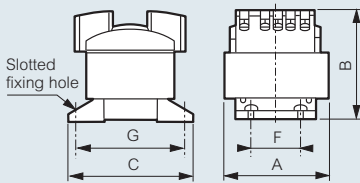

Fig. 2 - 310 VA⁽¹⁾

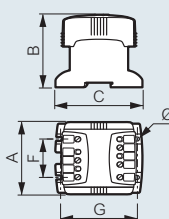
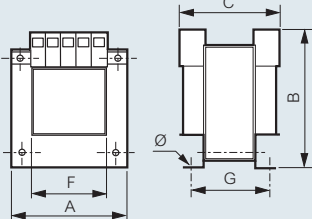

Fig. 3 - 450 to 630 VA



(1) Subject to secondary voltage (see tables)

Primary : 230 - 400 V
 Secondary : 12 - 0 - 12 V
 0 - 12 - 24 V

Cat. Nos.
 0428 40 to 0428 47

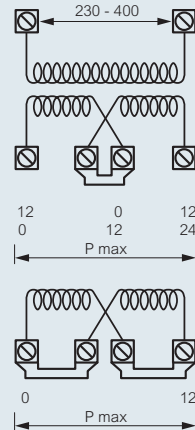

Primary : 230 - 400 V
 Secondary : 24 - 0 - 24 V
 0 - 24 - 48 V

Cat. Nos.
 0428 70 to 0428 77

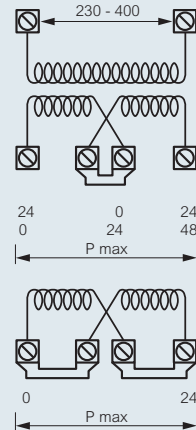

Primary : 230 - 400 V
 Secondary : 115 - 0 - 115 V
 0 - 115 - 230 V

Cat. Nos.
 0427 85 to 0427 92

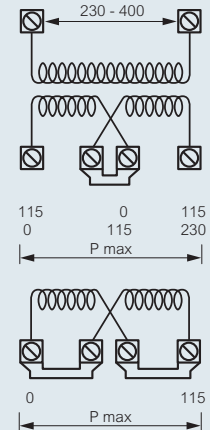

Electrical characteristics

Cat. Nos.	Power (VA)	Dimensions (mm)			Fixing (mm)			Weight (kg)	No-load loss (W)	Total losses @ 100% load (W)	Voltage drop as % with		Efficiency with		Ucc %	Primary connection cable mm ²			Secondary connection cable mm ²			Fig.
		A	B	C	F	G	Ø				cos φ 1	cos φ 0.45	cos φ 1	cos φ 0.45		flexible	rigid	Ø mm	flexible	rigid	Ø mm	
Primary 230-400 V - 24 V or 2 x 12 V secondary																						
0428 40	40	84	70	98	40	86	4.5	0.9	3.7	13.1	18.3	12.7	0.75	0.6	15.6	1 to 4	1 to 4	4-5	1 to 4	1 to 4	4-5	1
0428 41	63	84	77	98	40	86	4.5	1.3	4.9	16.3	13.5	10.2	0.8	0.6	11.8	1 to 4	1 to 4	4-5	1 to 4	1 to 4	4-5	1
0428 42	100	84	86	98	40	86	4.5	1.6	6.2	21.0	10.5	8.7	0.8	0.7	9.5	1 to 4	1 to 4	4-5	1 to 4	1 to 4	4-5	1
0428 43	160	84	104	98	40	86	4.5	2.4	9.1	31.8	8.8	7.4	0.8	0.7	7.9	1 to 4	1 to 4	4-5	1 to 4	1 to 4	4-5	1
0428 44	220	96	115	110	40	98	4.5	3.4	12.6	40.0	6.9	6.3	0.85	0.7	6.5	1 to 4	1 to 4	4-5	1 to 4	1 to 4	4-5	1
0428 45	310	106	123	115	50	100	5.2	3.8	14.2	54.9	7.3	6.2	0.85	0.7	8.2	1 to 4	1 to 4	4-5	1 to 4	1 to 4	4-5	2
0428 47	630	126	126	141	90	105	6.5	8.0	25.5	62.4	4.3	2.6	0.91	0.82	3.5	1 to 4	1 to 4	4-5	1 to 16	1 to 25	6-5	3
Primary 230-400 V - 24 V secondary																						
0428 55	40	84	70	98	40	86	4.5	0.9	3.7	13.1	18.3	12.7	0.75	0.58	15.6	1 to 4	1 to 4	4-5	1 to 4	1 to 4	4-5	1
0428 56	63	84	77	98	40	86	4.5	1.3	4.9	16.3	13.5	10.2	0.79	0.64	11.8	1 to 4	1 to 4	4-5	1 to 4	1 to 4	4-5	1
0428 57	100	84	86	98	40	86	4.5	1.6	6.2	21.0	10.5	8.7	0.83	0.68	9.5	1 to 4	1 to 4	4-5	1 to 4	1 to 4	4-5	1
0428 58	160	84	104	98	40	86	4.5	2.4	9.1	31.8	8.8	7.4	0.83	0.69	7.9	1 to 4	1 to 4	4-5	1 to 4	1 to 4	4-5	1
0428 59	220	96	115	110	40	98	4.5	3.4	12.6	40.0	6.9	6.3	0.85	0.71	6.5	1 to 4	1 to 4	4-5	1 to 4	1 to 4	4-5	1
0428 60	310	106	123	115	50	100	5.2	3.8	14.2	54.9	7.3	6.2	0.85	0.72	8.2	1 to 4	1 to 4	4-5	1 to 4	1 to 4	4-5	2
0428 61	630	126	126	126	90	94	6.5	6.0	21.8	63.9	6.0	3.2	0.88	0.76	4.9	1 to 4	1 to 4	4-5	1 to 16	1 to 25	6-5	3
0428 62	630	126	126	141	90	105	6.5	8.0	25.5	62.4	4.3	2.6	0.91	0.82	3.5	1 to 4	1 to 4	4-5	1 to 16	1 to 25	6-5	3
Primary 230-400 V - 48 V or 2 x 24 V secondary																						
0428 70	40	84	77	98	40	86	4.5	1.3	3.7	12.9	18.0	12.5	0.8	0.6	15.4	1 to 4	1 to 4	4-5	1 to 4	1 to 4	4-5	1
0428 71	63	84	86	98	40	86	4.5	1.6	4.9	16.5	13.7	10.3	0.8	0.6	11.9	1 to 4	1 to 4	4-5	1 to 4	1 to 4	4-5	1
0428 72	100	84	104	98	40	86	4.5	2.4	6.2	21.0	10.4	8.7	0.8	0.7	9.4	1 to 4	1 to 4	4-5	1 to 4	1 to 4	4-5	1
0428 73	160	84	104	98	40	86	4.5	2.4	9.1	31.6	8.7	7.3	0.8	0.7	7.8	1 to 4	1 to 4	4-5	1 to 4	1 to 4	4-5	1
0428 74	220	96	115	110	40	98	4.5	3.4	12.6	39.5	6.7	6.2	0.85	0.7	6.3	1 to 4	1 to 4	4-5	1 to 4	1 to 4	4-5	1
0428 75	310	106	123	115	50	100	5.2	3.8	14.2	54.9	7.3	6.2	0.85	0.7	8.2	1 to 4	1 to 4	4-5	1 to 4	1 to 4	4-5	2
0428 77	630	126	126	141	90	105	6.5	8.0	25.5	63.3	4.2	2.6	0.9	0.8	3.5	1 to 4	1 to 4	4-5	1 to 16	1 to 25	6-5	3
Primary 230-400 V - 115-230 V secondary																						
0427 85	40	84	70	98	40	86	4.5	1.0	3.7	10.9	18.5	12.7	0.75	0.58	15.7	1 to 4	1 to 4	4-5	1 to 4	1 to 4	4-5	1
0427 86	63	84	77	98	40	86	4.5	1.3	4.9	15.6	12.5	9.7	0.80	0.65	11.0	1 to 4	1 to 4	4-5	1 to 4	1 to 4	4-5	1
0427 87	100	84	86	98	40	86	4.5	1.6	6.2	21.1	10.7	8.9	0.83	0.68	9.7	1 to 4	1 to 4	4-5	1 to 4	1 to 4	4-5	1
0427 88	160	84	104	98	40	88	4.5	2.4	9.1	32.3	8.8	7.3	0.83	0.69	7.9	1 to 4	1 to 4	4-5	1 to 4	1 to 4	4-5	1
0427 89	220	96	115	110	40	98	4.5	3.4	12.6	40.1	6.8	6.2	0.85	0.71	6.4	1 to 4	1 to 4	4-5	1 to 4	1 to 4	4-5	1
0427 90	310	106	123	115	50	100	5.2	3.8	14.2	54.0	7.3	6.2	0.85	0.7	8.2	1 to 4	1 to 4	4-5	1 to 4	1 to 4	4-5	2
0427 92	630	126	126	123	90	105	6.5	7.8	25.5	64.6	4.3	2.6	0.91	0.81	3.5	1 to 4	1 to 4	4-5	1 to 4	1 to 4	4-5	3

how to calculate the rated power of a transformer

In equipment containing control devices, the transformer power depends on the maximum power required at a given moment (inrush power), the permanent power, the voltage drop and power factor

When determining the permissible instantaneous power (inrush power) required, the following factors should always be taken into account :

- two inrush currents cannot occur at the same time
- power factor $\cos \varphi$ equals 0.5
- at maximum, 80% of devices are supplied at the same time (this percentage can be calculated precisely for each device)

■ Determination of the inrush power

Where a simplified calculation of the power is required, the following formula can be used :

$$P_{\text{inrush}} = 0.8 (\Sigma P_m + \Sigma P_v + P_a)$$

ΣP_m : sum of all contactor steady state power levels (holding power)

ΣP_v : sum of all power levels of indicators and LEDs⁽¹⁾

P_a : inrush power of the largest contactor

Example :

A machine tool control cabinet comprising :

- 10 contactors for 4 kW motors, with a steady state power of 8 VA
- 2 contactors for 18.5 kW motor, with a steady state power of 20 VA
- 1 contactor for 45 kW motor, with a steady state power of 20 VA, and an inrush power of 250 VA $\cos \varphi$ 0.5
- 20 remote control relays, with a steady state power of 4 VA
- 30 signalling LEDs, with a consumption of 1 VA each

$$- \Sigma P_m = 220 \text{ VA } \{ (10 \times 8 \text{ VA}) + (2 \times 20 \text{ VA}) + (1 \times 20 \text{ VA}) + (20 \times 4 \text{ VA}) \}$$

$$- \Sigma P_v = 30 \text{ VA } (30 \times 1 \text{ VA})$$

$$- P_a = 250 \text{ VA}$$

$$P_{\text{inrush}} = 0.8 (220 + 30 + 250) = 400 \text{ VA at } \cos \varphi \text{ 0.5}$$

■ Determination of the rated power of a transformer

For control transformers, in particular, simply start with an inrush power at $\cos \varphi$ 0.5 and read the size from the table below

Rated power in VA IEC and CSA	Admissible instantaneous power in VA IEC/EN 61558-2-2 with $\cos \varphi$ of :								
	0.2	0.3	0.4	0.5	0.6	0.7	0.8	0.9	1
40	90	80	72	66	61	57	53	51	53
63	160	140	130	120	110	100	90	90	90
100	240	190	170	160	150	140	130	130	140
160	480	400	350	300	270	240	220	200	190
250	830	690	590	510	450	400	360	330	310
400	1 600	1 400	1 200	1 000	900	800	800	700	700
630	2 000	1 800	1 500	1 400	1 200	1 100	1 100	1 000	1 000
1 000	5 400	4 600	4 000	3 600	3 200	3 000	2 700	2 600	2 500
1 600	9 000	8 000	7 200	6 600	6 100	5 700	5 400	5 300	5 600
2 500	7 300	6 600	6 000	5 700	5 200	4 900	4 700	4 600	5 100
4 000	34 500	28 800	24 400	17 000	16 600	16 400	14 800	13 400	12 400

From the example above, an inrush of 460 VA at $\cos \varphi$ 0.5 gives a transformer size of 250 VA

■ Checking the selection

As a precaution, make the following checks on each of your devices :

- first calculate the sum of the steady state power for the coils and the LEDs powered at the same time
- then apply a coefficient : use either our hypothetical figure of 80% of devices at steady state power, or the actual calculation for your equipment
- the power of the chosen transformer shall be greater than or equal to the result of the calculation

(1) LED = Light Emitting Diode

■ General information

Transformers take around 25 times the load at switch on

$VA \div V =$ current in the winding
either PRIMARY or SECONDARY

$$\text{i.e. } \frac{300 \text{ VA}}{12 \text{ V}} = 25 \text{ A} \times 25 = 625 \text{ A}$$

The power triangle :

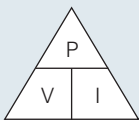

■ Secondary power/voltage information

Example : compact transformer 100 VA - 12/24 V Cat. No. 0428 42

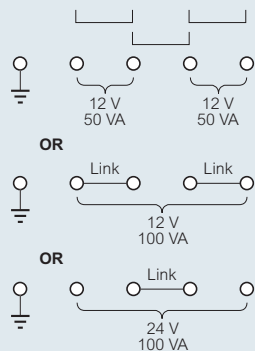

■ Identification of markings

• Changing voltage



Isolation transformer (functional insulation between primary and secondary)



Auto transformer (no insulation between primary and secondary)

• Control circuit power supply



Control transformer (functional insulation between primary and secondary)

• Electric shock protection

- Protection against direct and indirect contact by :



Safety transformers (reinforced insulation between primary and secondary, no-load voltage < 50 V)

- Protection against indirect contact by :



Circuit separation transformers (reinforced insulation between primary and secondary)

The transformer function(s) can either be defined by the equipment designer or can be imposed by installation guidelines or the equipment standard

Definitions of electrical shock :

- Electric shocks : physiopathological effect resulting from an electrical current passing through the human body
- Direct contact : persons coming into contact with live parts (connected to the mains)
- Indirect contact : persons coming into contact with grounding which is accidentally live following an insulation fault

protection of transformers, primary and secondary circuits

■ Protection of transformers

In accordance with the IEC/EN 61558 standard, transformers must be protected against overload and short-circuit conditions which may occur during normal operation.

The standard does not specify the type or location of the protective device : it is the manufacturer's responsibility to choose the most suitable position, either on the primary or secondary side. The rating, type and location of the protective device are to be indicated on the device identification plate.

■ Protection of the primary and secondary circuits

General

Circuits must be protected against overload and short-circuit conditions. Protection against overload is compulsory if the circuit is likely to be affected by an overload current. This protection can be installed at the supply source or end of the circuit.

Protection against a short-circuit is compulsory in all installations ; this protection has to be installed at the supply source of the circuit.

Supply circuits (transformer primary)

The transformer is a device which cannot itself generate overload. Its supply circuit therefore only requires protection against a short-circuit. When a transformer is energised, a very high inrush current (around 25 In)⁽¹⁾ is produced for approximately 10 ms.

When protecting the circuit, both factors must be considered.

Legrand offers three possibilities :

- type aM cartridge fuses,
- type D MCBs (with magnetic tripping set at 12 In average)
- type C MCBs (with magnetic tripping set at 7 In average)

Example : control transformer 630 VA - 230/24 V Cat. No. 0442 37

In primary 2·74 A (VA ÷ V)

I inrush at power-up 68·5 A (25 x 2·74 A)

Protection against a short-circuit can be provided by :

- type aM 6 A cartridge fuse
- type D 6 A MCBs
- type C 13 A MCBs - (16 A nearest UK)

■ Primary protection

Minimum protection rating for primary supply of the transformer :

Power (VA)	230 V single-phase			400 V single-phase			400 V three-phase		
	aM fuse	C MCB	D MCB	aM fuse	C MCB	D MCB	aM fuse	C MCB	D MCB
40	0·5	1		0·25	1				
50	1	1	1	0·5	1				
63	1	2	1	0·5	1				
100	1	3	1	1	2	1			
150	2	6	2	1	3	1			
160	2	6	2	1	3	1	1		
200	2	6	3	1	3	2			
250	2	6	3	1	6	2	1		
300	4	10	6	2	6	2			
400	4	10	6	2	6	2	2		
500	6	16	6	4	10	3			
630	6	16	6	4	10	3	2	6	2
750	8	16	10	6	10	6	2	6	3
1 000	10	20	10	6	16	6	4	10	3
1 250	10	25	16	6	20	10	4	10	6
1 500	10	32	16	10	20	10	4	16	6
1 600	10	32	16	10	20	10	6	16	6
2 000	12	40	16	10	25	10			
2 500	16	50	20	10	32	16	6	20	10
3 000	16	50	32	12	40	20			
3 500	20	50	32	16	40	20			
4 000	20	80	32	16	50	20	10	32	16
5 000	25	100	40	16	63	25	12	32	16

These values are given for information only for transformers with inrush currents of around 25 In.

(1) In = nominal rating of circuit

■ Protection of the secondary circuit

The secondary circuit must be protected against overload and short-circuit conditions. For overload, check that the protection rating chosen is lower than or equal to the transformer secondary current. For short-circuit, ensure that a short-circuit occurring at the furthest point of the circuit will trigger the protective device within 5 seconds.

Legrand offers two possibilities :

- type gG cartridge fuses
- type C MCBs (with magnetic tripping set at 7 In average)

If the transformer only supplies a single circuit, and provided the calculations show perfect compatibility, transformer protection (if on secondary) and circuit protection can be one and the same. A single protective device performs both functions (see table of transformer protective devices).

If the transformer supplies several circuits, overload and short-circuit calculations must be performed for each individual circuit. To check that the device chosen is suitable, an approximate minimum short-circuit value can be obtained using the following formula.

■ Formula for determining the secondary protection rating

Calculate the minimum short-circuit at the furthest point on the circuit :

$$I_{c/c \text{ min.}} = \frac{U_s}{\left(\frac{U^2 s}{P} \times \frac{U_{c/c \%}}{100} \right) + \frac{2\rho l}{S}}$$

Us = transformer secondary voltage

P = transformer power

U c/c % = transformer short-circuit voltage

l = line length in m

S = line cross section in mm²

ρ copper = 0·027 Ω mm²/m

Choose the protection rating so as to obtain a cut-off time of 5 seconds max. for a current I c/c defined above :

$$\text{type gG fuse : } I_n \leq \frac{I_{c/c \text{ min.}}}{4}$$

$$\text{type C MCB : } I_n \leq \frac{I_{c/c \text{ min.}}}{8}$$

Example : control transformer 630 VA - 230/24 V Cat. No. 0442 37

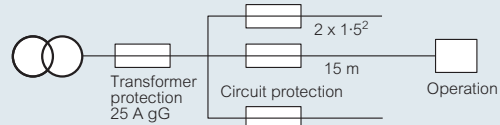

$$I_{c/c \text{ min.}} = \frac{24}{\left(\frac{24^2}{630} \times \frac{3·3}{100} \right) + \frac{2 \times 0·027 \times 15}{1·5}} = 44·42 \text{ A} = \text{Use either :}$$

$$\frac{44·42}{4} = 11·10 \rightarrow \text{gG fuse 10 A max.} \quad \frac{44·42}{8} = 5·55 \rightarrow \text{C type MCB 5 A max.}$$

■ Secondary protection

Ratings and types of protective devices to be used for single phase transformer protection according to VA rating and secondary voltage

Rated power (VA) IEC/CSA	24 V				48 V				110 V				230 V			
	Fuse		Curve C MCB		Fuse		Curve C MCB		Fuse		Curve C MCB		Fuse		Curve C MCB	
	A	Type			A	Type			A	Type			A	Type		
40	2	T			1	T			400 m	T			200 m	T		
50	2	T	2		1	T	1		500 m	T	0·5		200 m	T	0·2	
63	3·15	T			1·6	T			630 m	T			315 m	T		
100	4	gG	4	2	gG	2	1	gG	1	0·5	gG	0·5				
150	6	gG	6	4	gG	4	2	gG	2	1	gG	1				
160	8	gG	8	4	gG	4	2	gG	2	1	gG	1				
200	8	gG	8	4	gG	4	2	gG	2	1	gG	1				
250	10	gG	10	6	gG	6	2	gG	2	1	gG	1				
300	12	gG	12	6	gG	6	4	gG	4	2	gG	2				
400	16	gG	16	8	gG	8	4	gG	4	2	gG	2				
500	20	gG	20	10	gG	10	6	gG	6	2	gG	2				
630	25	gG	25	12	gG	12	6	gG	6	3	gG	3				
750		gG		16	gG	16	8	gG	8	4	gG	4				
1 000	40	gG	40	20	gG	20	8	gG	8	4	gG	4				
1 250		gG			gG		12	gG	12		gG					
1 500		gG			gG		16	gG	13	8	gG	8				
1 600	63	gG	63	32	gG	32	16	gG	13	8	gG	8				
2 000		gG			gG		20	gG	20	8	gG	8				
2 500	100	gG	100	50	gG	50	20	gG	20	10	gG	10				
3 000		gG			gG		32	gG	32		gG					
3 500		gG			gG		32	gG	32		gG					
4 000		gG			gG		32	gG	32	16	gG	16				
5 000		gG			gG		50	gG	50		gG					

filtered power supplies

open type single phase

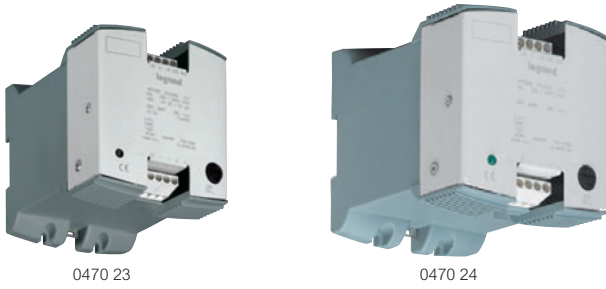

Dimensions and technical information (opposite and p. 113)

Filtered power supplies for PLCs and other equipment requiring a voltage of 12 V DC or 24 V DC

Include :

- twin output terminals for ease of connection
- safety transformer with interference filtration
- fuse protection on output
- green LED output voltage indicator
- capacitor in filtered range

Supplied with a connection link for quick connection between - and \pm up to 15 A

Fixing options :

- clip directly to DIN rail up to 24 W
- clip on or screw fixing up to 120 W
- screw fixing only above 120 W

Pack	Cat. Nos.	Single phase filtered		Terminal capacity (mm ²) Flexible cable	
		12 V\equiv output			
		230-400 V \pm 15 V \sim (input) / 12 V \equiv (output)			
		Power (W)	Current rating (A)	Input	Output
1	0470 01	12	1	6	6
1	0470 02	30	2.5	6	6
1	0470 03	60	5	6	6
1	0470 04	120	10	6	6
		24 V\equiv output			
		230-400 V \pm 15 V \sim (input) / 24 V \equiv (output)			
		Power (W)	Current rating (A)	Input	Output
1	0470 20	12	0.5	6	6
1	0470 21	24	1	6	6
1	0470 22	60	2.5	6	6
1	0470 23	120	5	6	6
1	0470 24	240	10	6	6
1	0470 25	360	15	6	6

filtered power supplies

open type single phase

■ Dimensions

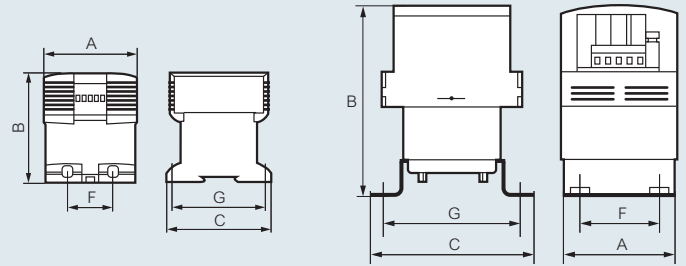

Cat. Nos. 0470 01/02/03 and 0470 20/21/22/23

Cat. Nos. 0470 04/24/25

Cat. Nos.	A (mm) Width	B (mm) Depth	C (mm) Height	F x G (mm) Fixing ctrs	\varnothing (mm)	Weight (Kg)
0470 01	68	98	88	DIN \perp	-	1.00
0470 02	93	121	105	DIN \perp	4-6	2.45
0470 03	105	135	115	DIN \perp	4-6	3.60
0470 04	126	186	175	75 x 150	5-5	6.35
0470 20	68	98	88	DIN \perp	-	1.00
0470 21	68	98	88	DIN \perp	-	1.00
0470 22	93	121	105	DIN \perp	4-6	2.45
0470 23	105	135	115	DIN \perp	4-6	3.60
0470 24	126	186	175	75 x 150	5-5	6.40
0470 25	126	206	175	75 x 150	5-5	7.60

■ Technical information

Conform to IEC/EN 61558-2-6, UL 60950
CAN/CSA C22.2 N° 60 950.00



Products are compatible with EN 61131-2, EN 60204 and EN 60439-1 apparatus

Input voltage : 230/400 V \sim \pm 15 V single phase 50/60 Hz - Class I
Output voltage : 12 V \equiv or 24 V \equiv
Insulation voltage : Input/Output 4 510 V
Input/Earth 2 260 V
Output/Earth 500 V

Max. ambient temperature without derating : 60 °C

Ripple factor : <3 %

Cooling by natural convection

Integral fuse protection on output

Can be fixed to symmetrical rail \perp 7.5 mm or 15 mm depth EN 60715

Screw fix only Cat. Nos. 0470 04/24 and 25

Screw fix or clip on to DIN rail Cat. Nos. 0470 02/03/22 and 23

Supplied with a connection link for quick connection between terminals and earth

Note : To conform to UL, product must be mounted in the vertical position (mounting against support) for Class A ambient temperature rating 25 °C

■ Operating diagram

Operating current up to 15 A

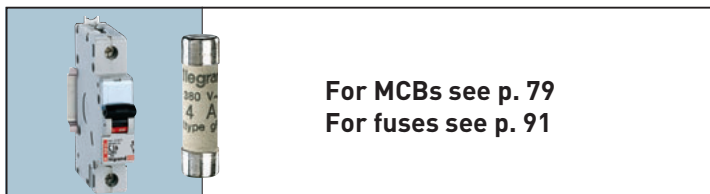
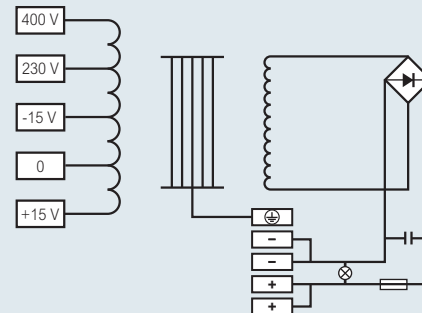

filtered power supplies

open type single phase (continued)

■ Circuit protection (double pole MCB)

Single phase		Input 230/400 V ±15 V			
U I	Protection	12 V		24 V	
		Internal	External	Internal	External
0.5 A	Power supply			0470 20	
	MCB/Fuse			T 0.5 A L ⁽¹⁾	0069 12 (1 A)
1 A	Power supply	0470 01		0470 21	
	MCB/Fuse	T 1 A L ⁽¹⁾	0069 12 (1 A)	T 1 A L ⁽¹⁾	0069 12 (1 A)
2.5 A	Power supply	0470 02		0470 22	
	MCB/Fuse	T 2.5 A L ⁽¹⁾	0069 14 (3 A)	T 2.5 A L ⁽¹⁾	0069 14 (3 A)
5 A	Power supply	0470 03		0470 23	
	MCB/Fuse	T 5 A L ⁽¹⁾	0069 16 (6 A)	T 5 A L ⁽¹⁾	0069 16 (16 A)
10 A	Power supply	0470 04		0470 24	
	MCB/Fuse	T 10 A L ⁽¹⁾	0069 18 (10 A)	T 10 A L ⁽¹⁾	0069 18 (10 A)
15 A	Power supply			0470 25	
	MCB/Fuse				0069 20 (16 A)

- (1) T type fuse is a time delay fuse (5 x 20 mm)
(2) Filtered modular power supply
(3) Type gG fuse 10 x 38 mm

■ Primary fuse protection required for UL conformity

Supply 230 V : Use 250 V time delay HRC fuse
UL Category Code JDYX2
Supply 400 V : Use 500 V time delay HRC fuse
UL Category Code JDYX

Secondary voltage	12 V		24 V	
Primary voltage	230 V ~	400 V ~	230 V ~	400 V ~
Power supply			0470 20	
Fuse rating			0.315 A T	2/10 A
Power supply	0470 01		0470 21	
Fuse rating	0.315 A	2/10 A	0.4 A	2/10 A
Power supply	0470 02		0470 22	
Fuse rating	0.8 A	4/10 A	1 A	6/10 A
Power supply	0470 03		0470 23	
Fuse rating	1.6 A	8/10 A	2 A	1 A
Power supply	0470 04		0470 24	
Fuse rating	3.15 A	1 ¹ / ₂ A	4 A	2 ¹ / ₄ A
Power supply			0470 25	
Fuse rating			6.3 A	3 A

■ Electrical characteristics

Cat. Nos.	Voltage (V)	Current rating (A)	Weight (Kg)	Input under load 230 V (A)	Input under load 400 V (A)	Operating voltage				No-load loss (W)	Total loss at nominal load 100 % (W)	Voltage drop (%)
						No-load (V)	Underload (V)	With 100 mA load and input voltage +10%	With nominal load input voltage -15%			
Output 12 V												
0470 01	12	1	1	0.12	0.06	14.4	11.7	15.5	10.3	4.4	7.3	23.5
0470 02	12	2.5	2.45	0.33	0.19	13.9	11.6	15.2	10.2	8.3	11.9	19.4
0470 03	12	5	3.6	0.60	0.34	14.1	12.1	15.5	10.5	11.4	17.1	17.2
0470 04	12	10	6.35	1.24	0.72	14.7	11.8	16.1	10.4	20.2	33.7	24.7
Output 24 V												
0470 20	24	0.5	1	0.12	0.06	27.6	22.9	29.4	20.1	4.4	7.3	20.66
0470 21	24	1	1	0.18	0.10	29.0	22.8	31.2	20.2	4.4	10.3	27.03
0470 22	24	2.5	2.45	0.47	0.27	27.8	23.3	30.4	20.4	8.3	16.3	19.46
0470 23	24	5	3.6	0.88	0.51	27.5	23.2	30.2	20.3	11.4	25.4	18.68
0470 24	24	10	6.35	1.88	1.09	27.7	23.5	30.5	20.5	20	45.3	18.20
0470 25	24	15	7.6	2.53	1.46	27.5	23.2	30.2	20.2	23	54.7	18.70

power contactors



0041 16



0041 47



A location on the device enables a supply busbar to run through (except 40 and 63 A)



0041 31



0040 78



0041 85



Technical information (p. 115)
Dimensions (p. 117)

Conform to EN 61095

Power contactors have a handle covered with a blanking plate

Stop or start override without automatic return is possible (use tool)

Pack	Cat. Nos.	Power contactors with 24 V~ coil			
1	0041 14	Double pole (L + N) - 250 V~			
		24 V~ coil	Type of contact	Number of 17.5 mm modules	
		I max. 16 A		N/C + N/O	1
		I max. 25 A		2 N/O	1

Pack	Cat. Nos.	Power contactors with 230 V~ coil			
4	0041 26	Double pole (L + N) - 250 V~			
		230 V~ coil	Type of contact	Number of 17.5 mm modules	
		I max. 16 A		N/C + N/O	1
		I max. 25 A		2 N/O	1
1	0041 29	I max. 25 A		2 N/C	1
1	0040 68	I max. 40 A		2 N/O	2
1	0040 75	I max. 63 A		2 N/O	2
1	0040 69	Triple pole - 400 V~			
		230 V~ coil	Type of contact	Number of 17.5 mm modules	
		I max. 40 A		3 N/O	3
		I max. 63 A		3 N/O	3

Pack	Cat. Nos.	Power contactors with 230 V~ coil (continued)			
5	0041 31	Four pole - 400 V~			
		230 V~ coil	Type of contact	Number of 17.5 mm modules	
		I max. 25 A		4 N/O	2
		I max. 25 A		4 N/C	2
1	0041 33	I max. 25 A		2 N/O + 2 N/C	2
1	0040 70	I max. 40 A		4 N/O	3
1	0040 78	I max. 63 A		4 N/O	3

Signalling auxiliaries for contactors

Auxiliary changeover switch
Used to indicate the position status of the contacts on the product to which it is associated

For 1 module contactors 16 A to 25 A

Maximum 2 auxiliary devices per contactor
Fitted on left-hand side of contactor

I max.	Voltage	Changeover switch	Number of modules
5 A	250 V~	N/C + N/O	0.5

For 2 module contactors 25 A

Maximum 2 auxiliary devices per contactor
Fitted on left-hand side of contactor

I max.	Voltage	Changeover switch	Number of modules
5 A	250 V~	N/C + N/O	0.5

For 40 and 63 A contactors

Maximum 1 auxiliary device per contactor
Fitted on left-hand side of contactor

I max.	Voltage	Changeover switch	Number of modules
5 A	250 V~	N/C + N/O	0.5

Accessory

10	0044 40	Spacing unit 0.5 module To be placed between every 2 contactors to aid cooling
----	---------	---



power contactors

■ Technical characteristics

- Rated impulsive resistant current (Uimp) : 4 kV
- Mechanical endurance (No. of operating cycles) : 10⁶
- Temperature :
 - Operating : - 25 °C to + 40 °C
 - Storage : - 40 °C to +70 °C

Protection of contactors against short circuits conforming to IEC EN 61095, conditional short circuit current Iq = 6 kA

Iq = 6 kA for 16 to 25 A contactors

Iq = 3 kA for 40 to 63 A contactors

MCB or gG fuse, rating :

- ≤ 16 A for 16 A rating
- ≤ 25 A for 25 A rating
- ≤ 40 A for 40 A rating
- ≤ 63 A for 63 A rating

■ Choice of contactor rating

For a lifetime of 10 years with 200 days of annual use

■ Heating (AC.7a)

Maximum power in kW according to the number of operations per day

Operations per day	16 A	25 A	40 A	63 A
230 V/single phase network				
≤ 50	3.5	4.5	9	14
75	3	3.5	7.5	12
100	2.5	3	6	9.5
250	1.5	2	4	6
500	1	1	2.5	4.5
400 V/3 phase network				
≤ 50	10	13	26	41
75	9	11	22	35
100	7	9	17	26
250	3	4	8	13
500	2	3	6	9

■ Lighting

Maximum number of lamps, tubes, according to their unit power requirement (W) for 230 V single phase

• Incandescent and halogen lamps

Unit power (W)	40 W	60 W	75 W	100 W	150 W	200 W	300 W	500 W	1000 W
16 A	40	32	27	21	13	11	8	4	2
25 A	47	37	30	23	15	12	8	5	2
40 A	118	87	72	52	36	26	18	11	7
63 A	156	115	96	71	48	35	25	15	8

• Halogen lamps with 12 V ferromagnetic transformer

Unit power (W)	20 W	50 W	75 W	100 W	150 W
16 A	16	11	9	7	4
25 A	19	12	10	8	5
40 A	45	29	25	20	15
63 A	64	42	34	28	19

• Fluorescent tubes with starter

Unit power (W)	15 W	18 W	20 W	36 W	40 W	58 W	65 W	115 W	140 W
Single non compensated	16 A	24	24	24	22	15	15	8	8
	25 A	28	28	28	26	17	17	10	10
	40 A	75	75	75	65	40	40	22	22
	63 A	105	105	105	93	58	58	33	33
Single parallel compensated	16 A	16	16	16	16	11	11	6	6
	25 A	18	18	18	18	13	13	6	6
	40 A	40	40	40	40	30	30	14	14
	63 A	60	60	60	60	43	43	20	20
Double serial compensated	16 A	–	32	32	18	11	11	7	7
	25 A	–	38	38	21	13	13	9	9
	40 A	–	85	85	45	29	29	18	18
	63 A	–	120	120	65	40	40	24	24

Unit power (W)	16 A	25 A	40 A	63 A	100 A
4 x 18 W	16	19	48	67	–

■ Motors (Ac.7b)

Maximum power in Kw

	16 A	25 A	40 A	63 A
Single phase 230 V motor with capacitor	0.9	1.1	2.5	4
3 phase 400 V motor	2.7	3.3	7.5	12

Other load types please contact us

■ Connection (mm²)

Type of wire	Rated current ≤ 25 A	Rated current 40 and 63 A
Stranded	1 x 6 or 2 x 4	1 x 25 or 2 x 10
Flexible	1 x 6 or 2 x 4	1 x 25 or 2 x 10
Flexible with single ferrule	1 x 4	1 x 16
Flexible with double ferrule	2 x 2.5	2 x 16

■ Control consumption

	24 V		230 V	
	1 module	1 module	2 modules	3 modules
Inrush	12 VA	12 VA	35 VA	45 VA
Holding	3 VA	3 VA	3 VA	7 VA

To protect contactors against short circuits (according to IEC 61095, conditional short circuit Iq = 3 kA), it is advisable to use :

Contactors rating (A)	MCB or use Gg or aM rating (A)
16 / 25	≤ 20
40	≤ 40
63	≤ 63

Derating of contactors mounted in a modular enclosure if the interior temperature is > 40 °C

Rated current of contactor	40 °C	50 °C	60 °C	70 °C
Ie = 16 A	16 A	14 A	12 A	10 A
Ie = 25 A	25 A	22 A	20 A	18 A
Ie = 40 A	40 A	36 A	32 A	29 A
Ie = 63 A	63 A	57 A	50 A	45 A

Insert a spacer module every 2 contactors Cat. No. 0044 40

Frequency 50/60 Hz

Rated impulses with stand voltage (Uimp) : 4 kV

Mechanical endurance (No. of operating cycles) : 10⁶

Power contactors	16 A and 25 A		
	24 VA	230 VA	230 VA
Control voltage	24 VA	230 VA	230 VA
Nominal current	16 - 25 A	16 - 25 A	16 - 25 A
Type of contact	N/O + N/C 2 N/O	N/O + N/C 2 N/O 2 N/C	2 N/O + 2 N/C 4 N/O 4 N/C
Number of modules	1	1	2
Holding	200 mA	20 mA	20 mA
Inrush	970 mA	90 mA	200 mA

Power contactors	40 A and 63 A	
	230 VA	230 VA
Control voltage	40 and 63 A	40 and 63 A
Nominal current	40 and 63 A	40 and 63 A
Type of contact	2 N/O	3 N/O 4 N/O
Number of modules	2	3
Holding	15 mA	30 mA
Inrush	150 mA	200 mA

Max. connection cross section in mm²

Type of conductor	Ratings ≤ 25 A	Ratings 40 and 63 A
Rigid	1 x 6 ² or 2 x 2.5 ²	1 x 25 ² or 2 x 10 ²
Flexible	1 x 6 ² or 2 x 2.5 ²	1 x 25 ² or 2 x 10 ²
Flexible with single ferrule	1 x 6 ²	1 x 16 ²
Flexible with double ferrule	2 x 4 ²	2 x 16 ²

push buttons/control switches and indicators

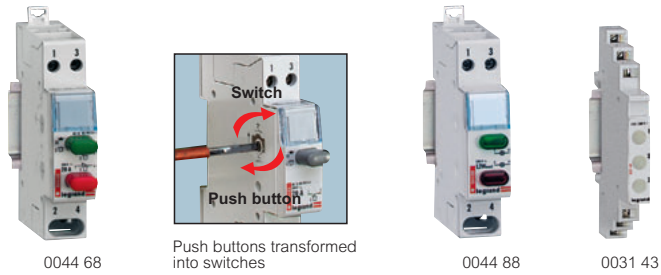

Dimensions (p. 117)

Conform to IEC 60669-1
 Breaking capacity AC 12 A according to IEC 60947-5-1
 Supplied in push button position
 Can be converted to control switches
 Accepts insertion of supply busbars
 IP 2x
 Class II

Pack	Cat. Nos.	Push buttons/control switches 20 A - 250 V \sim		Number of 17.5 mm modules
Single function				
10	0044 53	1 N/O		1
10	0044 54	1 N/C		1
10	0044 55	2 N/O		1
10	0044 58	1 N/O + 1 N/C		1
Dual function + indicator				
10	0044 63	1 N/O + green indicator Supplied with 230 V \sim E10 lamp		1
10	0044 64	1 N/C + red indicator ⁽¹⁾ Supplied with 230 V \sim E10 lamp		1
10	0044 68	1 N/O (green) + 1 N/C (red)		1

Pack	Cat. Nos.	Indicators - 250 V \sim		Number of 17.5 mm modules
Supplied with replaceable diffuser and lamp E10 - 230 V \sim Allow supply busbar to be inserted				
Single				
10	0044 83	Green		1
10	0044 84	Red		1
10	0044 85	Orange		1
10	0044 86	Blue		1
10	0044 87	Colourless		1
10	0044 88	Double Green + red		1
Three phase voltage indicator Supplied with 230/400 V \sim non-replacement lamps 3 colourless neon lamps				
2	0031 43			0.5

Pack	Cat. Nos.	Accessories
Replacement lamps E10 - 1.2 W		
10	0044 32	8/12 V incandescent
10	0044 33	24 V incandescent
10	0044 36	230 V neon
10	0044 37	230 V fluo for blue and green diffusers

transformers and buzzers

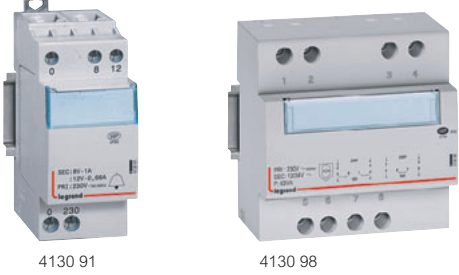

Technical information and dimensions (p. 117)

In the event of an overload, switch off the power supply and allow the transformer to cool down before switching on again
 Wall or rail mounted

Pack	Cat. Nos.	Bell transformers				Number of 17.5 mm modules
Conform to IEC/EN 61558-2-8 Supplied with label holder Protected against overloads and short circuits Power to 8 V-12 V or 24 V access control devices such as bells and chimes Possibility for supply busbars to run through (Cat. Nos. 4130 90/91)						
230 V / 8 V						
		Secondary (V)	Rating (A)	Power (VA)		
1	4130 90	8 V \sim	0.5 A	4 VA		2
230 V / 12 V - 8 V						
1	4130 91	12/8 V \sim	0.66/1 A	8 VA		2
230 V / 24 V - 12 V						
1	4130 93	24/12 V \sim	1/1.5 A	24/18 VA		4

Pack	Cat. Nos.	Safety transformers						Number of 17.5 mm modules
Conform to IEC/EN 61558-2-6 Supplied with label holder Protected against overloads and short circuits Power to 12 V or 24 V devices such as modular power contactors, latching relays and signalling units								
230 V / 12 or 24 V								
		P (VA)	No-load loss (W)	Voltage drop % Cos $\varphi = 1$	Efficiency % Cos $\varphi = 1$	Ucc (%)	I (A) primary loaded	
1	4130 95	16	2.5	34.6	60	27.5	0.10	4
1	4130 96	25	2.5	29	66	23.3	0.14	4
1	4130 97	40	4	17.9	68	14.4	0.22	5
1	4130 98	63	4	15.7	75	13.6	0.33	5

Pack	Cat. Nos.	Buzzers					Number of 17.5 mm modules
50 Hz AC Connection by screw terminals Equipped with label holder							
Caution : remove lamps from illuminated push buttons when used with Cat. No. 0041 11							
		Voltage (V \sim)	Power (VA)	Consum. (mA)	P ⁽¹⁾ (dB)		
5	0041 11	24	4	180	73		1
10	0041 13	230	4	21	73		1

(1) Acoustic power a 1 m

transformers and buzzers

■ Operating principle

Bell transformers

Safety isolating transformer with secondary voltage not permanently exceeding 24 V and for a non permanent usage

Power to 8 V-12 V or 24 V access control devices such as:

- bell
 - chime
 - door release
 - optical electrical barrier
- Also:
- flood detector
 - temperature rise detector

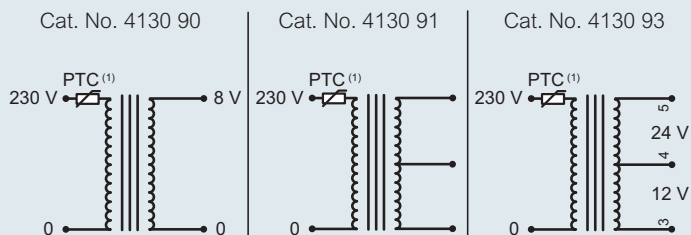

Safety transformers

Designed to protect people from electric shocks by using extra low voltage (ELV $U_{sec} \leq 50 V$)

Power to 12 or 24 V devices such as:

- relay
- modular power contactor
- signalling unit
- latching relay

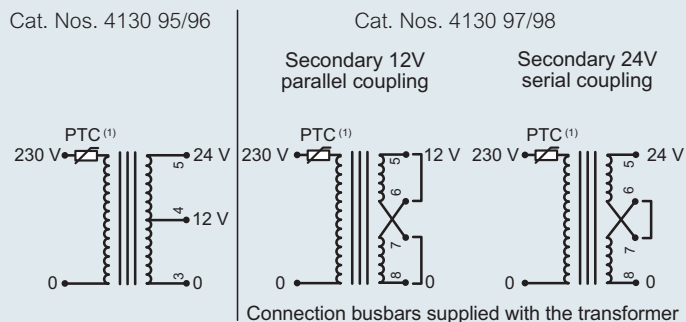

(1) PTC refer to general characteristics

■ Fixings

Wall or DIN rail \lrcorner 7.5 or 15 mm⁽²⁾ depth for 4 module units
 Rail DIN \lrcorner 7.5 or 15 mm⁽²⁾ depth for 2 and 5 module units

(2) Remove with tool

■ Connection

	Primary flexible or rigid	Secondary flexible or rigid
	1 to 4 mm ²	1 to 4 mm ²
	1 to 4 mm ²	1 to 4 mm ²

■ Equivalence chart

Old transformer range		New transformer range	
Cat. Nos.	Description	Cat. Nos.	Description
0042 20	Bell transformer 4 VA	4130 90	Bell transformer 4 VA
0042 25	Bell transformer 8 VA	4130 91	Bell transformer 8 VA
0042 37	Bell transformer 24/18 VA	4130 93	Bell transformer 24/18 VA
0042 51	Safety transformer 16 VA	4130 95	Safety transformer 16 VA
0042 52	Safety transformer 25 VA	4130 96	Safety transformer 25 VA
0042 53	Safety transformer 40 VA	4130 97	Safety transformer 40 VA
0042 54	Safety transformer 63 VA	4130 98	Safety transformer 63 VA

modular DIN rail equipment dimensions

■ Dimensions

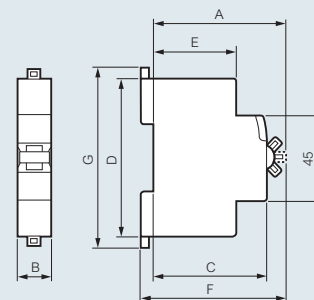

Description	Dimension (mm)									
	A	B				C	D	E	F	G
		1-pole	2-pole	3-pole	4-pole					
Isolating switches 20 - 32 A	68	17-7	17-7	35-6	53-4	60	83	44	74	94
63 - 100 - 125 A	68	17-7	35-6	53-4	71-2	60	83	44	74	94
Changeover switches Cat. Nos. 0043 82/85	68	17-7				60	83	44	74	94
Cat. No. 0043 83	68	35-6				60	83	44	74	94
Push buttons/control switches and indicators	68	17-7				60	83	44	74	94
Contactors $\leq 20 A$	62	17-8	17-8	35-6	35-6	60	83	44	67-5	94
Buzzers	60	17-5				60	76	44	66	85

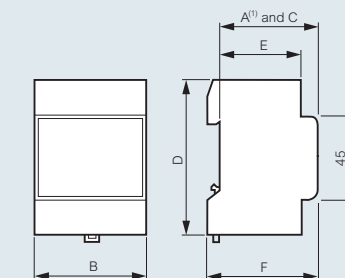

Description	Dimension (mm)						
	A ⁽¹⁾	B	C	D	E	F	
Contactors 40 and 63 A - 2 modules	62	35-6	60	83	44	68	
Contactors 40 and 63 A - 3 modules	62	53-4	60	83	44	68	
Auxiliaries for contactors 20 A	60	9	60	83	44	66	
Transformers	Cat. Nos. 4130 90/91	60	36	60	84	44	66
	Cat. No. 4130 93	60	72	60	84	44	66
	Cat. Nos. 4130 95/96	60	72	60	84	44	66
	Cat. Nos. 4130 97/98	60	89	60	95	44	66

(1) Maximum projection

Time switches... move with the times

Legrand's one and two channel time switches are available in digital and analogue versions, ranging from NEW AlphaRex³ programmable switches with 0.1 second clock precision, to a more simplistic analogue technology with basic switching functions.

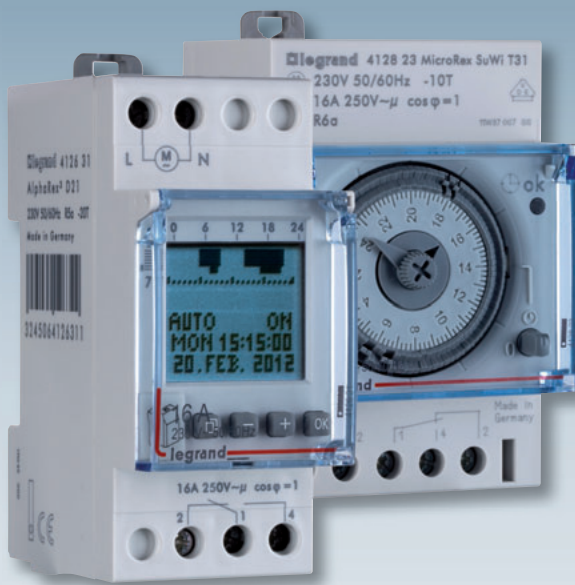

NEW AlphaRex³... the next generation of innovation

AlphaRex³ is the latest addition to the digital time switches range. Available in astronomical light control and standard versions, each with PC programmable functionality.

- **0.1 second clock precision** – unbeatable accuracy
- **Zero crossing switching** – reduces stress on the relay / increases longevity of time switch and lamp
- **Expanded offset programming** – ideal for outdoor signage and street lighting applications
- **Expanded cycle functions** – for non-lighting applications such as water features and water irrigation
- **Preset time and date** – no adjustment needed
- **High torque terminal blocks** – for enhanced safety
- **Pin code for weekly devices** – preventing unauthorised programming
- **Programme back-up via data key** – one key fits all devices



Programming made easy

AlphaRex³ can be programmed for standard applications using the push buttons on the device. More expert programming can be achieved either on site or remotely using a PC, data key and Legrand's patented programming software.





AlphaRex³ at a glance



Weekly time switch
1 + 2 channel
DIN rail mountable



Weekly time switch
with astronomical
functions
1 + 2 channel
DIN rail mountable



Yearly time switch
1 + 2 channel
DIN rail mountable

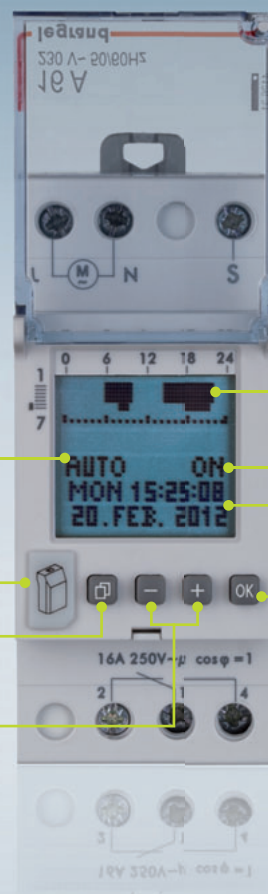

Operating mode

Data key

'MENU' - Launches
the programming mode

'+ / -' - Selects
program menus

Switching time overview

Switching state

Current time
and date

'OK' - Confirms the
selected program point

Also available

DIGITAL



MicroRex digital
time switches
DIN rail mountable
see p. 123



MaxiRex digital
time switches
Surface mounting
see p. 124

ANALOGUE



MicroRex analogue
time switches
DIN rail mountable
see p. 125



MaxiRex & EconoRex
analogue time switches
Surface / panel
mounting
see p. 126

LIGHTING CONTROL

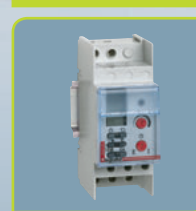

Light sensitive switch
For lighting control
see p. 127



Time lag switch
For lighting control
see p. 127

NEW

AlphaRex³ programmable time switches digital for rail



Technical information (p. 121)

Conform to EN 60730-1 and EN 60730-2-7
 Supply voltage : 230 V~ 50/60 Hz
 Mount on DIN rail EN 60715
 Text based programming. Programmable in 15 languages
 Programme directly on time switch keypad or remotely via a PC with Legrand AlphaSoft software, USB adaptor and data key
 Data key enables programmes to be transferred from one unit to another and for programmes to be stored
 EEPROM memory keeps programmes stored indefinitely
 Pin code facility to protect programmes from unauthorised changes
 Time switch accuracy : ±0.1 second per day
 Zero-crossing switching
 Automatic summer/winter time correction
 5 years running reserve
 Back lit graphic display and keypad
 Operating temperature : -20 °C to +55 °C
 Protection : IP 20
 Switching increment : 1 minute
 Shortest switching time : 1 minute

Pack	Cat. Nos.	AlphaRex ³	No. of 17.5 mm modules
1	4126 31	Weekly time switches 24h / 7 day programme time Particularly suited to irregular cycles (e.g. security installations and industrial installations) Random function to simulate presence - programmed switching cycles are shifted at random with a range of ±15 minutes Additional functions : Operating hours counter (for max. 65,535 hours) 1 hour test Cycle function Holiday programme AlphaRex D21 230 V 24 hr / 7 day single channel 1 x 16 A output 56 programmes	2
1	4126 41	AlphaRex D22 230 V 24 hr / 7 day two channel 2 x 16 A outputs 2 x 28 programmes	2

24 V and 120 V time switches available on request. Contact us on +44 (0) 845 605 4333

Pack	Cat. Nos.	Accessories
1	4128 72	Programming transfer key Enables programmes to be stored and / or transferred from one time switch to another when used with the programming software kit Cat. No. 4128 73 Data key can be stored directly within the time switch
1	4128 73	Programming software kit Create and read programmes remotely via a PC Transfer programmes via transfer key Cat. No. 4128 72 to time switches Kit comprises : AlphaSoft 4.0 software, data loader and transfer key Windows ^{®(1)} Vista compatible

(1) Windows is a registered trademark of the Microsoft Corporation

NEW

AlphaRex³ Astro programmable time switches light control – digital for rail



Technical information (p. 122)

Conform to EN 60730-1 and EN 60730-2-7
 Supply voltage : 230 V~ 50/60 Hz
 Mount on DIN rail EN 60715
 Text based programming. Programmable in 15 languages
 Programme directly on time switch keypad or remotely via a PC with Legrand AlphaSoft software, USB adaptor and data key
 Data key enables programmes to be transferred from one unit to another and for programmes to be stored
 EEPROM memory keeps programmes stored indefinitely
 Pin code facility to protect programmes from unauthorised changes
 Time switch accuracy : ±0.1 second per day
 Zero-crossing switching
 Automatic summer/winter time correction
 5 years running reserve
 Back lit graphic display and keypad
 Operating temperature : -20 °C to +55 °C
 Protection : IP 20
 Switching increment : 1 minute
 Shortest switching time : 1 minute

Pack	Cat. Nos.	AlphaRex ³ Astro light control	No. of 17.5 mm modules
1	4126 54	Weekly time switches 24h / 7 day programme time Particularly suited to outdoor lighting and street signage applications Enables the daily astronomical calculation of sunrise and sunset by inputting local position or coordinates (no need to install a light sensor) Lights are switched ON and OFF according to sunrise and sunset times, and can be offset by up to ±120 minutes in relation to sunrise and sunset times To save energy, it is also possible to programme an ON and OFF time at night Time saving programming due to pre-set groups of days : Mon-Sun, Mon-Fri, or Sat-Sun and individual selection of days Programmes are shown as a weekly matrix on the graphic display Additional functions : Operating hours counter (for max. 65,535 hours) 1 hour test Holiday programme AlphaRex Astro D21 230 V 24 hr / 7 day single channel 1 x 16 A output 56 programmes	2
1	4126 57	AlphaRex Astro D22 230 V 24 hr / 7 day two channel 2 x 16 A outputs 2 x 28 programmes	2

24 V and 120 V time switches available on request. Contact us on +44 (0) 845 605 4333

Pack	Cat. Nos.	Accessories
1	4128 72	Programming transfer key Enables programmes to be stored and / or transferred from one time switch to another when used with the programming software kit Cat. No. 4128 73 Data key can be stored directly within the time switch
1	4128 73	Programming software kit Create and read programmes remotely via a PC Transfer programmes via transfer key Cat. No. 4128 72 to time switches Kit comprises : AlphaSoft 4.0 software, data loader and transfer key Windows ^{®(1)} Vista compatible

(1) Windows is a registered trademark of the Microsoft Corporation

AlphaRex³ programmable time switches

digital for rail

■ Dimensions (mm)

Cat. Nos. 4126 31/41

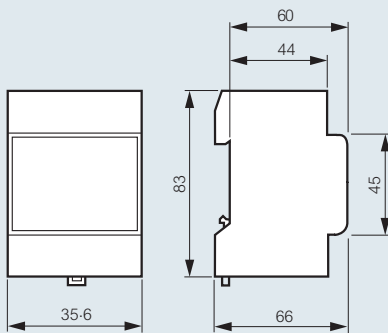

■ Wiring diagrams

Cat. No. 4126 31

Cat. No. 4126 41

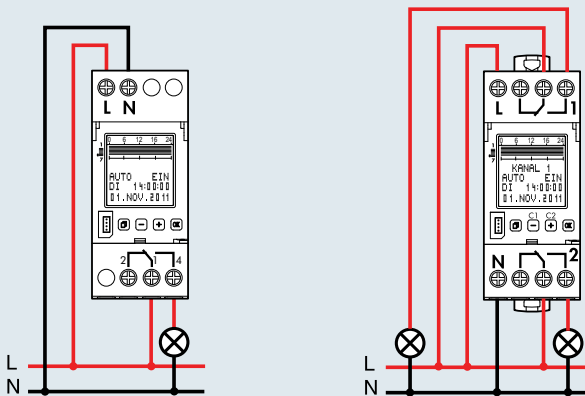

■ General information

AlphaRex³ D21 Cat. No. 4126 31

• **Start-up** : after applying the supply voltage, the time switch starts automatically with the last selected function. The relay position is set by the current programme

• **Battery backup**

- **Backlighting** not active
- **Data key** READ/WRITE only via the menu

Select menu, back to main menu, Hold down > 1s = operating display

Confirm selection or load parameters

Select menu options or set parameters

■ Technical information

Type Cat. No.	AlphaRex ³ D21 4126 31	AlphaRex ³ D22 4126 41
Supply voltage	230 V~	
Frequency	50/60 Hz	
Programme	24 hour or 7 day	
No. of channels	1	2
Effective power consumption	Approx 1 W	ca 1.5 W
Switching capacity : cos φ = 1	16 A 250 V~	
Contact	1 changeover switch	2 changeover switches
Parallel compensation	600 W max, 70µF	
Switching step	1 minute	
Min. switching time	1 minute	
Accuracy	±0.1 seconds per day	
Terminal capacity	Single strand 1.5 to 4mm ²	
Programmes	56	28 per channel
Working reserve ⁽¹⁾	6 years	
Battery reserve	5 years	
Programme memory	EEPROM	
Summer/Winter time	Auto	
IP rating	IP 20	
No. of 17.5 mm modules	2	
Operating temp.	-20 °C to +55 °C	
Storage temp.	-20 °C to +60 °C	

(1) For time and date only

AlphaRex³ D22 Cat. No. 4126 41

• **Start-up** : after applying the supply voltage, the time switch starts automatically with the last selected function. The relay position is set by the current programme

• **Battery backup**

- **Backlighting** not active
- **Data key** READ/WRITE only via the menu

• **For safety** : when the time switch is connected to the mains supply the contact should not be used on an isolated low voltage supply and when the time switch is connected to the isolated voltage supply the contact should not be used on the mains supply

Select menu, back to main menu, Hold down > 1s = operating display

Confirm selection or load parameters

C1 C2
 Select menu options or set parameters
 Channel selection

AlphaRex³ Astro programmable time switches

light control – digital for rail

■ Dimensions (mm)

Cat. Nos. 4126 54/57

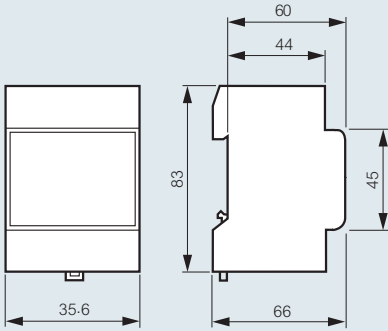

■ Wiring diagrams

Cat. No. 4126 54

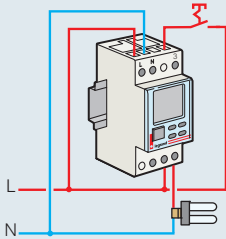

Cat. No. 4126 57

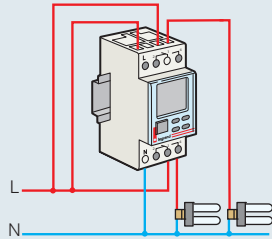

Output closing and breaking times are calculated based on the date, the actual time when the device was switched and on geographical coordinates of the actual location

Cat. No. 4126 54

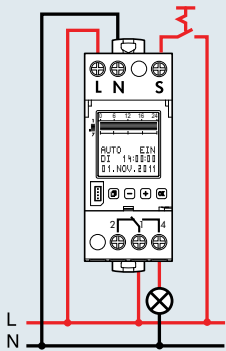

Cat. No. 4126 57

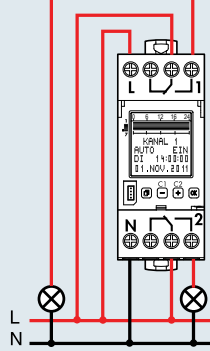

■ General information

AlphaRex³ Astro D21 Cat. No. 4126 54

- **Start-up** : after applying the supply voltage, the time switch starts automatically with the last selected function. The relay position is set by the current programme
- **Battery backup**
 - **Backlighting** not active
 - **Data key** READ/WRITE only via the menu

Select menu, back to main menu, Hold down > 1s = operating display

Confirm selection or load parameters

Select menu options or set parameters

■ Technical information

Type Cat. No.	AlphaRex ³ Astro D21 4126 54	AlphaRex ³ Astro D22 4126 57
Supply voltage	230 V~	
Frequency	50/60 Hz	
Programme	24 hour or 7 day	
No. of channels	1	2
Effective power consumption	1 W	1.5 W
Switching capacity : cos φ = 1	16 A 250 V~	
Contact	1 changeover switch	2 changeover switches
Min. prog. setting	1 second	
Accuracy	±0.1 seconds per day	
Terminal capacity	Single strand 1.5 to 4mm ²	
Programmes	56	28 per channel
Control-cable length	Max. 50 m	
Control signal	230 V AC/2 mA	
Control-pulse duration	100 to 200 ms	
Delaytime	0 to 23 h 59 min 59 s	
Local coordinates	Resolution 1°/1' in EXPERT-Mode	
Working reserve ⁽¹⁾	6 years	
Battery reserve	5 years	
Programme memory	EEPROM	
Summer/Winter time	Auto	
IP rating	IP 20	
No. of 17.5 mm modules	2	
Operating temp.	-20 °C to +55 °C	
Storage temp.	-20 °C to +60 °C	

(1) For time and date only

AlphaRex³ Astro D22 Cat. No. 4126 57

- **Start-up** : after applying the supply voltage, the time switch starts automatically with the last selected function. The relay position is set by the current programme

- **Battery backup**
 - **Backlighting** not active
 - **Data key** READ/WRITE only via the menu

- **For safety** : when the time switch is connected to the mains supply the contact should not be used on an isolated low voltage supply and when the time switch is connected to the isolated voltage supply the contact should not be used on the mains supply

Select menu, back to main menu, Hold down > 1s = operating display

Confirm selection or load parameters

Select menu options or set parameters
 Channel selection

MicroRex D digital time switches for rail



MicroRex D digital time switches for rail



6047 74



0037 00

Conform to EN 60730-1 and EN 60730-2-7
LCD digital display
Mount on DIN rail EN 60715

Pack	Cat. Nos.	MicroRex D Plus	No. of 17.5 mm modules
		UK specific English display Supply voltage : 220 V~ 50 Hz CE approved 16 A 56 programmes per channel 3 years working reserve Accuracy : 1 second clock precision Switching precision : 1 minute	
		MicroRex D21 Plus 1 channel	2
		MicroRex D22 Plus 2 channels	2

NEW
Available September 2012

Pack	Cat. Nos.	MicroRex D Plus	No. of 17.5 mm modules
		Working reserve : 6 years Accuracy : ±1 second per day Programmable for 1 minute minimum at 1 minute steps either as 24 hour/7 day using pre-set groups of days	
		MicroRex D21 Plus 24 hour or 7 day, 28 programme 1 channel 1 x 16 A voltage free c/o contact	2
		MicroRex D22 Plus 24 hour or 7 day, 2 x 14 programme 2 channel 2 x 16 A voltage free c/o contacts	2

Available
Until September 2012

Pack	Cat. Nos.	MicroRex D	No. of 17.5 mm modules
		Supply voltage : 230 V~ 50/60 Hz Working reserve : 100 hours Accuracy : ±2.5 seconds per day 7 day programme Programmable for 1 minute min. at 1 minute steps Additional features : Manual advance/override (ON-OFF) Automatic override (ON-OFF) for holidays, weekends or bank holidays up to 99 days successively Automatic summer/winter setting	
		MicroRex D11 – 1 module 8 programmes 1 channel 1 x 16 A – 250 V~ voltage free c/o contacts with 8 “ON-OFF” per day or per week	1

Technical information

Type Cat. No.	MicroRex D21 Plus 6047 74	MicroRex D22 Plus 6047 77	MicroRex D11 0037 00
Programme	24 hour or 7 day		7 day
No. of channels	1	2	1
No. of ON-OFF actions per day/week	28	2 x 14	8
Switching cap : cos φ = 1 incandescent lamp cos φ = 0.6	16 A 5 A 8 A		16 A 4 A 10 A
Contact	1 c/o	2 c/o	1 c/o
Terminal capacity	1.5 - 4 mm single/1.5 - 2.5 mm stranded		
IP rating	IP 20		
Min. prog. time	1 minute		
Switching step	1 minute		
Accuracy	±1 second per day		±2.5 sec/d
Working reserve⁽¹⁾	6 years		>100 hrs
Prog. memory	EEPROM		-
Manual switching	Override and permanent		
No. of 17.5 mm modules	2		1
Operating temp.	-20 °C to +55 °C		-10 °C to +55 °C
Storage temp.	-20 °C to +60 °C		-
Weight	130 g		100 g

(1) For time and date only

Dimensions (mm) and wiring diagrams

MicroRex D21/D22 Plus

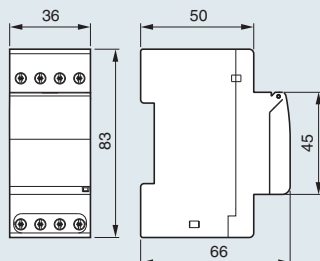

Wiring diagram

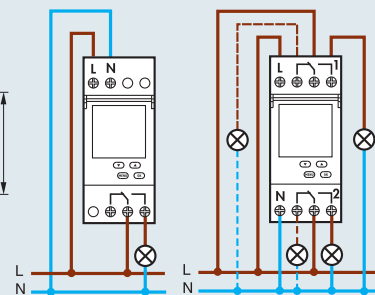

MicroRex D11

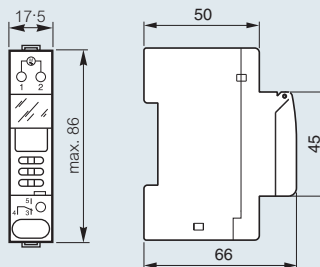

Wiring diagram

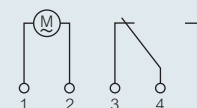

MaxiRex digital time switches

surface or 72 x 72 mm panel mounting



MaxiRex digital time switches

surface or 72 x 72 panel mounting



0496 82

Conform to EN 60730-1 and EN 60730-2-7
 Supply voltage : 230 V~ 50/60 Hz
 Accuracy : ±1 second per day
 LCD digital display
 Programmable for 1 minute minimum at 1 minute intervals
 Panel and DIN rail mounting :
 - can be panel mounted using Cat. No. 0498 32
 - can be clipped to DIN rail using Cat. No. 0044 09

Pack	Cat. Nos.	MaxiRex D Plus
		Working reserve : 6 years Programmable for 1 minute min. at 1 minute steps either as 24 hour/7 day using pre-set groups of days One programme consists of 1 "ON" and 1 "OFF" time and the allocation of any day of the week or a combination of days. Plus the selected channel Example : Prog. 1 On 07.00hrs Off 08.15hrs Mon-Fri Ch1 Prog. 2 On 16.00hrs Off 20.15hrs Mon-Fri Ch2 Prog. 3 On 10.00hrs Off 16.15hrs Sat-Sun Ch1 Additional features : EEPROM memory stores programme indefinitely Optional automatic summer/winter time change Manual override (ON or OFF) Automatic advance (changes contact position until next automatic ON time)
1	0496 80	MaxiRex D72/1 Plus 24 hour or 7 day 28 programme 1 channel 1 x 16 A voltage free c/o contact
1	0496 82	MaxiRex D72/2 Plus 24 hour or 7 day 2 x 14 programme 2 channel 2 x 16 A voltage free c/o contacts

Pack	Cat. Nos.	Fixing accessories
5	0498 32	Clip-on support frame for panel mounting
5	0044 09	DIN rail adaptor

Technical information

Type Cat. No.	MaxiRex D72/1 Plus 0496 80	MaxiRex D72/2 Plus 0496 82
Programme	24 hour or 7 day	
No. of channels	1	2
No. of ON-OFF actions per day	28	2 x 14
Switching capacity : cos φ = 1 incandescent lamp cos φ = 0.6	16 A 5 A 8 A	16 A 5 A 8 A
Contact	1 changeover switch	2 changeover switches
Min. prog. time	1 minute	
Switching step	1 minute	
Accuracy	±1 second per day	
Working reserve ⁽¹⁾	6 years	
Programme memory	EEPROM	
Manual switching	Override and permanent	
Operating temp.	-20 °C to +55 °C	
Storage temp.	-20 °C to +60 °C	
Weight	178 g	204 g

(1) For time and date only

Dimensions (mm)

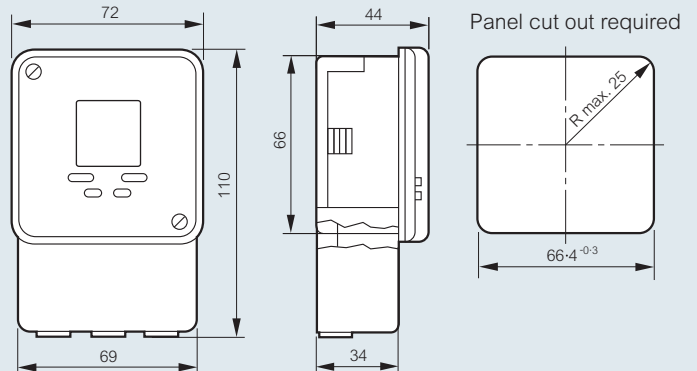

Wiring diagrams

MaxiRex D72/1 Plus

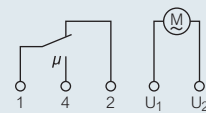

MaxiRex D72/2 Plus

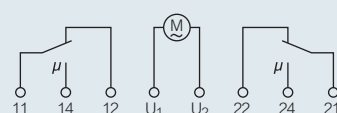

MaxiRex D72/2 Plus

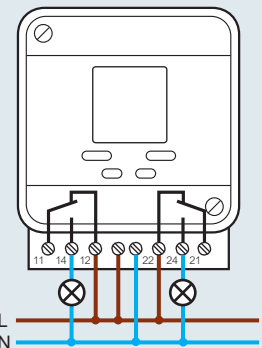

Mounting options

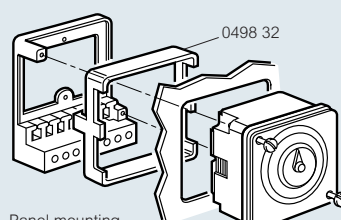

Panel mounting with support Cat. No. 0498 32 to be ordered separately

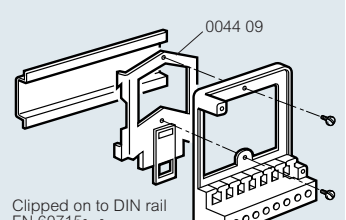

Clipped on to DIN rail EN 60715 Adaptor to be ordered separately (Cat. No. 0044 09)

MicroRex analogue time switches for rail

NEW



4127 90

4127 95

Conform to EN 60730-1 and EN 60730-2-7
 Programmed via captive segment
 Supply voltage : 230 V~ 50/60 Hz
 1 x 16 A output
 Manual changeover to summer/winter time
 Mount on DIN rail EN 60715

Pack	Cat. Nos.	Daily programme
1	4127 80	24 hour programme One segment : 15 minutes Switching accuracy : ± 5 minutes T11 Daily 1 channel Without working reserve N/O contact Minimum switching time : 15 minutes Vertical dial
1	4127 90	QT11 Daily 1 channel With 100 hr working reserve N/O contact Minimum switching time : 15 minutes Vertical dial
1	4128 12	T31 Daily 1 channel Without working reserve Changeover switch Minimum switching time : 30 minutes Horizontal dial
1	4128 13	QT31 Daily 1 channel With 100 hr working reserve Changeover switch Minimum switching time : 30 minutes Horizontal dial
Weekly programme		
1	4127 94	7 day programme One segment : 2 hours Switching accuracy : ± 30 minutes QW11 Weekly With 100 hr working reserve N/O contact Minimum switching time : 2 hours Vertical dial
1	4127 95	QW31 Weekly With 100 hr working reserve Changeover switch Minimum switching time : 4 hours Horizontal dial

No. of 17.5 mm modules
1

1

3

3

No. of 17.5 mm modules
1

3

MicroRex analogue time switches for rail

Technical information

Cat. Nos.	Programme	Segment	Min. switching time	Working reserve	16 A output via contact		No. of modules
					N/O	Chang. S.	
4128 12	24 h	15 min	30 min	without	-	1	3
4128 13	24 h	15 min	30 min	100 h	-	1	3
4127 80	24 h	15 min	15 min	without	1	-	1
4127 90	24 h	15 min	15 min	100 h	1	-	1
4127 94	7 d	2 h	2 h	100 h	1	-	1
4127 95	7 d	2 h	4 h	100 h	-	1	3

Wiring diagrams

Cat. Nos. 4127 80/90/94

Cat. Nos. 4128 12/13/95

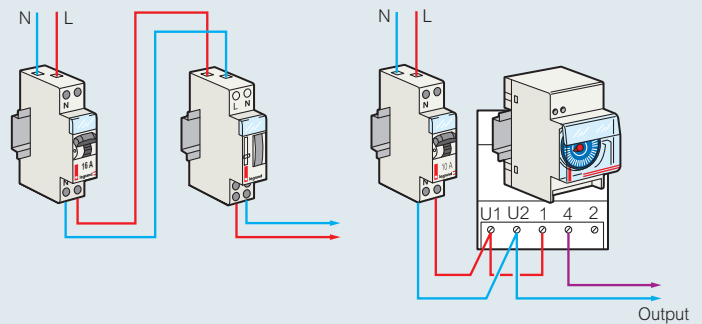

Output closing and breaking times are calculated based on the date, the actual time when the device was switched and on geographical coordinates of the actual location

Dimensions (mm)

Cat. Nos. 4127 80/90/94

Cat. Nos. 4128 12/13/95

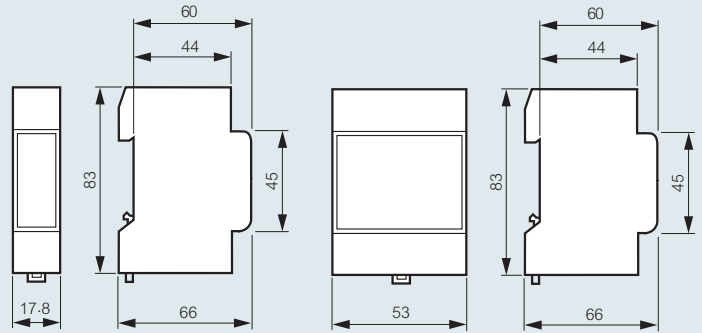



MaxiRex and EconoRex analogue time switches surface and panel mounting



0497 54



0499 83

Pack	Cat. Nos.	MaxiRex
		<p>Conform to EN 60730-1 and EN 60730-2-7 Supply voltage : 230 V\sim \pm10% 3 position changeover switch With manual override Voltage free contacts Mounting options : - can be surface mounted - can be panel mounted using Cat. No. 0498 32 - can be clipped to DIN rail using Cat. No. 0044 09</p> <p>With 72 x 72 mm display to DIN EN 60715 Part C</p> <p>24 hour programme Programmable for 30 minutes minimum at 10 minute intervals Accuracy : \pm5 minutes per day</p>
1	0497 50	<p>MaxiRex T Without working reserve – 50 Hz</p>
1	0497 54	<p>MaxiRex QT With 100 hr working reserve – 50/60 Hz</p> <p>7 day programme Programmable for 3 hours minimum at 1 hour intervals Accuracy : \pm30 minutes per day</p>

Fixing accessories		
5	0498 32	Clip-on support frame for panel mounting
5	0044 09	DIN rail adaptor

EconoRex MT		
		<p>Conforms to EN 60730-1 and EN 60730-2-7 Supply voltage : 230 V\sim 50 Hz Mounting options : - can be surface mounted using Cat. No. 0495 94 - can be panel mounted</p>
1	0499 83	<p>EconoRex MT BTAP without working reserve 20 A output Shortest switching step : 20 minutes Switching accuracy : \pm 5 minutes</p>

Fixing accessory		
1	0495 94	Support frame for surface mounting



Time switches are ideal for use
with Bticino door entry systems

Contact us on +44 (0) 845 605 4333

MaxiRex and EconoRex analogue time switches surface and panel mounting

Technical information

Type Cat. No.	MaxiRex T 0497 50	MaxiRex QT 0497 54	EconoRex MT 0499 83
Supply voltage	230 V \sim +10% -15%		
Frequency	50 Hz	50/60 Hz	50 Hz
Switching capacity : cos ϕ = 1 cos ϕ = 0.6 incand. lamp	16 A 10 A 1 000 W		16 A 8 A 1 000 W
Contact	1 c/o SPDT	1 c/o SPDT	1 c/o
Working reserve	None	100 hrs	None
Min. switching time	30 mins		15 mins
Interval	10 mins		15 mins
IP rating	IP 30		
Storage temp.	-10 °C to +60 °C		
Operating temp.	0 °C to +55 °C		

Dimensions (mm)

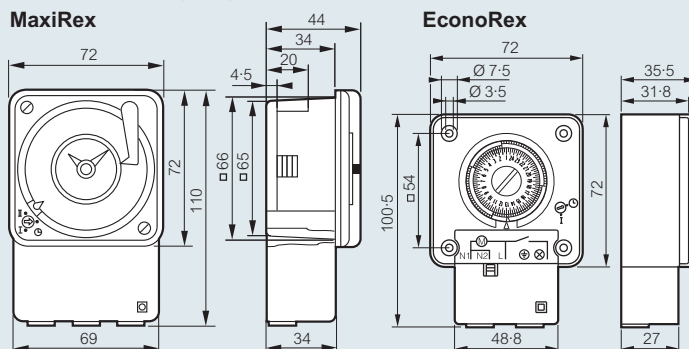

MaxiRex mounting

Wall mounting

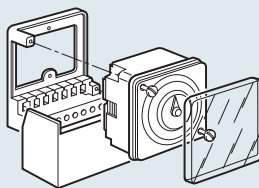

Panel mounting

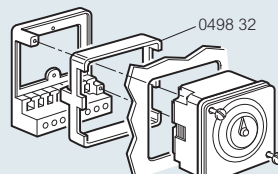

Panel mounting with support
Cat. No. 0498 32
to be ordered separately

DIN rail mounting

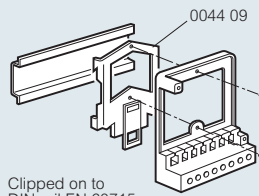

Clipped on to
DIN rail EN 60715
Adaptor to be ordered
separately (Cat. No. 0044 09)

Wiring diagrams

MaxiRex and EconoRex

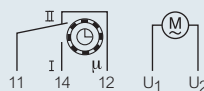

EconoRex mounting

Wall mounting

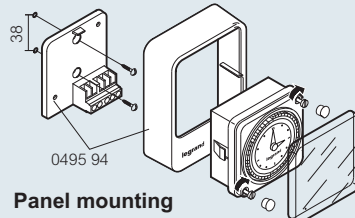

Panel mounting

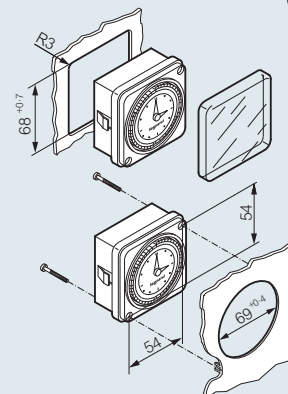

light sensitive control and electronic time lag switches

digital for rail



light sensitive control and electronic time lag switches

digital for rail



0037 21



4126 02

Pack	Cat. Nos.	Light sensitive switch Microlux D	No. of 17.5 mm modules
1	0037 21 ⁽¹⁾	<p>Controls lighting according to the time and light level Supply voltage : 230 V\sim \pm10% 50/60 Hz Working reserve : 100 hours Accuracy of time switch : 1 second per day Number of programmes : 28/14 per channel Range of light intensity : 2-60 000 Lux Switching step : 1 minute Manual switch : override/programme/stop Automatic changeover to summer/winter time Temporary override with automatic return to programme</p> <p>Microlux D 10 A - 250 V\sim $\cos \varphi = 1$ 1 changeover contact with 60 sec delay</p>	2

Pack	Cat. Nos.	Electronic time-lag switch	No. of 17.5 mm modules
10	4126 02	<p>For staircase lighting. Switches a lighting circuit on and off from remote switch for a specific time DIN rail mountable Self-protection in the event of a blocked push button</p> <p>Power supply : 230 V\sim - 50/60 Hz 2 000 W incandescent 2 000 W halogen - 230 V\sim 1 000 VA fluo-series compensated 120 VA fluo-parallel compensated 14 μF 100 VA compact fluorescent 1 000 W energy saving lamp Adjustable from 0.5 seconds to 10 minutes</p> <p>Output : 16 A - 250 V\sim - $\cos \varphi = 1$ 3 wire or 4 wire connection Manual override contact</p>	1

Technical information

Type Cat. No.	Microlux D 0037 21	Electronic time-lag 4126 02
Supply voltage	230 V \sim	
Frequency	50/60 Hz	
Consumption	~1.3 W	0.8 W
Contact rating	Changeover contact 10 A 250 V \sim $\mu \cos \varphi = 1$	μ 16 A $\cos \varphi = 1/250$ V \sim
Accuracy	\pm 2.5 seconds per day	
Terminal capacity	Single strand 1.5 to 4 mm ²	Multi strand 1.5 to 2.5 mm ²
Program pictures	8	
Battery reserve	100 hours	100 minutes
Operating temp.	-10 °C to +55 °C	-20 °C to +55 °C
Storage temp.	-10 °C to +60 °C	-20 °C to +70 °C
Setting range	~2 to 60 000 lx	
IP rating	IP 20	IP 30

Microlux D

Dimensions (mm)

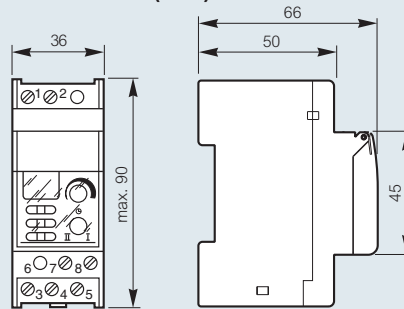

Wiring diagram

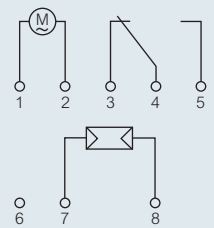

Connection of programmable light sensitive switch

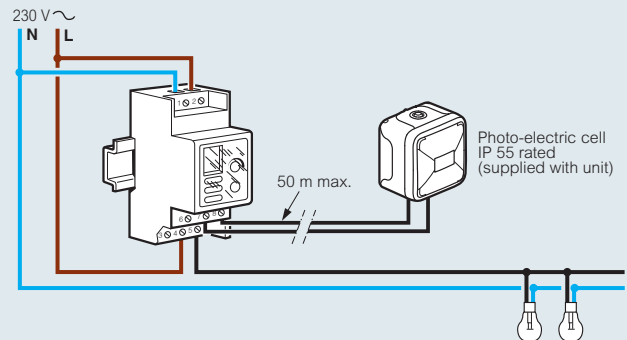

Lighting control without separate sensors?
 No problem for AlphaRex³ Astro time switch, see p. 120

Time-lag switch

- Allows :
- unlimited numbers of unlit push-buttons
 - 50 lit push-buttons max. (neon R = 1 mA max.)
- Constant lighting possible

3-wire connection

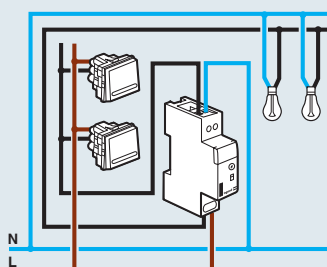

4-wire connection

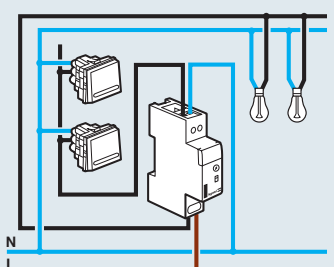

(1) Supplied with photo-electric cell housed in Plexo weatherproof box - IP 55



Viking 3 terminal blocks

Viking 3



P. 132
Terminal blocks –
screw connection
selection chart



P. 136
Terminal blocks –
spring connection
selection chart



P. 146
Terminal blocks –
heavy duty
selection chart

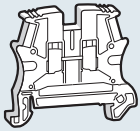

P. 134
Terminal blocks –
screw
connection

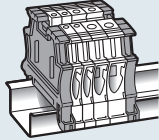

P. 140
Accessories for
terminal blocks



P. 142
Technical
information

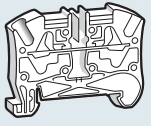

P. 138
Terminal blocks –
spring
connection

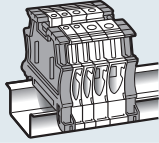

P. 140
Accessories for
terminal blocks



P. 144
Technical
information

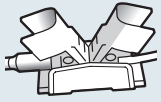

P. 147
Heavy duty
terminal blocks
for copper and
aluminium cables

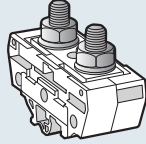

P. 148
Heavy duty
terminal blocks
for copper bars
and cable lugs



P. 149
Technical
information

Viking 3 terminal blocks...

fast, secure connections every time

Available with a choice of screw, spring and heavy duty connection options, Viking 3 terminal blocks provide trusted, safe and reliable installations whatever your application.

Terminal blocks in the screw and spring connection ranges are complemented by a range of common accessories, including end stops, dividers and bridging combs.

Used in conjunction with Legrand's CAB 3 marking system and Starfix ferrules and crimping tools, Viking 3 provides a total solution for easy to use connection systems.

SCREW CONNECTION



Universal screw technology, ideal for distribution and process cabinets.

FEATURES -

- Cable capacities from 0.25mm² to 95mm²
- High quality steel clamp ensures mechanical strength
- Angled cable entries for easy cabling and visible cable marking
- 2 central shunting zones
- Supplied pre-assembled in blocks of 5 or 10, using fixing pin
- 2 marking zones

SPRING CONNECTION



Ideal for vibration sensitive environments such as cranes, machines and onboard cabinets.

FEATURES -

- Cable capacities from 0.5mm² to 16mm²
- Angled cable entries for easy cabling and visible cable marking
- Direct insertion of rigid cable, or flexible cable with ferrules, in terminal blocks up to 6mm²
- 2 central shunting zones
- Reduced cabling time
- Automatic connection with or without ferrules
- 2 marking zones
- No regular retightening required
- 5mm pitch block facilitates 4mm cable

TECHNICAL DATA

APPROVALS: Conform to EN 60947-7-1, EN 60947-7-2, EN 60947-7-3, UL/CSA/NF/VDE/IMQ ATEX certification

SIZE RANGE: To fit cable cross sections from 0.25mm² to 300mm²

FLAMMABILITY: UL94, self extinguishing at 960°C



HEAVY DUTY CONNECTION



Enables copper and aluminium cables with cross sections from 35mm² to 300mm² to be connected directly or via lugs.

FEATURES -

- Multiple mounting options... DIN rail, G rail or plate fixing
- Compatible with CAB3 marking system
- Sealable to create weatherproof connections
- Separation barriers and protective covers available
- Provide facility for the termination of larger cables associated with long cable runs

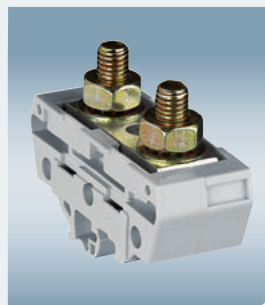

Integrated accessories complete the range



End stop with screwless fixing

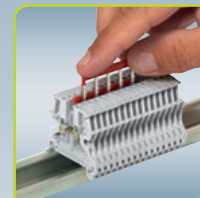

Bridging comb with automatic insertion up to 8 mm (screw) or 12 mm (spring) widths

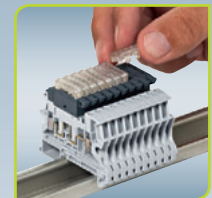

Indication of blown fuses (12 / 48 V or 110 / 250 V)



Additional functions can be added: standard, neutral or protected isolation, MCBs, automotive-type fuses, etc...

Common accessories across screw and spring connection ranges

Perfect connections...

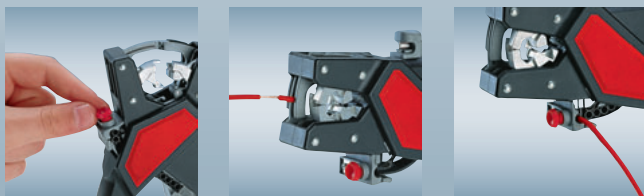

Create reliable connections in seconds with Starfix crimping tools and ferrules... everything you need for cable widths from 0.25mm² to 50mm².

See p. 160 to 161

clearly marked



CAB 3 offers a high quality solution to multiple cable and terminal block marking needs. Universal fittings enable clear, rapid marking and simple modification.

See p. 152 to 156

Viking 3 terminal blocks – screw connection for copper cable



See p. 134-135 for product detail

TERMINAL TYPE

0371 61 0371 63 0371 64 0371 66 0371 69 0371 68 0371 00 0371 08 0371 20 0371 30	<p>Connection (p. 134)</p>	<p>1 connection - 1 entry/1 exit</p> <p>1 connection - 2 entries/2 exits</p> <p>2 connections on 2 levels</p> <p>3 connections on 3 levels</p>		
0371 71 0371 76 0371 78 0371 79	<p>Protection (p. 134)</p>	<p>1 connection - 1 entry/1 exit - metal base</p> <p>1 connection - 1 entry/1 exit - plastic base⁽¹⁾</p> <p>1 connection - 2 entries/2 exits - metal base</p>		
0371 80 0371 81 0371 84 0371 86 0371 87	<p>Disconnection (p. 134)</p>	<p>1 connection</p> <p>Open (to be equipped)</p> <p>For fuse cartridge 5 x 20 with handle lever</p> <p>For fuse cartridge 5 x 20 with handle lever + blown fuse indicator</p> <p>For neutral circuit with handle lever</p> <p>For standard circuit</p> <p>For circuit not broken</p> <p>For fuse cartridge 5 x 20 with screwed plug</p>	<p>With handle lever</p> <p>With mini lever</p> <p>With handle lever</p> <p>With mini lever</p>	
0371 51 0371 52	<p>For sensors and actuator (p. 135)</p> <p>PNE (p. 135)</p>	<p>3 connections on 3 levels</p> <p>Sensor</p> <p>Actuator</p> <p>Phase/Neutral/Earth</p>		

(1) Can be used for protection conductor inside class II equivalent assemblies
 (2) Blown fuse indicator 12/24/48 V ~ / ~ Cat. No. 0375 24 or 110/250 V ~ Cat. No. 0375 25 (p. 141)
 (3) Or end stop Cat. No. 0375 10

(4) Upper level only
 (5) Lower and intermediate levels

accessories

for Viking 3 terminal blocks - screw connection

TERMINAL BLOCK				INSULATION		BRIDGING COMBS					PROTECTION		MEASURE- MENT	ASSOCIATED PRODUCTS
Nominal cross section (mm ²)	Width (mm)	Colour	Cat. Nos.	End cap	Separation / insulation divider	Comb for 2 blocks, auto. front	Comb for 3 blocks, auto. front	Comb for 10 blocks, auto. front	Comb for 12 blocks, side	Bar for 12 blocks, front	Single pole screen	Cut to length screen	Test meter adaptor	
2.5	5		0371 60	0375 50 ⁽³⁾	0375 60	0375 02	-	0375 01	-	-	0375 65	0375 68	0375 27	 End stops (p. 140)
			0371 00											
			0371 20											
4	6		0371 61	0375 50 ⁽³⁾	0375 60	0375 05	-	0375 04	-	-	0375 65	0375 68	0375 27	 Label holder for end stop (p. 140)
			0371 01											
			0371 21											
			0371 31											
6	8		0371 62	0375 50 ⁽³⁾	0375 60	-	0375 07	-	-	-	0375 66	0375 68	0375 27	
			0371 02											
10	10		0371 63	0375 50 ⁽³⁾	0375 60	-	-	-	-	0375 40	0375 66	0375 68	-	
			0371 03											
16	12		0371 64	0375 51	0375 61	-	-	-	-	0375 42	0375 67	0375 69	-	 End caps (p. 140)
			0371 04											
35	15		0371 65	0375 51	0375 61	-	-	-	-	0375 44	0375 67	0375 69	-	
			0371 05											
70	22		0371 66	built-in	-	-	-	-	-	-	-	-	-	-
			0371 06											
4	6		0371 69	0375 52	0375 62	0375 05	-	0375 04	-	-	-	-	0375 27	
			0371 09											
2.5	5		0371 67	0375 53	0375 63	0375 02	-	0375 01	-	-	-	-	0375 27 ⁽⁴⁾	
			0371 07											
4	6		0371 68	0375 53	0375 63	0375 05	-	0375 04	-	-	-	-	0375 27 ⁽⁴⁾	 Dividers (p. 140)
			0371 08											
2.5	5		0371 51	0375 54	0375 54	0375 02 ⁽⁴⁾	-	0375 01 ⁽⁴⁾	0375 46 ⁽⁵⁾ 0375 47 ⁽⁶⁾	-	-	-	0375 27 ⁽⁴⁾	
			0371 52											
2.5	5		0371 70	0375 50 ⁽³⁾	-	-	-	-	-	-	-	-	-	
			0371 71											
			0371 72											
			0371 73											
			0371 74											
			0371 75											
			0371 76											
4	6		0371 77	0375 50	0375 60	0375 05	-	0375 04	-	-	0375 65	0375 68	-	 Blown fuse indicators (p. 141)
			0371 78											
6	8		0371 78	0375 50	0375 60	-	0375 07	-	-	-	0375 66	0375 68	-	
			0371 78											
4	6		0371 79	0375 52	-	-	-	-	-	-	-	-	-	
			0371 79											
2.5	6		0371 80	0375 55	0375 62	0375 05	-	0375 04	-	-	-	-	0375 27	 Shielding (p. 141)
			0371 81											
			0371 81 + 0375 24 / 25 ⁽²⁾											
			0371 82											
			0371 83											
			0371 84											
			0371 85											
			0371 86											
			0371 87											
			0371 87											
10	12		0371 87	0375 56	-	-	-	-	-	-	-	-	-	
			0371 87											
2.5	5		0371 51	0375 54	0375 54	0375 02 ⁽⁴⁾	-	0375 01 ⁽⁴⁾	0375 46 ⁽⁵⁾ 0375 47 ⁽⁶⁾	-	-	-	0375 27 ⁽⁴⁾	 Starfix ferrules (p. 160)
			0371 52											

Viking 3 terminal blocks – screw connection for copper cable

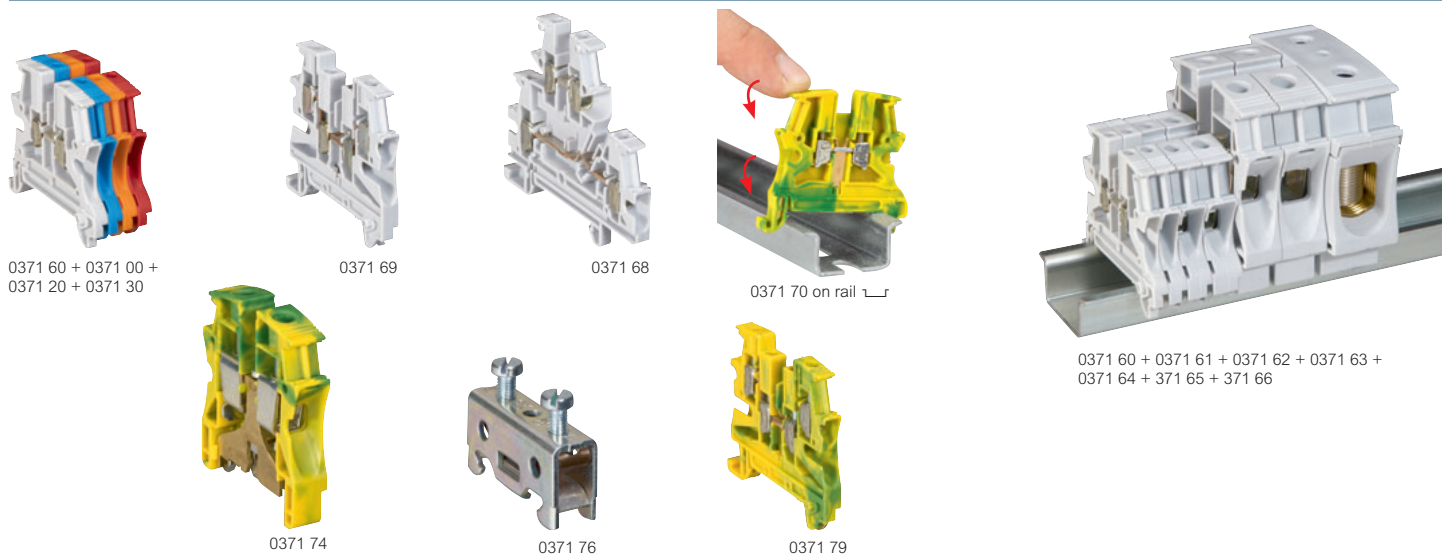

Accessories (p. 140-141)
Technical characteristics (p. 142-143)

All V2 polyamide UL94 960 °C to IEC EN 60695-2-11
Compatible with either rigid (0.25 mm² to 95 mm²) or flexible (0.25 mm² to 70 mm²) copper cables
Facility for 2 bridging combs
Compatible with rails depth 15 mm and rails EN 60715 depth 7.5 mm and 15 mm
Range comprises only 2 block heights (2.5 mm² to 10 mm² and 16 mm² to 70 mm²) ensuring a neat installation

Pack	Cat. Nos.	Connection	Capacity			Width (mm)
			Nominal cross section (mm ²)	Rigid cable (mm ²)	Flexible cable (mm ²)	
		Grey for standard circuit Blue for neutral conductor Orange for circuit not broken by the master isolating device Red for special circuits (safety, protected, etc)				
		1 connection - 1 entry/1 exit				
60	0371 60	Grey ●	2.5	0.25 to 4	0.25 to 2.5	5
60	0371 00	Blue ●				
60	0371 20	Orange ●				
60	0371 30	Red ●				
50	0371 61	Grey ●	4	0.25 to 6	0.25 to 4	6
50	0371 01	Blue ●				
50	0371 21	Orange ●				
50	0371 31	Red ●				
40	0371 62	Grey ●	6	0.5 to 10	0.25 to 6	8
40	0371 02	Blue ●				
30	0371 63	Grey ●	10	1.5 to 16	2.5 to 10	10
30	0371 03	Blue ●				
20	0371 64	Grey ●	16	1.5 to 25	4 to 16	12
20	0371 04	Blue ●				
20	0371 65	Grey ●	35	2.5 to 50	4 to 35	15
20	0371 05	Blue ●				
10	0371 66 ⁽¹⁾	Grey ●	70	25 to 95	16 to 70	22
		1 connection - 2 entries/2 exits				
25	0371 69	Grey ●	4	0.25 to 6	0.25 to 4	6
25	0371 09	Blue ●				
		2 connections on 2 levels				
60	0371 67	Grey ●	2.5	0.25 to 4	0.25 to 2.5	5
60	0371 07	Blue ●				
60	0371 68	Grey ●	4	0.25 to 6	0.25 to 4	6
60	0371 08	Blue ●				
		3 connections on 3 levels				
50	0371 51 ⁽²⁾	Grey ●	2.5	0.25 to 4	0.25 to 2.5	5

(1) Built-in end cap
(2) Cable capacity : 2.5 mm² max. only when used with bridging comb

Pack	Cat. Nos.	Protection	Capacity			Width (mm)
			Nominal cross section (mm ²)	Rigid cable (mm ²)	Flexible cable (mm ²)	
		1 connection - 1 entry/1 exit - metal base Screwless fixing on rail up to 10 mm width PEN from 10 mm ²				
60	0371 70	Green/yellow ●	2.5	0.25 to 4	0.25 to 2.5	5
50	0371 71	Green/yellow ●				
40	0371 72	Green/yellow ●				
30	0371 73	Green/yellow ●				
10	0371 74	Green/yellow ●				
10	0371 75	Green/yellow ●	35	2.5 to 50	4 to 35	15
		1 connection - bare block - metal base				
10	0371 76	-	35	2.5 to 50	4 to 35	15
		1 connection - 2 entries/2 exits - metal base Screwless fixing on rail				
50	0371 79	Green/yellow ●	4	0.25 to 6	0.25 to 4	6
		1 connection - 1 entry/1 exit - plastic base Can be used for protection conductor inside class II equivalent assemblies				
50	0371 77	Green ●	4	0.25 to 6	0.25 to 4	6
40	0371 78	Green ●				
		PNE - Phase/Neutral/Earth				
		3 connections on 3 levels - metal base Green/yellow marking for the lower level Screwless fixing on rail				
50	0371 52 ⁽²⁾	Grey ●	2.5	0.25 to 4	0.25 to 2.5	5



For Starfix ferrules, crimping tools and CAB 3 marking system

see p. 154-161

Viking 3 terminal blocks – screw connection

for copper cable (continued)

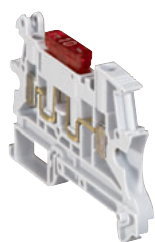

0371 80 + automotive-type fuse

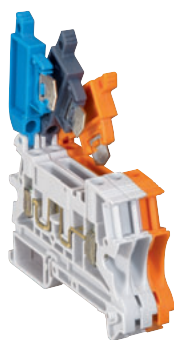

0371 82 + 0371 83 +
0371 85



0371 84 + 0371 86



0371 87

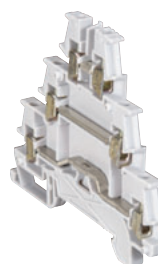

0371 51



0371 52

Accessories (p. 140-141)
Technical characteristics (p. 142)

All V2 polyamide UL94 960 °C to IEC EN 60695-2-11
Compatible with either rigid (0.25 mm² to 95 mm²) or flexible (0.25 mm² to 70 mm²) copper cables
Facility for 2 bridging combs
Compatible with rails depth 15 mm and rails EN 60715 depth 7.5 mm and 15 mm
Range comprises only 2 block heights (2.5 mm² to 10 mm² and 16 mm² to 70 mm²) ensuring a neat installation

Pack	Cat. Nos.	Disconnection				
		1 connection				
		Disconnection by means of blade type lever, handle lever or mini lever (with tool)				
		Open (to be equipped)				
		Can take a blade-type automotive fuse or a miniature circuit breaker				
		Colour	Nominal cross section (mm ²)	Capacity		Width (mm)
				Rigid cable (mm ²)	Flexible cable (mm ²)	
20	0371 80	Grey ●	2.5	0.25 to 2.5	0.25 to 2.5	6
		For fuse cartridge 5 x 20 with handle lever				
20	0371 81	Grey ●	2.5	0.25 to 2.5	0.25 to 2.5	6
		For neutral circuit with blue handle lever				
20	0371 82	Grey/blue ●	2.5	0.25 to 2.5	0.25 to 2.5	6
		For standard circuit with handle lever				
20	0371 83	Grey ●	2.5	0.25 to 2.5	0.25 to 2.5	6
		For standard circuit with mini lever				
20	0371 84	Grey ●	2.5	0.25 to 2.5	0.25 to 2.5	6
		For circuit not broken with handle lever				
		Circuit not broken by the master isolating device				
20	0371 85	Orange ●	2.5	0.25 to 2.5	0.25 to 2.5	6
		For circuit not broken with mini lever				
		Circuit not broken by the master isolating device				
20	0371 86	Orange ●	2.5	0.25 to 2.5	0.25 to 2.5	6
		For cartridge 5 x 20 with screwed plug				
20	0371 87	Grey ●	10	0.25 to 16	0.25 to 10	12

Blown fuse indicators (p. 141)

Pack	Cat. Nos.	Blocks for sensors and actuators				
		For connecting sensors (Cat. No. 0371 51) or actuators (Cat. No. 0371 52), and their shared power supply unit when using equipotential bridging comb				
		Cat. Nos. 0375 46/47 (wiring diagram p. 143)				
		3 connections on 3 levels - for sensor				
		Colour	Nominal cross section (mm ²)	Capacity		Width (mm)
				Rigid cable (mm ²)	Flexible cable (mm ²)	
50	0371 51 ⁽¹⁾	Grey ●	2.5	0.25 to 4	0.25 to 2.5	5
		3 connections on 3 levels - for actuator				
		Green/yellow marking for the lower level				
		Metal base. Screwless fixing on rail				
50	0371 52 ⁽¹⁾	Grey ●	2.5	0.25 to 4	0.25 to 2.5	5

Accessories (p. 140-141)

End stops (p. 140)



For Starfix ferrules, crimping tools and CAB 3 marking system

see p. 154-161

(1) Rigid cable capacity : 2.5 mm² max. only when used with bridging comb

Viking 3 terminal blocks – spring connection for copper cable



See p. 138-139 for product detail

TERMINAL TYPE

0372 60 0372 61 0372 64 0372 40 0372 69 0372 68 0372 02 0372 47 0372 21 0372 42	<p>Connection (p. 138)</p>	<p>1 connection - 1 entry/1 exit</p> <p>1 connection - 1 entry/2 exits</p> <p>1 connection - 2 entries/2 exits</p> <p>2 connections - 2 levels</p>		
0372 70 0372 71 0372 72 0372 12	<p>Protection (p. 138)</p>	<p>1 connection - 1 entry/1 exit - metal base</p> <p>1 connection - 1 entry/2 exits - metal base</p> <p>1 connection - 2 entries/2 exits - metal base</p>		
0372 80 0372 82 0372 83 0372 84	<p>Disconnection (p. 139)</p>	<p>1 connection</p> <p>Open (to be equipped)</p> <p>For fuse cartridge 5 x 20 with handle lever</p> <p>For fuse cartridge 5 x 20 with handle lever + blown fuse indicator</p> <p>For neutral circuit with handle lever</p> <p>For standard circuit</p> <p>For circuit not broken</p>		
0372 54	<p>Function blocks (p. 139)</p>	<p>1 connection - 2 entries/2 exits</p> <p>Diode carrier 1N4007</p> <p>2 connections - 2 entries</p> <p>Diode carrier 1N4007</p> <p>With voltage presence LED</p>		

(1) Blown fuse indicator 12/24/48V_~ Cat. No. 0375 24 or 110/250V_~ Cat. No. 0375 25 (p. 141)
 (2) Lower level only
 (3) Upper level only

accessories for Viking 3 terminal blocks - spring connection

TERMINAL BLOCK				INSULATION		BRIDGING COMBS			MEASUREMENT	ASSOCIATED PRODUCTS							
Nominal cross section (mm ²)	Width (mm)	Colour	Cat. Nos.	End cap	Separation and insulation divider	Comb for 2 blocks	Comb for 3 blocks	Comb for 10 blocks	Test meter adaptor								
4	5		0372 60	0375 86	0375 95	0375 02	-	0375 01	0375 27								
			0372 00														
			0372 20														
	6		0372 61								built-in	0375 95	0375 05	-	0375 04	0375 27	
			0372 01														
			0372 21														
6	8		0372 62	built-in	-	-	0375 07	-	0375 27								
			0372 02														
10	10		0372 63	built-in	-	0375 82	-	-	-								
			0372 03														
16	12		0372 64	built-in	-	0375 85	-	-	-								
			0372 04														
4	5		0372 40	0375 87	0375 95	0375 02	-	0375 01	0375 27								
			0372 41														
			0372 42														
4	6		0372 43	built-in	0375 95	0375 05	-	0375 04	0375 27								
			0372 44														
			0372 45														
4	5		0372 46	0375 88	0375 95	0375 02	-	0375 01	0375 27								
			0372 47														
4	6		0372 69	built-in	-	0375 05	-	0375 04	0375 27								
			0372 09														
4	5		0372 67	0375 89	0375 96	0375 02	-	0375 01	0375 27 ⁽³⁾								
			0372 07														
4	6		0372 68	built-in	0375 96	0375 05	-	0375 04	0375 27 ⁽³⁾								
			0372 08														
4	5		0372 70	0375 86	-	-	-	-	-								
			0372 71														
			0372 72														
			0372 73														
			0372 74														
4	5		0372 10	0375 87	-	-	-	-	-								
			0372 11														
			0372 12														
			0372 13														
4	6		0372 79	built-in	-	-	-	-	-								
			0372 80														
2-5	6		0372 81	0375 90	-	0375 05	-	0375 04	-								
			0372 81														
			0372 81 + 0375 24/25 ⁽¹⁾														
			0372 82														
			0372 83														
			0372 84														
			0372 85														
			0372 86														
4	5		0372 54	0375 88	0375 95	0375 02	-	0375 01	-								
			0372 55														
			0372 56														
4	5		0375 89	0375 89	0375 96	0375 02	-	0375 01	-								
			0375 89														
4	5		0375 89	0375 89	0375 96	0375 02 ⁽²⁾	-	0375 01 ⁽²⁾	-								
			0375 89														

Viking 3 terminal blocks – spring connection for copper cable

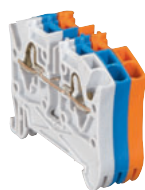

0372 60 + 0372 00 + 0372 20



0372 01



0372 21



0372 63



0372 40

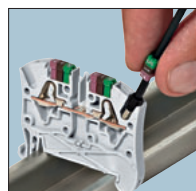

Automatic insertion of stripped cable with ferrule cap or rigid cable up to width of 6 mm

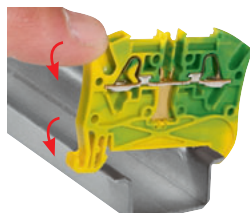

0372 70
Automatic fixing on rail



0372 72



0372 79

Accessories (p. 140-141)
Technical characteristics (p. 144-145)

Screwless connection system, stainless steel spring type
Compatible with either 2 rigid copper cables or flexible cables (0.5 mm² - 16 mm²) with or without ferrules (p. 160)
Direct tool-free insertion of a rigid cable. Direct tool-free insertion of a flexible cable with ferrule, up to 6 mm width
Facility for 2 bridging combs
Compatible with rails EN 60715 depth 7.5 mm and 15 mm

Pack	Cat. Nos.	Connection					
		Grey for standard circuit Blue for neutral conductor Orange for circuit not broken by the master isolating device					
		1 connection - 2 cables - 1 entry/1 exit					
		Colour	Nominal cross section (mm ²)	Rigid cable (mm ²)	Capacity Flexible cable (mm ²)	Flexible cable with ferrule (mm ²)	Width (mm)
60	0372 60	Grey ●	4	0.5 to 6	0.5 to 4	0.5 to 2.5	5
60	0372 00	Blue ●					
60	0372 20	Orange ●					
50	0372 61 ⁽¹⁾	Grey ●	4	0.5 to 6	0.5 to 4	0.5 to 4	6
50	0372 01 ⁽¹⁾	Blue ●					
50	0372 21 ⁽¹⁾	Orange ●					
50	0372 62 ⁽¹⁾	Grey ●	6	0.5 to 6	0.5 to 6	0.5 to 6	8
50	0372 02 ⁽¹⁾	Blue ●					
40	0372 63 ⁽¹⁾	Grey ●	10	0.75 to 10	0.75 to 10	0.75 to 10	10
40	0372 03 ⁽¹⁾	Blue ●					
10	0372 64 ⁽¹⁾	Grey ●	16	4 to 16	4 to 16	4 to 16	12
10	0372 04 ⁽¹⁾	Blue ●					
		1 connection - 3 cables - 1 entry/2 exits					
60	0372 40	Grey ●	4	0.5 to 6	0.5 to 4	0.5 to 2.5	5
60	0372 41	Blue ●					
60	0372 42	Orange ●					
50	0372 43 ⁽¹⁾	Grey ●	4	0.5 to 6	0.5 to 4	0.5 to 4	6
50	0372 44 ⁽¹⁾	Blue ●					
		1 connection - 4 cables - 2 entries/2 exits					
60	0372 46	Grey ●	4	0.5 to 6	0.5 to 4	0.5 to 2.5	5
60	0372 47	Blue ●					
50	0372 69 ⁽¹⁾	Grey ●	4	0.5 to 6	0.5 to 4	0.5 to 4	6
50	0372 09 ⁽¹⁾	Blue ●					
		2 connections - 4 cables - 2 levels					
60	0372 67	Grey ●	4	0.5 to 6	0.5 to 4	0.5 to 2.5	5
60	0372 07	Blue ●					
50	0372 68 ⁽¹⁾	Grey ●	4	0.5 to 6	0.5 to 4	0.5 to 4	6
50	0372 08 ⁽¹⁾	Blue ●					

(1) Built-in end cap

Pack	Cat. Nos.	Protection					
		Metal base Screwless fixing on rail PEN from 10 mm ²					
		1 connection - 2 cables - 1 entry/1 exit					
		Colour	Nominal cross section (mm ²)	Rigid cable (mm ²)	Capacity Flexible cable (mm ²)	Flexible cable with ferrule (mm ²)	Width (mm)
60	0372 70	Green/yellow ●	4	0.5 to 6	0.5 to 4	0.5 to 2.5	5
50	0372 71 ⁽¹⁾	Green/yellow ●					
25	0372 72 ⁽¹⁾	Green/yellow ●	6	0.5 to 6	0.5 to 6	0.5 to 6	8
20	0372 73 ⁽¹⁾	Green/yellow ●					
15	0372 74 ⁽¹⁾	Green/yellow ●	16	4 to 16	4 to 16	4 to 16	12
		Green/yellow ●					
		1 connection - 3 cables - 1 entry/2 exits					
40	0372 10	Green/yellow ●	4	0.5 to 6	0.5 to 4	0.5 to 2.5	5
30	0372 11 ⁽¹⁾	Green/yellow ●					
		1 connection - 4 cables - 2 entries/2 exits					
40	0372 12	Green/yellow ●	4	0.5 to 6	0.5 to 4	0.5 to 2.5	5
30	0372 79 ⁽¹⁾	Green/yellow ●					



For Starfix ferrules, crimping tools and CAB 3 marking system

see p. 154-161

Viking 3 terminal blocks – spring connection for copper cable (continued)

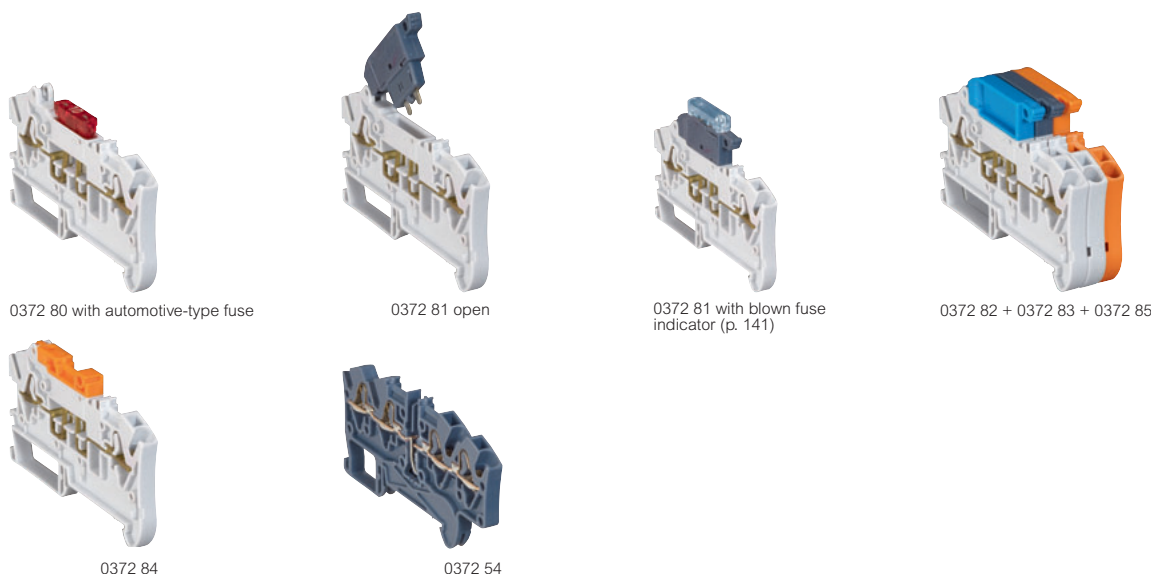

Accessories (p. 140-141)
Technical characteristics (p. 144-145)

Screwless connection system, stainless steel spring type
Compatible with either 2 rigid copper cables or flexible cables (0.5 mm² - 16 mm²) with or without ferrules (p. 160)
Direct tool-free insertion of a rigid cable. Direct tool-free insertion of a flexible cable with ferrule, up to 6 mm width
Facility for 2 bridging combs
Compatible with rails EN 60715 depth 7.5 mm and 15 mm

Pack	Cat. Nos.	Disconnection				
		1 connection - 2 cables				
		Disconnection by means of blade type lever, handle lever or mini lever (with tool)				
		Open (to be equipped)				
		Can take a blade-type automotive fuse or a miniature circuit breaker				
			Capacity			
		Colour	Nominal cross section (mm ²)	Rigid cable (mm ²)	Flexible cable (mm ²)	Flexible cable with ferrule (mm ²)
20	0372 80	Grey ●	2.5	0.5 to 2.5	0.5 to 2.5	0.5 to 2.5
		For fuse cartridge 5 x 20 with handle lever				
20	0372 81	Grey ●	2.5	0.5 to 2.5	0.5 to 2.5	0.5 to 2.5
		For neutral circuit with blue handle lever				
20	0372 82	Grey/blue ●	2.5	0.5 to 2.5	0.5 to 2.5	0.5 to 2.5
		For standard circuit with handle lever				
20	0372 83	Grey ●	2.5	0.5 to 2.5	0.5 to 2.5	0.5 to 2.5
		For standard circuit with mini lever				
20	0372 84	Grey ●	2.5	0.5 to 2.5	0.5 to 2.5	0.5 to 2.5
		For circuit not broken with handle lever				
20	0372 85	Orange ●	2.5	0.5 to 2.5	0.5 to 2.5	0.5 to 2.5
		For circuit not broken with mini lever				
20	0372 86	Orange ●	2.5	0.5 to 2.5	0.5 to 2.5	0.5 to 2.5

Blown fuse indicators (p. 141)

Pack	Cat. Nos.	Function blocks					
		1 connection - 4 cables - 2 entries/2 outlets - diode-carrier					
			Nominal cross section (mm ²)	Rigid cable (mm ²)	Capacity		
		Colour			Flexible cable (mm ²)	Flexible cable with ferrule (mm ²)	Width (mm)
60	0372 54	Grey ●	4	0.5 to 6	0.5 to 4	0.5 to 2.5	5
		2 connections - 4 cables - 2 levels - diode carrier					
60	0372 55	Grey ●	4	0.5 to 6	0.5 to 4	0.5 to 2.5	5
		2 connections - 4 cables - 2 levels - with LED					
		Voltage presence indicator (12/24V= /~)					
60	0372 56	Grey ●	4	0.5 to 6	0.5 to 4	0.5 to 2.5	5

Accessories (p. 140-141)

End stops (p. 140)



For Starfix ferrules, crimping tools and CAB 3 marking system

see p. 154-161

Viking 3 accessories for terminal blocks

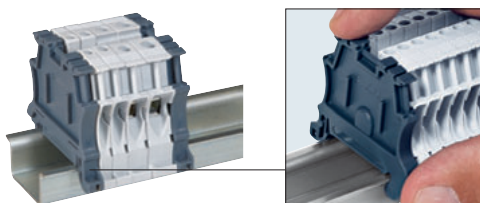

End stop 0375 10, screwless mounting

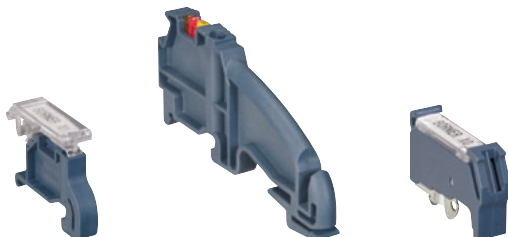

0375 11 with label holder 0395 96

0375 12 with CAB 3 markers

0375 13 with label holder 0395 96

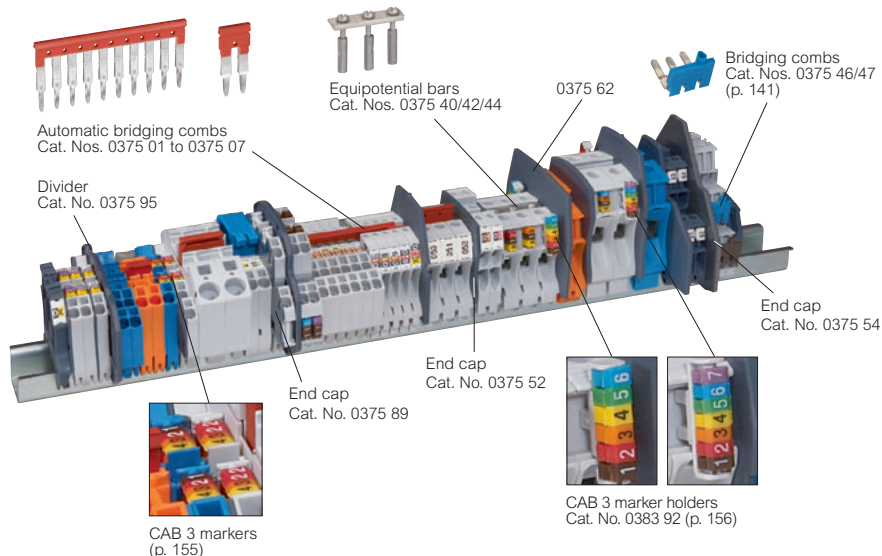

Automatic bridging combs
Cat. Nos. 0375 01 to 0375 07

Equipotential bars
Cat. Nos. 0375 40/42/44

Bridging combs
Cat. Nos. 0375 46/47
(p. 141)

Divider
Cat. No. 0375 95

End cap
Cat. No. 0375 54

End cap
Cat. No. 0375 89

End cap
Cat. No. 0375 52

CAB 3 markers
(p. 155)

CAB 3 marker holders
Cat. No. 0383 92 (p. 156)

Technical characteristics (p. 145)

Pack	Cat. Nos.	Rails
10	0374 04	Length 2 m
10	0374 07	EN 60715 depth 7.5 mm
10	0374 07	depth 15 mm
10	0394 49	45° mounting bracket Set of 2 supports for tilting a rail at an angle of 45° Supplied with 4 x M6 screws, nuts and washers
50	0375 10	End stops Grey Compatible with CAB 3 marking system 6 mm width Screwless mounting For rails EN 60715 depth 15 mm and EN 60715 depth 7.5 mm and 15 mm Accepts label holder Cat. No. 0395 96 Acts as end cap for screw terminal blocks 1 entry/1 exit 5, 6, 8 and 10 mm width
20	0375 11	8 mm width For rails EN 60715 depth 15 mm and EN 60715 depth 7.5 mm and 15 mm Accepts label holder Cat. No. 0395 96
10	0375 12	10 mm width For rails EN 60715 depth 15 mm and EN 60715 depth 7.5 mm (except for rail fixed on plate) and 15 mm - IP 2X terminal block with flat steel bar 12 x 2 mm Cat. No. 0048 19 (p. 42) - Copper bar 12 x 4 mm Cat. No. 0373 89 (p. 45) - Shielding bar 10 x 3 mm Cat. No. 0375 34 (p. 141)
20	0375 13	12 mm width For rails EN 60715, EN 60715 depth 15 mm and EN 60715 depth 7.5 mm and 15 mm
20	0395 96	Identification accessories Transparent label holder With variable angle Fixing on end stops Cat. Nos. 0375 10/11 Supplied with label 32 x 9.5 mm Compatible with label Cat. No. 0395 97
20	0395 97	Label For engraving 28 x 9.5 mm For label holder Cat. No. 0395 96. Flexible ABS White background, black engraving
10	0395 98	Black felt tip pen For permanent marking

CAB 3® marking system (p. 154-156)

Pack	Cat. Nos.	End caps
100	0375 50	Grey
20	0375 51	For screw terminal blocks 1 entry/1 exit 5, 6, 8 and 10 mm width
20	0375 52	1 entry/1 exit 12 and 15 mm width
20	0375 53	2 entries/2 exits
20	0375 54	2 levels
20	0375 54	3 levels
20	0375 55	Disconnection terminal 6 mm width and function blocks 5 mm width
20	0375 56	Disconnection terminal fuse cartridge 5 x 20 with screwed plug
10	0375 57	Disconnection for measurement
50	0375 86	For spring terminal blocks with 5 mm width 5 mm pitch block becomes 6 mm pitch with end cap fitted Permits termination of a 4 mm ² cable complete with ferrule
50	0375 87	1 entry/1 exit
20	0375 88	1 entry/2 exits
20	0375 88	2 entries/2 exits
20	0375 89	2 levels
20	0375 90	For spring terminal blocks with 6 mm width Disconnection type
20	0375 60	Separation and insulation dividers Grey For screw terminal blocks 1 entry/1 exit 5, 6, 8 and 10 mm width
10	0375 61	1 entry/1 exit 12 and 15 mm width
10	0375 62	2 entry/2 exits and disconnection 6 mm width blocks
10	0375 63	2 levels
10	0375 95	For spring terminal blocks 1 entry/1 exit, 1 entry/2 exits and 2 entry/2 exits 5 and 6 mm width
10	0375 96	2 levels
20	0375 01 ⁽¹⁾	Bridging accessories Bridging combs for screw and spring terminal blocks Front mounting (automatic insertion), screwless Isolated and separable. Consecutive or alternating connection. Red
50	0375 02 ⁽¹⁾	For 10 blocks with 5 mm width
20	0375 04 ⁽¹⁾	For 2 blocks with 5 mm width
50	0375 05 ⁽¹⁾	For 10 blocks with 6 mm width
50	0375 05 ⁽¹⁾	For 2 blocks with 6 mm width
20	0375 07 ⁽¹⁾	For 3 blocks with 6 mm width

(1) Blocks Cat. Nos. 0371 51/52 : upper level only
Block Cat. No. 0372 56 : lower level only

Viking 3 accessories for terminal blocks (continued)

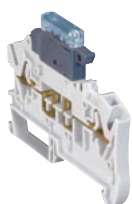

0372 81 + 0375 24



0371 63 + 0371 03 + 0375 66

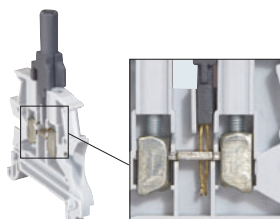

0371 61 + 0375 27

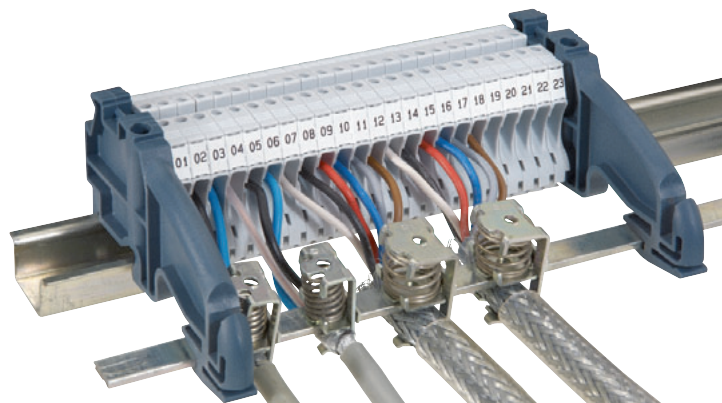

Shielding terminal block with end stops Cat. No. 0375 12 (p. 140), shielding bar Cat. No. 0375 34 and clamps Cat. Nos. 0375 30/31

Technical characteristics (p. 145)

Pack	Cat. Nos.	Bridging accessories (continued)
		Bars for screw terminal blocks Front mounting with screws. Pre-assembled Consecutive or alternating connection
10	0375 40	For 12 blocks with 10 mm width
10	0375 42 ⁽¹⁾	For 12 blocks with 12 mm width
10	0375 44	For 12 blocks with 15 mm width
		Bridging combs for 3-level screw terminal blocks For lower and intermediate levels of blocks Cat. Nos. 0371 51/52. Side mounting Isolated and separable
10	0375 46	Brown. For 12 blocks with 5 mm width
10	0375 47	Blue. For 12 blocks with 5 mm width
		Bridging combs for spring terminal blocks Front mounting (automatic insertion), screwless Isolated. Red
20	0375 82	For 2 blocks with 10 mm width
20	0375 85	For 2 blocks with 12 mm width

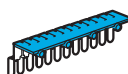

Pack	Cat. Nos.	Accessories for disconnection blocks
		For screw and spring terminal blocks
		Blown fuse indicators Clip directly on to blocks Cat. Nos. 0371 81 or 0372 81
50	0375 24	12/24/48 V _~ / \sim for block with fuse cartridge 5 x 20 with handle lever
50	0375 25	110/250 V _~ for block with fuse cartridge 5 x 20 with handle lever

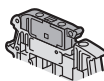

Pack	Cat. Nos.	Shielding accessories
		Ensure safe, simple connection of cable shielding
		Shielding clamps For screw and spring terminal blocks - mounted by pivoting on collector bar 10 x 3 mm Cat. No. 0375 34 - mounted on plate with M4 screws (supplied) - mounted on rail with Cat. No. 0364 69 (p. 26)
10	0375 30	For cable diameter 3 to 8 mm
10	0375 31	For cable diameter 4 to 13.5 mm
4	0375 32	For cable diameter 10 to 20 mm
		Shielding bar For screw and spring terminal blocks. Steel. Length 1 m. For use with end stop Cat. No. 0375 12 (p. 140) 10 x 3 mm
10	0375 34	
50	0375 35	Screening continuity bracket For screw terminal blocks 1 entry/1 exit 5, 6, 8 and 10 mm width Connected with 2.8 x 0.8 mm clips or welded on. Capacity: 1 mm ²

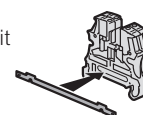

Pack	Cat. Nos.	Protective screens
		1 pole For screw terminal blocks 1 entry/1 exit
10	0375 65	5 and 6 mm width
10	0375 66	8 and 10 mm width
10	0375 67	12 and 15 mm width
		Cut to length Length 1 m Mounted on separation and insulation divider For screw terminal blocks 1 entry/1 exit
10	0375 68	5, 6, 8 and 10 mm width (divider Cat. No. 0375 60, p. 140)
10	0375 69	12 and 15 mm width (divider Cat. No. 0375 61, p. 140)

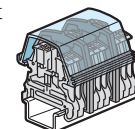
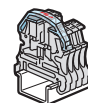

Pack	Cat. Nos.	Test meter adaptor
10	0375 27 ⁽²⁾	For screw and spring terminal blocks Measurement socket for \varnothing 4 mm plug for blocks with 5 and 6 mm width



(1) Except for Cat. No. 0371 87
(2) Except for disconnection blocks with handle lever, screw terminal block with LED and spring function blocks. 2 and 3-level terminal blocks : upper level only

Viking 3 terminal blocks – screw connection

Characteristics and dimensions (mm)

V2 polyamide according to UL 94, 960 °C according to IEC EN 60695-2-11

Connection blocks

Cat. Nos.	Voltage (V)			Current (A)				Nominal cross section		
	IEC	CSA	UL	le	IEC	CSA	UL	IEC (mm ²)	CSA (AWG)	UL (AWG)
0371 00/20/30/60	800	600	600	27	24	20	20	2.5	12	12
0371 01/21/31/61				36	32	30	30	4	10	10
0371 02/62				48	41	50	50	6	8	8
0371 03/63				63	57	60	60	10	6	6
0371 04/64				85	76	85	85	16	4	4
0371 05/65				138	125	115	115	35	2	2
0371 07/67	500	300	300	27	24	20	20	2.5	12	12
0371 08/68				36	32	30	30	4	10	10
0371 09/69				36	32	30	30	4	10	10
0371 66	1000	600	600	213	192	200	200	70	000	000
0371 77	800	600	600	36	32	30	30	4	10	10
0371 78				48	41	50	50	6	8	8

Cat. No. 0371 51 : see blocks for sensors
IEC 60947-7-1, CSA no. 22-2 no. 158, UL 1059
le: Rated current NF C 15100 table 52H, column 4

Cat. Nos. 0371 00/01/
02/03/20/21/30/31/60/
61/62/63/77/78

Cat. Nos.
0371 04/05/64/65

Cat. No. 0371 66

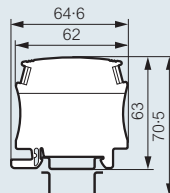
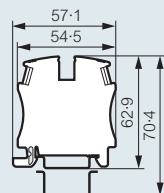
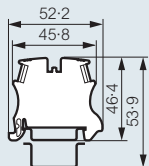

Cat. Nos. 0371 09/69

Cat. Nos. 0371 07/08/67/68

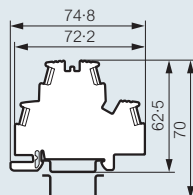
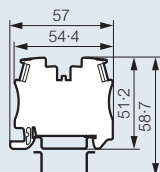

Approved by ATEX :
LCIE 07 ATEX 0010 U-0081 II 1 or 2 G or D Ex e/i/tD/iD II

The terminal blocks with screw connection covered by this certificate are 1-, 2- and 3-level connection terminal blocks, and protection blocks with metal⁽¹⁾ and plastic base (detailed list on p. 132)

The main characteristics are :
Operating temperature : -30 °C to +55 °C
Maximum temperature of materials : +85 °C

Working voltage acc. to EN 60079-7 : 1-level terminal blocks : 500 V
Blocks with 2 entries - 2 exits : 250 V
2 and 3-level terminal blocks : 250 V

Rated current:

Conductor cross section (mm ²)	2.5	4	6	10	16	35	70
Rated current (A)	18	23	30	42	57	93	144

Certificate of conformity of components is available on request

(1) Except for Cat. No. 0371 76

Protection blocks

Cat. Nos.	Voltage (V)			Nominal cross section		
	IEC	CSA	UL	IEC (mm ²)	CSA (AWG)	UL (AWG)
0371 70	800	600	600	2.5	12	12
0371 71				4	10	10
0371 72				6	8	8
0371 73 ⁽¹⁾				10	6	6
0371 74 ⁽¹⁾				16	4	4
0371 75 ⁽¹⁾				35	2	2
0371 76	-	-	-	35	-	-
0371 77	800	600	600	4	10	10
0371 78				6	8	8
0371 79				4	10	10

IEC 60947-7-1/7-2, CSA no. 22-2 no. 158, UL 1059

(1) PEN terminal blocks

Cat. Nos.

0371 70/71/72/73

Cat. Nos. 0371 74/75

Cat. No. 0371 76

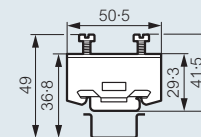
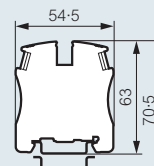
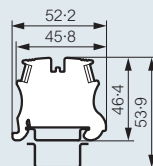

Cat. Nos. 0371 77/78

Cat. No. 0371 79

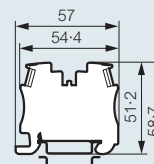
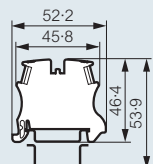

Disconnection blocks

Cat. Nos.	Voltage (V)			Current (A)			Nominal cross section		
	IEC	CSA	UL	IEC	CSA	UL	IEC (mm ²)	CSA (AWG)	UL (AWG)
0371 80	500	300	300	15	15	15	2.5	12	12
0371 81 or 0371 80 + 0375 15	250	250	250	6.3	6.3	6.3			
0371 82	500	300	300	15	15	15			
0371 83									
0371 84									
0371 85									
0371 86									
0371 87	250	250	250	10	10	10	10	10	

IEC 60947-7-1/7-3, CSA no. 22-2 no. 158, UL 1059

Power according to EN 60947-7-3

Cat. Nos.	Short-circuit		Short-circuit + overload	
	Separate blocks	Assembled blocks	Separate blocks	Assembled blocks
0371 81 or 0371 80 + 0375 15 ⁽¹⁾	4 W / 6.3 A Pvk = 4.75 W	1.6 W/6.3 A Pvk = 2 W	1.6 W/6.3 A Pv = 1.65 W	-
0371 87	4 W	2.5 W	1.6 W	-
	Pvk = 5 W	Pvk = 2.7 W	Pv = 1.8 W	-

(1) With or without blown fuse indicator Cat. No. 0375 25

Cat. No. 0371 80

Cat. Nos. 0371 81/82/83/85

Cat. Nos. 0371 84/86

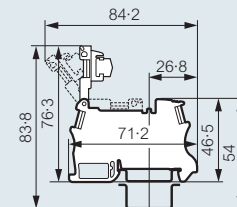
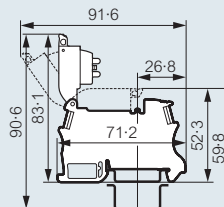
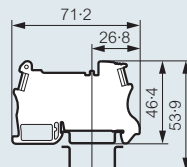

Cat. No. 0371 87

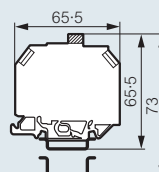

Blocks for sensors and actuators/PNE

Cat. Nos.	Voltage (V)			Current (A)			Nominal cross section			
	IEC	CSA	UL	Ie	IEC	CSA	UL	IEC (mm ²)	CSA (AWG)	UL (AWG)
0371 51 0371 52	400	300	300	27	24	20	20	2.5	12	12

IEC 60947-7-1/7-2, CSA no. 22-2 no. 158, UL 1059
Ie: Rated current NF C 15100 table 52H, column 4

Cat. Nos. 0371 51/52

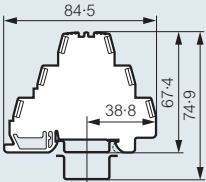

Wiring diagram

Block for sensor Cat. No. 0371 51

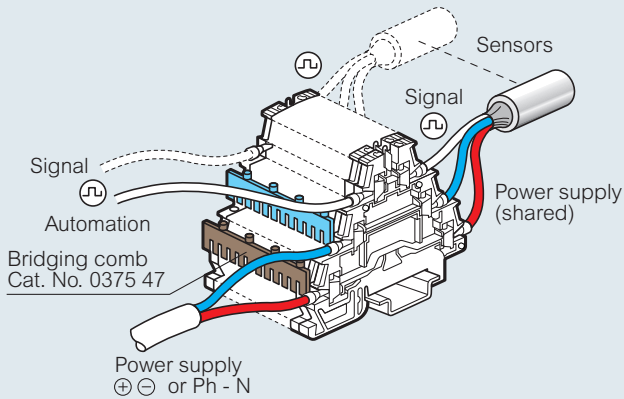

Block for actuator Cat. No. 0371 52

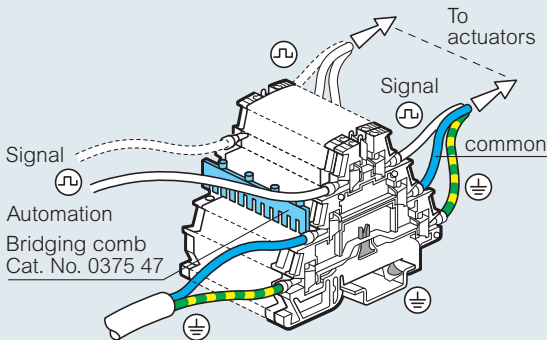

PNE block Cat. No. 0371 52

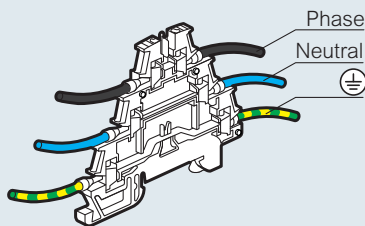

Stripped lengths (mm)

Screw terminal width (mm)	Rigid or flexible cable
5	6 to 8
6	
8	10 to 12
10	
12	13 to 17
15	14 to 18
22	15 to 22

Protection against fire and panic risks in public buildings/UTE C 12-201 guide

Art. EL 3, definitions : "Security installations are those that have to be put into or maintained in service to ensure the evacuation of the public" or facilitate the intervention of the first-aid

Art. EL 16, power supply circuits in security installations section 1a: "...the corresponding junction or deviation devices and their enclosures except for the waterproofing systems must satisfy the incandescent cable test defined in the standard in force, the temperature of the incandescent cable being 960 °C"
Viking 3 terminal blocks satisfy the incandescent cable test 960 °C according to standard IEC 60695-2-11

Viking 3 terminal blocks – spring connection

Characteristics and dimensions (mm)

V2 polyamide according to UL 94, 960 °C according to IEC EN 60695-2-11

Connection blocks

Cat. Nos.	Voltage (V)			Current (A)				Nominal cross section		
	IEC	CSA	UL	le	IEC	CSA	UL	IEC (mm ²)	CSA (AWG)	UL (AWG)
0372 00	800	600	600	36	32	20	20	4	12	12
0372 01				48	41	30	30	6	10	10
0372 02				63	57	50	50	10	8	8
0372 03				85	76	65	65	16	6	6
0372 04										
0372 07	800	600	600	36	32	20	20	4	12	12
0372 08										
0372 09										
0372 20										
0372 21										
0372 40										
0372 41										
0372 42										
0372 43										
0372 44										
0372 46										
0372 47										
0372 60										
0372 61										
0372 62										
0372 63	63	57	50	50	10	8	8			
0372 64	85	76	65	65	16	6	6			
0372 67	500	300	300	36	32	30	30	4	10	10
0372 68										
0372 69										
	800	600	600			20	20		12	12

IEC 60947-7-1, CSA no. 22-2 no. 158, UL 1059
le: Rated current NF C 15100 table 52H, column 4

Protection blocks

Cat. Nos.	Voltage (V)			Nominal cross section		
	IEC	CSA	UL	IEC (mm ²)	CSA (AWG)	UL (AWG)
0372 10	800	600	600	4	10	10
0372 11						
0372 12						
0372 70						
0372 71						
0372 72						
0372 73 ⁽¹⁾						
0372 74 ⁽¹⁾						
0372 79						

IEC 60947-7-2, CSA no. 22-2 no. 158, UL 1059
(1) PEN terminal blocks

Function blocks

Cat. Nos.	Voltage (V)			Current (A)			Nominal cross section		
	IEC	CSA	UL	IEC	CSA	UL	IEC (mm ²)	CSA (AWG)	UL (AWG)
0372 54	500	300	300	1	1	1	4	14	14
0372 55									
0372 56									

IEC 60947-7-1, CSA no. 22-2 no. 158, UL 1059

Cat. Nos. 0372 00/01/
20/21/60/61/70/71

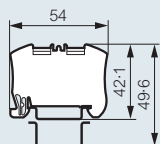

Cat. Nos. 0372 02/62/72

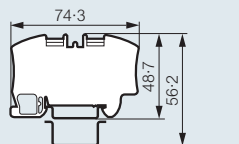
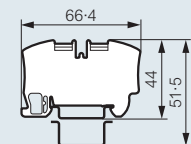

Cat. Nos. 0372 04/
64/74

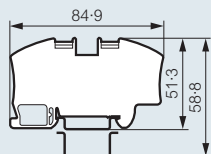

Cat. Nos. 0372 10/11/
40/41/42/43/44

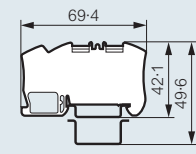

Cat. Nos. 0372 09/12/
46/47/54/69/79

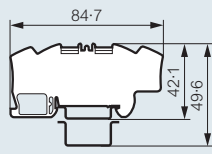

Cat. Nos. 0372 07/08/55/56/67/68

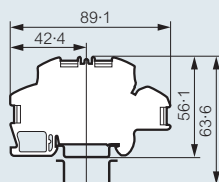

Function block schematic diagrams

Cat. No. 0372 54

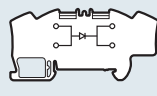

Cat. No. 0372 55

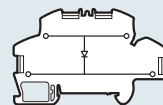

Cat. No. 0372 56

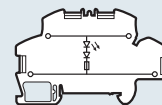

Diode for Cat. Nos. 0372 54/55

- 1N4007 type 1 A
- direct current = 1 A
- peak inverse voltage 1000 V
- inverse current 5 µA at 25 °C

Approved by ATEX :

LCIE 07 ATEX 0010 U-0081 Ex II 1 or 2 G or D Ex e/i/tD/iD II

The terminal blocks with spring connection covered by this certificate are 1- and 2-level connection terminal blocks, and blocks for protection conductor with metal base (detailed list on p. 134)

The main characteristics are :

- Operating temperature : -30 °C to +55 °C
- Maximum temperature of materials : +85 °C

Working voltage acc. to EN 60079-7 : 1-level terminal blocks : 500 V
Blocks with 2 entries - 2 exits : 500 V
2-level terminal blocks : 250 V

Rated current:

Conductor cross section (mm ²)	4	6	10	16
Rated current (A)	23	30	42	57

Certificate of conformity of components is available on request

Disconnection blocks

Cat. Nos.	Voltage (V)			Current (A)			Nominal cross section		
	IEC	CSA	UL	IEC	CSA	UL	IEC (mm ²)	CSA (AWG)	UL (AWG)
0372 80	500	300	300	15	15	15	2.5	14	14
0372 81 or 0372 80 + 0375 15	250	250	250	6.3	6.3	6.3			
0372 82	500	300	300	15	15	15			
0372 83									
0372 84									
0372 85									
0372 86									

IEC 60947-7-1/7-3, CSA no. 22-2 no. 158, UL 1059

Power according to EN 60947-7-3

Cat. Nos.	Short-circuit		Short-circuit + overload	
	Separate blocks	Assembled blocks	Separate blocks	Assembled blocks
0372 81 or 0372 80 + 0375 15 ⁽¹⁾	4 W / 6.3 A	1.6 W / 6.3 A	1.6 W / 6.3 A	-
	Pvk = 4.75 W	Pvk = 2 W	Pv = 1.65 W	-

(1) With or without blown fuse indicator Cat. No. 0375 25

Cat. No. 0372 80

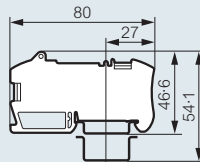

Cat. Nos. 0372 81/82/83/85

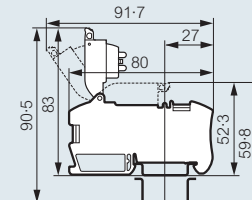

Cat. No. 0372 84/86

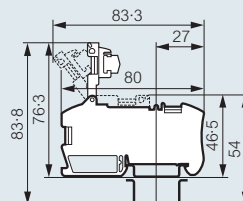

Viking 3 accessories for terminal blocks

Stripped lengths (mm)

Spring terminal width (mm)	Rigid or flexible cable
5	
6	8 to 12
8	
10	8 to 13
12	8 to 15

Protection against fire and panic risks in public buildings/UTE C 12-201 guide

Art. EL 3, definitions : "Security installations are those that have to be put into or maintained in service to ensure the evacuation of the public" or facilitate the intervention of the first-aid

Art. EL 16, power supply circuits in security installations section 1a: "...the corresponding junction or deviation devices and their enclosures except for the waterproofing systems must satisfy the incandescent cable test defined in the standard in force, the temperature of the incandescent cable being 960 °C"

Viking 3 terminal blocks satisfy the incandescent cable test 960 °C according to standard IEC 60695-2-11

■ Characteristics and dimensions (mm)

End stops

Cat. No. 0375 10

Cat. No. 0375 11

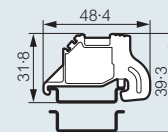
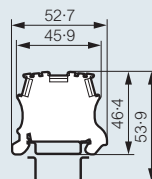

Cat. No. 0375 12

Cat. No. 0375 13

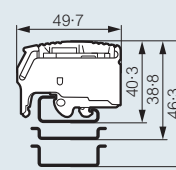
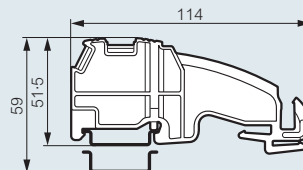

End caps

Cat. Nos.	Thickness (mm)
0375 50	2
0375 51	2.5
0375 52	2
0375 53	2
0375 54	2.5
0375 55	2
0375 56	1.4
0375 57	1.4
0375 86	1
0375 87	1.1
0375 88	1.1
0375 89	1.1
0375 90	2

Separation and insulation dividers

Cat. Nos.	Thickness (mm)
0375 54	2.5
0375 60	2.5
0375 61	2.6
0375 62	2.5
0375 63	2.5
0375 95	2.8
0375 96	2.7

Bridging combs/bars

Cat. Nos.	Cross-section (mm ²)
0375 01	2.5
0375 02	2.5
0375 04	4
0375 05	4
0375 07	6
0375 40	10
0375 42	16
0375 44	35
0375 46	2.5
0375 47	2.5
0375 82	10
0375 85	16

Shielding accessories

Mounting on bar
10 x 3
Cat. No. 0375 34

Mounting on rail
with accessory
Cat. No. 0364 69⁽¹⁾

Mounting on plate

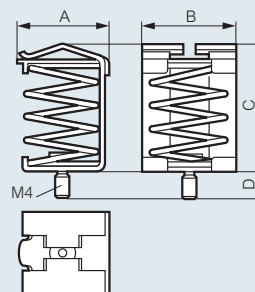
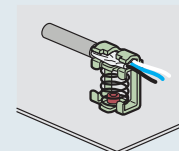
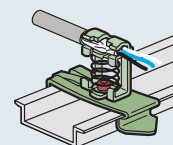
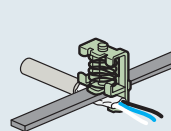

Cat. Nos.	A	B	C	D
0375 30	13.5	18	26	5.6
0375 31	20	20.3	31.4	5.3
0375 32	24.8	26	40	5.3

(1) See enclosures equipment and fixing accessories p. 26

Viking 3 heavy duty terminal blocks

selection chart

	TERMINAL TYPE		TERMINAL BLOCK				INSULATION Separation and insulation divider	BRIDGING COMB Shunt	PROTECTION		 CAB 3 marking system (p. 154)
			Max. connection (mm ²)	Width (mm)	Cat. Nos.				Cover 4 blocks	Cover 3 blocks	
					Rail	Rail					
 0390 11 0390 14 0390 21 Heavy duty terminal blocks (p. 147)	Cable - cable		-	42	0390 10	-	-	0394 46	-	-	
			-	55	0390 11	-	-	0394 47	-	-	
	Cable lug - cable lug		-	36	0390 13	-	-	0394 46	-	-	
			-	42	0390 14	-	-	0394 46	-	-	
			-	55	0390 15	-	-	0394 47	-	-	
			-	42	0390 17	-	-	0394 46	-	-	
	Cable lug - cable		-	42	0390 17	-	-	0394 46	-	-	
			-	55	0390 18	-	-	0394 47	-	-	
Cable - cable lug		-	42	0390 20	-	-	0394 46	-	-		
		-	55	0390 21	-	-	0394 47	-	-		
 0390 32 Heavy duty terminal blocks (p. 148)	For copper bars and cable lugs		-	35	26	0390 71	0390 31	0394 77	-	0394 88	-
			-	70	34	0390 72	0390 32	0394 78	-	0394 86	-
			-	120	34	0390 73	0390 33	0394 78	-	0394 86	-
			-	240	46	0390 74	0390 34	0394 78	-	0394 89	0394 86



For CAB 3 marking system

see p. 154



For enclosures

see p. 14-23

Viking 3 heavy duty terminal blocks

for copper and aluminium cables

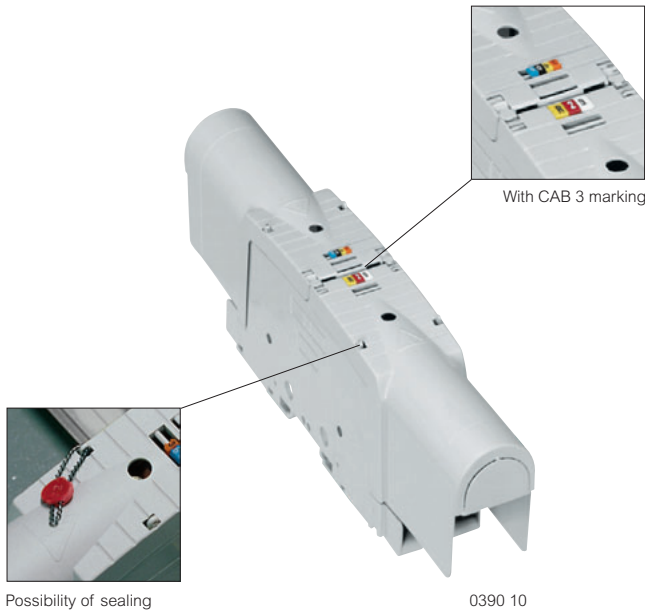

Termination options

Cable - Cable

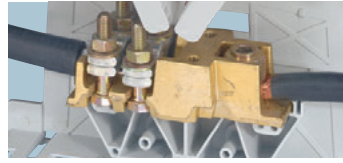

Cable lug - Cable lug

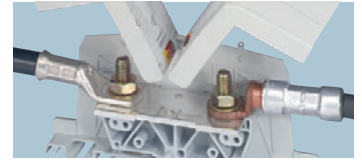

Cable lug - Cable

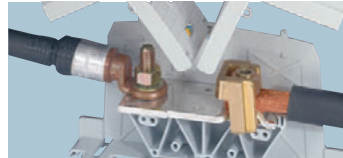

Cable - Cable lug

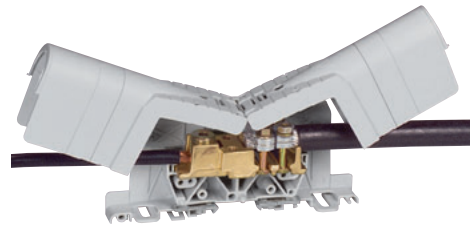
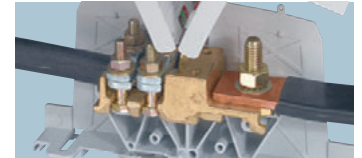

Technical characteristics (p. 149)

Pack	Cat. Nos.	Heavy duty terminal blocks		
		For copper and aluminium cables		
		IK 04 Conform to IEC 60947-7-1, EN 60947-7-1 UL 1059 and 486 E - CSA 22-2 Fire resistant IEC 60695-2-11 : 960°C (except cover) V2 according to UL 94 Bridging the gap between the enclosure and external cables Fixed using metal clip for rails 15 mm depth and EN 60715, 15 mm depth or on plate with screws Fitted with hinged covers with cut-outs Permits the use of CAB 3 markers Test via test plug Ø4 closed covers Blocks with identical width can be joined using a threaded rod Supports shunt with Cat. Nos. 0394 46/47		
5	0390 10	Cable - Cable	Rigid or flexible connecting cable (mm ²)	Width (mm)
5	0390 11		Rigid or flexible cable (mm ²)	
		Cable lug - Cable lug	Connecting plate max. (mm ²)	Width (mm)
5	0390 13		Al/Cu 95	
5	0390 14		Al/Cu 150	
5	0390 15		Al/Cu 300	
		Cable lug - Cable	Connecting plate max. (mm ²)	Width (mm)
5	0390 17		Al/Cu 150	
5	0390 18		Al/Cu 300	

Pack	Cat. Nos.	Accessories
		Shunt
5	0394 46	For blocks with width 36 and 42 mm
5	0394 47	For blocks with width 55 mm

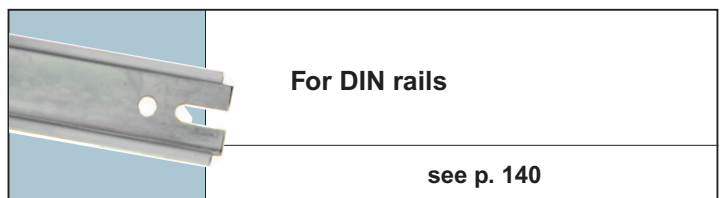

Viking 3 heavy duty terminal blocks

for copper bars and cable lugs

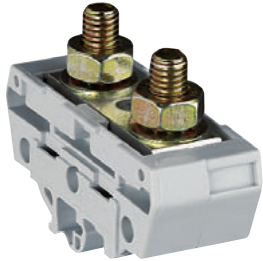

0390 32

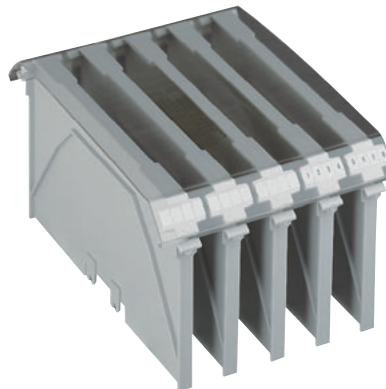

0394 78 + 86

Technical characteristics (p. 149)

Pack	Cat. Nos.	Heavy duty terminal blocks			
		For copper bars or cable lugs			
		Conform to IEC EN 60947-7-1			
		Fire resistance : 960 °C, IEC EN 60695-2-11			
		V2 according to UL94			
		Insulating material : polyamide -30 °C to +100 °C			
		Bridging the gap between the enclosure and external cables			
		Plastic foot			
		For use with terminal marker sheets			
		For symmetrical rails			
		Fixed using metal clip on rails 15 mm depth and EN 60715, 15 mm depth (p. 140)			
		Connecting max. (mm ²)	Width of plate (mm)	Stud (Ø)	Width (mm)
5	0390 71	35	15	M 8	26
5	0390 72	70	20	M 10	34
5	0390 73	120	25	M 10	34
5	0390 74	240	35	M 12	46
		For asymmetrical rails			
		Fixed using metal clip on rails EN 60715 (p. 26)			
5	0390 31	35	15	M 8	26
5	0390 32	70	20	M 10	34
5	0390 33	120	25	M 10 ⁽¹⁾	34
5	0390 34	240	35	M 12 ⁽²⁾	46

Pack	Cat. Nos.	Accessories	
		Separation barriers	
		Take protective covers	
		Marking possible with CAB 3 marking system (p. 154)	
10	0394 77	For terminals with width 26 mm	
10	0394 78	For terminals with width 34 and 46 mm	
		Protective covers	
		For mounting on separation barriers	
5	0394 86	For 3 terminals with width 46 mm or for 4 terminals with width 34 mm	
5	0394 88	For 4 terminals with width 26 mm	
5	0394 89	For 4 terminals with width 46 mm	

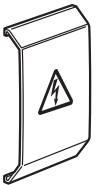

End stops (p. 140)



For CAB 3 marking system

see p. 154



For enclosures

see p. 14-23

Viking 3 heavy duty terminal blocks

■ Characteristics of heavy duty terminal blocks for copper and aluminium cables

IK 04
 Conform to IEC 60947-7-1, EN 60947-7-1
 UL 1059 and 486 E - CSA 22-2
 Fire resistant IEC 60695-2-11 : 960 °C (except cover)
 V2 according to UL 94
 Insulation voltage U_i : 1000 V
 Impulse voltage U_{imp} : 12 kV
 Insulating material :
 - polyamide body -30 °C to +100 °C
 - polypropylene cover -25 °C to +100 °C

Connection table

Cat. Nos.	Connection (mm ²)	Width of plate (mm)	Screw \varnothing	Connection (mm ²)	Width of plate (mm)	Screw \varnothing	Width (mm)
Cable - Cable							
0390 10	Rigid or flexible Cu/Al: 35 to 120	-	-	Rigid or flexible Cu: 35 to 70	-	-	42
0390 11	Rigid or flexible Cu/Al: 70 to 300	-	-	Rigid or flexible Cu: 70 to 150	-	-	55
Cable lug - Cable lug							
0390 13	Cu/Al: max. 95	28	M 8	Cu/Al: max. 95	28	M 8	36
0390 14	Cu/Al: max. 150	34	M 10	Cu/Al: max. 150	34	M 10	42
0390 15	Cu/Al: max. 300	46	M 12	Cu/Al: max. 300	46	M 12	55
Cable lug - Cable							
0390 17	Cu/Al: max. 150	34	M 10	Rigid or flexible Cu: 35 to 95	-	-	42
0390 18	Cu/Al: max. 300	46	M 12	Rigid or flexible Cu: 70 to 150	-	-	55

Cable - Cable



Cable lug - Cable lug



Cable lug - Cable



Cable - Cable lug

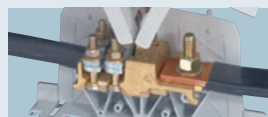

Currents table

Cat. Nos.	Current (A)				Short-circuit current (kA)		Tightening torque (Nm)		Width (mm)
	Shunted input		I/O currents		Shunted input	I/O	Site	Factory	
	IEC	IEC	CSA	UL					
Cable - Cable									
0390 10	340	250	200	170	14.4	8.4	15	15	42
0390 11	570	400	300	285	36	18	35	35	55
Terminal for cable lug - Terminal for cable lug									
0390 13	310	310	250	230	11.4	11.4	15	15	36
0390 14	415	415	340	285	18	18	15	15	42
0390 15	670	670	520	420	36	36	35	35	55
Terminal for cable lug - Cable									
0390 17	415	315	210	230	18	11.4	15	15	42
0390 18	670	420	325	285	36	18	35	35	55
Shunts									
0394 46	450 max.	-	-	-	-	-	6	-	-
0394 47	700 max.	-	-	-	-	-	10	-	-

Cable section equivalence table

mm ²	35	70	95	120	150	185	300
AWG	2	00	0000	250	300	350	600

Dimensions (mm)

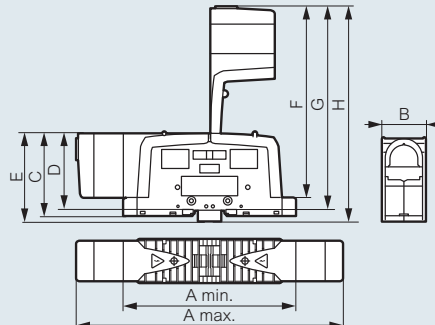

Cat. Nos.	A max.	A min.	B	C	D	E	F	G	H
0390 13	227	155	36	82	73	88	176	185	191
0390 10/14/17	296	200	42	83.5	74.5	89.5	212	221	227
0390 11/15/18	337	216	55	107.3	98.5	113.5	257	266	272

■ Characteristics of heavy duty plate terminal blocks for copper bars or cable lugs

IEC EN 60947-7-1
 Fire resistance :
 960 °C, IEC EN 60695-2-11
 V2 according to UL 94
 Insulating material :
 polyamide -30 °C to +100 °C

Cat. Nos.	Voltage (V) IEC	Intensity (A) IEC
0390 31/71	1000	125
0390 32/72	1000	192
0390 33/73	1000	269
0390 34/74	1000	415

Dimensions (mm)

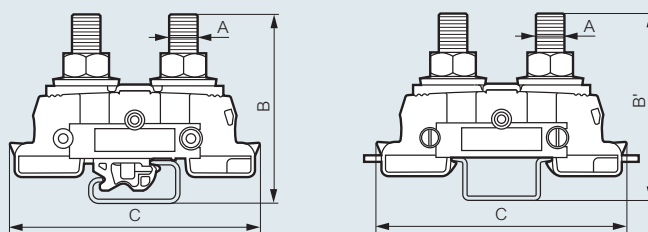

Cat. Nos. 0390 31/32/33/34

Cat. Nos. 0390 71/72/73/74

Cat. Nos.	A	B	B'	C
0390 31	M 8	56		84
0390 32	M 10	61		84
0390 33 ⁽¹⁾	M 10	61		84
0390 34 ⁽²⁾	M 12	64		86
0390 71	M 8		55.3	84
0390 72	M 10		60.4	84
0390 73	M 10		60.4	84
0390 74	M 12		63.5	86

■ Separation barriers

Dimensions (mm)

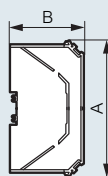

Cat. Nos. 0394 77/78

Cat. Nos.	A	B	Thickness
0394 77	106	82	8
0394 78	188	102	12

(1) Previously M 12 + block length 78.5 mm
 (2) Previously M 16 + block length 94 mm

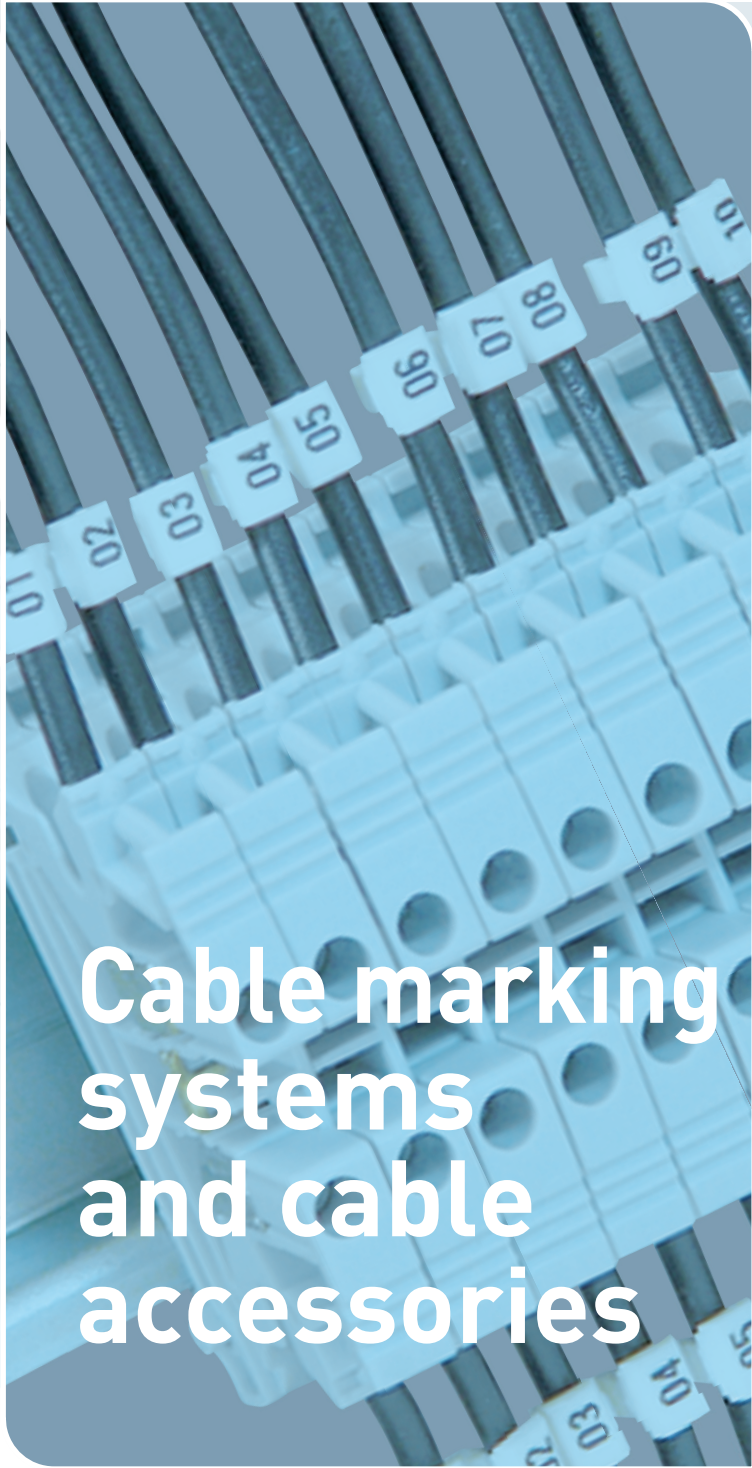

Cable marking systems and cable accessories

Marking systems

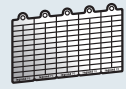

P. 154
Marking label sheets

Cable ties

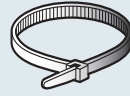

P. 157
Colring cable ties

Starfix®



P. 160
Starfix ferrules



P. 154
CAB 3
marking system



P. 156
CAB 3
marking system
accessories



P. 156
Technical
information



P. 157
Colson
cable ties



P. 158
Colring
cable ties
technical
information



P. 159
Colson
cable ties
technical
information

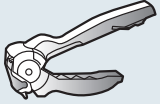

P. 160
Crimping tools
for Starfix
ferrules

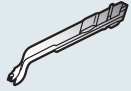

P. 161
Applicators
for Starfix
crimping tools



P. 161
Starfix
technical information

Completing the perfect installation

Create reliable connections which are clearly marked and secured with Legrand's range of cabling accessories. From Starfix tools and ferrules to CAB 3 marking systems and Colson and Colring cable ties, we've got everything you need to complete your installation to the highest standard.

Starfix crimping tools - available in 3 sizes for cables from 0.25 to 6mm²

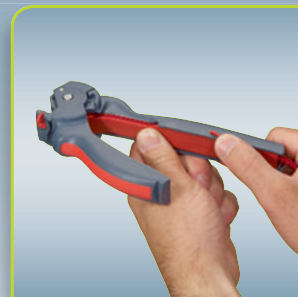

Fit the applicator



Adjust cable size



Insert cable and crimp

Starfix multi-purpose crimping tool - for cables from 0.5mm to 2.5mm²



Adjust cross section

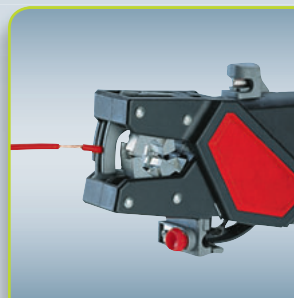

Cut, strip and twist

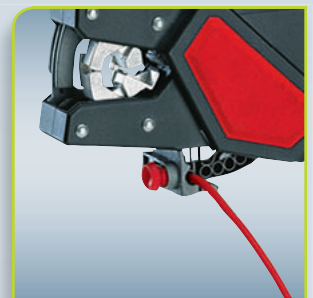

Crimp

Create reliable connections in seconds with Starfix crimping tools and ferrules... everything you need for 0.25 to 50mm² cables.



Crimping tools, applicators and mixed ferrules are available in convenient kits to get you started.

Colring® cable ties

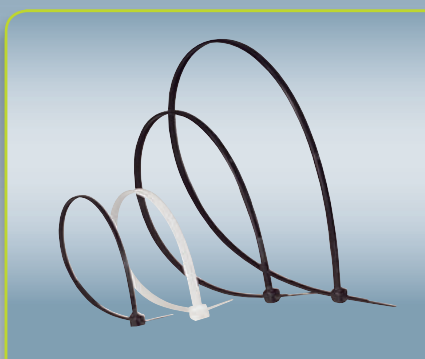

Colring polyamide 6/6 cable ties feature internal teeth and are available in black UV protected and colourless non UV protected options.



Tool available for tightening and trimming of Colring cable ties

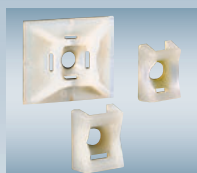

Self-adhesive and screw mounting bases available

Colson® cable ties



Colson polyamide 12 (halogen-free, low fire hazard) cable ties feature external teeth and offer UV, high level acid and chemical protection.



Tool available for tightening and trimming of Colson cable ties



Screw mounting and wall plug bases available

Making your mark

CAB 3 offers a high quality solution to multiple cable and terminal marking requirements. Universal fittings enable clear, rapid marking and simple modification.

- Sizes range from 0.15 to 6mm²
- Numbers, letters and conventional symbols available
- International marker colours
- For Viking 3 terminal blocks, heavy duty terminal blocks - or fit directly onto cables
- Mixed marker sets available

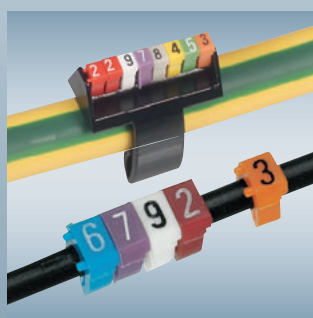

Markers can be fitted directly onto cables or via a marker holder

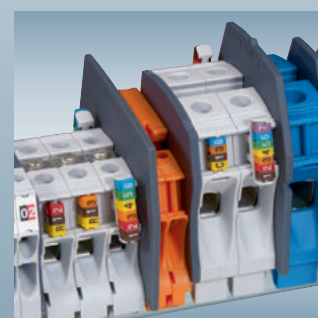

Terminal block installation with CAB 3 markers

marking label sheets for Viking 3 terminal blocks

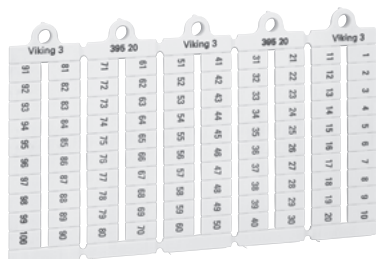

0395 20



0395 98

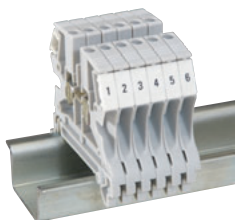

0395 05 on Viking 3 terminal blocks

CAB 3[®] marking system for cables and Viking 3 terminal blocks

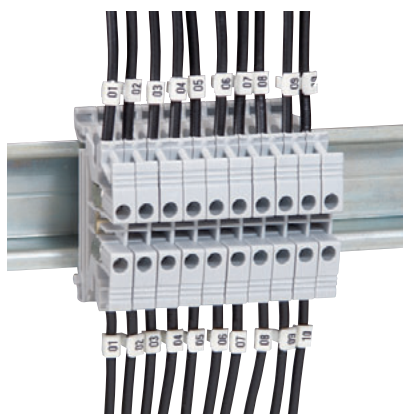

Same markers for cable and terminal blocks

Strips of 20 markers
For cables or Viking 3 terminal blocks

[Technical information \(p. 156\)](#)

Pack	Cat. Nos.	Blank markers
1000	0395 00	Displayed by sheet of 100 pre-cut markers Manual marking with black felt tip pen Cat. No. 0395 98 For blocks 5 mm width
1000	0395 01	For blocks 6 mm width
1000	0395 02	For blocks 8 mm width

Pre-printed markers – numbers

Horizontal format		
Width of 5 mm		
1000	0395 05	From 1 to 10 (10 times)
1000	0395 06	From 11 to 20 (10 times)
1000	0395 09	From 1 to 50 (2 times)
1000	0395 10	From 1 to 100
Width of 6 mm		
1000	0395 15	From 1 to 10 (10 times)
1000	0395 16	From 11 to 20 (10 times)
1000	0395 19	From 1 to 50 (2 times)
1000	0395 20	From 1 to 100
1000	0395 21	From 101 to 200

Black felt tip pen		
10	0395 98	Permanent marker

Pack	Cat. Nos.	Markers for cables 1.5 to 2.5 mm ² cross section and terminal blocks
240	0381 60	01 to 20
240	0381 61	21 to 40
240	0381 62	41 to 60
240	0381 63	61 to 80

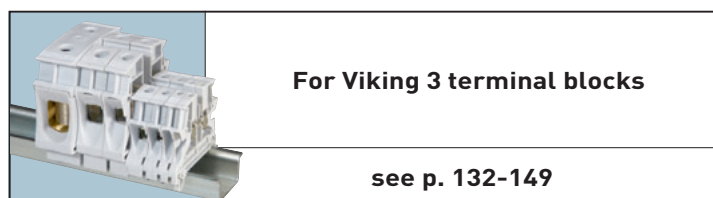

CAB 3[®] marking system for cables and Viking 3 terminal blocks



Perfect alignment of markers



0382 12

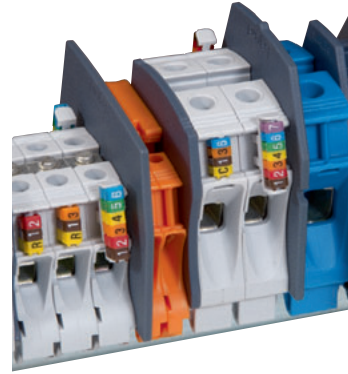

Terminal blocks with CAB 3 markers and label holders

Technical information (p. 156)

Pack ⁽¹⁾	Cat. Nos.		Markers for cables 0.15 to 0.5 mm ² and 0.5 to 1.5 mm ² cross section and terminal blocks	
	0.15 to 0.5 ²	0.5 to 1.5 ²	On Viking 3 terminal blocks - 4 markers 0.15 to 0.5 mm ² max. - 3 markers 0.15 to 1.5 mm ² max.	
			Digits : (international colour code)	
1 000	1 200	0381 00	0382 10	0 Black
1 000	1 200	0381 01	0382 11	1 Brown
1 000	1 200	0381 02	0382 12	2 Red
1 000	1 200	0381 03	0382 13	3 Orange
1 000	1 200	0381 04	0382 14	4 Yellow
1 000	1 200	0381 05	0382 15	5 Green
1 000	1 200	0381 06	0382 16	6 Blue
1 000	1 200	0381 07	0382 17	7 Purple
1 000	1 200	0381 08	0382 18	8 Grey
1 000	1 200	0381 09	0382 19	9 White
			Letters : (black on yellow background)	
300	0381 10	0383 00		A
300	0381 11	0383 01		B
300	0381 12	0383 02		C
300	0381 13	0383 03		D
300	0381 14	0383 04		E
300	0381 15	0383 05		F
300	0381 16	0383 06		G
300	0381 17	0383 07		H
300	0381 18	0383 08		I
300	0381 19	0383 09		J
300	0381 20	0383 10		K
300	0381 21	0383 11		L
300	0381 22	0383 12		M
300	0381 23	0383 13		N
300	0381 24	0383 14		O
300	0381 25	0383 15		P
300	0381 26	0383 16		Q
300	0381 27	0383 17		R
300	0381 28	0383 18		S
300	0381 29	0383 19		T
300	0381 30	0383 20		U
300	0381 31	0383 21		V
300	0381 32	0383 22		W
300	0381 33	0383 23		X
300	0381 34	0383 24		Y
300	0381 35	0383 25		Z
			Conventional symbols : (black on yellow background)	
300	0381 40	0382 70		/
300	0381 41	0382 71		•
300	0381 42	0382 72		+
300	0381 43	0382 73		-
300	0381 44	0382 74		~
300		0382 75		≡
300		0382 76		⊕

Pack ⁽¹⁾	Cat. Nos.		Markers for cables 1.5 to 2.5 mm ² and 4 to 6 mm ² cross section	
	1.5 to 2.5 ²	4 to 6 ²	Digits : (international colour code)	
1 200	800	0382 20	0382 30	0 Black
1 200	800	0382 21	0382 31	1 Brown
1 200	800	0382 22	0382 32	2 Red
1 200	800	0382 23	0382 33	3 Orange
1 200	800	0382 24	0382 34	4 Yellow
1 200	800	0382 25	0382 35	5 Green
1 200	800	0382 26	0382 36	6 Blue
1 200	800	0382 27	0382 37	7 Purple
1 200	800	0382 28	0382 38	8 Grey
1 200	800	0382 29	0382 39	9 White
			Letters : (black on yellow background)	
300	0383 30	0383 60		A
300	0383 31	0383 61		B
300	0383 32	0383 62		C
300	0383 33	0383 63		D
300	0383 34	0383 64		E
300	0383 35	0383 65		F
300	0383 36	0383 66		G
300	0383 37	0383 67		H
300	0383 38	0383 68		I
300	0383 39	0383 69		J
300	0383 40	0383 70		K
300	0383 41	0383 71		L
300	0383 42	0383 72		M
300	0383 43	0383 73		N
300	0383 44	0383 74		O
300	0383 45	0383 75		P
300	0383 46	0383 76		Q
300	0383 47	0383 77		R
300	0383 48	0383 78		S
300	0383 49	0383 79		T
300	0383 50	0383 80		U
300	0383 51	0383 81		V
300	0383 52	0383 82		W
300	0383 53	0383 83		X
300	0383 54	0383 84		Y
300	0383 55	0383 85		Z
			Conventional symbols : (black on yellow background)	
300	0382 80	0382 90		/
300	0382 81	0382 91		•
300	0382 82	0382 92		+
300	0382 83	0382 93		-
300	0382 84	0382 94		~
300	0382 85	0382 95		≡
300	0382 86	0382 96		⊕

(1) Up to 0.5 mm²: strips of 25 markers
From 0.5 mm² to 2.5 mm²: strips of 30 markers
Upper 2.5 mm²: strips of 20 markers

CAB 3[®] marking system accessories



Technical information (opposite)

Pack	Cat. Nos.	CAB 3 accessories
		Marker holders – for cable
		For cables with cross section from 10 mm ² to 70 mm ² Capacity : 8 digit, letter or symbol markers from 0-5 to 1-5 mm ² or 1-5 to 2-5 mm ² cross section Black
100	0384 90	10 to 16 mm ² cable cross section
50	0384 91	25 to 35 mm ² cable cross section
50	0384 92	50 to 70 mm ² cable cross section
		Marker holders – for Viking 3 terminal blocks
100	0383 92	Can be clipped onto Viking 3 terminal blocks Capacity : 7 markers from 0-15 to 0-5 mm ² 6 markers from 0-5 to 1-5 mm ²
		Transparent applicators
		For rapid selection and application of markers onto cable
		For markers cross section (mm ²) Applicator colour for identification of cross section
10	0383 94	0-15 to 0-5 Green
10	0383 95	0-5 to 1-5 Red
10	0383 96	1-5 to 2-5 Blue
10	0383 97	4 to 6 Yellow
		Set of mixed markers
1	0382 01	0-15 to 0-5 mm ² : 2 500 markers + 10 applicators (250 digits from 0 to 9)
1	0382 02	0-5 to 1-5 mm ² : 3 000 markers + 10 applicators (300 digits from 0 to 9)
1	0382 03	1-5 to 2-5 mm ² : 3 000 markers + 10 applicators (300 digits from 0 to 9)
1	0382 04	4 to 6 mm ² : 2 000 markers + 10 applicators (200 digits from 0 to 9)
		On-site toolbox
1	0382 00	With removable tray for CAB 3 markers and applicators, Starfix ferrules etc. Height 85 mm, depth 280 mm, width 450 mm Metal, padlockable Supplied empty

CAB 3[®] marking system for cables and Viking 3 terminal blocks

■ Dimensions

Markers

Polyamide 6/6

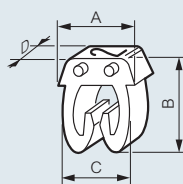

Dimensions	Cable cross section (mm ²)			
	0-15 to 0-5	0-5 to 1-5	1-5 to 2-5	4 to 6
A (mm)	5	5	5-6	8
B (mm)	5-0.5	6-4	7-6	9-6
C (mm)	3-7	4-3	4-9	7-1
D (mm)	2-3	3	3	3
Ø min./max. (mm)	0-8/2-2	2-2/3	2-8/3-8	4-3/5-3

Marker holders – for cable

Cat. No. 0384 90

Cat. No. 0384 91

Cat. No. 0384 92

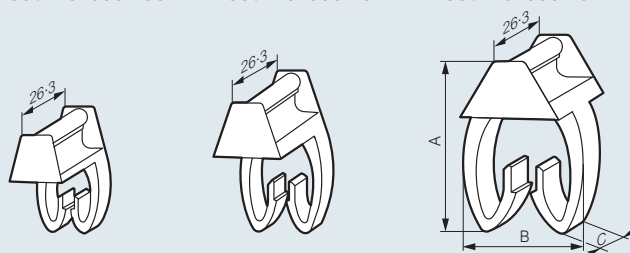

Dim.	Section of cable for marking (mm ²)	25 to 35	50 to 70
A (mm)	18	24-3	27-2
B (mm)	8-9	12-2	17-2
C (mm)	7	7	10

Marker holders – for Viking 3 terminal blocks

Cat. No. 0383 92

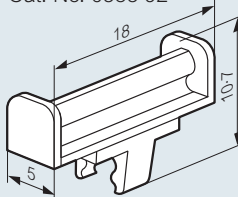

On-site toolbox

Cat. No. 0382 00

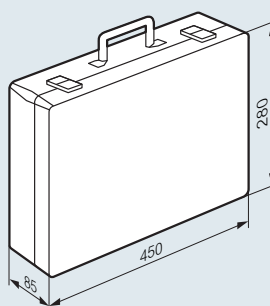

Bottom tray consists of :

- 8 medium slots (each slot takes 1 box of CAB 3)
- 1 large slot

Top tray consists of :

- 12 small slots (<=> approx. 6 boxes of CAB 3)
- 1 medium slot for applicators
- Capacity : approx. 15000 CAB 3 markers

■ Examples

CAB 3 fitted on to Viking 3 terminal blocks using marker holder (Cat. No. 0383 92)



Fitted directly on to heavy duty terminal blocks

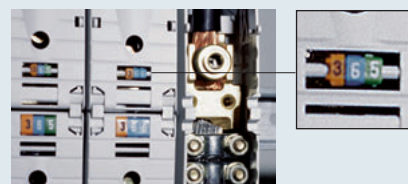

Fitted on to cable with marker holder (Cat. No. 0384 92)



Colring® cable ties



0320 15/37/22/24



0320 42 supplied in blister pack



0320 65



0320 70



0320 72



0320 88

Technical information (p. 158)

Pack Cat. Nos. Colring cable ties with internal teeth

Pack	Cat. Nos.	Polyamide 6/6 colourless				
		Width (mm)	Flat length (mm)	Max. Ø grip capacity (mm)	Min. Ø grip capacity (mm)	Weight (g)
1000	0320 30	2-4	95	18	1-6	0-26
1000	0320 31	2-4	140	33	1-6	0-37
1000	0320 32	2-4	180	46	1-6	0-47
1000	0320 37	3-5	140	33	1-6	0-57
1000	0320 38	3-5	180	46	1-6	0-73
100	0320 39	3-5	280	77	1-6	1-13
100	0320 40	3-5	360	102	1-6	1-46
1000	0320 42	4-6	180	46	1-6	1-20
100	0320 43	4-6	280	77	1-6	1-88
		Polyamide 6/6 black				
		High temperature UV protected Blister packed				
100	0320 12	2-4	95	18	1-6	0-26
100	0320 15	3-5	140	33	1-6	0-57
100	0320 22	4-6	180	46	1-6	1-20
100	0320 24	4-6	360	102	1-6	2-38

Accessories

100	0320 65	Self-adhesive base For ties up to 4-6 mm max. width Colourless
1000	0320 70	Screw mounting bases For ties 4-6 mm max. width Central fixing (screw Ø 4 mm)
100	0320 72	For ties all widths Central fixing (screw Ø 5 mm)
Tool for Colring cable ties Max. width 4-6 mm Direct adjustment of clamping tension by using the milled screw at the base of the handle After clamping, a blade automatically cuts the surplus length close to the head without leaving a burr		
1	0320 88	P 46 tool for cable ties max. width 4-6 mm

Colson® cable ties



0319 16



0319 50



0319 55



0319 96

Technical information (p. 159)

Pack Cat. Nos. Colson UV protected cable ties

Pack	Cat. Nos.	UV protected External teeth Black polyamide 12				
		Width (mm)	Flat length (mm)	Max. Ø grip capacity (mm)	Min. Ø grip capacity (mm)	Weight (g)
100	0319 13	9	185	42	10	3-2
100	0319 16	9	265	62	26	4-7
100	0319 19	9	355	92	26	6-9
100	0319 20	9	500	140	74	12-7
100	0319 21	9	750	220	74	16-9
100	0319 22	6	119	25	4	1-6
100	0319 25	6	180	45	10	2-0

Accessories

100	0319 50	Screw-on base Black For ties max. width 9 mm. Height : 12 mm for cartridge-fired stud and rag-bolt Ø 6-35, metal stud Ø 7 mm and countersunk screws Ø 5 mm
100	0319 55	Wall plug base Black Ø 8 mm drilling
1	0319 96	Tool for Colson cable ties Black and red finish Allows tightening and trimming of Colson ties

■ Performance

Conform to EN 62275 type 1 (NFC 68-146)
 "cable ties for electrical installations"
 Recognised UL 1565 approval

■ Technical data

Good resistance to bases, oils, greases and petroleum products
 Limited resistance to acids, sensitive to mineral acids and no resistance to phenol

Cable ties Polyamide 6/6		Max. ratchet force (daN)	Tensile strength	
Colourless Non UV protected	Black High temperature UV protected		According to EN 50146	
			Test dia. (mm)	Min. guaranteed strength (daN)
0320 30	0320 12	0.50	18	8.0
0320 31		0.50	20	8.0
0320 32		0.50	20	8.0
0320 37	0320 15	0.50	20	13.0
0320 38		0.50	20	13.0
0320 39		0.50	20	13.0
0320 40		0.50	20	13.0
0320 42	0320 22	0.50	20	22.0
0320 43		0.50	20	22.0
	0320 24	0.50	20	22.0

Type	Colring colourless	Colring black
UV protection	no	yes
Polyamide material	6/6	6/6
Teeth	internal	internal
Halogen free ⁽¹⁾	yes	yes
Humidity absorption ⁽²⁾	2.5 %	2.5 %
Operating temperature		
- 20,000 hrs	85 °C	105 °C
- 1,000 hrs	100 °C	120 °C
Resistance to low temperatures		
- fitted	-15 °C	-15 °C
- assembly	-10 °C	0 °C
Flame retardancy	UL 94 V2	UL 94 V2
Oxygen index (LOI) (EN ISO 4589-1/ASTM D 2863-00)	28.5 %	26 %
Self-extinguishing ⁽³⁾	850 °C	850 °C

(1) Conform to Class I ASTM D 4066 (Class 2 for Colring black)
 (2) Conform to ISO 62 (EH 0-23 °C)
 (3) Conform to IEC 60695-2-12

External agents resistance

- Good resistance to bases, oils, greases, petroleum products, chlorinated solvents
- Humidity retention : 1.5 % ≤ humidity retention ≤ 3 %

Fire resistance

- Flame resistance UL 94 : V2
- Flame-retardant
- Self-extinguishing 850 °C according to IEC 60695-2-12
- Oxygen index : EN ISO 4589-1 / ASTM D 2863-00 : 28.5% (26% for Colring black)
- Halogen-free polyamide, class 1 according to ASTM D 4066 (Class 2 for Colring black)

■ Dimensions

Accessories for Colring

Cat. No. 0320 65

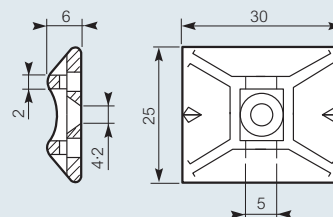

Cat. No. 0320 70

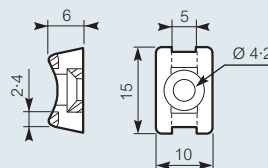

Cat. No. 0320 72

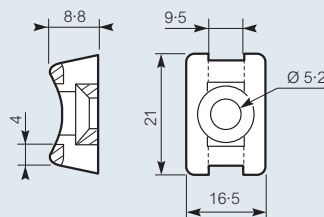

Colson® cable ties

■ Performance

Conform to EN 62275 type 1 (NFC 68-146)
"cable ties for electrical installations"

Test conditions :

- Temperature : 23 °C
- Relative humidity of air : 50 %
- Traction speed : 25.4 mm/min

■ Technical data

Constant high quality

Type tests

- Raw material test
- Product test on the production line and in the laboratory
- Packaging test

Tensile strength (according to EN 50146)

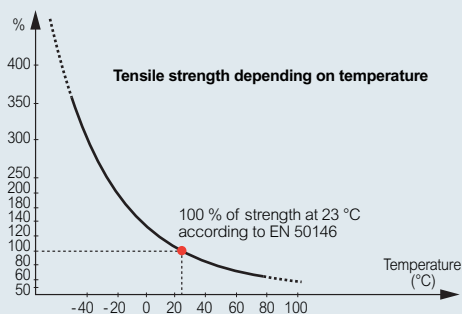

Quality of tensile strength

Cat. Nos.	Diagram (A) - Max. ratchet force (daN)	Diagram (B) - Tensile strength	
		Test dia. (mm) According to EN 50146	Min. strength (daN)
0319 13	4	20	36
0319 16	5	26	53
0319 19	5	26	53
0319 20	5.5	74	53
0319 21	5.5	74	53
0319 22	4	20	22
0319 25	4	20	22

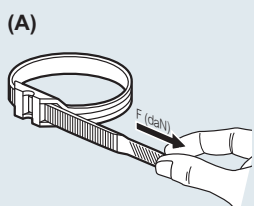

Fire resistance

- Flame retardant
- Conform to UL 94 requirements, HB classification
- Glow-wire flammability resistance according to IEC 60695-2-11 : 650 °C
- Oxygen index (LOI) according to EN ISO 4589-1/ASTM D 2863-00 : 20 %
- Low fire hazard polyamide

UV protected according to norm IEC 62275 type 1

UV protected black cable ties for outdoor use
These black cable ties have successfully undergone UV resistance and climatic ageing tests representing actual conditions of use
These cycles combine a 1000 hours radiance under arc or xenon lamp according to ISO 4892-2 method 1

Resistance to external agents

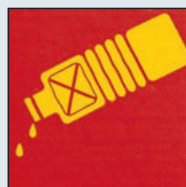

- Good resistance to oils, greases, petroleum products, saline mist and diluted acids

Resistance to rain

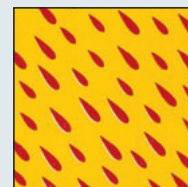

- Humidity absorption: ≤0.7%

Resistance to low temperatures



- Assembly -30 °C
- Fitted -40 °C

Resistance to sun



- Maximum temperatures :
- 85 °C continuous
 - 100 °C @ 1000 hrs
 - UV resistant

Colson approvals

Oxygen index : EN ISO 4589-1 and ASTM D 2863-00, 20 %

Corrosiveness of fumes : NFC 20-453, < 5 %

Flame retardancy : UL 94 HB

Type	Colson black
UV protection	yes
Polyamide material	12
Teeth	external
Halogen free ⁽¹⁾	yes
Humidity absorption ⁽²⁾	<0.7 %
Operating temperature	
- 20,000 hrs	85 °C
- 1,000 hrs	100 °C
Resistance to low temperatures	
- fitted	-40 °C
- assembly	-30 °C
Flame retardancy	UL 94 HB
Oxygen index (LOI) (EN ISO 4589-1/ASTM D 2863-00)	20 %
Self-extinguishing ⁽³⁾	650 °C

(1) Conform to Class I ASTM D 4066

(2) Conform to ISO 62 (EH 0-23 °C)

(3) Conform to IEC 60695-2-11

■ Colson traceability

Each Colson cable tie can be identified, underlining Legrand's commitment to the consumer, so that you can always be sure you are using a genuine Colson

■ Dimensions

Accessories for Colson

Cat. No. 0319 50

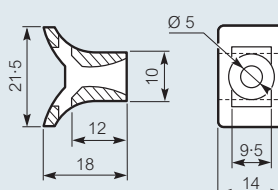

Cat. No. 0319 55

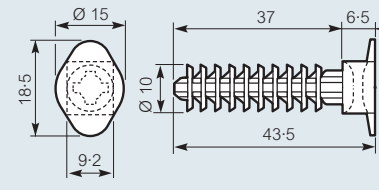

Starfix® ferrules and crimping tools



0376 50



0376 60



0376 61



0376 62



0376 63



0376 87



0376 64



0376 66



0376 67



0376 68



0376 43



0376 09 + refill 0376 43



Adjustable cross section



0376 06



0376 39



0376 92

Technical information (p.161)

Pack	Cat. Nos.	Ferrules with insulating flange			
		Provide an equipotential link for all the strands of a flexible conductor Active part in tinned electrolytic copper Conform to NF C 63-023			
		Single ferrules (in strips) Supplied in strips to prevent loss of ferrules			
		For cables cross section (mm ²)	Colour	Strips	Ferrules
500	0376 50	0-25	turquoise	10	50
500	0376 60	0-34	green	12	40
480	0376 61	0-5	white	12	40
480	0376 62	0-75	blue	12	40
1000	0376 63	1-0	red	25	40
1000	0376 64	1-5	black	25	40
1000	0376 66	2-5	grey	25	40
250	0376 67	4-0	orange	10	25
250	0376 68	6-0	green	10	25
		Individual ferrules - single			
100	0376 69	10	brown		
100	0376 70	16	white		
50	0376 71	25	black		
		Individual ferrules - double			
100	0376 87	2 x 0-75	blue		
100	0376 88	2 x 1-0	red		
100	0376 89	2 x 1-5	black		
100	0376 90	2 x 2-5	grey		
		Large capacity refills Large capacity for less frequent applicator reloading Translucent packaging For direct mounting on crimping tool Cat. No. 0376 09			
		Cross section (mm ²)	Colour	Number of ferrules per strip	
3000	0376 41	0-5	White	300	
3000	0376 42	0-75	Blue	300	
3000	0376 43	1-0	Red	300	
3000	0376 44	1-5	Black	300	
2500	0376 45	2-5	Grey	250	

Colours according to NF C 63-023 standard

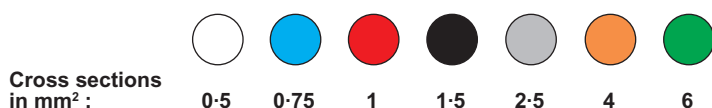

Cross sections in mm² :

0-5 0-75 1 1-5 2-5 4 6

Pack	Cat. Nos.	Crimping tools for ferrules in strips	
		Cut and carry out 4-point crimping of ferrules from 0-25 to 6 mm ² in one operation Recommended for spring connections Dedicated applicator for each crimping tool for dispensing strips For right and left-handed usage 4 point crimping for Cat. Nos. 0367 08/09 3 point crimping for Cat. No. 0367 10	
1	0376 08	For ferrules with 0-25 and 0-34 mm² cross sections Supplied with empty applicator fitted	
1	0376 09	For ferrules with 0-5 to 2-5 mm² cross sections Fitted with an adjustment wheel Supplied with empty applicator fitted	
1	0376 10	For ferrules with 4 and 6 mm² cross sections Fitted with an adjustment wheel Supplied complete with empty applicator	
1	0376 39	Transport case for on-site use Assorted kit, comprising : - 1 Starfix crimping tool, Cat. No. 0376 09 with empty applicator fitted - 120 x 0-5 mm ² ferrules - 120 x 0-75 mm ² ferrules - 240 x 1-0 mm ² ferrules - 320 x 1-5 mm ² ferrules - 200 x 2-5 mm ² ferrules	
1	0376 97	Multi-purpose crimping tool for 0-5 to 2-5 mm² cross sections Tool cuts, strips, twists, crimps Supplied complete with 5 empty applicators	
		Crimping tool for single and double ferrules	
		Starfix crimping tool for 0-25 to 6 mm² cross sections For 4-point crimping of ferrules from 0-25 to 6 mm ² Recommended for spring connections Crimping tool with disengageable control system, crimping at end For right and left-handed usage	
1	0376 06		
1	0376 92	Transport case for on-site use Assorted kit. Supplied with : - 1 tool with crimping operation control system for individual ferrules 10 to 50 mm ² - 30 individual ferrules 10 mm ² - 20 individual ferrules 16 mm ² - 15 individual ferrules 25 mm ² - 10 individual ferrules 35 mm ² - 10 individual ferrules 50 mm ²	

applicators for Starfix® crimping tools

Starfix® ferrules, crimping tools and applicators



0376 47

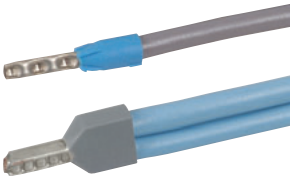

Example of single/double ferrules fitted on cables



Example of different cables and ferrules

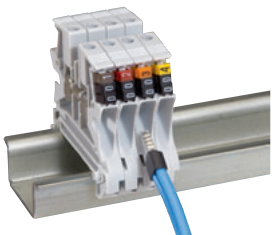

Example of use with Viking 3 terminals

Technical information (opposite)

Pack	Cat. Nos.	Starfix applicators
		For Starfix crimping tools
		For dispensing strips of ferrules in Starfix crimping tools Cat. Nos. 0376 08/09/10/97
		For ferrules cross section (mm ²)
10	0376 46	0.25 and 0.34
10	0376 47	0.5 to 2.5
10	0376 48	4 and 6
		Colour
		yellow
		red
		orange

Correspondance table

Cross section (mm ²)			
	Single ferrule	Large capacity ferrule - refills	Starfix applicator
0.5	0376 61	0376 41	0376 47
0.75	0376 62	0376 42	0376 47
1.0	0376 63	0376 43	0376 47
1.5	0376 64	0376 44	0376 47
2.5	0376 66	0376 45	0376 47

Dimensions (mm)

Single ferrules

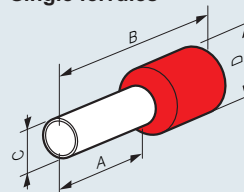

Cat. Nos.	Cross section (mm ²)	A	B	C	D	
0376 50	0.25	8	14.5	1.1	3	
0376 60	0.34	8	14.5	1.1	3	
0376 61	0.5	8	14.5	1.5	3.4	
0376 62	0376 42	0.75	8	14.5	1.5	3.4
0376 63	0376 43	1.0	8	14.5	1.7	3.6
0376 64	0376 44	1.5	8	14.5	2	4.1
0376 66	0376 45	2.5	8	14.5	2.6	4.8
0376 67	4	12	21	3.2	5.7	
0376 68	6	12	23	3.9	7.2	
0376 69	10	12	21	4.9	8.1	
0376 70	16	18	29	6.3	9.8	
0376 71	25	18	31	7.9	12	

Double ferrules

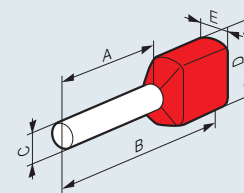

Cat. Nos.	Cross section (mm ²)	A	B	C	D	E
0376 87	2 x 0.75	8	15	2.1	6	3.3
0376 88	2 x 1.0	8	15	2.35	6	4
0376 89	2 x 1.5	8	16	2.6	7.2	4.2
0376 90	2 x 2.5	10	18.5	3.3	8.4	4.8

Starfix crimping tool usage example



1 Fit the applicator



2 Adjust



The handle gives an excellent grip



3 Insert the cable



4 Crimp

Industrial plugs, sockets and combination units

Hypra® Prisinter
IP 44/55



P. 168
Selection chart IP 44/55
panel and surface
mounting sockets
LV 16/32/63 A

Hypra®
IP 44



P. 174
Selection chart IP 44
plugs and sockets
ELV 16 A and
LV 16/32/63 A

Hypra®
IP 66/67-55



P. 180
Selection chart
IP 66/67-55
plugs and sockets
LV 16/32/63/125 A

P 17 Tempra®
IP 44



P. 188
Selection chart IP 44
plugs and sockets
LV 16/32 A

P 17 Tempra®
IP 66/67



P. 188
Selection chart IP 66/67
plugs and sockets
LV 16/32/63 A

Hypra®
combination units
IP 44, IP 66/67-55



P. 196
IP 44
combination units
16/32/63 A

P 17 Tempra®
combination units
IP 44/IP 55/IP 66



P. 200
IP 44
combination units
LV 16/32 A

P 17 Tempra®
self assembly
combination units
IP 44

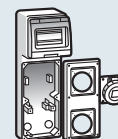

P. 201
Self assembly
IP 44
LV 16/32 A

NEW IN 2012



Hypra®
IP 66/67-55
Angled plugs
(p. 181)



P. 168
IP 44/55
panel and surface
mounting sockets
LV 16 A



P. 169
IP 44/55
panel and surface
mounting sockets
LV 32 A



P. 169
IP 44/55
panel and surface
mounting sockets
LV 63 A



P. 170
Technical
information

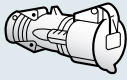

P. 175 NEW
IP 44
plugs and sockets
ELV 16 A and
LV 16 A

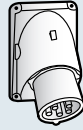

P. 176 NEW
IP 44
plugs and sockets
LV 32 A

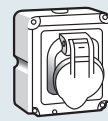

P. 176
IP 44
plugs and sockets
LV 63 A



P. 177
Technical
information

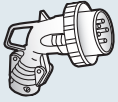

P. 181 NEW
IP 66/67-55
plugs and sockets
LV 16 A

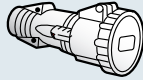

P. 182
IP 66/67-55
plugs and sockets
LV 32 A

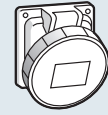

P. 182
IP 66/67-55
plugs and sockets
LV 63/125 A



P. 183
Technical
information

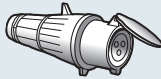

P. 189
IP 44
plugs and sockets
LV 16 A

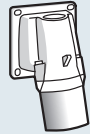

P. 189
IP 44
plugs and sockets
LV 32 A



P. 190
Technical
information

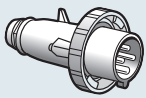

P. 192
IP 66/67
plugs and sockets
LV 16 A

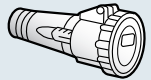

P. 192
IP 66/67
plugs and sockets
LV 32 A

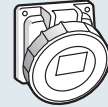

P. 192
IP 66/67
plugs and sockets
LV 63 A



P. 192
Technical
information



P. 196
IP 44
combination units
with Prisinter
LV 16/32 A



P. 197
IP 66/67-55
combination units
LV 16/32/63 A



P. 198
Technical
information



P. 200
IP 55
combination units
LV 16/32 A



P. 200
IP 66
combination units
LV 16/32/63 A



P. 202
Technical
information

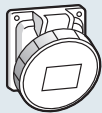

P. 201
Sockets for
self assembly units
LV 16/32 A



P. 202
Technical
information



P. 204
Plugs and sockets
pin configurations

Industrial plugs, sockets and combination units

A choice of plugs, sockets and combination units, each designed to meet the individual needs of specific areas of the market. From the everyday simplicity of P17 Tempra to the rugged sophistication and additional security presented by Hypra, which is further enhanced by its unique interlocked load break Prisinter sockets range.

HYPRA - tough, durable reliability

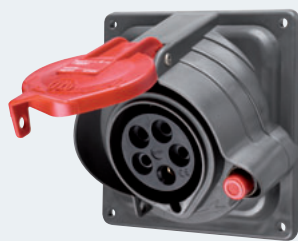

Hypra Prisinter sockets

- Unique interlocked load break
- Padlockable cover
- Compact combined socket and switch
- Surface and panel mounting options
- Available in plastic and metal versions

TECH INFO -

- IP44/55
- IK09 (plastic)
- IK10 (metal)



Hypra plugs and sockets

- Full range of plugs, mobile sockets, appliance inlets and panel mounting sockets
- Available in plastic and metal

TECH INFO -

- IP44 and IP66/67-55 ranges
- IK09 (plastic)
- IK10 (metal)

Power where you need it, when you need it... whatever the weather



In good company

Over 1,000 Hypra combination units were installed by the MET office as part of its comprehensive electrical upgrading programme.

The units manage and isolate mains electricity and were chosen for their durability, ease of servicing and low maintenance... together with great flexibility and functionality.

P17 TEMPRA – innovative simplicity



P17 Tempra plugs and sockets

- Full range of plugs, mobile sockets, appliance inlets and panel mounting sockets
- Available in plastic only

TECH INFO –

- IP44 and IP66/67 ranges
- IK09

COMBINATION UNITS – rugged versatility



Hypra combination units

- Available with Hypra Prisinter or Hypra panel mounted sockets
- RCD, MCB or RCBO protection options

TECH INFO –

- IP44 and IP66/67-55 ranges
- IK09



P17 Tempra combination units

- Available pre-assembled, or as self assembly version
- Available with or without protection

TECH INFO –

- IP44, IP55 and IP66 ranges
- IK08

Legrand's extended product family

With quality being paramount throughout its product portfolio, Legrand is in an unbeatable position... offering high quality, integrated solutions designed to meet your needs whatever the budget or installation requirements.



Enclosures
see p. 8 to 45



MCBs
see p. 79 to 82



RCDs
see p. 83

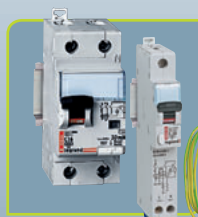

RCBOs
see p. 84

Hypra[®] Prisinter...

take a load off your mind

With its unique interlocked load break, the Prisinter is a key asset to the Hypra range and is available in 16, 32 and 63 A ratings.

FEATURES:

- **Combined socket and switch** - saving space, cost and installation time
- **Unique interlocked load break system** - prohibits on load connection or disconnection for maximum safety
- **Padlockable cover** - for additional security
- **Brass contact sleeves** - create high quality, reliable connections
- **Stainless steel screws** - maximum durability

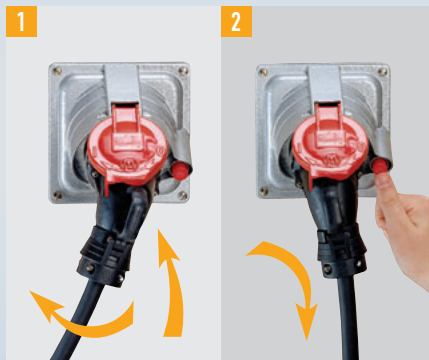

1. Turn the plug to lock in position and connect power
2. Press the isolator button to disconnect power and remove the plug

A simple, safe unique innovation

The added safety provided by load break prior to disconnection is equivalent to that provided by safety shutters on domestic sockets.

TECHNICAL DATA

APPROVALS: BS EN 60309-1, BS EN 60309-2

Products are interchangeable with other manufacturers' products which meet the BS EN 60309-2 standard

PROTECTION: IP 44 - with Hypra IP 44 straight plug connected, IP54 - with Hypra IP67/66-55 straight plug connected, IP55 - with flap shut or Hypra IP66/67-55 angled plug connected
IK09 for plastic sockets, IK10 for metal sockets

SELF EXTINGUISHING: 960°C for insulated parts, 650°C for housing

OPERATING TEMPERATURE: -20°C / +100°C

HYPRA PRISINTER - the choice is yours



Panel mounting (plastic and metal options)



Surface mounting (plastic and metal options)

Safe and adaptable power supply for TATA steel Colorcoat® PV Facility

Prisinter sockets and Hypra plugs were specified retrospectively for TATA in a facility which requires machinery to be moved on a regular basis. Machines, originally wired directly to Zucchini tap-offs, are now wired into Hypra plugs, and simply connected and disconnected as required under the safety of Prisinter's interlocked load break switch.



Hypra Prisinter socket, Hypra angled plug and Zucchini tap-off

Related products and accessories



IP44 plugs
see p. 172 to 179



IP66/67-55 plugs
see p. 180 to 185

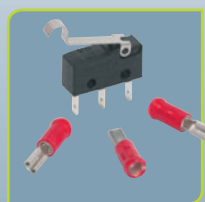

Auxiliary c/o contact
see p. 168

An innovative answer to safe, secure power connections

Hypra® Prisinter IP 44/55 - LV 16/32/63 A selection chart

Conform to :
 BS EN 60309-1,
 BS EN 60309-2,
 IP 44 when plug inserted
 IP 54 with cover closed
 or used with IP 66/67-55
 straight plugs
 IP 55 with cover closed
 or used with IP 66/67-55
 angled plugs
 IK 09 (plastic)
 IK 10 (metal)
 Self-extinguishing : 960 °C
 650 °C for housing
 Temp. rating :
 -20 °C to +100 °C

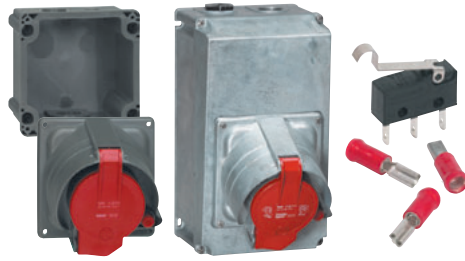

Technical information and dimensions (p. 170-171)

Prisinter

			Panel mounting sockets		Surface mounting sockets		Auxiliary c/o contact microswitch
LV			METAL	PLASTIC	METAL	PLASTIC	
100 to 130 V 50/60 Hz	16 A	2 P + ⊥	–	0519 10	–	0519 10+ 0520 49	0521 96
		2 P + ⊥	–	0520 02	–	0520 02+ 0520 49	0521 96
200 to 250 V 50/60 Hz	16 A	3 P + ⊥	–	0520 03	–	0520 03+ 0520 49	0521 96
		3 P + N + ⊥	–	0520 04	–	0520 04+ 0522 49	0521 96
		2 P + ⊥	–	0527 02	–	0527 02+ 0529 49	0521 96
	32 A	3 P + ⊥	–	0527 03	–	0527 03+ 0529 49	0521 96
380 to 415 V 50/60 Hz	16 A	3 P + ⊥	0522 13	0522 03	0522 13+ 0520 59	0522 03+ 0520 49	0521 96
		3 P + N + ⊥	0522 14	0522 04	0522 14+ 0529 59	0522 04+ 0522 49	0521 96
	32 A	3 P + ⊥	0529 13	0529 03	0529 13+ 0522 59	0529 03+ 0529 49	0521 96
		3 P + N + ⊥	0529 14	0529 04	0529 14+ 0522 59	0529 04+ 0529 49	0521 96
	63 A	3 P + ⊥	0538 00	0536 03	0538 00+ 0538 09	0536 03+ 0537 49	0521 96
		3 P + N + ⊥	0538 01	0536 04	0538 01+ 0538 09	0536 04+ 0537 49	0521 96

For voltages/arrangements not listed in this table, please contact us on +44 (0) 845 605 4333

For pack quantities, see opposite and p.169

Hypra® Prisinter IP 44/55 - LV 16 A interlocked switched sockets



0520 02



Turn plug to lock in position and connect power



Press the isolator button to disconnect power and remove the plug



0522 13



0522 49



Technical information and dimensions (p. 170-171)
 Conformity to International Standards (p. 204)

Conform to BS EN 60309-1, BS EN 60309-2
 IP 44 when plug inserted
 IP 54 when used with IP 66/67-55 straight plugs
 IP 55 with cover closed or used with IP 66/67-55 angled plugs
 IK 09 (plastic)
 IK 10 (metal)
 Stainless steel screws
 Brass contacts

Pack	Cat. Nos.		Prisinter panel mounting sockets 16 A
	Metal	Plastic	Load break disconnect at the push of the button Accepts Ø6 mm padlock with cover closed Terminals accept 1.5 mm ² to 4 mm ² rigid cable (BS EN 60309-1 and IEC 60309-1) Possibility to fit 2 auxiliary C/O contacts Cat. No. 0521 96
1			 100/130 V~
			 200/250 V~
1			2 P + ⊥
1			3 P + ⊥
1			3 P + N + ⊥
			 380/415 V~
1	0522 13	0522 03	3 P + ⊥
1	0522 14	0522 04	3 P + N + ⊥

Surface mounting boxes

Enable Hypra Prisinter panel mounting sockets to be surface mounted
 Reversible entry box with 3 x M20 entries with 2 blanking plugs plus rear knockout entries

	Metal	Plastic	
1	0520 59	0520 49	For 2 P + ⊥ / 3 P + ⊥ sockets
1	0529 59	0522 49	For 3 P + N + ⊥ sockets



For IP 44 straight plugs

see p. 174



For IP 66/67-55 angled and straight plugs

see p. 180

Hypra® Prisinter IP 44/55 - LV 32 A

interlocked switched sockets



0529 13



Turn plug to lock in position and connect power



Press the isolator button to disconnect power and remove the plug



0529 04 + 0529 49

Technical information and dimensions (p. 170-171)
Conformity to International Standards (p. 204)

Conform to BS EN 60309-1, BS EN 60309-2
 IP 44 when plug inserted
 IP 54 when used with IP 66/67-55 straight plugs
 IP 55 with cover closed or used with IP 66/67-55 angled plugs
 IK 09 (plastic)
 IK 10 (metal)
 Stainless steel screws
 Brass contacts

Pack	Cat. Nos.		Prisinter panel mounting sockets 32 A
	Metal	Plastic	Load break disconnect at the push of the button Accepts Ø6 mm padlock with cover closed Terminals accept 2.5 mm ² to 10 mm ² rigid cable (BS EN 60309-1 and IEC 60309-1) Possibility to fit 2 auxiliary C/O contacts Cat. No. 0521 96
1		0527 02	200/250 V~ 2 P + ⊥
1		0527 03	3 P + ⊥
1	0529 13	0529 03	380/415 V~ 3 P + ⊥
1	0529 14	0529 04	3 P + N + ⊥

Pack	Cat. Nos.		Surface mounting boxes
1	Metal	Plastic	Enable Hypra Prisinter panel mounting sockets to be surface mounted Reversible entry box with 2 x M25 and 1 x M20 entries with 1 x M25 and 1 x M20 blanking plugs plus rear knockout entries
1	0522 59	0529 49	For 2 P + ⊥ / 3 P + ⊥ / 3 P + N + ⊥ sockets

Hypra® Prisinter IP 44/55 - LV 63 A

interlocked switched sockets



0538 00 + 0538 09



Turn plug to lock in position and connect power



Press the isolator button to disconnect power and remove the plug

Technical information and dimensions (p. 170-171)
Conformity to International Standards (p. 204)

Conform to BS EN 60309-1, BS EN 60309-2
 IP 44 when plug inserted
 IP 54 when used with IP 66/67-55 straight plugs
 IP 55 with cover closed or used with IP 66/67-55 angled plugs
 IK 09 (plastic)
 IK 10 (metal)
 Stainless steel screws
 Brass contacts

Pack	Cat. Nos.		Prisinter panel mounting sockets 63 A
	Metal	Plastic	Load break disconnect at the push of the button Accepts 3 x Ø8 mm padlocks with cover closed IP 2x protection against direct contact Terminals accept 6 mm ² to 25 mm ² rigid cable Possibility to fit 2 auxiliary C/O contacts Cat. No. 0521 96
1	0538 00	0536 03	380/415 V~ 3 P + ⊥
1	0538 01	0536 04	3 P + N + ⊥

Pack	Cat. Nos.		Surface mounting boxes
1	Metal	Plastic	Enable Hypra Prisinter panel mounting sockets to be surface mounted Reversible entry box with 2 x M32 and 1 x M20 entries with 1 x M32 and 1 x M20 blanking plugs
1	0538 09	0537 49	For 3 P + ⊥ / 3 P + N + ⊥ sockets

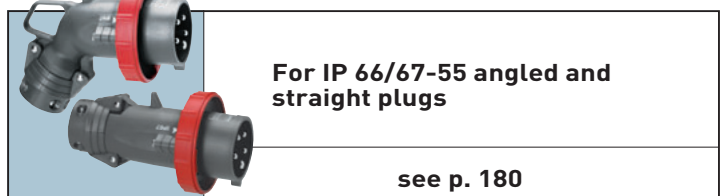
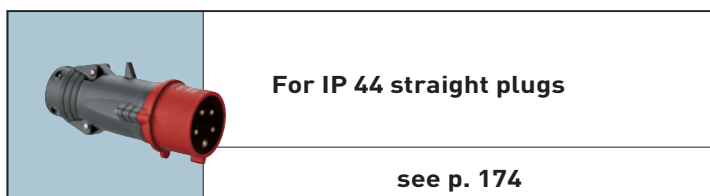

Hypra® Prisinter IP 44/55 - LV 16/32/63 A

panel mounting interlocked switched sockets

■ Technical information

Icc 10 kA according to BS EN 60309-1, BS EN 60309-2, IEC 60309-1 and IEC 60309-2

IP rating according to BS EN 60529 and IEC 60529 :

IP 44 when plug inserted

IP 54 when used with IP 66/67-55 straight plugs

IP 55 with cover closed or used with IP 66/67-55 angled plugs

Resistance to glow wire and dielectric strength

Glow wire :

960° C for live part supports

650° C for other parts

Dielectric strength : 3 000 V 50 Hz

Temperatures

-20 °C to + 100 °C (+80 °C with auxiliary fitted)

Installation : -20 °C / +40 °C

Use : -20 °C / +100 °C

Hypra Prisinter breaking capacity at 3 x 400 V \sim according to BS EN 60947-1, BS EN 60947-3, IEC 60947-1 and IEC 60947-3 :

Category	16 A	32 A	63 A
AC 1	16 A	32 A	63 A
AC 23	8.4 kW	16.8 kW	33 kW
AC 3	8.4 kW	16.8 kW	33 kW

IK according to BS EN 62262 and IEC 62262

IK 09 : Plastic

IK 10 : Metal

Stainless steel screws

Brass contacts

■ Dimensions

Prisinter panel mounting sockets IP 44/55 - LV 16/32/63 A

(p. 168-169)

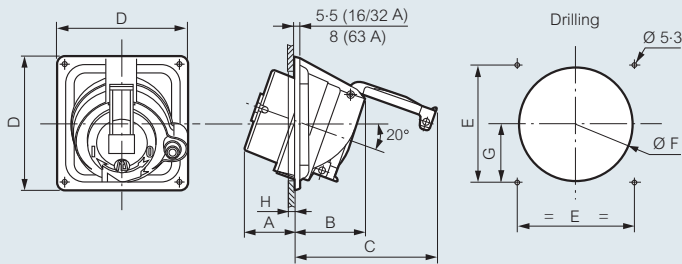

	Material	Weight (kg)	A (mm)	B (mm)	C (mm)	D (mm)	E (mm)	F (mm)		G (mm)	H (mm)
								min.	max.		max.
LV 16 A											
2 P + \perp	Plastic	0.42	46	70	132	115	100	92	98	46	6 to 10
3 P + \perp	Plastic	0.48	46	70	138	115	100	92	96	46	6 to 10
	Metal	1.33									
3 P + N + \perp	Plastic	0.57	46	75	156	125	110	102	106	51.5	7
	Metal	1.47									
LV 32 A											
2 P + \perp	Plastic	0.57	54	77	153	143	125	115	122	58.5	10 to 20
3 P + \perp	Plastic	0.61	54	77	153	143	125	115	122	58.5	10 to 20
	Metal	1.5									
3 P + N + \perp	Plastic	0.65	55	79	169	143	125	119	122	58.5	9 to 13
	Metal	1.8									
LV 63 A											
3 P + \perp	Plastic	0.95	55	99	205	143	125	120	122	59.5	10 to 20
	Metal	1.85									
3 P + N + \perp	Plastic	0.98	55	99	205	143	125	120	122	59.5	10 to 20
	Metal	2.2									

■ Accessories

Auxiliary contacts (-20 °C to +80 °C)

Prisinter sockets can accommodate two c/o auxiliary contacts (late make/early break) Cat. No. 0521 96 p. 168

These may be used to signal to a central control/monitoring station or control a contactor to remove load

Padlockable cover in closed position

Hypra® Prisinter IP 44/55

surface mounting back boxes

■ Dimensions

LV 16 A (p. 168)

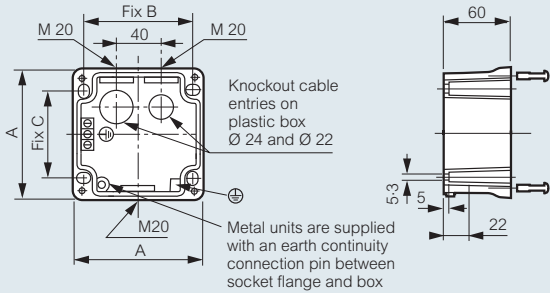

3 x M20 entries with 2 x M20 blanking plugs

Equipped with :

2 earth terminals inside and 1 external (metal box)

2 earth terminals inside (plastic box)

	Material	Weight (kg)	A (mm)	B (mm)	C (mm)
2 P + ⊕	Plastic	0-14	115	97	78
3 P + ⊕					
3 P + N + ⊕	Plastic	0-16	125	107	88
	Metal	0-9			

LV 32 A (p. 169)

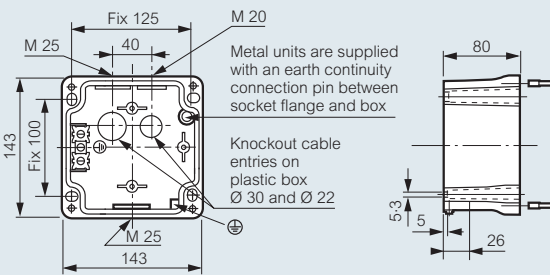

Reversible boxes

1 x M20 entry with 1 x M20 blanking plug

2 x M25 entries with 1 x M25 blanking plug

Equipped with :

2 earth terminals inside and 1 external (metal box)

1 earth terminal inside (plastic box)

Material	Weight (kg)
Plastic	0-3
Metal	1-7

LV 63 A (p. 169)

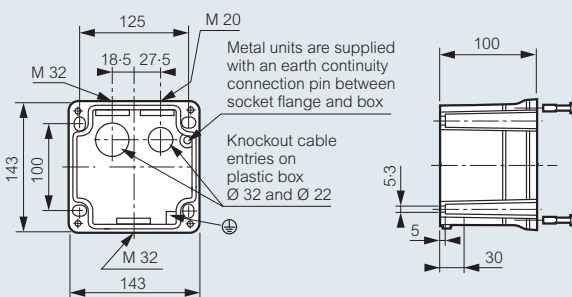

Reversible boxes

1 x M20 entry with 1 x M20 blanking plug

2 x M32 entries with 1 x M32 blanking plug

Equipped with external earth terminal on the metal box

Material	Weight (kg)
Plastic	0-35
Metal	1-75

■ Box entries

Prisinter boxes can be rotated to aid entry

LV 16/32 A

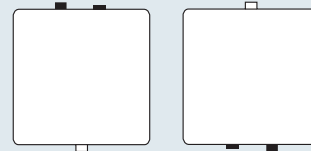

LV 63 A

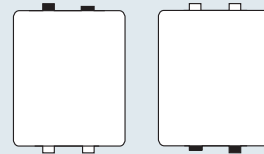

Hypra[®] plugs and sockets...

for when the going gets tough



The Hypra range is aimed at installations where maximum durability is a must... including the nuclear, chemical and process industries.

The highest levels of protection and reliability

Available in IP44 and IP66/67-55 rated versions and manufactured in Polyamide 6, Hypra plugs and sockets are ideal for use in harsh and demanding environments.

The plastic and rubber units are IK09 rated, while the class leading metal units are IK10 rated – the highest rating for impact.

FEATURES:

- **Integrated cable gland on entire IP66/67-55 range** - providing the highest levels of ingress protection
- **Captive, slotted connection screws** - for fast secure connections
- **Nickel-plated brass pins and contact sleeves** - creating high quality, reliable connections
- **Captive, stainless steel external screws** - maximise durability
- **Double jaw cable clamps** - provide powerful cable fastening
- **Available in 2 ranges** - IP44 and IP66/67-55



UNDERSTANDING THE IP66/67-55 RATING

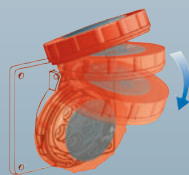

IP 55 assured automatically with cover flap down without locking ring secured

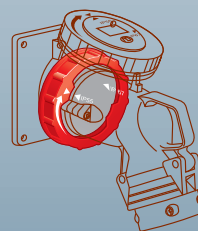

IP 55 guaranteed with IP 66/67-55 plug inserted and cover in place over spigot on plug

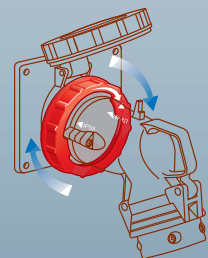

IP 66/67-55 obtained with locking ring secured

HYPRA PLUGS AND SOCKETS – options for every application



Straight / angled plugs and mobile sockets

CURRENT RATING – 16A, 32A, 63A, 125A
VOLTAGES – 20-25V, 20-50V, 110V, 240V, 400V
PIN CONFIG – 2P, 3P, 2P+E, 3P+E, 3P+N+E
IP RATING – IP44, IP66/67-55

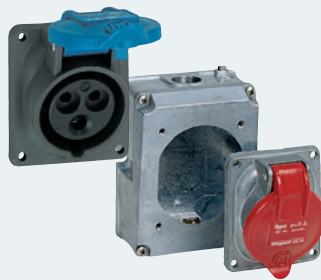

Surface / panel mounting socket outlets

CURRENT RATING – 16A, 32A, 63A, 125A
VOLTAGES – 20-25V, 20-50V, 110V, 240V, 400V
PIN CONFIG – 2P, 3P, 2P+E, 3P+E, 3P+N+E
IP RATING – IP44, IP66/67-55



Appliance inlets

CURRENT RATING – 16A, 32A, 63A, 125A
VOLTAGES – 20-25V, 20-50V, 110V, 240V, 400V
PIN CONFIG – 2P, 3P, 2P+E, 3P+E, 3P+N+E
IP RATING – IP44, IP66/67-55

TECHNICAL DATA

APPROVALS: BS EN 60309-1
 BS EN 60309-2
 BS EN 60529 (IP)
 BS EN 62262 (IK)

Products are interchangeable with other manufacturers' products which meet the BS EN 60309-2 standard

PROTECTION: IP44 and IP66/67-55 ranges available
 IK09 for plastic products, IK10 for metal products

SELF EXTINGUISHING: 850°C for insulated parts, 650°C for housing

OPERATING TEMPERATURE: -50°C to +100°C

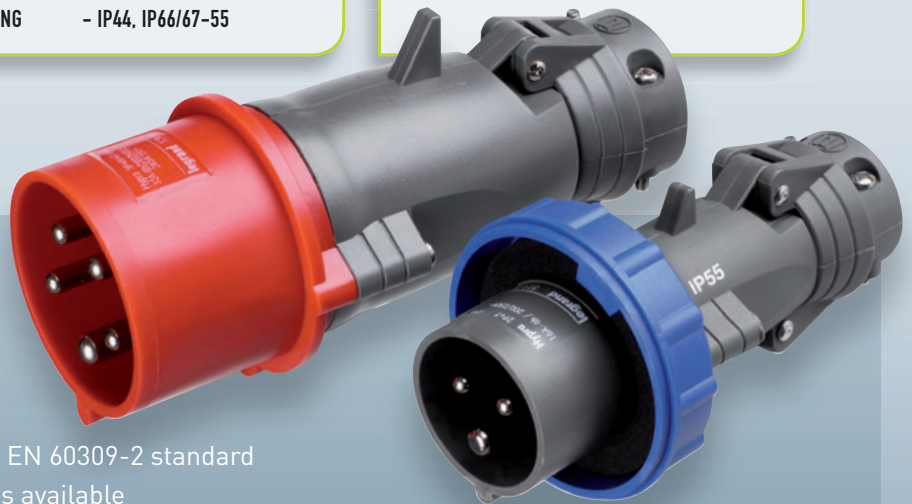

Hypra® plugs and sockets IP 44 - ELV 16 A and LV 16/32/63 A selection chart

Conform to :
 BS EN 60309-1, BS EN 60309-2,
 IEC 60309-1 and IEC 60309-2
 IP 44 according to
 BS EN 60529 and IEC 60529
 IK 09 plastic
 IK 10 metal according to
 BS EN 62262 and IEC 62262
 Self-extinguishing :
 850 °C for insulated parts
 650 °C for housing -
 conforms to BS EN 60695-2-10
 and IEC 60695-2-10
 Temp. rating : -50 °C to +100 °C



(Covers available, see bottom of page)



Technical information and dimensions (p. 177-179)

ELV			PLASTIC	PLASTIC	PLASTIC	SURFACE MOUNTING SOCKETS		THROUGH ENTRY SURFACE MOUNTING SOCKETS	PANEL MOUNTING SOCKETS		
ELV			PLASTIC	PLASTIC	PLASTIC	METAL	PLASTIC	PLASTIC	METAL	PLASTIC	MODULAR ⁽¹⁾
20 to 25 V 50/60 Hz	16 A	2 P	0524 21	0524 61	–	–	0524 01+ 0524 19	–	–	0524 01	–
		3 P	0524 22	0524 62	–	–	0524 02+ 0524 19	–	–	0524 02	–
20 to 50 V D.C. ∴	16 A	2 P	0524 25	–	–	–	0524 05+ 0524 19	–	–	0524 05	–
LV											
100 to 130 V 50/60 Hz	16 A	2 P+ ⊥	0519 40	0519 80	0519 70	–	0519 20+ 0520 29	0519 20+ 0520 89	0519 30	0519 20	0519 19
200 to 250 V 50/60 Hz	16 A	2 P+ ⊥	0520 42	0520 82	0521 72	–	0520 22+ 0520 29	0520 22+ 0520 89	0520 32	0520 22	0520 18
		3 P+ ⊥	0520 43	0520 83	0520 73	–	0520 23+ 0522 29	0520 23+ 0522 89	0520 33	0520 23	0520 19
		3 P+N+ ⊥	0520 44	0520 84	–	–	0520 24+ 0522 29	0520 24+ 0522 89	0520 34	0520 24	–
380 to 415 V 50/60 Hz	32 A	2 P+ ⊥	0527 42	0527 82	0528 72	–	0527 18+ 0529 40	0527 18+ 0529 90	0527 32	–	0527 18
		3 P+ ⊥	0527 43	0527 83	–	–	0527 19+ 0529 40	0527 19+ 0529 90	0527 33	–	0527 19
380 to 415 V 50/60 Hz	16 A	3 P+ ⊥	0522 43	0522 83	0521 73	0522 33+ 0522 39	0522 23+ 0522 29	0522 23+ 0522 89	0522 33	0522 23	0522 19
		3 P+N+ ⊥	0522 44	0522 84	0521 74	0522 34+ 0522 39	0522 24+ 0522 29	0522 24+ 0522 89	0522 34	0522 24	0522 20
	32 A	3 P+ ⊥	0529 43	0529 83	0528 73	0529 33+ 0529 39	0529 19+ 0529 40	0529 19+ 0529 90	0529 33	–	0529 19
		3 P+N+ ⊥	0529 44	0529 84	0528 74	0529 34+ 0529 39	0529 20+ 0529 40	0529 20+ 0529 90	0529 34	–	0529 20
	63 A	3 P+ ⊥	0538 43	0538 83	0537 73	–	–	–	0538 33	0538 23	–
		3 P+N+ ⊥	0538 44	0538 84	0537 74	–	0537 24	–	0538 34	0538 24	–

(1) Modular sockets are manufactured from plastic with 70 x 70 mm fixing centres

For voltages/arrangements not listed in this table,
 please contact us on +44 (0) 845 605 4333
 For pack quantities, p. 175-176

Modular sockets have 70 x 70 mm fixing centres across 16 A and 32 A range

see p. 175-176

APPLIANCE INLET COVERS

Conform to :
 BS EN 60309-1,
 BS EN 60309-2,
 IEC 60309-1 and
 IEC 60309-2
 Material : Rubber
 Self-extinguishing :
 650 °C
 Temp. rating :
 -20 °C to +40 °C



Dimensions (p. 177)

		Pack	Cat. Nos.
16 A	2 P+ ⊥	10	0521 25
	3 P+ ⊥	5	0521 26
	3 P+N+ ⊥	5	0521 27
32 A	2 P+ ⊥	5	0521 27
	3 P+ ⊥	5	0521 27
	3 P+N+ ⊥	5	0527 99
63 A	3 P+ ⊥	5	0536 99
	3 P+N+ ⊥	5	0536 99

Hypra® IP 44 - ELV 16 A and LV 16 A

metal and plastic plugs and sockets



0524 61



0522 44



0520 82



0521 73



0522 33 + 0522 39

Technical information and dimensions (p. 177-179)
Conformity to International Standards (p. 204)

Conform to BS EN 60309-1, BS EN 60309-2, IEC 60309-1 and IEC 60309-2
 IP 44 according to BS EN 60529 and IEC 60529

IK 09 plastic

IK 10 metal according to BS EN 62262 and IEC 62262

Self-extinguishing : 850 °C for insulated parts

650 °C for housing - conforms to BS EN 60695-2-10 and IEC 60695-2-10

Temp. rating : -50 °C to +100 °C

Nickel plated brass contacts



0520 22



0522 19

Pack Cat. Nos. Straight plugs 16 A

Pack	Cat. Nos.	Configuration	Voltage
5	0524 21	2 P	20 to 25 V~
	0524 22	3 P	
1	0524 25	2 P	20 to 50 V=
	0519 40	2 P + ⊥	
5	0520 42	2 P + ⊥	100 to 130 V~
	0520 43	3 P + ⊥	
1	0520 44	3 P + N + ⊥	200 to 250 V~
5	0522 43	3 P + ⊥	
1	0522 44	3 P + N + ⊥	

Mobile sockets 16 A

Pack	Cat. Nos.	Configuration	Voltage
1	0524 61	2 P	20 to 25 V~
	0524 62	3 P	
1	0519 80	2 P + ⊥	100 to 130 V~
	0520 82	2 P + ⊥	
1	0520 83	3 P + ⊥	200 to 250 V~
1	0520 84	3 P + N + ⊥	
1	0522 83	3 P + ⊥	380 to 415 V~
1	0522 84	3 P + N + ⊥	

Panel appliance inlets 16 A

Pack	Cat. Nos.	Configuration	Voltage
1	0519 70	2 P + ⊥	100 to 130 V~
	0521 72	2 P + ⊥	
1	0520 73	3 P + ⊥	200 to 250 V~
	0521 73	3 P + ⊥	
1	0521 74	3 P + N + ⊥	380 to 415 V~
1	0521 73	3 P + ⊥	
1	0521 74	3 P + N + ⊥	

Pack Cat. Nos. Panel mounting sockets 16 A

Pack	Cat. Nos.	Configuration	Voltage
5	0524 01	2 P	20 to 25 V~
	0524 02	3 P	
1	0524 05	2 P	20 to 50 V=
	0519 30	2 P + ⊥	
1	0519 20	2 P + ⊥	100 to 130 V~
	0519 30	2 P + ⊥	
1/5	0520 32	2 P + ⊥	200 to 250 V~
	0520 33	3 P + ⊥	
1	0520 24	3 P + N + ⊥	380 to 415 V~
	0520 24	3 P + N + ⊥	
1/5	0522 33	3 P + ⊥	100 to 130 V~
	0522 34	3 P + N + ⊥	
1	0519 19	2 P + ⊥	200 to 250 V~
	0519 19	2 P + ⊥	
5	0520 18	2 P + ⊥	380 to 415 V~
	0520 19	3 P + ⊥	
5	0522 19	3 P + ⊥	380 to 415 V~
	0522 20	3 P + N + ⊥	

Back boxes

Pack	Cat. Nos.	Configuration	Application
5	0524 19	Surface mounting boxes	For ELV 2 P / 3 P sockets
	0520 29	Surface mounting boxes	For LV 16 A 2 P + ⊥ sockets
	0522 39	Surface mounting boxes	For LV 16 A 3 P + ⊥ / 3 P + N + ⊥ sockets
1	0520 89	Through entry surface mounting boxes	For LV 16 A 2 P + ⊥ sockets
	0522 89	Through entry surface mounting boxes	For LV 16 A 3 P + ⊥ / 3 P + N + ⊥ sockets

Appliance inlet covers

Pack	Cat. Nos.	Application
10	0521 25	For LV 16 A 2 P + ⊥ appliance inlets
5	0521 26	For LV 16 A 3 P + ⊥ appliance inlets
5	0521 27	For LV 16 A 3 P + N + ⊥ appliance inlets

Hypra® IP 44 - LV 32 A

metal and plastic plugs and sockets



Technical information and dimensions (p. 177-179)
Conformity to International Standards (p. 204)

Conform to BS EN 60309-1, BS EN 60309-2, IEC 60309-1 and IEC 60309-2
 IP 44 according to BS EN 60529 and IEC 60529
 IK 09 plastic
 IK 10 metal according to BS EN 62262 and IEC 62262
 Self-extinguishing : 850 °C for insulated parts
 650 °C for housing - conforms to BS EN 60695-2-10 and IEC 60695-2-10
 Temp. rating : -50 °C to +100 °C
 Nickel plated brass contacts

Pack	Cat. Nos.		Straight plugs 32 A
1	Plastic		200 to 250 V~
1	0527 42		2 P + ⊥
1	0527 43		3 P + ⊥
1	0529 43		380 to 415 V~
1	0529 44		3 P + ⊥
1			3 P + N + ⊥
Mobile sockets 32 A			
1	Plastic		200 to 250 V~
1	0527 82		2 P + ⊥
1	0527 83		3 P + ⊥
1	0529 83		380 to 415 V~
1	0529 84		3 P + ⊥
1			3 P + N + ⊥
Panel appliance inlets 32 A			
1	Plastic		Covers available, see below 200 to 250 V~
1	0528 72		2 P + ⊥
1	0528 73		380 to 415 V~
1	0528 74		3 P + ⊥
1			3 P + N + ⊥
Panel mounting sockets 32 A			
1	Metal		200 to 250 V~
1	0527 32	Modular 0527 18	2 P + ⊥
1	0527 33	0527 19	3 P + ⊥
1	0529 33	0529 19	380 to 415 V~
1	0529 34	0529 20	3 P + ⊥
1			3 P + N + ⊥
Back boxes			
1	Metal	Plastic	Surface mounting boxes
1	0529 39	0529 40	For LV 32 A 2 P + ⊥ / 3 P + ⊥ / 3 P + N + ⊥ sockets
5	Plastic		Through entry surface mounting boxes
5	0529 90		For LV 32 A 2 P + ⊥ / 3 P + ⊥ / 3 P + N + ⊥ sockets
Appliance inlet covers			
5	0521 27		For LV 32 A 2 P + ⊥ / 3 P + ⊥ appliance inlets
5	0527 99		For LV 32 A 3 P + N + ⊥ appliance inlets

Hypra® IP 44 - LV 63 A

metal and plastic plugs and sockets

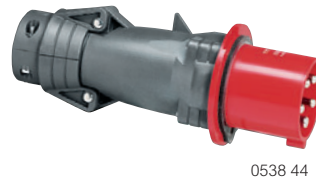

Technical information and dimensions (p. 177-179)

Conform to BS EN 60309-1, BS EN 60309-2, IEC 60309-1 and IEC 60309-2
 IP 44 according to BS EN 60529 and IEC 60529
 IK 09 plastic
 IK 10 metal according to BS EN 62262 and IEC 62262
 Self-extinguishing : 850 °C for insulated parts
 650 °C for housing - conforms to BS EN 60695-2-10 and IEC 60695-2-10
 Temp. rating : -50 °C to +100 °C
 Nickel plated brass contacts. 63 A units have a pilot pin

Pack	Cat. Nos.		Straight plugs 63 A
1	Plastic		380 to 415 V~
1	0538 43		3 P + ⊥
1	0538 44		3 P + N + ⊥
Mobile sockets 63 A			
1	Plastic		380 to 415 V~
1	0538 83		3 P + ⊥
1	0538 84		3 P + N + ⊥
Panel appliance inlets 63 A			
1	Plastic		380 to 415 V~
1	0537 73		3 P + ⊥
1	0537 74		3 P + N + ⊥
Surface mounting socket 63 A			
1	Plastic		380 to 415 V~
1	0537 24		3 P + N + ⊥
Panel mounting sockets 63 A			
1	Metal	Plastic	380 to 415 V~
1	0538 33	0538 23	3 P + ⊥
1	0538 34	0538 24	3 P + N + ⊥
Appliance inlet cover			
5	0536 99		For LV 63 A 3 P + ⊥ / 3 P + N + ⊥ appliance inlets

Hypra® IP 44 - ELV 16 A and LV 16/32/63 A

metal and plastic plugs and sockets

■ Technical information

IP 44 conforms to BS EN 60529 and IEC 60529
 Icc 10 kA according to BS EN 60309-1 and IEC 60309-1
 Stainless steel external screws - Nickel plated brass contacts
 IK according to BS EN 62262 and IEC 62262 : plastic = IK 09
 metal = IK 10

■ Wiring tested according to BS EN 60309-1

Type	Current	Conductors size (mm ²)	Conductors type
Straight plugs and mobile sockets	ELV 16 A	4 to 10	Flexible
	LV 16 A	1 to 2.5	Flexible
	LV 32 A	2.5 to 6	Flexible
	LV 63 A	6 to 16	Flexible
Panel appliance inlets	ELV 16 A	4 to 10	Rigid
	LV 16 A	1 to 2.5	Rigid
	LV 32 A	2.5 to 6	Rigid
Surface and panel mounting sockets	ELV 16 A	4 to 10	Rigid
	LV 16 A	1.5 to 4	Rigid
	LV 32 A	2.5 to 10	Rigid
	LV 63 A	6 to 25	Rigid

Tightening torque of connection screws

ELV 16 A : from 1 to 1.2 Nm
 LV 16 A : from 0.7 to 1 Nm
 LV 32 A : from 0.7 to 1 Nm
 LV 63 A : from 2 to 2.2 Nm for Phase and Earth
 from 0.7 to 1 Nm for pilot

■ Dimensions

Straight plugs IP 44

ELV 16 A, LV 16/32 A (p. 175-176)

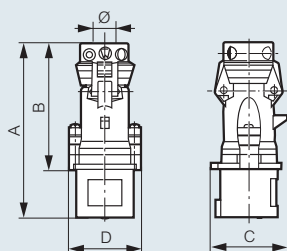

LV 63 A (p. 176)

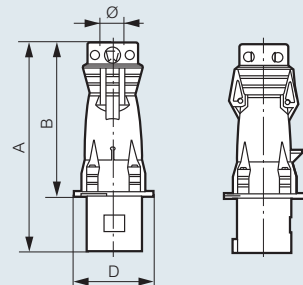

	Material	Weight (kg)	A	B	C	D	Ø Clamping and grip (mm)
ELV 16 A							
2 P	Plastic	0.180	142	107	62	55	8.5 to 22
LV 16 A							
2 P + ⊕	Plastic	0.150	135	100	57	55	8 to 15
3 P + ⊕	Plastic	0.175	139	103	65	60	8 to 15
3 P + N + ⊕	Plastic	0.210	154	118	73	66	10 to 18
LV 32 A							
2 P + ⊕	Plastic	0.260	164	119	78	70.5	10 to 18
3 P + ⊕	Plastic	0.260	164	119	78	70.5	12 to 22
3 P + N + ⊕	Plastic	0.300	170	125	86	77	12 to 22
LV 63 A							
3 P + ⊕	Plastic	0.640	255	188.5	-	102	18.5 to 29
3 P + N + ⊕	Plastic	0.700	255	188.5	-	102	20.5 to 32

■ Dimensions (continued)

Mobile sockets IP 44

ELV 16 A, LV 16/32 A (p. 175-176)

LV 63 A⁽¹⁾ (p. 176)

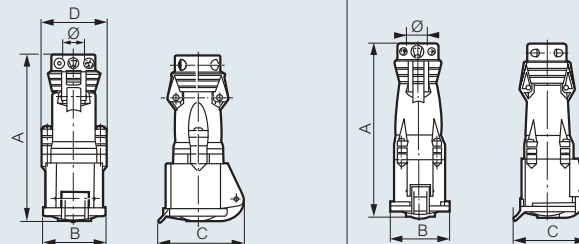

	Material	Weight (kg)	Dimensions (mm)				Ø Clamping and grip (mm)
			A	B	C	D	
ELV 16 A							
2 P	Plastic	0.190	148	54.5	74	55	8.5 to 22
LV 16 A							
2 P + ⊕	Plastic	0.170	147	54.5	74	55	8 to 15
3 P + ⊕	Plastic	0.200	151	61.5	81	60	8 to 15
3 P + N + ⊕	Plastic	0.245	172	69.5	90	66	10 to 18
LV 32 A							
2 P + ⊕	Plastic	0.300	177	71	93	70.5	10 to 18
3 P + ⊕	Plastic	0.300	177	71	93	70.5	12 to 22
3 P + N + ⊕	Plastic	0.350	183	77.5	100	77	12 to 22
LV 63 A							
3 P + ⊕	Plastic	0.770	273	96	119	-	18.5 to 29
3 P + N + ⊕	Plastic	0.830	273	96	119	-	20.5 to 32

Panel appliance inlets IP 44⁽¹⁾ (p. 175-176)

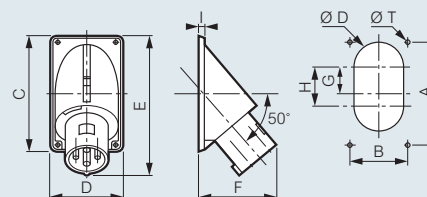

	Material	Weight (kg)	Drilling (mm)				Dimensions (mm)							
			A	B	Ø T	Ø D	G	H	C	D	E	F	I	
LV 16 A														
2 P + ⊕	Plastic	0.140	94	62	4.5	40	-	-	104	72	121	78	6	
3 P + ⊕	Plastic	0.160	109	83	4.5	40	-	-	120	94	135	86	6	
3 P + N + ⊕	Plastic	0.190	109	83	4.5	40	-	-	120	94	139	86	6	
LV 32 A														
2 P + ⊕	Plastic	0.280	149	90	5.5	40	-	-	160	101	176	111	6	
3 P + ⊕	Plastic	0.280	149	90	5.5	40	-	-	160	101	176	111	6	
3 P + N + ⊕	Plastic	0.320	149	90	5.5	40	-	-	160	101	174	108	6	
LV 63 A														
3 P + ⊕	Plastic	0.630	163	93	6.5	80	42	62	183	113	221	120	8	
3 P + N + ⊕	Plastic	0.690	163	93	6.5	80	42	62	183	113	221	120	8	

Appliance inlet covers (p. 175-176)

16/32/63 A

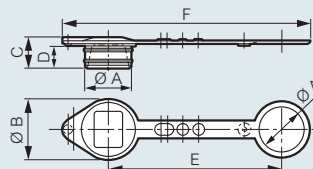

Cat. Nos.	Product	Ø A (mm)	Ø B (mm)	C (mm)	D (mm)	E (mm)	F (mm)
0521 25	16 A - 2 P + ⊕	38	50	26	18	140	200
0521 26	16 A - 3 P + ⊕	43	55	26	18	150	215
0521 27	16 A - 3 P + N + ⊕ 32 A - 2 P + ⊕, 3 P + ⊕	50	62	26	18	160	232
0527 99	32 A - 3 P + N + ⊕	56	68	26	18	167	248
0536 99	63 A - 2 P + ⊕, 3 P + ⊕, 3 P + N + ⊕	62	74	26	18	205	290

(1) Wiring diagram for 63 A shown on p. 179

Hypra® IP 44 - ELV 16 A and LV 16/32/63 A metal and plastic plugs and sockets (continued)

Hypra® IP 44 - ELV 16 A and LV 16/32 A surface mounting back boxes

■ Dimensions (continued)

Panel mounting sockets IP 44

ELV 16 A plastic and LV 16/32/63 A plastic and metal (p. 175-176)

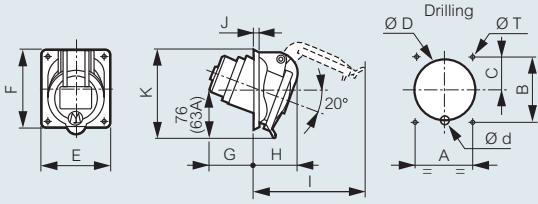

	Material	Weight (kg)	Drilling (mm)						Dimensions (mm)												
			A	B	C	ØD	Ød	ØT	E	F	G	H	I	J	K						
ELV 16 A																					
2 P	Plastic	0-120	52	60	30	55	-	4-2	64	72	33	47	94	5-5	78-5						
LV 16 A																					
2 P + ⊥	Plastic	0-110	52	60	28	55	14-5	4-2	64	72	41	40	94	5-5	78-5						
	Metal	0-340																			
3 P + ⊥	Plastic	0-140	60	70	31	63-5	14-5	5-2	74	84	44	40	98	5-5	88						
	Metal	0-405																			
3 P + N + ⊥	Plastic	0-165	60	70	33	70-6	-	5-2	80	84	44	44	110	5-5	93						
	Metal	0-450																			
LV 32 A																					
2 P + ⊥	Metal	0-605	70	80	38	76-2	10	5-2	84	94	50	53	120	5-5	103						
3 P + ⊥	Metal	0-605	70	80	38	76-2	10	5-2	84	94	50	53	120	5-5	103						
3 P + N + ⊥	Metal	0-660	70	80	38	76-2	10	5-2	84	94	52	56	124	5-5	107						
LV 63 A																					
3 P + ⊥	Plastic	0-640	77	85	-	92	-	6-5	106	106	98	70	160	6	129						
	Metal	1-000																			
3 P + N + ⊥	Plastic	0-700	77	85	-	92	-	6-5	106	106	98	70	160	6	129						
	Metal	1-200																			

LV 16/32 A plastic with modular fixings (p. 175-176)

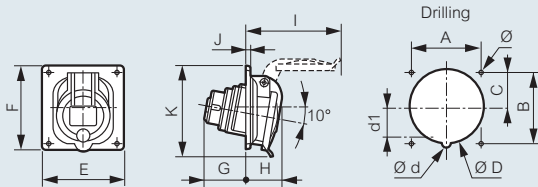

	Weight (kg)	Drilling (mm)						Dimensions (mm)													
		A	B	C	ØD	Ød	d1	E	F	G	H	I	J	K	Ø						
LV 16 A																					
2 P + ⊥	0-110	70	70	35	76-2	-	-	84	84	37	36	89	4-5	88	4-2						
3 P + ⊥	0-140	70	70	35	76-2	-	-	84	84	43	36	97	4-5	89	4-2						
3 P + N + ⊥	0-165	70	70	35	76-2	-	-	84	84	43	37	106	4-5	91	4-2						
LV 32 A																					
2 P + ⊥	0-220	70	70	35	76-2	-	-	84	94	54	45	117	4-5	100	4-2						
3 P + ⊥	0-220	70	70	35	76-2	-	-	84	94	54	45	117	4-5	100	4-2						
3 P + N + ⊥	0-255	70	70	35	76-2	8	36	84	94	54	46	125	4-5	102	4-2						

Surface mounting sockets IP 44

LV 63 A (p. 176)

Boxes can be rotated to aid entry

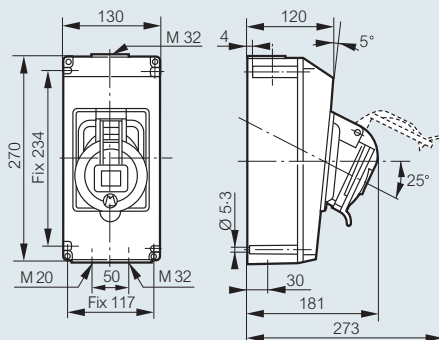

	Material	Weight (kg)
63 A		
3 P + ⊥	Plastic	1-50

■ Dimensions

Reversible boxes for surface mounting sockets
Boxes can be rotated to aid entry

ELV 16 A, LV 16 A (p. 175)

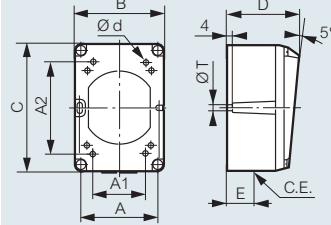

A1 and A2 : optional blind fixing points
Metal boxes are equipped with :
- 2 internal linked earth terminals
- 1 external earth terminal
- 1 tulip earth pin connection between base and cover

LV 32 A (p. 176)

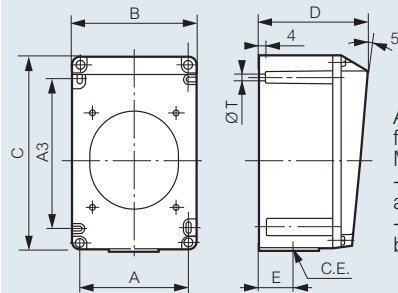

A1 and A2 : optional blind fixing points
Metal boxes are equipped with :
- 2 internal linked earth terminals
- 1 external earth terminal
- 1 tulip earth pin connection between base and cover

Back boxes → Panel mounting sockets ↓	Material	Weight (kg)	Fixings (mm)						Dimensions (mm)					C.E.
			A1	A2	Ød	A	A3	ØT	B	C	D	E		
ELV 16 A/32 A														
2 P	Plastic	0-115	51	68	4-2	64	-	5-3	74	106	58	20	M25	
LV 16 A														
2 P + ⊥	Plastic	0-115	51	68	4-2	64	-	5-3	74	106	58	20	M20	
	Metal	0-520	68	68	4-2	85	-	5-3	96	122	60	22	M20	
3 P + ⊥	Plastic	0-160	68	68	4-2	85	-	5-3	96	122	60	22	M20	
	Metal	0-520												
3 P + N + ⊥	Plastic	0-160	68	68	4-2	85	-	5-3	96	122	60	22	M20	
	Metal	0-520												
LV 32 A														
2 P + ⊥	Plastic	0-340	-	-	-	90	125	5-3	102	162	90	26	M25	
	Metal	0-910												
3 P + ⊥	Plastic	0-340	-	-	-	90	125	5-3	102	162	90	26	M25	
	Metal	0-910												
3 P + N + ⊥	Plastic	0-340	-	-	-	90	125	5-3	102	162	90	26	M25	
	Metal	0-910												

Hypra® IP 44 - LV 16/32 A

through entry surface mounting boxes

■ Technical information

IK 09 (plastic), IK 10 (metal) according to BS EN 62262 and IEC 62262
 Contacts : nickel plated brass with stainless steel connection pins

■ Dimensions

Reversible boxes for surface mounting

LV 16 to 32 A (p. 175-176)

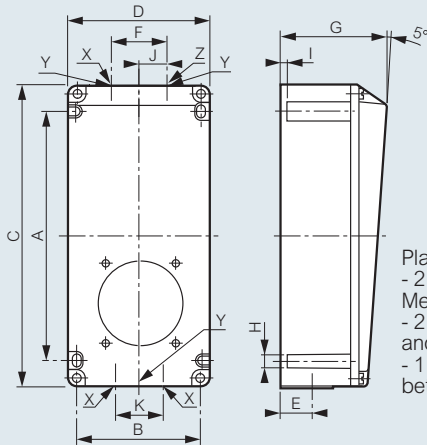

Back boxes → Panel mounting sockets ↓	Material	Weight (kg)	Fixings (mm)			Dimensions (mm)												
			A	B	H	C	D	E	F	G	I	J	K	X	Y	Z		
16 A																		
2 P + ⊕	Plastic	0-330	145	74	5-3	182	86	22	34	75	4	-	-	-	M20	-		
3 P + ⊕	Plastic	0-330	145	74	5-3	182	86	22	34	75	4	-	-	-	M20	-		
	Metal	0-830																
3 P + N + ⊕	Plastic	0-330	145	74	5-3	182	86	22	34	75	4	-	-	-	M20	-		
	Metal	0-830																
	32 A																	
2 P + ⊕	Plastic	0-670	234	117	5-3	270	130	30	50	110	4	-	-	-	M25	-		
	Metal	1-730																
3 P + ⊕	Plastic	0-670	234	117	5-3	270	130	30	50	110	4	-	-	-	M25	-		
	Metal	1-730																
3 P + N + ⊕	Plastic	0-670	234	117	5-3	270	130	30	50	110	4	-	-	-	M25	-		
	Metal	1-730																

Note : Through entry boxes provide extra wiring space but not looping terminals

Hypra® IP 44 - LV 63 A

pilot pin connection

■ Example of 63 A 3 P + ⊕ and 3 P + N + ⊕ pilot pin connection

The pilot pin enables the load to be removed prior to the separation of the phase pins, when the circuit is routed via a contactor

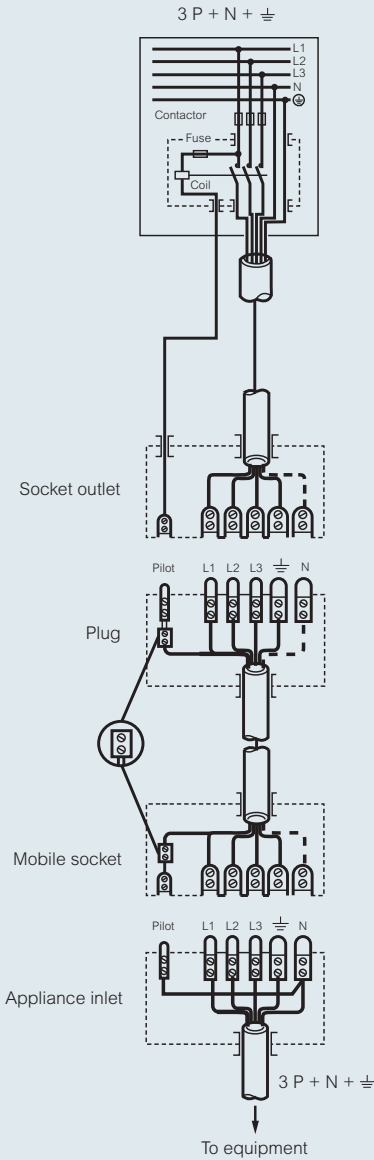

The pilot pin connection accepts 2.5-6 mm² flexible or up to 10 mm² rigid conductor. It is the small centre pin in the connection

■ Pilot cabling

	63 A	Conductors type
Plugs and mobile sockets	2-5 to 6	Flexible
Surface and panel mounting sockets	2-5 to 10	Rigid

Hypra® plugs and sockets IP 66/67-55 - LV 16/32/63/125 A

selection chart

IP 66/67-55 - LV 16, 32, 63 AND 125 A

Conform to :
BS EN 60309-1, BS EN 60309-2,
IEC 60309-1 and IEC 60309-2
IP according to BS EN 60529
and IEC 60529
IK 09
 Self-extinguishing :
 850 °C for insulated parts
 650 °C for housing
 Stainless steel external screws
 Temp. rating : -50 °C to +100 °C
 63/125 A units have a pilot pin



Technical information
 and dimensions
 (p. 183-185)

Straight plugs

Angled plugs

Mobile sockets

Surface
 mounting
 sockets⁽¹⁾

Through entry
 surface mounting
 sockets

Panel mounting sockets

inclined outlets

modular⁽¹⁾ with single
 fixing centres

LV

100 to 130 V 50/60 Hz	16 A	2P + ⊥	0511 55	–	0511 75	0511 25 + 0520 29	0511 25 + 0520 89	0511 25	–
200 to 250 V 50/60 Hz	16 A	2P + ⊥	0511 56	0511 06	0511 76	0511 26 + 0520 29	0511 26 + 0520 89	0511 26	0511 46
	32 A	2P + ⊥	0530 56	0530 06	0530 76	0530 46 + 0529 40	0530 46 + 0529 90	–	0530 46
380 to 415 V 50/60 Hz	16 A	3P + ⊥	0511 60	0511 10	0511 80	0511 30 + 0522 29	0511 30 + 0522 89	0511 30	0511 50
		3P + N + ⊥	0511 61	0511 11	0511 81	0511 31 + 0522 29	0511 31 + 0522 89	0511 31	0511 51
	32 A	3P + ⊥	0530 60	0530 10	0530 80	0530 50 + 0529 40	0530 50 + 0529 90	–	0530 50
		3P + N + ⊥	0530 61	0530 11	0530 81	0530 51 + 0529 40	0530 51 + 0529 90	–	0530 51
380 to 415 V 50/60 Hz	63 A	3P + ⊥	0594 47	–	0594 87	0594 37	–	0594 27	–
		3P + N + ⊥	0594 48	–	0594 88	0594 38	–	0594 28	–
	125 A	3P + ⊥	0595 22	–	0595 32	0595 02	–	0595 12	–
		3P + N + ⊥	0595 23	–	0595 33	0595 03	–	0595 13	–

(1) 70 x 70 mm fixing centres

Complete range from 16 A to 125 A : IP 55 (minimum) guaranteed

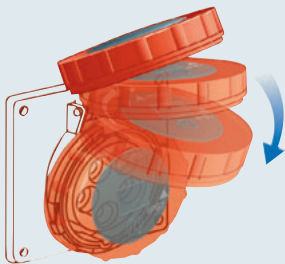

IP 55 assured automatically with cover
 flap down without locking ring secured

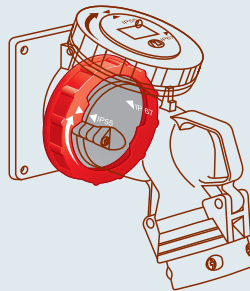

IP 55 guaranteed with IP 66/67-55
 plug inserted and cover in place
 over spigot on plug

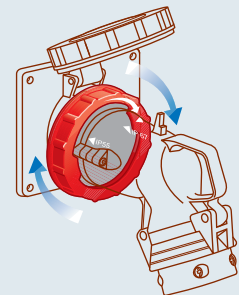

IP 66/67-55 obtained with
 locking ring secured

For voltages/arrangements not listed in this table, please contact us on +44 (0) 845 605 4333

For pack quantities, p. 181-182



Modular sockets have
 70 x 70 mm fixing centres
 across 16 A and 32 A range

see p. 184

Hypra® IP 66/67-55 - LV 16 A

plastic plugs and sockets



0511 61



0511 11



0511 81



0511 30 + 0522 29



0511 30 + 0522 89



Technical information and dimensions (p. 183-185)
Conformity to International Standards (p. 204)

Conform to BS EN 60309-1, BS EN 60309-2, IEC 60309-1 and IEC 60309-2

IP according to BS EN 60529 and IEC 60529

IK 09

Self-extinguishing : 850 °C for insulated parts, 650 °C for housing

Stainless steel external screws - Nickel plated brass contacts

Temp. rating : -50 °C to +100 °C

Pack	Cat. Nos.	Straight plugs 16 A	
1	0511 55	100 to 130 V~ 2 P + ⊥	
1	0511 56	200 to 250 V~ 2 P + ⊥	
5	0511 60	380 to 415 V~ 3 P + ⊥	
5	0511 61	3 P + N + ⊥	

Pack	Cat. Nos.	Angled plugs 16 A	
1	0511 06	100 to 130 V~ 2 P + ⊥	
1	0511 10	380 to 415 V~ 3 P + ⊥	
1	0511 11	3 P + N + ⊥	

Pack	Cat. Nos.	Mobile sockets 16 A	
1	0511 75	100 to 130 V~ 2 P + ⊥	
1	0511 76	200 to 250 V~ 2 P + ⊥	
1	0511 80	380 to 415 V~ 3 P + ⊥	
1	0511 81	3 P + N + ⊥	

Pack	Cat. Nos.		Panel mounting sockets 16 A	
1	Plastic	Modular	100 to 130 V~ 2 P + ⊥	
5/1	0511 26	0511 46	200 to 250 V~ 2 P + ⊥	
1	0511 30	0511 50	380 to 415 V~ 3 P + ⊥	
1	0511 31	0511 51	3 P + N + ⊥	

Pack	Cat. Nos.	Back boxes	
5	0520 29	Surface mounting boxes	
5	0522 29	For LV 16 A 2 P + ⊥ sockets For LV 16 A 3 P + ⊥ / 3 P + N + ⊥ sockets	
1	0520 89	Through entry surface mounting boxes	
5	0522 89	For LV 16 A 2 P + ⊥ sockets For LV 16 A 3 P + ⊥ / 3 P + N + ⊥ sockets	

Hypra® IP 66/67-55 - LV 32 A

plastic plugs and sockets



0530 50 + 0529 40

Technical information and dimensions (p. 183-185)
Conformity to International Standards (p. 204)

Conform to BS EN 60309-1, BS 60309-2, IEC 60309-1 and IEC 60309-2
 IP according to BS EN 60529 and IEC 60529

IK 09
 Self-extinguishing : 850 °C for insulated parts, 650 °C for housing
 Stainless steel external screws - Nickel plated brass contacts
 Temp. rating : -50 °C to +100 °C

Pack Cat. Nos. Straight plugs 32 A

Pack	Cat. Nos.	Configuration	Voltage
1	0530 56	2 P + \perp	100 to 130 V~
1	0530 60	3 P + \perp	380 to 415 V~
1	0530 61	3 P + N + \perp	380 to 415 V~

Pack Cat. Nos. Angled plugs 32 A

Pack	Cat. Nos.	Configuration	Voltage
1	0530 06	2 P + \perp	100 to 130 V~
1	0530 10	3 P + \perp	380 to 415 V~
1	0530 11	3 P + N + \perp	380 to 415 V~

Pack Cat. Nos. Mobile sockets 32 A

Pack	Cat. Nos.	Configuration	Voltage
1	0530 76	2 P + \perp	100 to 130 V~
1	0530 80	3 P + \perp	380 to 415 V~
1	0530 81	3 P + N + \perp	380 to 415 V~

Pack Cat. Nos. Panel mounting sockets (modular) 32 A

Pack	Cat. Nos.	Configuration	Voltage
1	Modular 0530 46	2 P + \perp	100 to 130 V~
1	0530 50	3 P + \perp	380 to 415 V~
1	0530 51	3 P + N + \perp	380 to 415 V~

Back boxes

Pack	Cat. Nos.	Description
1	0529 40	Surface mounting boxes For LV 32 A 2 P + \perp / 3 P + \perp / 3 P + N + \perp sockets
5	0529 90	Through entry surface mounting boxes For LV 32 A 2 P + \perp / 3 P + \perp / 3 P + N + \perp sockets

Hypra® IP 66/67-55 - LV 63 and 125 A

plastic plugs and sockets

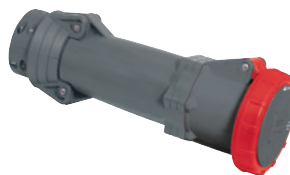

0595 32



0594 27

Technical information and dimensions (p. 183-185)

Conform to BS EN 60309-1, BS 60309-2, IEC 60309-1 and IEC 60309-2
 IP according to BS EN 60529 and IEC 60529

IK 09
 Self-extinguishing : 850 °C for insulated parts, 650 °C for housing
 Stainless steel external screws - Nickel plated brass contacts
 Temp. rating : -50 °C to +100 °C
 LV 63 A and 125 A have a pilot pin

Pack Cat. Nos. Straight plugs 63 and 125 A

Pack	Cat. Nos.	Configuration	Voltage
1	63 A 125 A 0594 47 0595 22	3 P + \perp	380 to 415 V~
1	0594 48 0595 23	3 P + N + \perp	380 to 415 V~

Pack Cat. Nos. Mobile sockets 63 and 125 A

Pack	Cat. Nos.	Configuration	Voltage
1	63 A 125 A 0594 87 0595 32	3 P + \perp	380 to 415 V~
1	0594 88 0595 33	3 P + N + \perp	380 to 415 V~

Pack Cat. Nos. Surface mounting sockets 63 and 125 A

Pack	Cat. Nos.	Configuration	Voltage
1	63 A 125 A 0594 37 0595 02	3 P + \perp	380 to 415 V~
1	0594 38 0595 03	3 P + N + \perp	380 to 415 V~

Pack Cat. Nos. Panel mounting sockets 63 and 125 A

Pack	Cat. Nos.	Configuration	Voltage
1	63 A 125 A 0594 27 0595 12	3 P + \perp	380 to 415 V~
1	0594 28 0595 13	3 P + N + \perp	380 to 415 V~

Hypra® IP 66/67-55 - LV 16/32/63/125 A

plastic plugs and sockets

■ Technical information

IP 66/67-55 conforms to BS EN 60529 and IEC 60529
 Icc 10 kA according to BS EN 60309-1 and IEC 60309-1
 Stainless steel external screws - Nickel plated brass contacts
 IK according to BS EN 62262 and IEC 62262 : plastic = IK 09

■ Wiring tested according to BS EN 60309-1

Type	Current	Conductors size (mm ²)	Conductors type
Plugs and mobile sockets	LV 16 A	1 to 2.5	Flexible
	LV 32 A	2.5 to 6	Flexible
	LV 63 A	6 to 16	Flexible
	LV 125 A	16 to 50	Flexible
Panel and surface mounting sockets	LV 16 A	1.5 to 4	Rigid
	LV 32 A	2.5 to 10	Rigid
	LV 63 A	6 to 25	Rigid
	LV 125 A	25 to 70	Rigid

Tightening torque of connection screws

LV 16 A : from 0.7 to 1 Nm
 LV 32 A : from 0.7 to 1 Nm
 LV 63 A : from 2 to 2.2 Nm for Phase and Earth
 from 0.7 to 1 Nm for pilot
 LV 125 A : from 3 to 4 Nm for Phase and Earth
 from 0.7 to 1 Nm for pilot

■ Dimensions

Straight plugs IP 66/67-55

LV 16/32 A (p. 181-182)

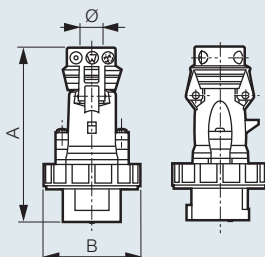

	Weight (kg)	A (mm)	B (mm)	Ø Clamping and grip (mm)
LV 16 A				
2 P + ⊥	0.165	135	72.5	8 to 15
3 P + ⊥	0.195	139	81	8 to 15
3 P + N + ⊥	0.220	154	86.5	10 to 18
LV 32 A				
2 P + ⊥	0.280	164	94.5	10 to 18
3 P + ⊥	0.280	164	94.5	12 to 22
3 P + N + ⊥	0.325	170	101	12 to 22

LV 63 A (p. 182)

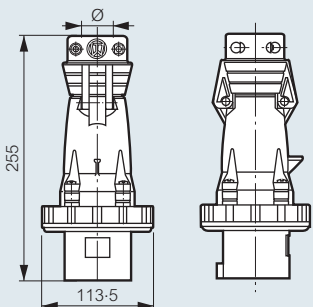

	Weight (kg)	Ø Clamping and grip (mm)
LV 63 A		
3 P + ⊥	0.680	18.5 to 29
3 P + N + ⊥	0.750	20.5 to 32

LV 125 A (p. 182)

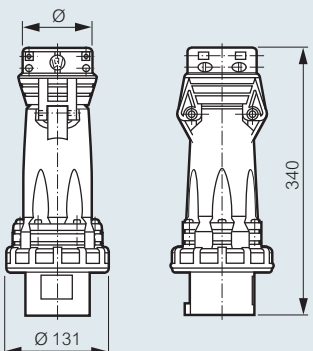

	Weight (kg)	Ø Clamping and grip (mm)
LV 125 A		
3 P + ⊥	1.54	24 to 48
3 P + N + ⊥	1.7	28 to 48

■ Dimensions (continued)

Angled plugs IP 66/67-55

LV 16/32 A (p. 181-182)

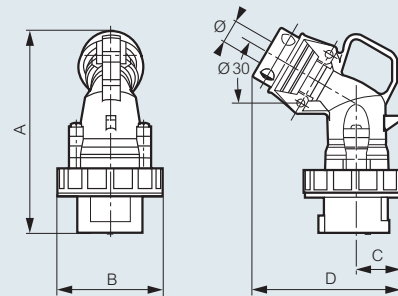

	Weight (kg)	Dimensions (mm)				Ø Clamping and grip (mm)
		A	B	C	D	
LV 16 A						
2 P + ⊥	0.165	136	72.5	29.5	100	8 to 15
3 P + ⊥	0.195	141	81	33.5	105	8 to 15
3 P + N + ⊥	0.220	150	86.5	37.5	114	10 to 18
LV 32 A						
2 P + ⊥	0.280	161	94.5	39.5	116	10 to 18
3 P + ⊥	0.280	161	94.5	39.5	116	12 to 22
3 P + N + ⊥	0.325	167	101	44.5	122	12 to 22

Mobile sockets IP 66/67-55

LV 16/32 A (p. 181-182)

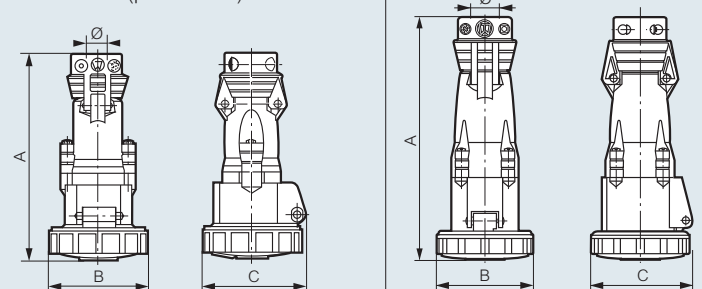

	Material	Weight (kg)	Dimensions (mm)			Ø Clamping and grip (mm)
			A	B	C	
LV 16 A						
2 P + ⊥	Plastic	0.180	150	72.5	75.5	8 to 15
3 P + ⊥	Plastic	0.215	154	81	86	8 to 15
3 P + N + ⊥	Plastic	0.275	189	86.5	89	10 to 18
LV 32 A						
2 P + ⊥	Plastic	0.320	179	94.5	99	10 to 18
3 P + ⊥	Plastic	0.320	179	94.5	99	12 to 22
3 P + N + ⊥	Plastic	0.375	185	101	106	12 to 22
LV 63 A						
3 P + ⊥	Plastic	0.850	278	113.5	119	18.5 to 29
3 P + N + ⊥	Plastic	0.910	278	113.5	119	20.5 to 32

LV 125 A⁽¹⁾ (p. 182)

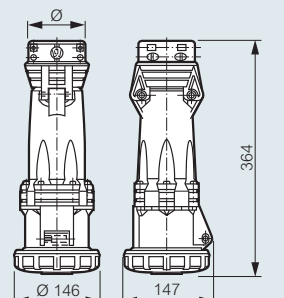

	Weight (kg)	Ø Clamping and grip (mm)
LV 125 A		
3 P + ⊥	1.8	24 to 48
3 P + N + ⊥	2.0	28 to 48

(1) Wiring diagram for 63 A and 125 A shown on p. 185

Hypra® IP 66/67-55 - LV 16/32/63/125 A

plastic plugs and sockets (continued)

■ Dimensions (continued)

Panel mounting sockets IP 66/67-55

LV 16 A (p. 181)

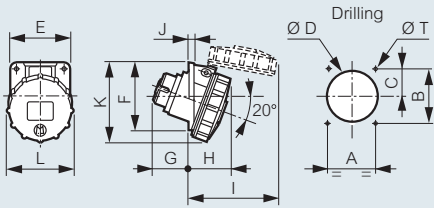

	Weight (kg)	Drilling (mm)			Dimensions (mm)									
		A	B	C	ØD	ØT	E	F	G	H	I	J	K	L
LV 16 A														
2 P+ ±	0.140	52	60	33	55	4.2	64	72	40	45	91	5.5	87	72.5
3 P+ ±	0.165	60	70	39	63.5	5.2	74	84	41	48	102	5.5	96	81
3 P+N+ ±	0.195	60	70	37	70.6	5.2	80	84	42	50	106	5.5	96	86.5

LV 16/32 A with modular fixings (p. 181-182)

Single fixing centres

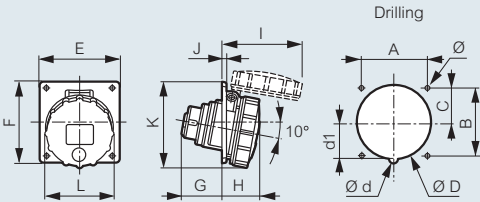

	Weight (kg)	Drilling (mm)			Dimensions (mm)											
		A	B	C	ØD	Ød	d1	E	F	G	H	I	J	K	L	Ø
LV 16 A																
2 P+ ±	0.140	70	70	35	76.2	-	-	84	84	42	39	83	4.5	90	72.5	4.2
3 P+ ±	0.165	70	70	35	76.2	-	-	84	84	43	41	98	4.5	93	81	4.2
3 P+N+ ±	0.195	70	70	35	76.2	-	-	84	84	43	41	99	4.5	91	86.5	4.2
LV 32 A																
2 P+ ±	0.240	70	70	35	76.2	-	-	84	94	54	50	113	4.5	101	94.5	4.2
3 P+ ±	0.240	70	70	35	76.2	-	-	84	94	54	50	113	4.5	101	94.5	4.2
3 P+N+ ±	0.270	70	70	35	76.2	8	36	84	94	54	51	120	4.5	103	101	4.2

LV 63/125 A (p. 182)

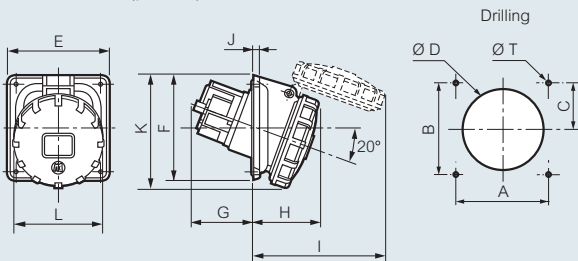

	Weight (kg)	Drilling (mm)			Dimensions (mm)									
		A	B	C	ØD	ØT	E	F	G	H	I	J	K	L
LV 63 A														
3 P+ ±	0.71	77	85	42.5	92	6.5	106	106	98	79	158	6	127	113.5
3 P+N+ ±	0.77	77	85	42.5	92	6.5	106	106	98	79	158	6	127	113.5
LV 125 A														
3 P+ ±	1.40	124	124	62	120	6.5	146	146	84	93	182	8	157	131
3 P+N+ ±	1.55	124	124	62	120	6.5	146	146	84	93	182	8	157	131

■ Dimensions (continued)

Surface mounting sockets IP 66/67-55

LV 63 A (p. 182)

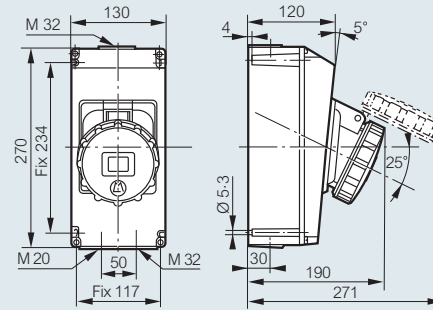

	Weight (kg)
LV 63 A	
3 P+ ±	1.65
3 P+N+ ±	1.70

LV 125 A (p. 182)

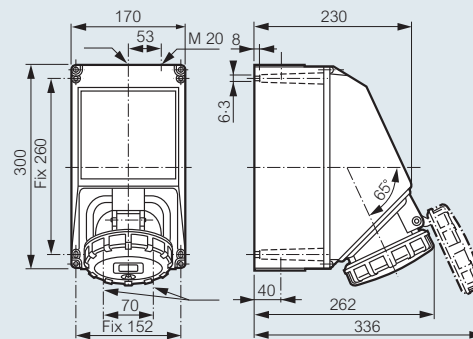

	Weight (kg)
LV 125 A	
3 P+ ±	3.5
3 P+N+ ±	3.7

Hypra® IP 66/67-55 - LV 16/32/63 A

surface mounting and through entry back boxes

Hypra® IP 66/67-55 - LV 63 and 125 A

pilot pin connection

■ Dimensions

Surface mounting boxes

Reversible boxes for surface mounting sockets
Boxes can be rotated to aid entry

LV 16 A (p. 181)

LV 32 A (p. 182)

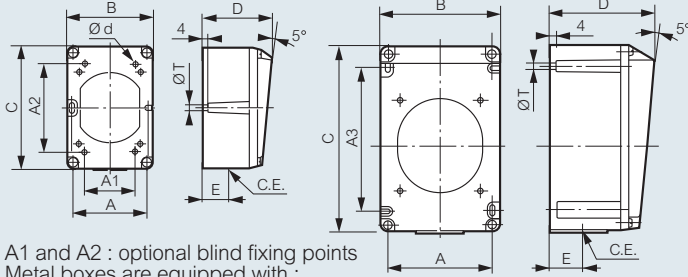

A1 and A2 : optional blind fixing points
Metal boxes are equipped with :
- 2 internal linked earth terminals and 1 external earth terminal
- 1 tulip earth pin connection between base and cover

Back boxes → Panel mounting sockets ↓	Material	Weight (kg)	Fixings (mm)					Dimensions (mm)					C.E.
			A1	A2	ød	A	A3	ØT	B	C	D	E	
LV 16 A													
2 P + ⊕	Plastic	0.115	51	68	4.2	64	-	5.3	74	106	58	20	M20
3 P + ⊕	Plastic	0.160	68	68	4.2	85	-	5.3	96	122	60	22	M20
3 P + N + ⊕	Plastic	0.160	68	68	4.2	85	-	5.3	96	122	60	22	M20
LV 32 A													
2 P + ⊕ / 3 P + ⊕	Plastic	0.340	-	-	-	90	125	5.3	102	162	90	26	M25
3 P + N + ⊕													

Through entry surface mounting boxes

Reversible boxes for surface mounting through entry sockets

LV 16 to 63 A (p. 181-182)

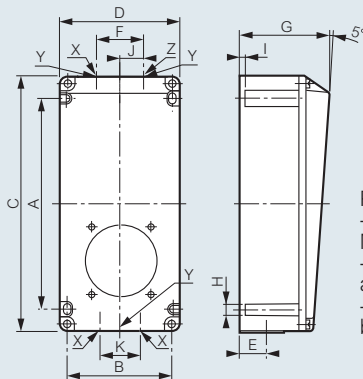

Plastic box equipped with :
- 2 internal linked earth terminals
Metal box equipped with :
- 2 internal linked earth terminals
and 1 external earth terminal
- 1 tulip earth pin connection
between base and cover

Back boxes → Panel mounting sockets ↓	Material	Weight (kg)	Fixings (mm)					Dimensions (mm)										
			A	B	H	C	D	E	F	G	I	J	K	X	Y	Z		
16 A																		
2 P + ⊕	Plastic	0.330	145	74	5.3	182	86	22	34	75	4	-	-	-	M20	-		
3 P + ⊕	Plastic	0.330	145	74	5.3	182	86	22	34	75	4	-	-	-	M20	-		
3 P + N + ⊕	Plastic	0.330	145	74	5.3	182	86	22	34	75	4	-	-	-	M20	-		
32 A																		
2 P + ⊕	Plastic	0.670	234	117	5.3	270	130	30	50	110	4	-	-	-	M25	-		
3 P + ⊕	Plastic	0.670	234	117	5.3	270	130	30	50	110	4	-	-	-	M25	-		
3 P + N + ⊕	Plastic	0.670	234	117	5.3	270	130	30	50	110	4	-	-	-	M25	-		
63 A																		
3 P + ⊕	Plastic	2.000	260	152	6.3	300	170	40	-	150	8	50	70	M32	-	M20		
3 P + N + ⊕	Plastic	2.000	260	152	6.3	300	170	40	-	150	8	50	70	M32	-	M20		

Note : Through entry boxes provide extra wiring space but not looping terminals

■ Example of 63/125 A 3 P + ⊕ and 3 P + N + ⊕ pilot pin connection

The pilot pin enables the load to be removed prior to the separation of the phase pins, when the circuit is routed via a contactor

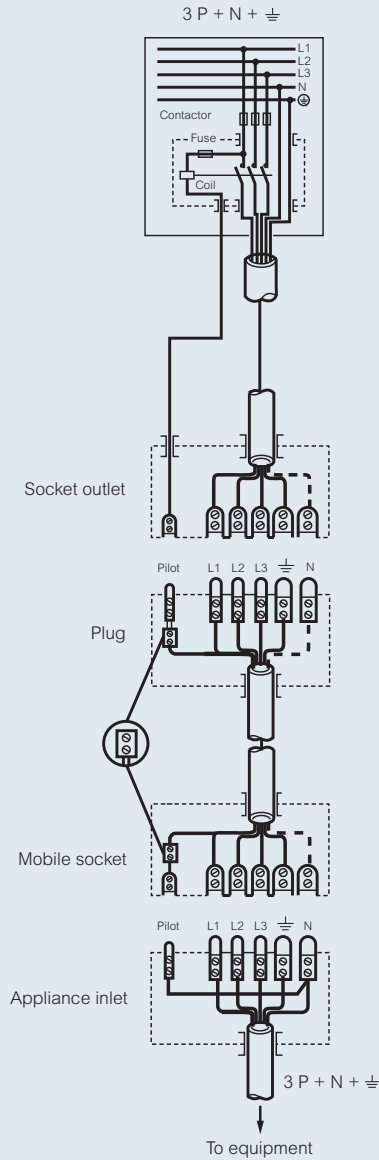

The pilot pin connection accepts 2.5-6 mm² flexible or up to 10 mm² rigid conductor. It is the small centre pin in the connection

■ Pilot cabling

	63 A	Conductors type
Plugs and mobile sockets	2.5 to 6	Flexible
Surface and panel mounting sockets	2.5 to 10	Rigid

P17 Tempra® plugs and sockets...

simplicity, innovation and value



P17 Tempra represents the best in value and is ideally suited for applications where power requirements can change from day-to-day, including building sites and other temporary locations.

Packed with features which are designed to save assembly time, the range is available in IP44 and IP66/67 IK09 rated formats, ranging from plugs and mobile sockets to surface mounted sockets and appliance inlets.

Innovative design

The two part plugs and mobile sockets feature a simple twist-lock action that reduces assembly time by incorporating a membrane gland entry with screwless cable clamp.

FEATURES:

- **Products supplied in the open position** - ready to assemble
- **Single orientation of connection screws** - for rapid assembly
- **Automatic sealing of cable entry (mobile products)** - instant IP44 protection
- **Screwless cable clamp and membrane** - flexible cable entry and IP44 protection
- **Snap fitting covers on panel mounting products** - for speed and simplicity

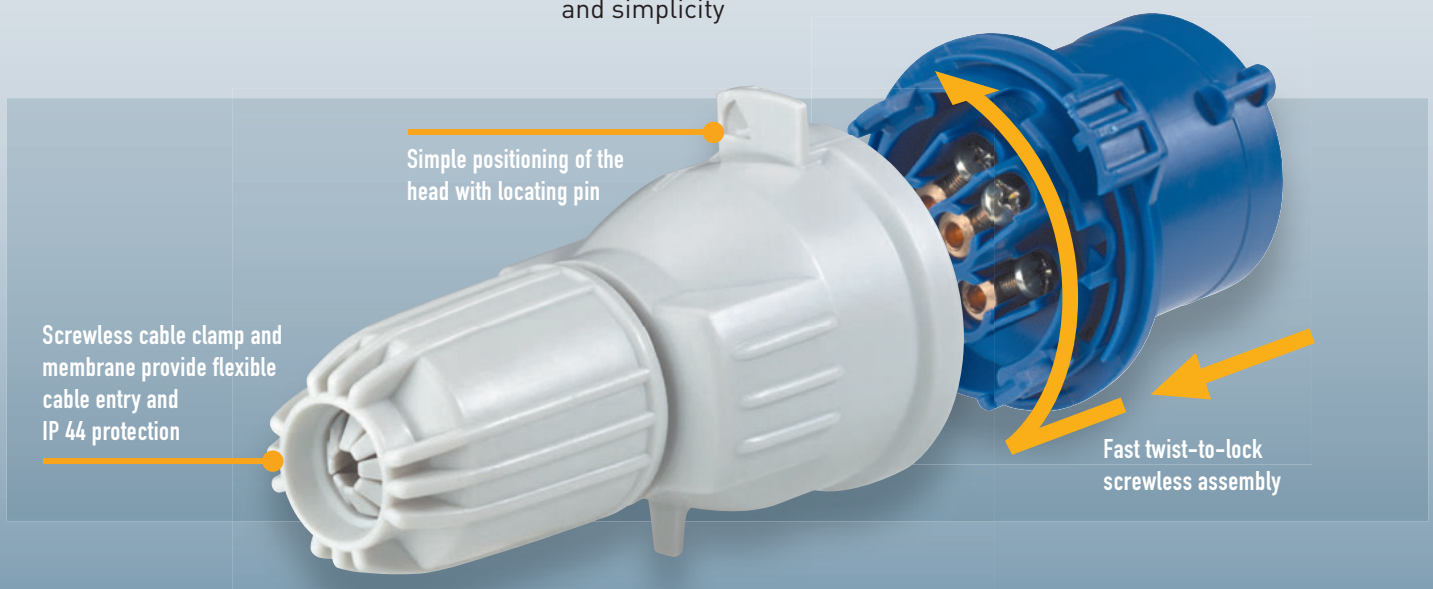

P17 TEMPRA PLUGS AND SOCKETS – options for every application

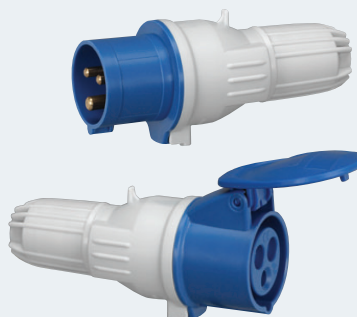

Plugs and mobile sockets

CURRENT RATING – 16A, 32A, 63A
VOLTAGES – 110V, 240V, 400V
PIN CONFIG – 2P+E, 3P+E, 3P+N+E
IP RATINGS – IP44, IP66/67



Socket outlets

CURRENT RATING – 16A, 32A, 63A
VOLTAGES – 110V, 240V, 400V
PIN CONFIG – 2P+E, 3P+E, 3P+N+E
IP RATINGS – IP44, IP66/67



Appliance inlets

CURRENT RATING – 16A, 32A, 63A
VOLTAGES – 110V, 240V, 400V
PIN CONFIG – 2P+E, 3P+E, 3P+N+E
IP RATING – IP44

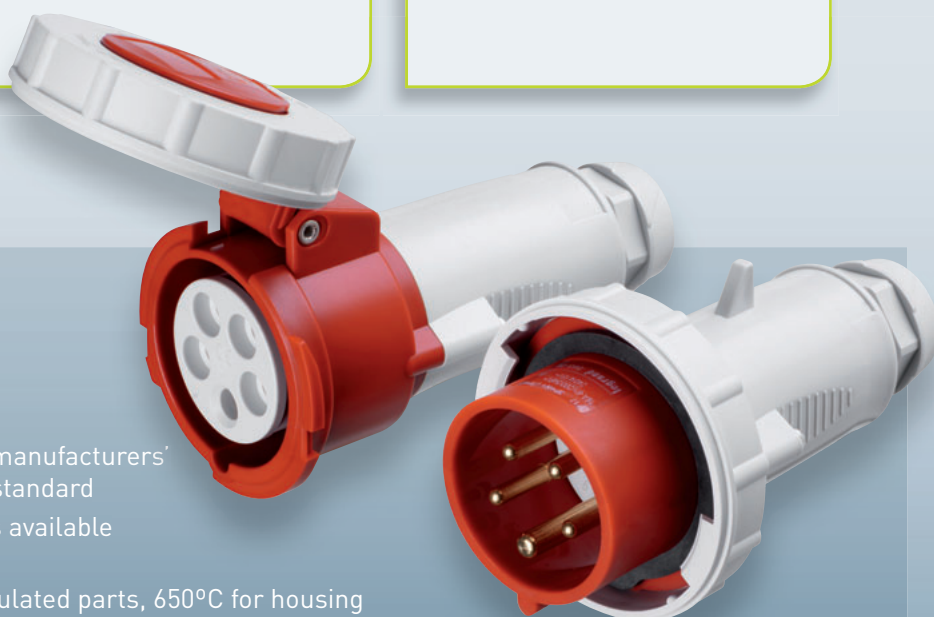

TECHNICAL DATA

APPROVALS: BS EN 60309-1
 BS EN 60309-2
 BS EN 60529 (IP)
 BS EN 62262 (IK)

Products are interchangeable with other manufacturers' products which meet the BS EN 60309-2 standard

PROTECTION: IP44 and IP66/67 ranges available
 IK09

SELF EXTINGUISHING: 850°C for insulated parts, 650°C for housing

OPERATING TEMPERATURE: -25°C to +40°C

P 17 Tempra® plugs and sockets IP 44 and IP 66/67 - LV 16/32/63 A

selection chart

IP 44 - LV 16/32 A

Conform to : BS EN 60309-1,
BS EN 60309-2, IEC 60309-1
and IEC 60309-2
IK 08/IK 09

Self-extinguishing :
850 °C for insulated parts
(650 °C for housing and cover)
Temp. rating : -25 °C to +40 °C



Technical information
and dimensions
(p. 190-191)



**Straight
plugs**



**Mobile
sockets**



**Appliance
inlets⁽²⁾**



**Surface
mounting
sockets⁽¹⁾**



**Surface
mounting
sockets
inclined**



**Panel mounting sockets
Inclined
modular⁽¹⁾**



**Straight
small flange**

LV

100 to 130 V 50/60 Hz	16 A	2 P + ⊥	0574 31	0575 11	0575 81	0553 50	0555 50	0576 10	0573 51
	32 A	2 P + ⊥	0581 21	0582 01	–	–	–	0576 08	–
200 to 250 V 50/60 Hz	16 A	2 P + ⊥	0574 34	0575 14	0575 84	0553 53	0555 53	0576 11	0573 54
	32 A	2 P + ⊥	0581 34	0582 14	0582 84	0553 73	0555 73	0576 12	0580 54
380 to 415 V 50/60 Hz	16 A	3 P + ⊥	0574 38	0575 18	0575 88	0553 57	0555 57	0576 17	0573 58
		3 P + N + ⊥	0574 39	0575 19	0575 89	0553 58	0555 58	0576 23	0573 59
	32 A	3 P + ⊥	0581 38	0582 18	–	–	–	0576 18	–
		3 P + N + ⊥	0581 39	0582 19	0582 89	0553 78	0555 78	0576 24	0580 59

IP 66/67 - LV 16/32/63 A

Conform to : BS EN 60309-1,
BS EN 60309-2, IEC 60309-1
and IEC 60309-2
IK 09

Self-extinguishing :
850 °C for insulated parts
(650 °C for housing and cover)
Temp. rating : -25 °C to +40 °C
63 A units have a pilot pin



Technical information
and dimensions
(p. 193)



**Straight
plugs**



**Mobile
sockets**



**Surface
mounting
sockets**

Adaptor

Conform to BS EN 60309-1,
BS EN 60309-2, IEC 60309-1
and IEC 60309-2

Self-extinguishing : 850 °C
Temp. rating : -15 °C to +40 °C



Dimensions
(p. 190)

16 A – 230 V

	Pack	Cat. No.
IEC 2 P + ⊥ plug – 13 A 2 P + ⊥ B.S. socket	10	0521 01

LV					
200 to 250 V 50/60 Hz	16 A	2 P + ⊥	0563 03	0562 03	0553 03
	32 A	2 P + ⊥	0563 23	0562 23	0553 23
	63 A	2 P + ⊥	0587 00	0587 10	0587 40
380 to 415 V 50/60 Hz	16 A	3 P + ⊥	0563 07	0562 07	0553 07
		3 P + N + ⊥	0563 08	0562 08	0553 08
	32 A	3 P + ⊥	0563 27	0562 27	0553 27
		3 P + N + ⊥	0563 28	0562 28	0553 28
	63 A	3 P + ⊥	0587 04	0587 14	0587 44
		3 P + N + ⊥	0587 05	0587 15	0587 45



**Modular sockets
have 70 x 70 mm
fixing centres across
16 A and 32 A range**

see p. 189

For 125 A rated please see Hypra p. 182

For voltages/arrangements not listed in this table, please contact us on +44 (0) 845 605 4333

(1) 70 x 70 mm fixing centres (modular) (2) Appliance inlet covers, see p. 174

For pack quantities, see p. 189 and 192

P 17 Tempra® IP 44 - LV 16 and 32 A

plastic plugs and sockets



0574 34



0575 14



0575 84



0553 53



0555 53



0576 11



0573 54

Technical information and dimensions (p. 190-191)
Conformity to International Standards (p. 204)

Conform to BS EN 60309-1, BS EN 60309-2, IEC 60309-1 and IEC 60309-2
 IP 44
 IK 08 (surface mounting sockets)
 IK 09 (straight plugs, mobile sockets, panel mounting sockets and appliance inlets)
 Self-extinguishing : 850 °C for insulated parts (650 °C for housing and cover)
 Temp. rating : -25 °C to +40 °C

Pack	Cat. Nos.		Straight plugs 16 and 32 A	
1/5	16 A	32 A	100 to 130 V~	
	0574 31	0581 21	200 to 250 V~	
1	0574 34		380 to 415 V~	
		0581 34	100 to 130 V~	
1	0574 38	0581 38	200 to 250 V~	
1	0574 39	0581 39	380 to 415 V~	

Pack	Cat. Nos.		Mobile sockets 16 and 32 A	
1/5	16 A	32 A	100 to 130 V~	
	0575 11	0582 01	200 to 250 V~	
1	0575 14		380 to 415 V~	
		0582 14	100 to 130 V~	
1	0575 18	0582 18	200 to 250 V~	
1	0575 19	0582 19	380 to 415 V~	

Pack	Cat. Nos.		Appliance inlets 16 and 32 A	
5	16 A	32 A	100 to 130 V~	
	0575 81		200 to 250 V~	
5	0575 84		380 to 415 V~	
		0582 84	100 to 130 V~	
5	0575 88		200 to 250 V~	
5	0575 89	0582 89	380 to 415 V~	

For appliance inlet covers see p. 174



**For 125 A rated requirements
see Hypra range**

see p. 182

Pack	Cat. Nos.		Surface mounting sockets 16 and 32 A	
5	16 A	32 A	100 to 130 V~	
	0553 50		200 to 250 V~	
10	0553 53		380 to 415 V~	
		0553 73	100 to 130 V~	
5			200 to 250 V~	
10	0553 57		380 to 415 V~	
10	0553 58	0553 78	100 to 130 V~	

Pack	Cat. Nos.		Surface mounting sockets inclined 16 and 32 A	
1	16 A	32 A	100 to 130 V~	
	0555 50		200 to 250 V~	
1	0555 53		380 to 415 V~	
		0555 73	100 to 130 V~	
1			200 to 250 V~	
1	0555 57		380 to 415 V~	
1	0555 58	0555 78	100 to 130 V~	

Pack	Cat. Nos.		Panel mounting sockets 16 and 32 A inclined modular	
5/1	16 A	32 A	100 to 130 V~	
	0576 10	0576 08	200 to 250 V~	
10	0576 11		380 to 415 V~	
		0576 12	100 to 130 V~	
10			200 to 250 V~	
10	0576 17	0576 18	380 to 415 V~	
10	0576 23	0576 24	100 to 130 V~	

Pack	Cat. Nos.		Panel mounting sockets 16 and 32 A straight small flange	
5	16 A	32 A	100 to 130 V~	
	0573 51		200 to 250 V~	
5	0573 54		380 to 415 V~	
		0580 54	100 to 130 V~	
5			200 to 250 V~	
5	0573 58		380 to 415 V~	
5	0573 59	0580 59	100 to 130 V~	

P 17 Tempra® IP 44 - LV 16 and 32 A

plastic plugs and sockets

■ Technical information

IP 44 conforms to BS EN 60529 and IEC 60529
IK 08/IK 09 conforms to BS EN 62262 and IEC 62262

LV max. terminal capacity 16 A - 1 x 2.5 mm² flexible cable
32 A - 1 x 6 mm² flexible cable

Straight plugs, mobile sockets and surface mounting sockets inclined

Product supplied in open position
Philips No. 2 connection screws (cross-head slotted zinc-plated steel)
Single orientation of connection screws

Mobile sockets only

Screwless product closing by quarter turn
Integral cable gland with fixing claw
Automatic sealing on cable entry
Cable fixing by simple cable gland clamping
Captive cable gland
Double thread for rapid clamping of cable gland
Number of openings/closings tested : 20

Surface mounting sockets inclined only

Product closing by simple snapfitting of cover onto base or box
Surface mounting base without tapping : 0555 50/53/57/58 - 0555 73/78
Base with closable entry ISO 20/25 on the back
Cover with closable entry ISO 20/25 by the top

■ Connection capacity

Type	Current	Conductors size (mm ²)	Conductors type
Straight plugs and mobile sockets	LV 16 A	1 to 2.5	Flexible
	LV 32 A	2.5 to 6	Flexible
Panel appliance inlets	LV 16 A	1 to 2.5	Rigid
	LV 32 A	2.5 to 6	Rigid
Surface and panel mounting sockets	LV 16 A	1.5 to 4	Rigid
	LV 32 A	2.5 to 10	Rigid

■ Dimensions

Straight plugs IP 44

LV 16/32 A

Design with twist clamp and membrane gland
Screwless body assembly (p. 189)

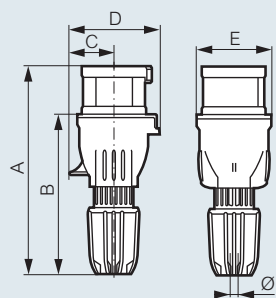

	Weight (kg)	A (mm)	B (mm)	C (mm)	D (mm)	E (mm)	Ø clamping and grip (mm)
LV 16 A							
2P+±	0-122	143 to 159	106 to 122	30	65	56	8 to 14
3P+±	0-150	143 to 159	106 to 122	34	69	56	8 to 14
3P+N+±	0-177	152 to 168	115 to 131	38	78	65	10 to 18
LV 32 A							
2P+±	0-217	161 to 177	115 to 131	39	79	65	10 to 18
3P+±	0-234	161 to 177	115 to 131	39	79	65	12 to 20
3P+N+±	0-276	167 to 181	121 to 135	45	88	72	14 to 21

■ Dimensions (continued)

Mobile sockets IP 44

LV 16/32 A

Design with twist clamp and membrane gland
Screwless body assembly (p. 189)

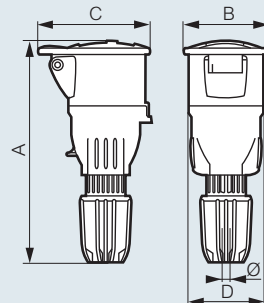

	Weight (kg)	A (mm)	B (mm)	C (mm)	D (mm)	Ø clamping and grip (mm)
LV 16 A						
2P+±	0-150	153 to 169	55	78	56	8 to 14
3P+±	0-179	153 to 169	62	85	56	8 to 14
3P+N+±	0-212	164 to 180	70	94	65	10 to 18
LV 32 A						
2P+±	0-240	174 to 190	71	98	65	10 to 18
3P+±	0-265	174 to 190	71	98	65	12 to 20
3P+N+±	0-305	177 to 191	77	101	72	14 to 21

Appliance inlets IP 44

LV 16/32 A (p. 189)

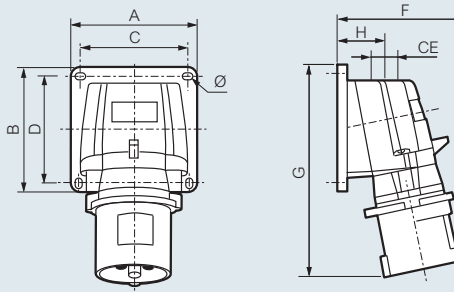

	Weight (kg)	A (mm)	B (mm)	C (mm)	D (mm)	F (mm)	G (mm)	H (mm)	CE (mm)	Ø clamping and grip (mm)
LV 16 A										
2P+±	0-168	84	84	72	72	77	126	34	M20	4-3
3P+±	0-232	84	84	72	72	84	134	34	M20	4-3
3P+N+±	0-256	84	84	72	72	91	141	34	M20	4-3
LV 32 A										
3P+N+±	0-364	110	110	98	98	102	168	39	M25	5-3

Adaptor from IEC to BS (p. 188)

Cat. No. 0521 01

16 A 2P+± 230 V plug to 13 A 3 pin BS socket

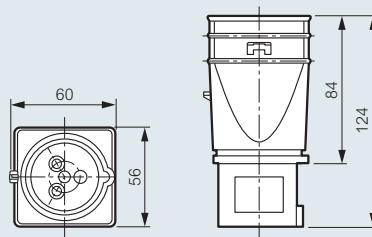

P 17 Tempra® IP 44 - LV 16 and 32 A

plastic plugs and sockets (continued)

■ Dimensions (continued)

Surface mounting sockets IP 44

LV 16/32 A (p. 189)

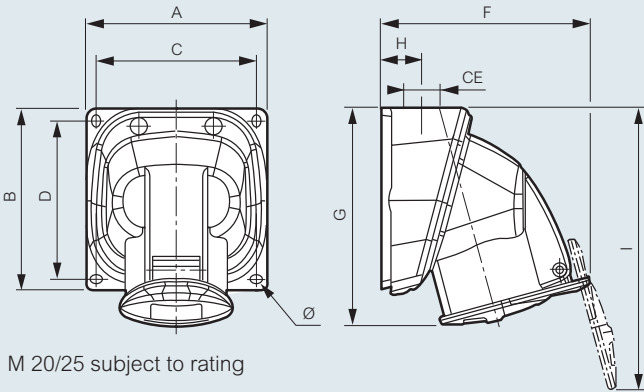

M 20/25 subject to rating

	Weight (kg)	A (mm)	B (mm)	C (mm)	D (mm)	F (mm)	G (mm)	H (mm)	I (mm)	CE (mm)	Ø (mm)
LV 16 A											
2P+±	0-185	84	84	73	72	103	103-5	20	134	M20	4-3
3P+±	0-244	100	100	88	87	115	120	24	156	M20	4-3
3P+N+±	0-269	100	100	88	87	118-5	121	24	162	M20	4-3
LV 32 A											
3P+N+±	0-397	110	110	98	97	137	162-5	30	178	M25	5-3

Surface mounting sockets inclined IP 44

LV 16/32 A (p. 189)

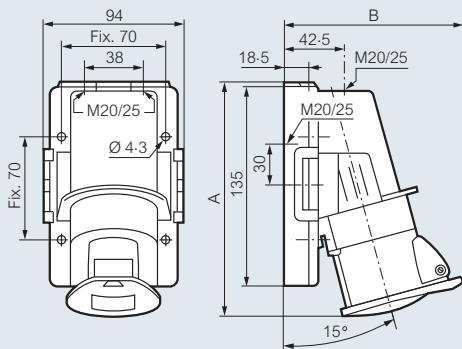

M 20/25 dual knockout entry

	A (mm)	B (mm)
LV 16 A		
2P+±	158	121
3P+±	158	123
3P+N+±	171	130
LV 32 A		
3P+N+±	192	140

■ Dimensions (continued)

Panel mounting sockets IP 44

LV 16/32 A

With modular fixing centres 70 x 70 mm (p. 189)

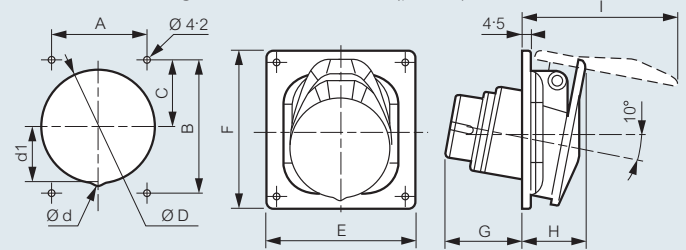

	Weight (kg)	A (mm)	B (mm)	C (mm)	Ø D (mm)	Ø d (mm)	d1 (mm)	E (mm)	F (mm)	G (mm)	H (mm)	I (mm)
LV 16 A												
2P+±	0-110	70	70	35	76-2	-	-	84	84	42	33	83-5
3P+±	0-140	70	70	35	76-2	-	-	84	84	43	34-5	91-3
3P+N+±	0-165	70	70	35	76-2	-	-	84	84	43	36-5	100
LV 32 A												
2P+±	0-220	70	70	35	76-2	-	-	84	94	54	44	112
3P+±	0-255	70	70	35	76-2	8	36	84	94	54	45	120

Straight panel mounting sockets IP 44

LV 16/32 A

Small flange (p. 189)

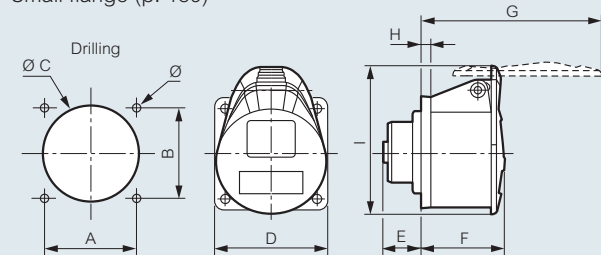

	Weight (kg)	A (mm)	B (mm)	Ø C (mm)	D (mm)	E (mm)	F (mm)	G (mm)	H (mm)	I (mm)	Ø (mm)
LV 16 A											
2P+±	0-105	47	47	47	58	22-4	50	98-5	5-5	78-5	5-5
3P+±	0-127	52	52	55	65	22-4	50-5	104	5-5	85-6	5-5
3P+N+±	0-148	52	52	55	70	22-4	51	113	5-5	93-5	5-5
LV 32 A											
3P+N+±	0-246	60	60	63-5	77	31-4	61-7	134	5-5	104-5	5-5

P 17 Tempra® IP 66/67 - LV 16/32/63 A

plastic plugs and sockets

P 17 Tempra® IP 66/67 - LV 16/32/63 A

plastic plugs and sockets



0563 07



0553 07

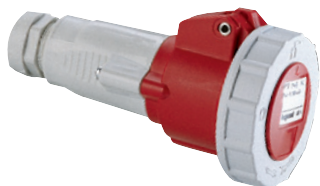

0587 14



Technical information and dimensions (p. 193)
Conformity to International Standards (p. 204)

Conform to BS EN 60309-1, BS EN 60309-2, IEC 60309-1 and IEC 60309-2
IK 09

Self-extinguishing : 850 °C for insulated parts (650 °C for housing and cover)

Temp. rating : -25 °C to +40 °C

63 A units have a pilot pin

Pack	Cat. Nos.		Straight plugs 16/32/63 A	
5	16 A	32 A	200 to 250 V~	
	0563 03	0563 23	380 to 415 V~	
5	0563 07	0563 27	3 P + ⊥	
	0563 08	0563 28	3 P + N + ⊥	
1	63 A		200 to 250 V~	
	0587 00		380 to 415 V~	
1	0587 04		3 P + ⊥	
	0587 05		3 P + N + ⊥	

Pack	Cat. Nos.		Mobile sockets 16/32/63 A	
5	16 A	32 A	200 to 250 V~	
	0562 03	0562 23	380 to 415 V~	
5	0562 07	0562 27	3 P + ⊥	
	0562 08	0562 28	3 P + N + ⊥	
1	63 A		200 to 250 V~	
	0587 10		380 to 415 V~	
1	0587 14		3 P + ⊥	
	0587 15		3 P + N + ⊥	

Pack	Cat. Nos.		Surface mounting sockets 16/32/63 A	
5	16 A	32 A	200 to 250 V~	
	0553 03	0553 23	380 to 415 V~	
5	0553 07	0553 27	3 P + ⊥	
	0553 08	0553 28	3 P + N + ⊥	
1	63 A		200 to 250 V~	
	0587 40		380 to 415 V~	
1	0587 44		3 P + ⊥	
	0587 45		3 P + N + ⊥	

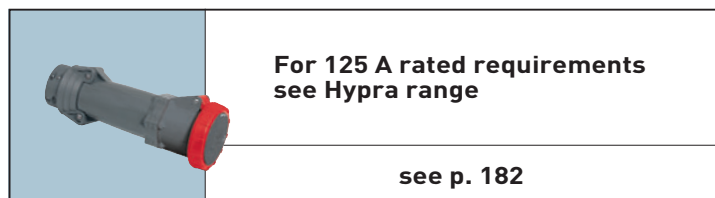

Technical information

IP 66/67 conforms to BS EN 60529 and IEC 60529
IK 09 conforms to BS EN 62262 and IEC 62262

Straight plugs and mobile sockets

Connection via captive screws (16 and 32 A)
Cable gland with clamping claw - clamping accessible from outside, enabling quick checking that clamping is correct
Fast captive zinc-plated steel screws to close the product

Surface mounting sockets

Connection via captive screws (16 and 32 A)
Philips screws (flat or Philips screwdriver)
Angle : 75°
Removable support of active parts

Connection capacity

Type	Current	Conductors size (mm ²)	Conductors type
Straight plugs and mobile sockets	LV 16 A	1 to 2.5	Flexible
	LV 32 A	2.5 to 6	Flexible
	LV 63 A	6 to 16	Flexible
Surface mounting sockets	LV 16 A	1.5 to 4	Rigid
	LV 32 A	2.5 to 10	Rigid
	LV 63 A	6 to 25	Rigid

Dimensions

Straight plugs IP 66/67

LV 16/32 A (opposite)

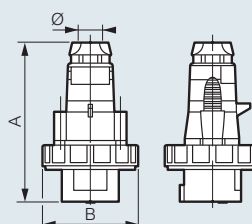

	Weight (kg)	A (mm)	B (mm)	Ø clamping and grip (mm)
LV 16 A				
2 P + ⊥	0.165	122	72.5	8 to 14
3 P + ⊥	0.175	126	81	8 to 14
3 P + N + ⊥	0.218	142	86.5	10 to 17.5
LV 32 A				
2 P + ⊥	0.255	152	94.5	10 to 17.5
3 P + ⊥	0.276	152	94.5	12 to 21.5
3 P + N + ⊥	0.325	158	101	12 to 21.5

LV 63 A (opposite)

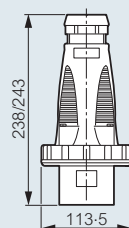

	Weight (kg)
3 P + ⊥	0.57
3 P + N + ⊥	0.64

	Ø clamping and grip (mm)
3 P + ⊥	19.3 to 28.5
3 P + N + ⊥	21.3 to 31.3

Mobile sockets IP 66/67

LV 16/32 A (opposite)

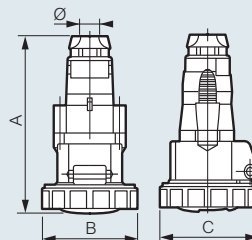

	Weight (kg)	A (mm)	B (mm)	C (mm)	Ø clamping and grip (mm)
LV 16 A					
2 P + ⊥	0.180	139	72.5	78.5	8 to 14
3 P + ⊥	0.215	144	81	89.5	8 to 14
3 P + N + ⊥	0.275	160	86.5	92	10 to 17.5
LV 32 A					
2 P + ⊥	0.320	171	94.5	103	10 to 17.5
3 P + ⊥	0.320	171	94.5	103	12 to 21.5
3 P + N + ⊥	0.387	177	101	109	12 to 21.5

LV 63 A (opposite)

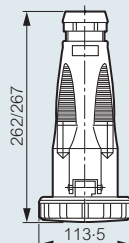

	Weight (kg)
3 P + ⊥	0.78
3 P + N + ⊥	0.85

	Ø clamping and grip (mm)
3 P + ⊥	19.3 to 28.5
3 P + N + ⊥	21.3 to 31.3

P 17 Tempra® IP 66/67 - LV 16/32/63 A

plastic plugs and sockets (continued)

P 17 Tempra® IP 66/67 - LV 63 A

pilot pin connection

■ Dimensions (continued)

Surface mounting sockets IP 66/67

LV 16/32 A (p. 192)

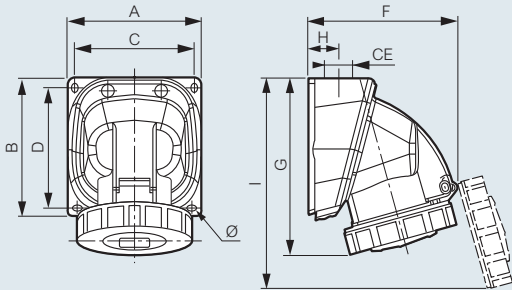

	Weight (kg)	A (mm)	B (mm)	C (mm)	D (mm)	F (mm)	G (mm)	H (mm)	I (mm)	CE (mm)	Ø (mm)
LV 16 A											
2 P + \perp	0.230	84	84	73	72	94	112	20	130	M20	4.3
3 P + \perp	0.289	100	100	88	87	108	128	24	154	M20	4.3
3 P + N + \perp	0.317	100	100	88	87	110	129	24	157	M20	4.3
LV 32 A											
2 P + \perp	0.425	110	110	98	97	126	146	30	175	M25	5.3
3 P + \perp	0.425	110	110	98	97	126	146	30	175	M25	5.3
3 P + N + \perp	0.467	110	110	98	97	136	170.5	30	205	M25	5.3

LV 63 A (p. 192)

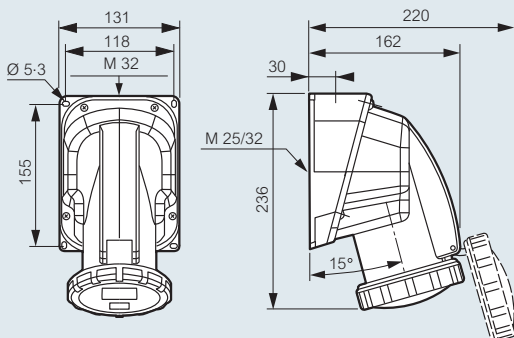

	Weight (kg)
3 P + \perp	0.90
3 P + N + \perp	0.95

■ Example of 63 A 3 P + \perp and 3 P + N + \perp pilot pin connection

The pilot pin enables the load to be removed prior to the separation of the phase pins, when the circuit is routed via a contactor

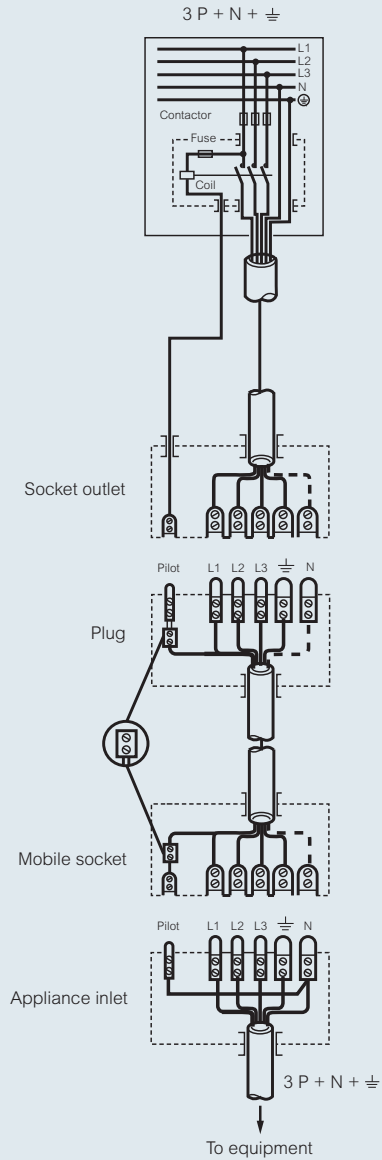

The pilot pin connection accepts 2.5-6 mm² flexible or up to 10 mm² rigid conductor. It is the small centre pin in the connection

■ Pilot cabling

	63 A	Conductors type
Plugs and mobile sockets	2.5 to 6	Flexible
Surface mounting sockets	2.5 to 10	Rigid

Hypra® and P17® combination units... safe, secure connections

Hypra®

Tough and durable units which are available with Hypra Prisinter or panel mounting sockets.

- **Lockable transparent window** - for security and instant monitoring of protection device status
- **Captive, stainless steel external screws** - for added durability
- **Off load connection and disconnection on Prisinter equipped versions** - providing additional safety for users and circuits alike
- **Choice of circuit protection** - DIN rail mounted MCB, RCBO and RCD protection options



Single socket units with switch



Single socket units with switch and MCB / RCD protection



Prisinter single socket units with RCBO protection



Lockable transparent window for security and instant monitoring of protection device status



Prisinter sockets offer a unique interlocked load break

TECHNICAL DATA

APPROVALS: BS EN 60309-1, BS EN 60309-2, BS EN 60529 (IP)
BS EN 62262 (IK)

PROTECTION: IP44, IP66/67-55 and IP66/67 ranges available
IK09

SELF EXTINGUISHING: 850°C for insulated parts, 650°C for housing
OPERATING TEMPERATURE: mechanical lock only -20°C to +100°C
with RCD -15°C to +40°C
with MCB -5°C to +40°C

P17 Tempra®

The units feature a unique plug-in design that enables the base to be wired independently of the cover, making installation both quicker and easier:

1. Fix the base on to the wall
2. Wire the protection device and the base socket connection independently of the cover
3. Close the combination unit and plug in



Interlocked switched sockets without protection



Interlocked switched sockets with DIN rail



Self assembly units



Double mechanical interlocking switch cannot be turned on unless a plug is inserted. Once switched on, the plug cannot then be removed until the switch is turned off

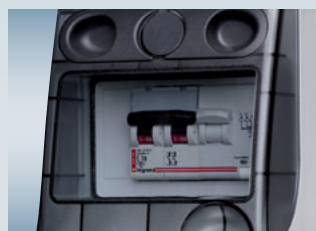

Units can be fitted with a variety of Legrand modular devices, including MCBs, RCDS, timers, contactors and indicators. Transparent window allows instant monitoring of protection device status



TECHNICAL DATA

APPROVALS: BS EN 60309-1

BS EN 60309-2

BS EN 60529 (IP)

BS EN 62262 (IK)

PROTECTION: IP44, IP55 and IP66 ranges available
IK08

SELF EXTINGUISHING: 850°C for insulated parts, 650°C for housing

OPERATING TEMPERATURE: -20°C to +100°C without protection device
-15°C to +40°C with protection device

Hypra® IP 44 combination units - LV 16/32/63 A

plastic surface mounting



Technical information and dimensions (p. 198)
Conformity to International Standards (p. 204)

Conform to BS EN 60439-1 and IEC 60439-1
 IP 44 conforms to BS EN 60529 and IEC 60529
 IK 09 conforms to BS EN 62262 and IEC 62262
 Temp. rating : -15 °C to +40 °C⁽¹⁾
 RAL 7022

Pack	Cat. Nos.		Single socket units with switch
	16 A	32 A	Double mechanical interlock
1	0592 00		100 to 130 V~ 2 P + ⊥
1	0592 03	0592 43	200 to 250 V~ 2 P + ⊥
1	0592 09	0592 49	380 to 415 V~ 3 P + ⊥
1	0592 16	0592 56	3 P + N + ⊥
	63 A		380 to 415 V~ 3 P + ⊥
1	0592 34		3 P + N + ⊥
1	0592 35		3 P + N + ⊥

Pack	Cat. Nos.		Single socket units protected by 30 mA RCBO
	16 A	32 A	Transparent plastic hinged viewing window Supplied complete with 16/32 A 30 mA RCBO With 5 module DIN rail
1	0592 07	0592 47	200 to 250 V~ with RCBO 2 P + ⊥
1	0592 14		380 to 415 V~ with RCBO 3 P + ⊥
1	0592 19	0592 59	3 P + N + ⊥

Pack	Cat. Nos.		Single socket units with switch and protected by 30 mA RCBO
	16 A	32 A	Transparent plastic hinged viewing window Supplied complete with 16/32 A 30 mA RCBO With 6 module DIN rail
1	0596 01	0596 05	200 to 250 V~ with RCBO 2 P + ⊥
1	0596 02	0596 07	380 to 415 V~ with RCBO 3 P + ⊥
1	0596 03	0596 08	3 P + N + ⊥

Pack	Cat. Nos.		Single socket units with switch and protected by RCD
	63 A		Transparent plastic hinged viewing window Supplied complete with RCD With 6 module DIN rail
1	0592 83		380 to 415 V~ 3 P + ⊥ with MCB + RCD add-on module
1	0592 84		3 P + N + ⊥ with RCD

Pack	Cat. Nos.		Prisinter single socket units protected by 30 mA RCBO
	16 A	32 A	Transparent plastic hinged viewing window Cable glands are not supplied (ISO) With 6 module DIN rail IP 44 plug inserted IP 55 lid closed or connected to an IP 66/67-55 angled plug
1	0592 24		200 to 250 V~ 2 P + ⊥
1	0592 25	0592 28	380 to 415 V~ 3 P + ⊥
1	0592 26	0592 29	3 P + N + ⊥

(1) Units with RCBO and some MCB protection devices have temperature ratings of -5 °C to +40 °C.
 Switch only units and some MCBs have increased ratings - please contact us on +44 (0) 845 605 4333

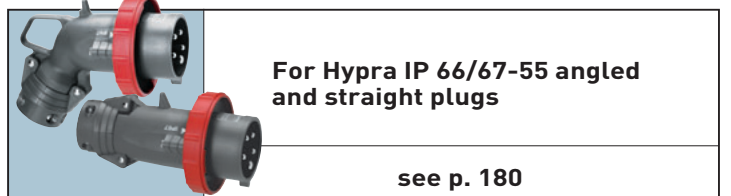
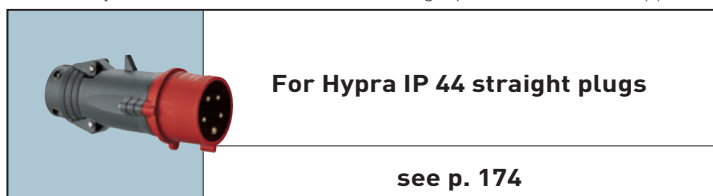

Hypra® IP 66/67-55 combination units - LV 16/32/63/125 A

plastic surface mounting



0592 65



0591 15



0596 61



Technical information and dimensions (p. 199)
Conformity to International Standards (p. 204)

Conform to BS EN 60439-1 and IEC 60439-1
IP 66/67-55 for 16 and 32 A and to BS EN 60529 and IEC 60529 for 63 and 125 A
IK 09 conforms to BS EN 62262 and IEC 62262
Temp. rating : -15 °C to +40 °C⁽¹⁾

Pack	Cat. Nos.		Single socket units with switch
	16 A	32 A	Double mechanical interlock
1	0592 60	0592 63	200 to 250 V~ 2 P + ⊥
1	0592 61	0592 64	380 to 415 V~ 3 P + ⊥
1	0592 62	0592 65	380 to 415 V~ 3 P + N + ⊥
	63 A		
1	0592 66		380 to 415 V~ 3 P + ⊥
1	0592 67		380 to 415 V~ 3 P + N + ⊥
	125 A		
1	0591 14 ⁽²⁾		380 to 415 V~ 3 P + ⊥
1	0591 15 ⁽²⁾		380 to 415 V~ 3 P + N + ⊥

Pack	Cat. Nos.		Single socket units with rail only, or complete with MCB 16/32 A
	16 A	32 A	Transparent plastic hinged viewing window Cable glands are not supplied (ISO) With 6 module DIN rail
1	0596 60		100 to 130 V~ rail only 2 P + ⊥
1	0596 61		200 to 250 V~ with MCB 2 P + ⊥
1		0596 67	380 to 415 V~ with MCB 3 P + ⊥
1		0596 68	380 to 415 V~ with MCB 3 P + N + ⊥

Pack	Cat. Nos.		Single socket units with switch and protected by 30 mA RCBO or RCD
	16 A	32 A	Transparent plastic hinged viewing window Cable glands are not supplied (ISO) With 6 module DIN rail
1	0596 51	0596 55	200 to 250 V~ with RCBO 2 P + ⊥
1	0596 52	0596 57	380 to 415 V~ with RCBO 3 P + ⊥
1	0596 53	0596 58	380 to 415 V~ with RCBO 3 P + N + ⊥
	63 A		
1	0596 81		380 to 415 V~ with RCD 3 P + N + ⊥

(1) Units with RCBO and some MCB protection devices have temperature ratings of -5 °C to +40 °C
Switch only units and some MCBs have increased ratings - contact us on +44 (0) 845 605 4333
(2) Interlocked using a Vistop switch, see p. 101



For protective devices

see p. 79

Hypra® IP 44 combination units - LV 16/32/63 A

plastic surface mounting

■ Technical information

IP 44 conforms to BS EN 60529 and IEC 60529
 IK 09 conforms to BS EN 62262 and IEC 62262
 External screws in stainless steel - Nickel plated contacts
 Icc 10 kA conforms to BS EN 60309-1 and IEC 60309-1
 Self-extinguishing : 850 °C for insulated parts (650 °C for housing)
 according to BS EN 60695-1, BS EN 60695-2, IEC 60695-1
 and IEC 60695-2
 IK 09
 RAL 7022

Units with Prisinter :

- IP 44 plug connected conforms to BS EN 60529 and IEC 60529
- IP 55 with cover closed or used with IP 66/67-55 plug
- Breaking capacity conforms to BS EN 60947-1, BS EN60947-3, IEC 60947-1 and IEC 60947-3 :

	16 A	32 A	63 A
AC1	16 A - 400 V~	32 A - 400 V~	63 A - 400 V~
AC3	8.4 kW	16.8 kW	33 kW
AC23	8.4 kW	16.8 kW	33 kW

■ Single socket units with switch (p. 196)

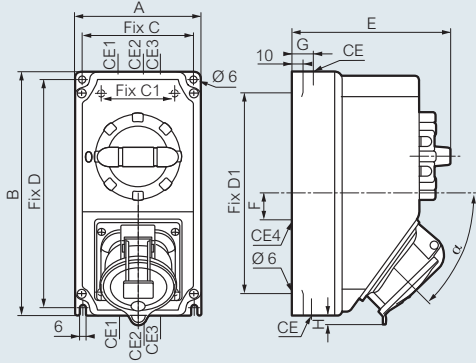

	Cat. Nos.	Dimensions (mm)										Knock-out entries for cable gland							
		110 to 130 V~	200 to 250 V~	380 to 415 V~	A	B	C	D	C1	D1	E	F	G	H	alpha	CE1	CE2	CE3	CE4
16 A	2P+⊥	0592 00	0592 03		120	230	106	216	70	190	151	25	20	1.5	46°	M 20/25	-	M 20/25	Ø 29
	3P+⊥		0592 09																
	3P+N+⊥		0592 16																
32 A	2P+⊥		0592 43		170	320	156	306	100	270	204	65	28	9	56°	M 20/25	-	M 20/25	Ø 38
	3P+⊥		0592 49																
	3P+N+⊥		0592 56																
63 A	3P+⊥		0592 34		170	320	156	306	100	270	204	65	28	21.5	56°	M 20/25	M 25/32	M 20	Ø 38
	3P+N+⊥		0592 35																

■ Single socket units protected by 30 mA RCBO and Prisinter single socket units protected by 30 mA RCBO (p. 196)

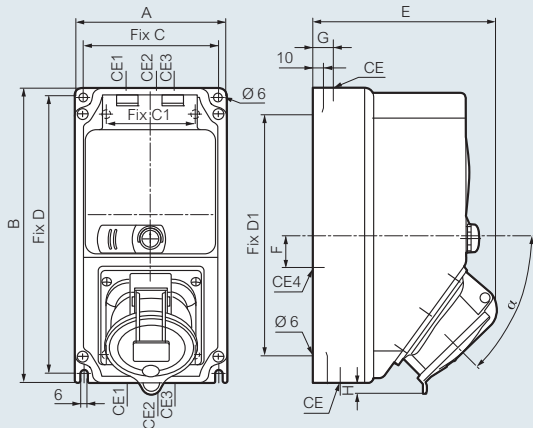

	Cat. Nos.	Dimensions (mm)										Knock-out entries for cable gland							
		200 to 250 V~	380 to 415 V~	A	B	C	D	C1	D1	E	F	G	H	alpha	CE1	CE2	CE3	CE4	
16 A	2P+⊥	0592 07		120	230	106	216	70	190	138	25	20	1.5	46°	M 20/25	-	M 20/25	Ø 29	
	3P+⊥		0592 14																
	3P+N+⊥		0592 19																
32 A	2P+⊥	0592 47		170	320	156	306	100	270	145	28	0	9	56°	M 20/25	-	M 20/25	Ø 38	
	3P+⊥		0592 25																
	3P+N+⊥		0592 59																
Prisinter 16 A	2P+⊥	0592 24		170	320	156	306	100	270	195	65	28	0	56°	M 20/25	M 25/32	M 20	Ø 38	
	3P+⊥		0592 26																
	3P+N+⊥		0592 28																
Prisinter 32 A	3P+⊥	0592 28		170	320	156	306	100	270	206	65	28	0	56°	M 20/25	M 25/32	M 20	Ø 38	
	3P+N+⊥		0592 29																

■ Single socket units with switch and protected by 30 mA RCBO or RCD (p. 196)

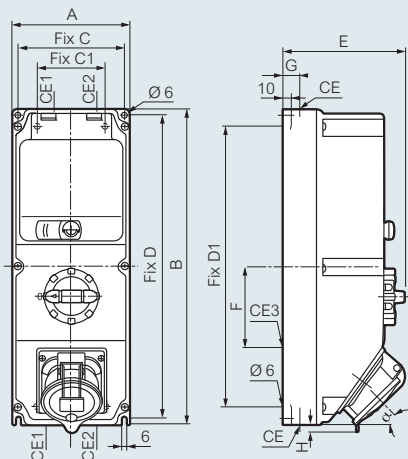

	Cat. Nos.	Dimensions (mm)										Knock-out entries for cable gland						
		200 to 250 V~	380 to 415 V~	A	B	C	D	C1	D1	E	F	G	H	alpha	CE1	CE2	CE3	
Protected by 30 mA RCBO																		
16 A	2P+⊥	0596 01		140	370	126	356	74	330	151	95	20	1.5	46°	M 20/25	M 20/25	Ø 29	
	3P+⊥		0596 02															
	3P+N+⊥		0596 03															
32 A	2P+⊥	0596 05		170	320	156	306	100	270	151	95	20	9	56°	M 20/25	M 20/25	Ø 29	
	3P+⊥		0596 07															
	3P+N+⊥		0596 08															
Protected by RCD																		
63 A	3P+⊥	0596 83		160	470	146	456	90	420	204	125	28	20	56°	M 25/32	M 20/25	Ø 38	
	3P+N+⊥		0596 84															

Hypra® IP 66/67-55 combination units - LV 16/32/63/125 A

plastic surface mounting

■ Technical information

IP 67 conforms to BS EN 60529 and IEC 60529
 IK 09 conforms to BS EN 62262 and IEC 62262
 External screws in stainless steel
 Icc 10 kA conforms to BS EN 60309-1 and IEC 60309-1
 Self-extinguishing : 850 °C for insulated parts (650 °C for housing)
 according to BS EN 60695-1, BS EN 60695-2, IEC 60695-1
 and IEC 60695-2

■ Connection and protection

Connecting socket bases

Cross section of cables inside the unit according to the current used :
 Socket 16 A : 2.5 mm²
 Socket 32 A : 6 mm²
 Socket 63 A : 16 mm²

Types of protection and number of modules

Upstream, Hypra equipped or to-be-equipped units can integrate, according to catalogue numbers, modular protective devices of various kinds :
 Legrand MCBs, RCBOs and RCDs

NB : according to the required use, it is essential to check that the protection against indirect contacts (residual current) and the protection against overloads and short circuits (Legrand circuit breakers) are both well covered

Caution : a residual current device (RCD) does not provide protection against overloads and short circuits

Short circuit withstand : for the short circuit withstand of MCBs, RCBOs and RCDs, refer to the performance pages for these products in the relevant section of this catalogue

Ratings for units equipped with residual current device (RCD) :

Ratings		Sensitivity
16 A	RCD 25 A	30 mA
32 A	RCD 40 A	30 mA
63 A	RCD 63 A	30 mA

■ Single socket units with switch (p. 197)

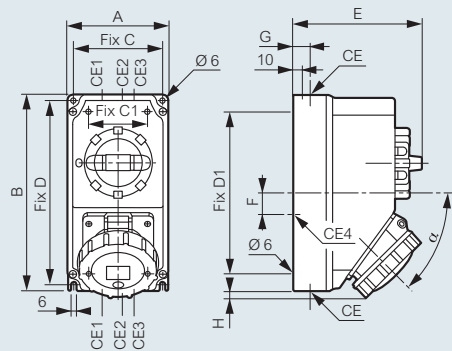

	Cat. Nos.	Dimensions (mm)											Knock-out entries for cable gland						
		200 to 250 V~	380 to 415 V~	A	B	C	D	C1	D1	E	F	G	H	α	CE1	CE2	CE3	CE4	
16 A	2P+±	0592 60							151						0				
	3P+±	0592 61							151						0				
	3P+N+±	0592 62	120	230	106	216	70	190	151	25	20	2	46°	M20/M25	-	M20/M25	M25/Ø29		
32 A	2P+±	0592 63							152					8					
	3P+±	0592 64							152					8					
	3P+N+±	0592 65							156					12					
63 A	3P+±	0592 66							152					8					
	3P+N+±	0592 67	170	320	156	306	100	270	204	65	28	18	56°	M20/M25	M25/M32	M20	M25/Ø38		

■ Single socket units with switch (continued) (p. 197)

Cat. Nos. 0591 14/15

125 A

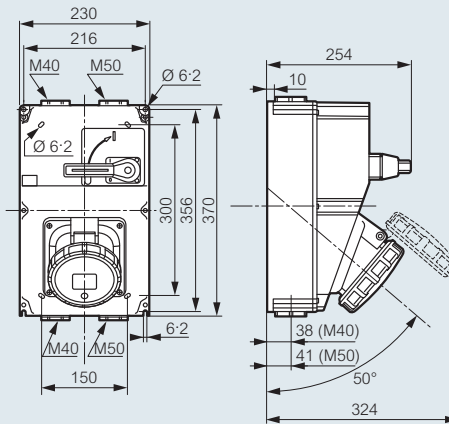

■ Single socket units with rail or MCB / protected by 30 mA RCBO or RCD (p. 197)

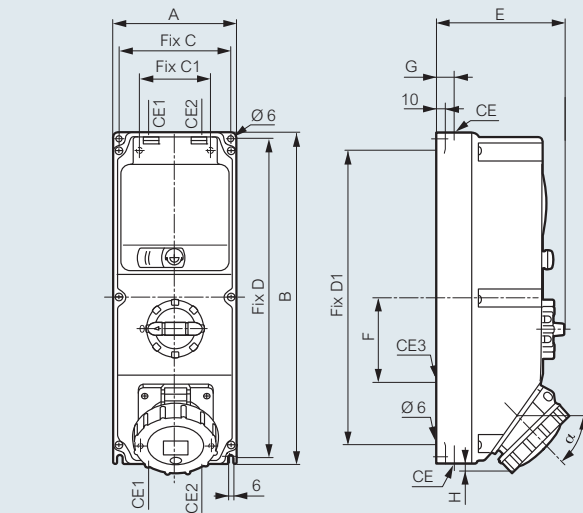

	Cat. Nos.	Dimensions (mm)											Knock-out entries for cable gland					
		110 to 130 V~	200 to 250 V~	380 to 415 V~	A	B	C	D	C1	D1	E	F	G	H	α	CE1	CE2	CE3
16 A	2P+±	0596 60	0596 61/51												151			0
	3P+±			0596 52											151			0
	3P+N+±			0596 53	140	370	126	356	74	330	151	95	20	2	46°	M20/M25	M20/M25	M25/Ø29
32 A	2P+±		0596 55												152			8
	3P+±		0596 67/57												152			8
	3P+N+±		0596 68/58												156			12
63 A	3P+N+±		0596 81	160	470	146	456	90	420	204	125	28	17	56°	M25/M32	M25/M32	M25/M38/Ø38	

P 17 Tempra® IP 44, IP 55 and IP 66 combination units - LV 16/32/63 A

plastic surface mounting

16/32 A INTERLOCKED SWITCHED SOCKETS

IK 08 according to BS EN 62262 and IEC 62262
 Self-extinguishing : 650 °C according to BS EN 60695-2-1 and IEC 60695-2-1
 Temp. rating : -20 °C to +100 °C
 Supplied without protection device (switch only)



Technical information and dimensions (p. 202)

		Without protection 125 x 220 mm		With DIN rail 125 x 280 mm			
		IP 44	IP 55	IP 44	IP 66		
				With 5 module DIN rail		With 5 module DIN rail	
Pack	Cat. Nos.	Pack	Cat. Nos.	Pack	Cat. Nos.	Pack	Cat. Nos.

LV

100 to 130 V 50/60 Hz	16 A	2 P + ⊥	1	0566 00	1	0566 20	1	0566 40	1	—
	200 to 250 V 50/60 Hz	16 A	2 P + ⊥	1	0566 01	1	0566 21	1	0566 41	1
32 A		2 P + ⊥	1	0566 09	1	0566 29	1	0566 49	1	0566 69
380 to 415 V 50/60 Hz	16 A	3 P + ⊥	1	0566 05	1	0566 25	1	0566 45	1	0566 65
		3 P + N + ⊥	1	0566 06	1	0566 26	1	0566 46	1	0566 66
	32 A	3 P + ⊥	1	0566 13	1	0566 33	1	0566 53	1	0566 73
		3 P + N + ⊥	1	0566 14	1	0566 34	1	0566 54	1	0566 74

63 A INTERLOCKED SWITCHED SOCKETS

IK 08 according to BS EN 62262 and IEC 62262
 Self-extinguishing : 650 °C according to BS EN 60695-2-1 and IEC 60695-2-1
 Temp. rating : -20 °C to +100 °C
 Supplied without protection device (switch only)



Technical information and dimensions (p. 202)

		Without protection 125 x 421 mm	With DIN rail 125 x 501 mm
		IP 66 	IP 66
Pack	Cat. Nos.	Pack	Cat. Nos.

LV

380 to 415 V 50/60 Hz	63 A	3 P + N + ⊥	1	0589 10	1	0572 99
--------------------------	------	-------------	---	---------	---	---------



For protective devices

see p. 79



Larger self assembly and factory configured units available on request

Contact us on +44 (0) 845 605 4333

P17 Tempra® IP 44 self assembly combination units - LV 16/32 A

IK 08 according to BS EN 62262 and IEC 62262

Self-extinguishing : 650 °C according to BS EN 60695-2-1 and IEC 60695-2-1
Temp. rating : -20 °C to +100 °C
Supplied without protection device (switch only)



Technical information and dimensions (p. 203)

Assembly example

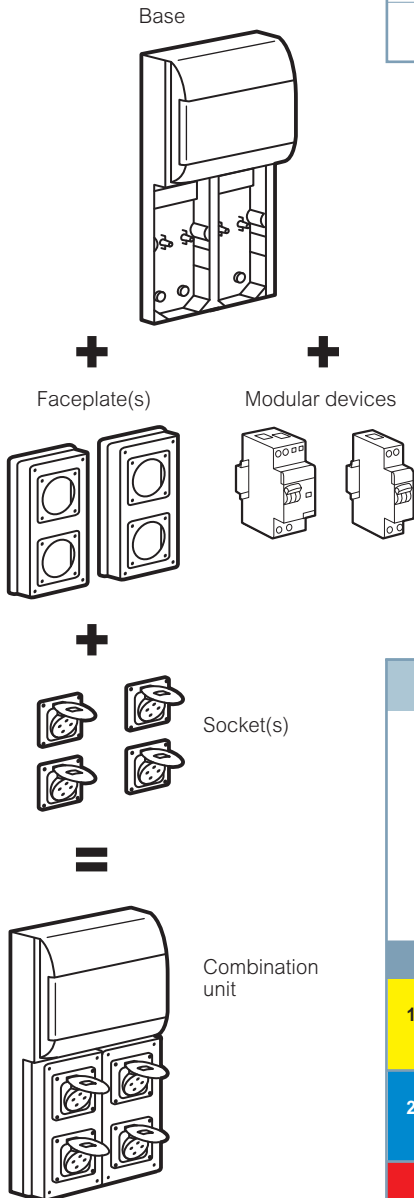

Note : Up to 9 socket units available on request

BASES FOR 125 x 220 MM FACEPLATES

16/32-63 A Surface mounting box		2 x 16 A		16/32 A		16/32 A	
Without protection option		With 5 module DIN rail		With 12 module DIN rail		With 18 module DIN rail	
Pack	Cat. Nos.	Pack	Cat. Nos.	Pack	Cat. Nos.	Pack	Cat. Nos.
2	0577 10	5	0589 38	1	0577 05	1	0577 06



125 x 220 MM FACEPLATES

1 x 16 A or 1 x 32 A		2 x 16 A		Blank plate	
Pack	Cat. Nos.	Pack	Cat. Nos.	Pack	Cat. Nos.
5	0577 12	5	0577 13 ⁽¹⁾	5	0577 15



SOCKETS FOR SELF ASSEMBLY COMBINATION UNITS

		Panel mounting sockets with modular fixing centres			
		IP 44			
		Pack	Cat. Nos.		
		LV			
110 to 130 V 50/60 Hz	16 A	2 P + ⊥	10	0576 10	
	32 A	2 P + ⊥	10	0576 08	
200 to 250 V 50/60 Hz	16 A	2 P + ⊥	10	0576 11	
	32 A	2 P + ⊥	10	0576 12	
380 to 415 V 50/60 Hz	16 A	3 P + ⊥	10	0576 17	
		3 P + N + ⊥	10	0576 23	
	32 A	3 P + ⊥	10	0576 18	
		3 P + N + ⊥	10	0576 24	

(1) Supplied with one blank plate

P 17 Tempra® IP 44, IP 55 and IP 66 combination units - LV 16/32/63 A

plastic surface mounting

IP 44, IP 55, IP 66 according to BS EN 60529 and IEC 60529
IK 08 according to BS EN 62262 and IEC 62262
Switch ratings (p. 203)

■ Interlocked switched sockets without protection - IP 44/IP 55 LV 16/32 A (p. 200)

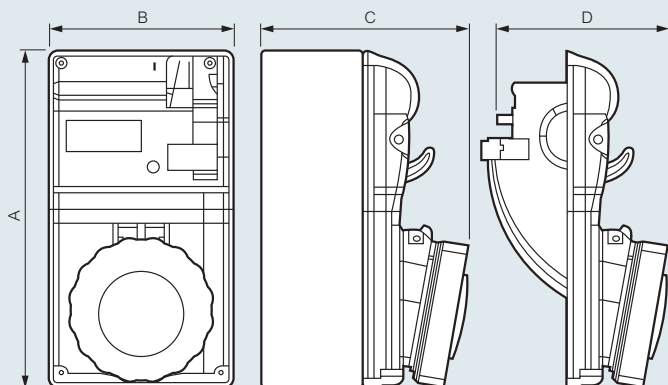

		IP 44	A	B	C	D	IP 55	A	B	C	D
		Cat. Nos.	(mm)	(mm)	(mm)	(mm)	Cat. Nos.	(mm)	(mm)	(mm)	(mm)
LV 16 A	2 P+ ⊥	0566 00/01	220	125	127	122	0566 20/21	220	125	133	128
	3 P+ ⊥	0566 05	220	125	129	124	0566 25	220	125	134	129
	3 P+N+⊥	0566 06	220	125	130	125	0566 26	220	125	135	130
LV 32 A	2 P+ ⊥	0566 09	220	125	138	133	0566 29	220	125	143	138
	3 P+ ⊥	0566 13	220	125	138	133	0566 33	220	125	143	138
	3 P+N+⊥	0566 14	220	125	139	134	0566 34	220	125	144	139

■ Interlocked switched sockets with DIN rail - IP 44/IP 66 LV 16/32 A (p. 200)

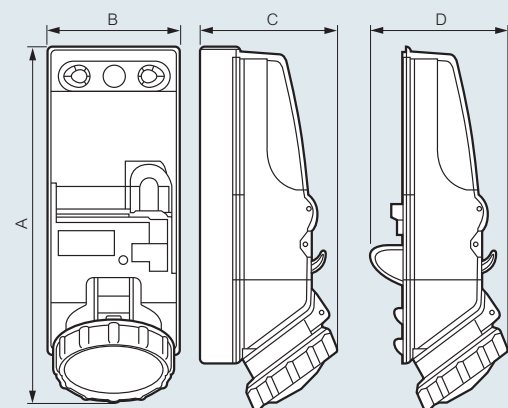

		IP 44	A	B	C	D	IP 66	A	B	C	D
		Cat. Nos.	(mm)	(mm)	(mm)	(mm)	Cat. Nos.	(mm)	(mm)	(mm)	(mm)
LV 16 A	2 P+ ⊥	0566 40/41	290	125	155	135	0566 61	300	125	155	135
	3 P+ ⊥	0566 45	290	125	155	135	0566 65	300	125	155	135
	3 P+N+⊥	0566 46	290	125	155	135	0566 66	300	125	155	135
LV 32 A	2 P+ ⊥	0566 49	295	125	155	145	0566 69	310	125	155	145
	3 P+ ⊥	0566 53	295	125	155	145	0566 73	310	125	155	145
	3 P+N+⊥	0566 54	295	125	155	145	0566 74	310	125	155	145

■ Interlocked switched sockets without protection/ with DIN rail - IP 66 LV 63 A (p. 200)

Cat. Nos. 0589 10/0572 99

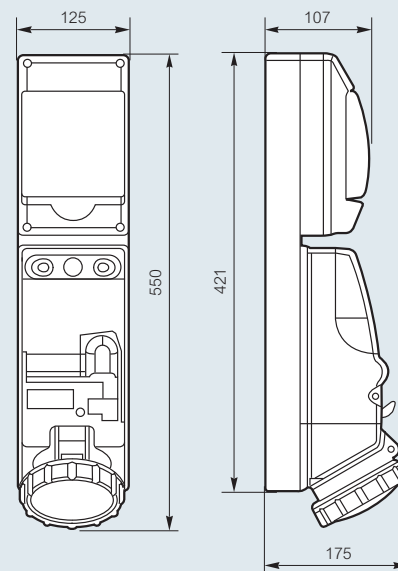

P 17 Tempra® IP 44 self assembly combination units - LV 16/32 A

plastic surface mounting

■ Box and bases without DIN rail (p. 201)

Box Cat. No. 0577 10

Base Cat. No. 0589 38

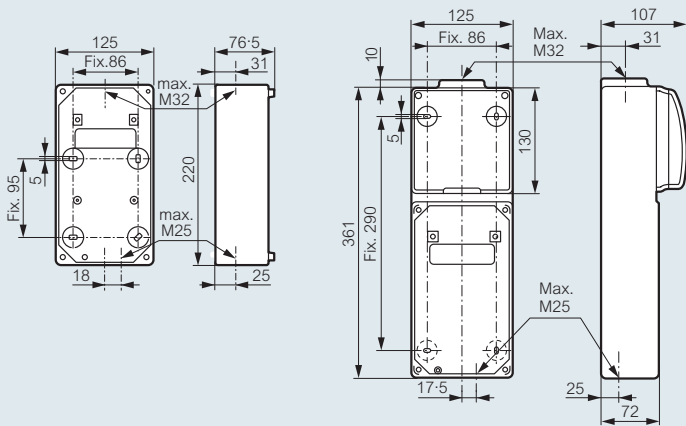

Base Cat. No. 0577 05

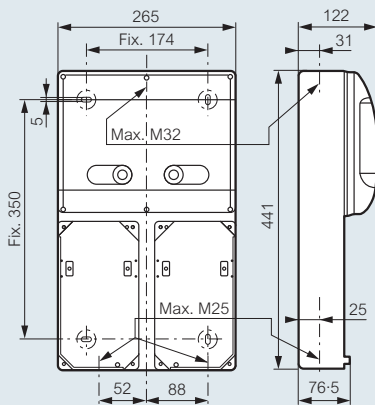

Base Cat. No. 0577 06

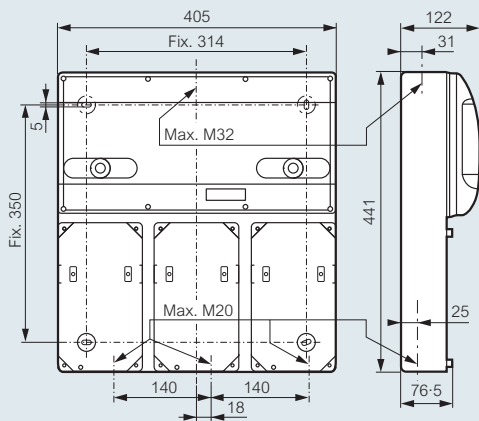

■ Faceplates modular fixing centre sockets (p. 201)

Cat. No. 0577 12

Cat. No. 0577 13

Cat. No. 0577 15

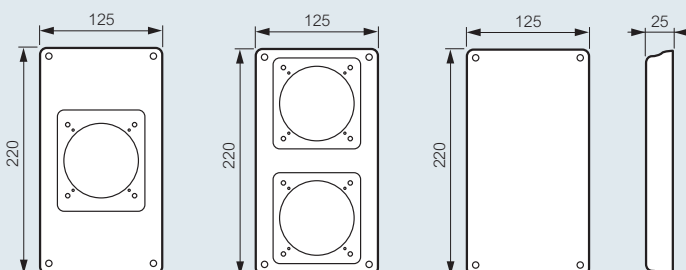

■ Panel mounting sockets with modular fixing centres (70 x 70 mm) - IP 44

LV 16/32 A (p. 201)

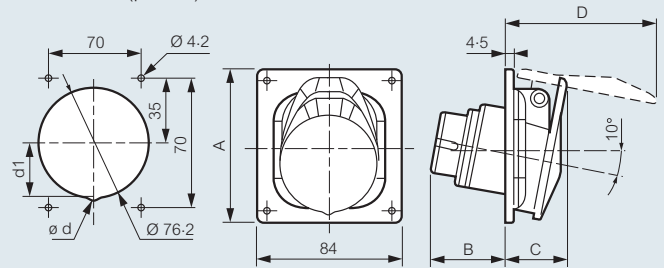

	Cat. Nos.	Material	Weight (Kg)	A (mm)	B (mm)	C (mm)	D (mm)	Ø d (mm)	d1 (mm)
16 A	2 P + \perp	0576 10/11	Plastic	0-110	84	42	33	83.5	-
	3 P + \perp	0576 17	Plastic	0-140	84	43	34.5	91.3	-
	3 P + N + \perp	0576 23	Plastic	0-165	84	43	36.5	100	-
32 A	2 P + \perp	0576 08/12	Plastic	0-220	94	54	44	112	-
	3 P + \perp	0576 18	Plastic	0-220	94	54	44	112	-
	3 P + N + \perp	0576 24	Plastic	0-255	94	54	45	120	8 36

■ P 17 switch ratings (p. 201)

Usage category	400 V ~ 3 phase		
	16 A	32 A	63 A
AC23	8.4 kW	16.8 kW	
AC22			33 kW
AC23B			33 kW

industrial plugs and sockets to International Standards

Conform to BS EN 60309-1, BS EN 60309-2, IEC 60309-1 and IEC 60309-2

■ Voltage identification

Colours specified by standards and the clock indexing of the contact tubes in socket outlets

■ With Legrand Hypra and P 17 Tempra industrial plugs and sockets, your installations will comply fully with international standards :

- Standard IEC 60309-1 : this defines the safety regulations (protection of workers) which should be observed in the manufacture of industrial power sockets and plugs
- Standard IEC 60309-2 : this defines the interchangeability regulations for the dimensions of equipment with pins and sockets

These safety regulations, together with the requirements of standard BS EN 60309-1, define the safety conditions necessary for normal operation. It is prudent to go one step further and insist on equipment which ensures the safety of the persons as a priority as well as ease of operation. Many manufacturers therefore use sockets which incorporate a switch, to avoid on-load disconnection (eg : Hypra Prisinter).

ELV by position of the minor keyway

24 V~ 50 – 60 Hz Violet

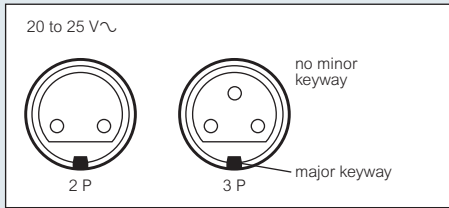

42 V~ 50 – 60 Hz White

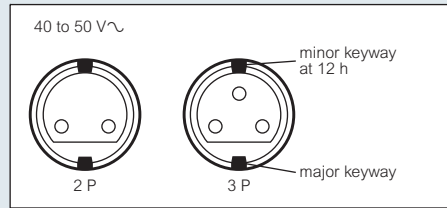

42 V= White

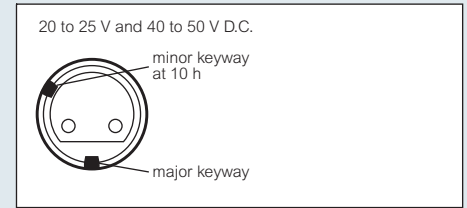

LV by the position of the earth contact tube in relation to the major keyway in the socket outlets

110 V~ 50 – 60 Hz Yellow

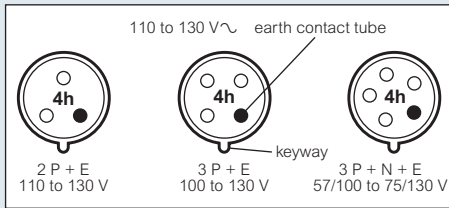

230 V~ 50 – 60 Hz Blue

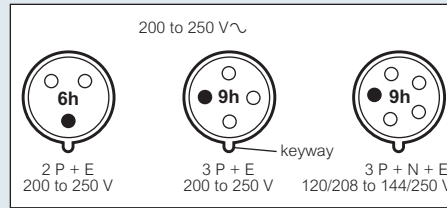

400 V~ 50 – 60 Hz Red

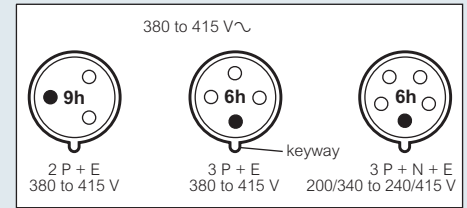

500 V~ 50 – 60 Hz Black

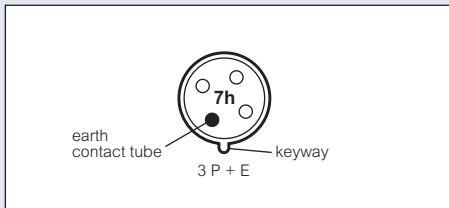

> 50 to 500 V~
100 to 300 Hz inclusive Green

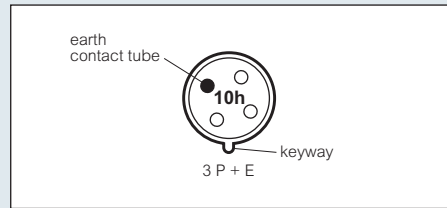

■ Terminal connection capacity, Prisinter rating and contact sizes

• Terminal connection capacity

	Hypra/P 17 Tempra
ELV 16/32 A	1 x 10 mm (A + B)
LV 16 A	1 x 4 mm (A) 1 x 2.5 mm (B)
LV 32 A	1 x 10 mm (A) 1 x 6 mm (B)
LV 63 A	1 x 25 mm (A) 1 x 16 mm (B)
LV 125 A	1 x 70 mm (A) 1 x 50 mm (B)

• Hypra Prisinter breaking capacity for 3 x 400 V~ according to IEC 60947-1-3

Category	16 A	32 A	63 A
AC 1	16 A	32 A	63 A
AC 23	8.4 kW	16.8 kW	33 kW
AC 3	8.4 kW	16.8 kW	33 kW

• Diameters of pins or contact tubes (mm)

		16 A	32 A	63 A	125 A
24 V~ 42 V~ 42 V=	Phase	6	6	-	-
	Phase + Neutral	5	6	8	10
110 V~ 230 V~ 400 V~ 440 V~ 500 V~	Earth	7	8	10	12
	Pilot	-	-	6	6

(A) Panel mounting sockets
(B) Mobile sockets and plugs

Protection classifications

Protection against solid bodies and liquids : Index of protection - IP xx

Degree of protection of enclosures of electrical equipment in accordance with standards IEC 60529, BS EN 60529
Up to 1 000 V~ and 1 500 V~

1st figure : protection against solid bodies

IP	tests	
0		No protection
1		Protected against solid bodies of 50 mm and greater (e.g. accidental contact with the hand)
2		Protected against solid bodies of 12.5 mm and greater (e.g. finger)
3		Protected against solid bodies of 2.5 mm and greater (e.g. tools, wires)
4		Protected against solid bodies larger than 1 mm (e.g. thin tools and fine wires)
5		Protected against dust (no harmful deposit)
6		Completely protected against dust

2nd figure : protection against liquids

IP	tests	
0		No protection
1		Protected against vertically falling drops of water (condensation)
2		Protected against drops of water falling up to 15° from the vertical
3		Protected against water sprayed up to 60° from the vertical
4		Protected against splashing water from all directions
5		Protected against jets of water from all directions
6		Protected against powerful jets of water from all directions
7		Protected against the effects of temporary immersion in water
8		Protected against the continuous effects of immersion in water having regard to specific conditions

Protection against mechanical impact : Index of protection - IK

According to standards IEC 62262 and BS EN 62262

IK	Tests	Impact energy (in Joules)
IK 00		0
IK 01		0.15
IK 02		0.2
IK 03		0.35
IK 04		0.5
IK 05		0.7
IK 06		1
IK 07		2
IK 08		5
IK 09		10
IK 10		20

(1) A product previously classed as IP xx-7 can be assumed to fulfill the conditions of an IP xx - IK 08

This table can be used to ascertain the resistance of a product to an impact given in Joules from the IK code (graduated from 00 to 10). It can also be used to ascertain the correspondence with the old IP code 3rd digit and the corresponding external "Ag" conditions.

The contents of the Protection Classifications charts are for guidance only. If you have any doubt as to the interpretation of the information contained therein, please refer either to the standard itself or contact Legrand.

Health and Safety at Work, etc. Act. 1974

Statement to Purchasers and Prospective Purchasers

1. Section 6 of this Act provides that manufacturers, designers, importers or suppliers of articles for use at work have a duty to ensure so far as is reasonably practical, that the article will be safe and without risk to health when properly used. An article is not regarded as being 'properly used' if it is used without regard to any relevant information or advice relating to its use made available by the manufacturer, designer, importer or supplier.

2. With regard to these provisions the following is given as a guide to the information which is readily available to you. This information relates to those products detailed in our catalogue(s) or associated literature or may be obtained by specific request to the Company.

3. All products should be installed and maintained in accordance with good engineering practice and relevant British or

other applicable standards, regulations for the installation of equipment by the Institute of Electrical Engineers or any other applicable Codes of Practice.

Health and Safety at Work Act

The Electricity at Work Regulations, 1989

1. All installations and maintenance should be carried out within the provision of the above Act and by persons so qualified as defined in the Act.

2. Information and advice on the suitability of our products can be obtained from Legrand Electric Limited on specific request.

For information concerning wiring device standards outside the UK contact :

BSI

Customer Services

09:00 to 17:00 – Monday to Friday

Tel : +44 (0) 20 8996 9001

Fax : +44 (0) 20 8996 7001

Email : cservices@bsi-global.com

marking appears on electrical or electronic products from Legrand and enables the circulation of goods outside the UK.



Conditions of sale
Please consult our current price list

In accordance with its policy of continuous improvement the Company reserves the right to change specifications and designs without notice. All illustrations, descriptions, dimensions and weights in this catalogue are for guidance and cannot be held binding on the Company.

Cat. Nos.	Page No.	Cat. Nos.	Page No.	Cat. Nos.	Page No.	Cat. Nos.	Page No.	Cat. Nos.	Page No.	Cat. Nos.	Page No.	Cat. Nos.	Page No.
0010 00		0044 17	26	0048 40	42	0066 40	79	0068 45	79	0079 00	84	0091 49	83
		32	116	42	-	41	-	46	-	01	-	50	-
0013 01	35	33	-	44	-	42	-	52	-	11	-	58	-
02	-	36	-	46	-	45	-	53	-	19	-	59	-
04	-	37	-	48	-	46	-	54	-	20	-	60	-
06	-	40	59	50	-	47	-	56	-	21	-	61	-
08	-	41	-	52	-	48	-	58	-	22	-	62	-
98	-	42	-	54	-	49	-	60	-	29	-	65	-
0016 65	61	43	-	55	-	51	-	61	-	30	-	66	-
90	-	44	100	56	-	53	-	62	-	31	-	71	-
91	-	47	-	58	-	54	-	63	-	62	-	72	-
0019 55	33	53	116	79	43	55	-	64	-	64	-	73	-
61	-	54	-	80	-	56	-	65	-	65	-		
62	-	55	-	81	-	57	-	66	-	66	-	0100 00	
64	-	58	-	82	-	58	-	0069 12	79	67	-	0102 02	91
65	-	63	-	84	-	59	-	13	-	75	-	05	-
66	-	64	-	85	-	60	-	14	-	77	-	06	-
68	-	68	-	86	-	61	-	16	-	78	-	10	-
69	-	83	-	88	-	62	-	18	-	79	-	12	-
0031 43	116	84	-	0049 05	90	65	-	20	-	80	-	16	-
0037 00	123	85	-	06	-	66	-	21	-	0080 13	84	20	-
21	127	86	-	26	-	67	-	22	-	14	-	25	-
0040 68	114	87	-	37	-	68	-	23	-	15	-	30	-
69	-	88	-	38	-	69	-	24	-	31	-	50	-
70	-	0046 00	85	39	-	71	-	25	-	32	-	63	-
75	-	02	-	42	-	73	-	26	-	33	-	96	-
77	-	10	-	43	-	74	-	32	-	0086 96	83	96	-
78	-	13	-	44	-	75	-	33	-	0087 14	83	0120 02	92
85	-	15	-	83	59	76	-	34	-	0089 06	83	04	-
0041 11	116	17	-	88	90	77	-	36	-	09	-	06	-
13	-	18	-	96	59	78	-	38	-	10	-	10	-
14	114	20	-			79	-	40	-	0123 00	91	12	-
16	-	21	-	0050 00		80	-	41	-	01	-	01	-
26	-	22	-	0057 99	90	81	-	42	-	12	-	02	-
29	-	24	-	0058 04	89	82	-	43	-	15	-	04	-
31	-	25	-	06	-	91	-	44	-	16	-	06	-
32	-	31	-	08	-	92	-	45	-	17	-	08	-
33	-	34	-	16	-	93	-	46	-	18	-	10	-
47	-	36	-	18	-	95	-	92	-	27	-	12	-
83	-	38	-	28	-	97	-	93	-	28	-	16	-
85	-	45	-	38	-	0067 00	79	94	-	29	-	0130 01	92
0043 01	100	46	-	48	-	01	-	96	-	30	-	02	-
02	-	50	-	0063 83	79	02	-	98	-	35	-	04	-
05	-	52	-	0064 75	79	03	-	0070 00	79	93	-	06	-
07	-	53	-	76	-	04	-	01	-	94	-	08	-
10	-	60	-	77	-	06	-	02	-	95	-	10	-
14	-	63	-	95	-	52	-	03	-	96	-	12	-
21	-	64	-	96	-	53	-	04	-	99	-	16	-
22	-	72	86	97	-	54	-	05	-	0090 00	83	20	-
23	-	73	-	0065 70	79	56	-	06	-	01	-	25	-
25	-	74	-	71	-	58	-	0073 50	83	02	-	95	-
26	-	81	-	72	-	60	-	51	-	11	-	0133 00	91
27	-	91	-	75	-	61	-	53	-	12	-	01	-
30	-	94	-	76	-	62	-	54	-	13	-	02	-
31	-	0047 75	85	78	-	63	-	0077 45	84	14	-	04	-
34	-	76	-	79	-	64	-	46	-	18	-	06	-
36	-	77	-	81	-	66	-	47	-	19	-	08	-
38	-	78	-	83	-	72	-	77	-	23	-	10	-
42	-	0048 01	42	84	-	73	-	78	-	24	-	12	-
45	-	03	-	85	-	74	-	80	-	25	-	16	-
47	-	05	-	86	-	76	-	81	-	26	-	20	-
50	-	06	-	87	-	78	-	83	-	53	-	25	-
54	-	07	-	88	-	80	-	84	-	56	-	94	-
55	-	10	-	89	-	81	-	0078 79	84	57	-	0140 04	92
58	-	11	-	0066 25	79	82	-	81	-	58	-	06	-
62	-	14	-	26	-	83	-	83	-	59	-	10	-
65	-	19	-	27	-	84	-	84	-	74	-	12	-
67	-	20	-	28	-	85	-	86	-	75	-	16	-
70	-	22	-	29	-	86	-	87	-	76	-	20	-
74	-	24	-	31	-	0068 32	79	88	-	77	-	25	-
75	-	25	-	33	-	36	-	89	-	82	-	32	-
78	-	30	-	34	-	38	-	90	-	0091 40	83	40	-
82	103	32	-	35	-	40	-	94	-	41	-	45	-
83	-	34	-	36	-	41	-	95	-	42	-	50	-
85	-	35	-	37	-	42	-	97	-	43	-	0143 00	91
0044 09	124	36	-	38	-	43	-	98	-	46	-	02	-
16	26	38	-	39	-	44	-	99	-	47	-	04	-
										48	-	06	-

Cat. Nos.	Page No.	Cat. Nos.	Page No.	Cat. Nos.	Page No.	Cat. Nos.	Page No.	Cat. Nos.	Page No.	Cat. Nos.	Page No.	Cat. Nos.	Page No.										
0175	70	93	0250	45	64	0255	58	67	0300	0352	14	16	0361	00	25	0365	42	28	0371	77	134		
0178	04	93		46	-		60	-			15	-		01	-		45	14		78	-		
	60	-		47	-		88	-			40	-		02	-		51	-		79	-		
	65	-		48	-		89	-			41	-		03	-		52	-		80	135		
	70	-		49	-		96	-			42	-		05	-		53	-		81	-		
	75	-		50	-		97	-			45	-		06	-		54	-		82	-		
	0- 04	93		51	-	0257	92	68			46	-		09	-		56	-		83	-		
0199	02	94		52	-		93	-			47	-		10	-		57	-		84	-		
	09	-		53	-		94	-			53	-		50	26		64	-		85	-		
	15	-		54	-		95	-			0353	06	31	51	-		78	29		86	-		
	16	-		55	-	0258	00	68			07	-		52	-		79	-		87	-		
	17	-		58	-		01	-			08	-		53	-		80	26	0372	00	138		
	20	-		59	-		02	-	0320	12	157			54	-		81	-		01	-		
	21	-		60	-		07	-		15	-			55	-		0366	38	50	02	-		
	22	-		61	-		08	-		22	-		0358	00	38		39	-		03	-		
	23	-		62	-		09	-		24	-			01	-		56	-		04	-		
0200	00			63	-		14	-		30	-			02	-		58	-		04	-		
				63	-		14	-		30	-			59	-		44	23		07	-		
				98	-		15	-		31	-			0362	40	18	0367	01	50	08	-		
0215	01	89		99	-		16	-		32	-			42	-		02	-		09	-		
	03	-	0252	01	65		22	-		37	-			46	21		10	-		10	-		
	04	-		02	-		23	-		38	-			48	-		80	26		11	-		
	05	-		03	-	0260	14	64		39	-			50	18		81	-		12	-		
0216	00	89		04	-		38	65		40	-			51	-		82	-		20	-		
	01	-		05	-		54	66		42	-			52	-		83	-		21	-		
	04	-		06	-		55	66		43	-	0359	00	38			84	-		40	-		
	05	-		11	-		60	67		65	-			40	-		56	-	0368	04	28	41	-
0225	12	101		12	-		61	-		70	-			50	-		61	-		42	-		
	15	-		13	-		64	-		72	-			51	-		63	-		43	-		
	16	-		14	-	0261	60	68		88	-			64	-		17	-		44	-		
	18	-		15	-		64	-	0342	11	41			60	-		71	-		46	-		
	20	-		16	-		65	-		13	-			61	-		72	-		47	-		
	22	-		22	-		66	-		15	-			70	-		19	-		47	-		
	25	-		23	-		67	-		17	-			71	-		75	-		54	139		
	27	-		24	-		68	-		19	-			80	-		76	-		55	-		
	34	-		25	-		70	-		21	-			90	-		81	-		56	139		
	39	-		26	-		71	-		23	-	0360	00	23			85	21		60	138		
	44	-		30	-		72	-		25	-			01	-		86	-		61	-		
	46	-		31	-		73	-		27	-			02	-		87	-		62	-		
	51	-		32	-		74	-	0344	18	21			04	-		91	18		63	-		
	53	-		33	-		76	-		0347	45	23		05	-		92	-		64	-		
	54	-		34	-		80	-		50	-			07	-		93	-		67	-		
	56	-		35	-		81	-	0348	04	29			09	-		94	-	0370	10	50	68	-
0227	04	101		36	-		82	-		05	-			12	-		95	-		69	-		
	07	-		37	-		83	-		17	-			14	-		96	21		70	-		
	22	-		96	-		84	-		34	-			15	-		97	-		71	-		
	32	-		97	-		86	-		35	-			16	-	0363	00	14		72	-		
	98	-		98	-		86	-		36	-			17	-		01	-		73	-		
0250	00	64		99	-	0262	00	64		36	-			18	-		59	25		74	-		
	01	-	0253	30	66		05	-		47	31			19	-		60	-		79	-		
	02	-		31	-		06	-		50	29			20	-		61	-		80	139		
	03	-		32	-		07	-		51	-			21	-		62	-		81	-		
	04	-		47	-		08	-		52	-			22	-		63	-		82	-		
	05	-		48	-		09	65		88	-			23	-		64	-		83	-		
	06	-		49	-		21	66	0349	50	21			24	-		65	-		84	-		
	07	-		54	-		26	-		59	21			31	-		69	-		85	-		
	08	-		55	-		27	-	0350	07	38			33	-		90	21		86	-		
	09	-		56	-		30	-		13	-			34	-		91	-		86	-		
	16	-		71	-		35	-		17	-			40	-		92	-		37	45		
	17	-		72	-		40	67		22	-			42	-	0364	01	14		60	-		
	18	-		73	-		44	-		28	-			46	-		06	16		61	-		
	19	-		98	-		45	67		28	-			49	-		08	18		62	-		
	20	-		99	-		50	-		33	-			50	-		09	-		65	-		
	21	-	0255	21	67		51	-		43	40			52	-		16	16		68	-		
	24	-		22	-		60	68		44	38			55	-		36	18		89	-		
	25	-		23	-		64	-		47	-			56	-		37	-		95	44		
	26	-		24	-		64	-		58	40			58	-		39	-		96	-		
	27	-		25	-		65	-		90	-			59	-		40	23		98	-		
	28	-		26	-		66	-		92	-			61	-		42	-		98	-		
	29	-		27	-		67	-		93	-			64	-		69	26		0374	00	44	
	36	-		37	-		68	-		94	-			67	-		78	-		02	26		
	37	-		38	-		69	-	0352	00	16			67	-		89	14		03	44		
	38	-		41	-		70	-		01	-			75	-		95	14		04	140		
	39	-		42	-		85	65		02	-			87	-		97	-		07	26		
	40	-		43	-		86	-		03	-			90	-	0365	11	28		19	45		
	41	-		44	-		88	-		05	-			91	-		35	14		31	-		
	44	-		44	-		90	-		06	-			92	-		39	28		33	45		
				56	-		91	-		11	-			93	-		40	14		34	-		
				57	-			-		13	-			99	-		41	28		35	44		

Cat. Nos.	Page No.	Cat. Nos.	Page No.	Cat. Nos.	Page No.	Cat. Nos.	Page No.	Cat. Nos.	Page No.	Cat. Nos.	Page No.	Cat. Nos.	Page No.	Cat. Nos.	Page No.										
0374	38	45	0376	88	160	0382	31	155	0383	50	155	0395	98	50	0442	62	-	0521	25	175	0530	80	182		
	47	44		89	-		32	-		51	-		0399	30	14		63	-		26	-		81	-	
0375	01	140		90	-		33	-		52	-			31	-		64	-		27	-	0536	03	169	
	02	-		92	-		34	-		53	-			32	-		65	-		72	-		04	-	
	04	-		97	-		35	-		54	-			33	-		66	-		73	-		99	176	
	05	-	0381	00	155		36	-		55	-			34	-		67	-		74	-	0537	24	176	
	07	-		01	-		37	-		60	-			35	-		68	-		96	168		49	169	
	10	-		02	-		38	-		61	-			36	-		69	-		0522	03	168		73	176
	11	-		03	-		39	-		62	-			37	-		70	-		04	-		74	-	
	12	-		04	-		70	-		63	-			38	-		71	-		13	-	0538	00	169	
	13	-		05	-		71	-		64	-			39	-			0470	01	-	14	-		01	-
	24	141		06	-		72	-		65	-			40	-			02	-		19	175		09	-
	25	-		07	-		73	-		66	-			41	-			03	-		20	-		23	-
	27	-		08	-		74	-		67	-			42	-			04	-		23	-		24	-
	30	-		09	-		75	-		68	-			43	-			21	-		24	-		33	-
	31	-		10	-		76	-		69	-			44	-			22	-		29	-		34	-
	32	-		11	-		80	-		70	-			45	-			23	-		33	-		43	-
	34	-		12	-		81	-		71	-			46	-			24	-		34	-		44	-
	35	-		13	-		82	-		72	-			51	-			25	-		39	-		83	-
	40	-		14	-		83	-		73	-			52	-	0472	20	112		43	-		84	-	
	42	-		15	-		84	-		74	-			54	-	0495	94	126		44	-	0553	03	192	
	44	-		16	-		85	-		75	-			55	-	0496	80	124		49	168		07	-	
	46	-		17	-		86	-		76	-			56	-		82	-		59	169		08	-	
	47	-		18	-		90	-		77	-			59	-	0497	50	126		83	175		23	-	
	50	140		19	-		91	-		78	-			63	-		54	-		84	-		27	-	
	51	-		20	-		92	-		79	-			64	-	0498	32	124		89	-		28	-	
	52	-		21	-		93	-		80	-			65	-	0499	83	126		0524	01	175		50	189
	53	-		22	-		94	-		81	-			69	-					02	-		53	-	
	54	-		23	-		95	-		82	-			80	-	0500 00				05	-		57	-	
	55	-		24	-		96	-		84	-			81	-	0511	06	-		19	-		58	-	
	56	-		25	-	0383	00	155		85	-			86	-		10	-		21	-		73	-	
	57	-		26	-		01	-		92	156			87	-		11	-		22	-		78	-	
	60	-		27	-		02	-		94	-			88	-		25	-		25	-	0555	50	189	
	61	-		28	-		03	-		95	-			26	-		26	-		61	-		53	-	
	62	-		29	-		04	-		96	-			30	-	0400 00				62	-		57	-	
	63	-		30	-		05	-		97	-		0427	85	108		31	-		0527	02	169		58	-
	65	141		31	-		06	-	0384	90	156			86	-		46	-		03	-		73	-	
	66	-		32	-		07	-		91	-			87	-		50	-		18	176		78	-	
	67	-		33	-		08	-		92	-			88	-		51	-		19	-	0562	03	192	
	68	-		34	-		09	-	0390	10	147			89	-		55	-		32	-		07	-	
	69	-		35	-		10	-		11	-			90	-		56	-		33	-		08	-	
	82	-		40	-		11	-		13	-			92	-		60	-		42	-		23	-	
	85	-		41	-		12	-		14	-		0428	40	108		61	-		43	-		27	-	
	86	140		42	-		13	-		15	-			41	-		75	-		82	-		28	-	
	87	-		43	-		14	-		17	-			42	-		76	-		83	-	0563	03	192	
	88	-		44	-		15	-		18	-			43	-		80	-		99	-		07	-	
	89	-		60	154		16	-		31	148			44	-		81	-		0528	72	176		08	-
	90	-		61	-		17	-		32	-			45	-		0519	10	168		73	-		23	-
	95	-		62	-		18	-		33	-			47	-		19	-		74	-		27	-	
	96	-		63	-		19	-		34	-			55	-		20	-		0529	03	169		28	-
0376	06	160	0382	00	156		20	-		71	-			56	-		30	-		04	-	0566	00	200	
	08	-		01	-		21	-		72	-			57	-		40	-		13	-		01	-	
	09	-		02	-		22	-		73	-			58	-		70	-		14	-		05	-	
	10	-		03	-		23	-		74	-			59	-		80	-		19	176		06	-	
	39	-		04	-		24	-	0394	46	147			60	-		0520	02	168		20	-		09	-
	41	-		10	155		25	-		47	-			61	-		03	-		33	-		13	-	
	42	-		11	-		30	-		49	26			62	-		04	-		34	-		14	-	
	43	-		12	-		31	-		77	148			70	-		18	-		39	-		20	-	
	44	-		13	-		32	-		78	-			71	-		19	-		40	-		21	-	
	45	-		14	-		33	-		86	-			72	-		22	-		43	-		25	-	
	46	161		15	-		34	-		88	-			73	-		23	-		44	-		26	-	
	47	-		16	-		35	-		89	-			74	-		24	-		49	169		29	-	
	48	-		17	-		36	-	0395	00	154			75	-		29	-		59	168		33	-	
	50	160		18	-		37	-		01	-			77	-		32	-		83	176		34	-	
	60	-		19	-		38	-		02	-			99	-		33	-		84	-		40	-	
	61	-		20	-		39	-		05	-		0442	31	-		34	-		90	-		41	-	
	62	-		21	-		40	-		06	-			32	-		42	-		0530	06	182		45	-
	63	-		22	-		41	-		09	-			33	-		43	-		10	-		46	-	
	64	-		23	-		42	-		10	-			34	-		44	-		11	-		49	-	
	66	-		24	-		43	-		15	-			35	-		49	168		46	-		53	-	
	67	-		25	-		44	-		16	-			36	-		59	-		50	-		54	-	
	68	-		26	-		45	-		19	-			37	-		73	175		51	-		61	-	
	69	-		27	-		46	-		20	-			38	-		82	-		56	-		65	-	
	70	-		28	-		47	-		21	-			39	-		83	-		60	-		66	-	
	71	-		29	-		48	-		96	140			40	-		89	-		61	-		69	-	
	87	-		30	-		49	-		97	-			61	-		0521	01	181		76	-		73	-

Obsolete items cross-reference tables

Cat. Nos.	Page No.	Cat. Nos.	Page No.	Cat. Nos.	Page No.	Cat. Nos.	Page No.
0566 74	200	0592 60	197	4130 91	116	6071 67	58
0572 99	200	61	-	93	-	68	-
0573 51	189	62	-	95	-	69	-
54	-	63	-	96	-	70	59
58	-	64	-	97	-	72	-
59	-	65	-	98	-	75	-
0574 31	189	66	-			76	-
34	-	67	-	6000 00		80	-
38	-	83	196	6019 32	33	81	-
39	-	84	-	74	-	82	-
0575 11	189	0594 27	182	76	-	83	58
14	-	28	-	78	-	6072 00	59
18	-	37	-	81	-	01	-
19	-	38	-	82	-	02	-
81	-	47	-	83	-	03	-
84	-	48	-	85	-	04	-
88	-	87	-	86	-	05	-
89	-	88	-	87	-	06	-
0576 08	189	0595 02	182	88	-	10	58
10	-	03	-	6022 51	61	11	-
11	-	12	-	52	-	12	-
12	-	13	-	53	-	13	-
17	-	22	-	54	-	14	-
18	-	23	-	6027 10	83	15	-
23	-	32	-	11	-	16	-
24	-	33	-	6037 70	123	17	-
0577 05	201	0596 01	196	71	-	18	-
06	-	02	-	6064 10	84	6360 95	50
10	-	03	-	11	-	96	-
12	-	05	-	12	-	6361 00	50
13	-	07	-	13	-	01	-
15	-	08	-	14	-	02	-
0580 54	189	51	197	15	-	03	-
59	-	52	-	6071 00	58	05	-
0581 21	189	53	-	01	-	06	-
34	-	55	-	02	-	07	-
38	-	57	-	03	-	08	-
39	-	58	-	04	-	09	-
0582 01	189	60	-	05	-	11	-
14	-	61	-	06	-	12	-
18	-	67	-	07	-	13	-
19	-	68	-	08	-	14	-
84	-	81	-	09	-	15	-
89	-			10	-	16	-
0587 00	192	0900 00		11	-	17	-
04	-	0920 32	38	12	-	18	-
05	-	42	-	13	-	19	-
10	-	0921 00	37	14	-	20	-
14	-	01	-	15	-	21	-
15	-	04	-	16	-	22	-
40	-	22	40	17	-	23	-
44	-	26	37	18	-	25	-
45	-	27	-	19	-	90	-
0589 10	200	28	38	20	59	95	-
38	201	36	37	21	-	6362 02	50
0591 14	197	37	-	22	-	07	-
15	-	38	38	23	-	12	-
0592 00	196	0922 84	40	30	-	13	-
03	-	0980 03	33	31	-	17	-
07	-			50	58	25	-
09	-	4000 00		51	-	93	-
14	-	4018 53	33	52	-	94	-
16	-	4126 02	127	53	-	6423 62	108
19	-	31	120	54	-	63	-
24	-	41	-	55	-	64	-
25	-	54	-	56	-	65	-
26	-	57	-	57	-	66	-
28	-	4127 80	125	58	-	68	-
29	-	90	-	59	-		
34	-	94	-	60	-		
35	-	95	-	61	-		
43	-	4128 12	125	62	-		
47	-	13	-	63	-		
49	-	72	120	64	-		
56	-	73	-	65	-		
59	-	4130 90	116	66	-		

Enclosures

Enclosure Size (H x W x D mm)	Old Atlantic phased out items		New Atlantic-E closest equivalent	
	Cat. Nos. (without plain plate)	Status	Cat. Nos. (with plain plate)	Page No.
300 x 200 x 150	n/a	-	0399 30	14
300 x 200 x 160	0355 00	0	n/a	-
300 x 300 x 150	n/a	-	0399 31	14
300 x 300 x 160	0355 05	0	n/a	-
300 x 300 x 200	0355 30	0	0399 32	14
300 x 400 x 200	0355 01	0	0399 33	14
400 x 300 x 150	n/a	-	0399 34	14
400 x 300 x 160	0355 09	0	n/a	-
400 x 300 x 200	0355 02	0	0399 35	14
400 x 400 x 200	0355 31	0	0399 36	14
400 x 600 x 250	0355 06	0	0399 37	14
500 x 400 x 150	n/a	-	0399 38	14
500 x 400 x 200	0355 03	0	0399 39	14
500 x 400 x 250	0355 07	0	0399 40	14
500 x 500 x 250	0355 32	0	0399 41	14
600 x 400 x 200	0355 04	0	0399 42	14
600 x 400 x 250	0355 08	0	0399 43	14
600 x 500 x 200	n/a	-	0399 44	14
600 x 500 x 250	n/a	-	0399 45	14
600 x 600 x 250	0355 10	0	0399 46	14
600 x 600 x 300	0355 20	0	n/a	-
600 x 600 x 400	0355 36	0	n/a	-
600 x 800 x 300	0355 21	0	n/a	-
600 x 1000 x 300	0355 37	0	n/a	-
700 x 500 x 200	n/a	-	0399 51	14
700 x 500 x 250	0355 12	0	0399 52	14
700 x 500 x 300	0355 22	0	n/a	-
800 x 600 x 200	n/a	-	0399 54	14
800 x 600 x 250	0355 14	0	0399 55	14
800 x 600 x 300	0355 23	0	0399 56	14
800 x 600 x 400	0355 28	0	n/a	-
800 x 800 x 250	0355 15	0	n/a	-
800 x 800 x 300	0355 24	0	0399 59	14
800 x 1000 x 250	0355 33	0	n/a	-
800 x 1000 x 300	0355 34	0	n/a	-
1000 x 600 x 250	0355 17	0	n/a	-
1000 x 600 x 300	0355 26	0	0399 63	14
1000 x 800 x 250	0355 18	0	0399 64	14
1000 x 800 x 300	0355 27	0	0399 65	14
1000 x 800 x 400	0355 29	0	n/a	-
1000 x 1000 x 300	0355 91	0	n/a	-
1000 x 1200 x 300	0355 90	0	n/a	-
1200 x 800 x 300	0355 92	0	0399 69	14
1200 x 800 x 400	0355 96	0	n/a	-
1200 x 1000 x 300	0355 93	0	n/a	-
1200 x 1200 x 300	0355 94	0	n/a	-
1200 x 1200 x 400	0355 97	0	n/a	-
1400 x 800 x 400	0355 98	0	n/a	-
1400 x 1000 x 300	0355 95	0	n/a	-

Modular bell transformers and safety transformers

Old modular transformers phased out items			New modular transformers closest equivalent		
Cat. Nos.	Description	Status	Cat. Nos.	Description	Page No.
0042 20	Lexic 230/8V AC Transformer	P	4130 90	Lexic 230/8 V AC Transformer	116
0042 25	Lexic 230/12-8V AC Transformer	P	4130 91	Lexic 230/12-8V AC Transformer	116
0042 37	Lexic 230/24-12V AC Transformer	P	4130 93	Lexic 230/24-12V AC Transformer	116
0042 51	Lexic 16 VA Safety Transformer	P	4130 95	Lexic 16 VA Safety Transformer	116
0042 52	Lexic 25 VA Safety Transformer	P	4130 96	Lexic 25 VA Safety Transformer	116
0042 53	Lexic 40 VA Safety Transformer	P	4130 97	Lexic 40 VA Safety Transformer	116
0042 54	Lexic 63 VA Safety Transformer	P	4130 98	Lexic 63 VA Safety Transformer	116

Time switches

Old time switches phased out items			New time switches closest equivalent		
Cat. Nos.	Description	Status	Cat. Nos.	Description	Page No.
0047 61	AlphaRex D21 230 V	P	4126 31	AlphaRex ³ D21 230 V	120
0047 71	AlphaRex D22 230V	P	4126 41	AlphaRex ³ D22 230 V	120
0047 72/0047 81	Programming Transfer Key	P	4128 72	Programming Transfer Key	120
0047 73	Programming Software Kit	P	4128 73	Programming Software Kit	120
0047 64	AlphaRex Astro D21 230 V	P	4126 54	AlphaRex ³ Astro D21 230 V	120
0047 67	AlphaRex Astro D22 230 V	P	4126 57	AlphaRex ³ Astro D22 230 V	120
0037 30	MicroRex T11	P	4127 80	MicroRex T11	125
0037 40	MicroRex QT11	P	4127 90	MicroRex QT11	125
0037 52	MicroRex T31	P	4128 12	MicroRex T31	125
0037 53	MicroRex QT31	P	4128 13	MicroRex QT31	125
0037 44	MicroRex QW11	P	4127 94	MicroRex QW11	125
0037 55	MicroRex QW31	P	4127 95	MicroRex QW31	125
0047 02	Electronic Time-lag Switch	P	4126 02	Electronic Time-lag Switch	127

Status : P = phase out
O = obsolete

Contact details

United Kingdom

Great King Street North,
Birmingham, B19 2LF

Customer Services:

Tel: +44 (0) 845 605 4333 Fax: +44 (0) 845 605 4334
E-mail: legrand.sales@legrand.co.uk

Technical Support:

Tel: +44 (0) 870 608 9020 Fax: +44 (0) 870 608 9021
E-mail: technical.uk@legrand.co.uk

Republic of Ireland:

Tel: 01 295 9673 Fax: 01 295 4671
E-mail: legrand.sales@legrand.co.uk



FOLLOW
US AT

- @ www.legrand.co.uk
www.legrand.ie
- YouTube www.youtube.com/legrandtvuk
- voltimum www.voltimum.co.uk
www.voltimum.ie

Distributor:



Head office (UK and Ireland):
Legrand Electric Limited
Great King Street North, Birmingham, B19 2LF
Tel: +44 (0) 870 608 9000 Fax: +44 (0) 870 608 9004
Website: www.legrand.co.uk



This document is printed on sustainably sourced paper. Please recycle.

The Legrand logo is a registered trademark of the Legrand group of companies.