

HARTING Electric

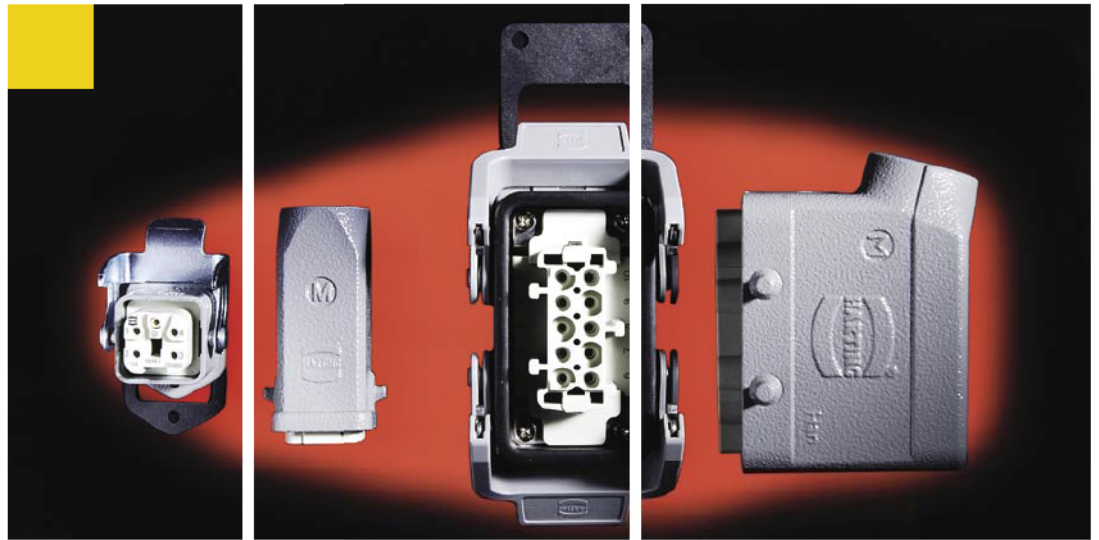

## Han-Kit® Complete Connector Sets

Industrial Connectors for Applications  
up to 500 V / 16 A

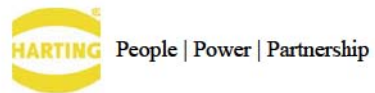

Economical and Reliable Connections - 1 Kit per Package - Easy Choice for You!

**Specifications**

VDE 0110 Table for clearance and creepage distances  
 DIN EN 61 984  
 VDE 0627 Connectors  
 Safety requirements and Tests

**Standards**

DIN EN 175 301-801

**Approvals**

UL, CSA, SEV for inserts



Certified accd. to EN ISO 9001  
 in design/ development, production,  
 installation and service.

**General Remarks:**

It is the user's responsibility to check whether the componenets belonging to these kits comply with different regulations from those stated in special fields of application which we are unable to foresee.

We reserve the right to modify designs in order to improve quality and keep pace with technological requirements in production.

No part of this information leaflet must be reproduced in any form (print, photocopy, microfilm or any other process) processed, duplicated or distributed by means of electronic systems without the written permission of HARTING ELectric GmbH & Co. KG, Espelkamp (Copyright Law, Fair Trading Law, Civil Code).

We are bound by the German version only.

**Note**

**Connectors should not be coupled or decoupled under electrical load.**

**Connectors of the same or different series being mounted side by side may be protected against incorrect mating by the use of coding options.**

**Connector Set Up**

**Han® 3 A**

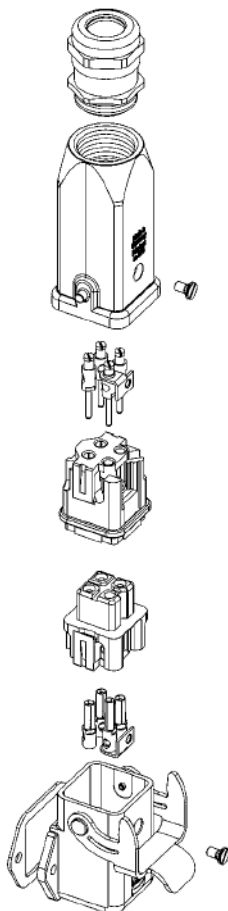

**Han® 10 B**

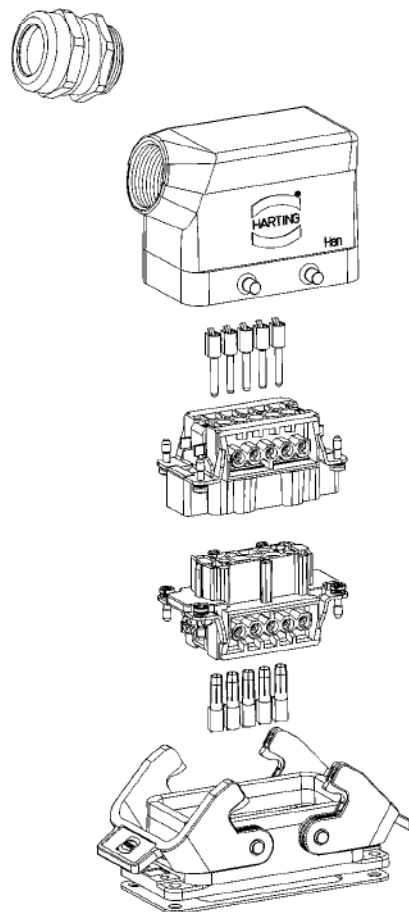

Cable Gland

Hood

Male contacts

Male insert

Female insert

Female contacts

Bulkhead mounted housing

## Screw Terminal

Inserts	Stripping length a (mm)	Sheath length x (mm)
Han 3A ... + 4A...	4.5	40
Han 10 A	7	85
Han 16 A	7	100
Han 6 E	7	70
Han 10 E	7	90
Han 16 E	7	110
Han 24 E	7	130

Recommended Tightening Torques and Screw Driver Blades				
Size of screw	Type of connector	Tightening torque [Nm]	Tightening torque [lbf·ft]	Recomm. screw driver blade [mm]
M3	Screw terminal Han 3A.../4A...	0.25	0.4	0.5 x 2.5
M3	Screw terminal Han 10A + 16A Han 6B - 24 B	0.5	0.4	0.5 x 3.5
M3.5	PE contact Han 10A + 16A	1.2	0.9	0.5 x 3.5
M4	PE contact Han 6B - 24 B	1.2	0.9	0.5 x 3.5

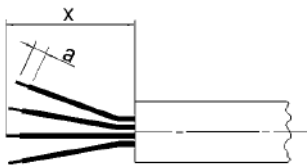

## Derating Diagrammes

The current carrying capacity is limited by the thermal properties of materials which are used for inserts as well as by the insulation materials. The rated current is the continuous, not interrupted current a connector can take when simultaneous power on all contacts is given, without exceeding the maximum temperature according to DIN IEC 60 512-3.

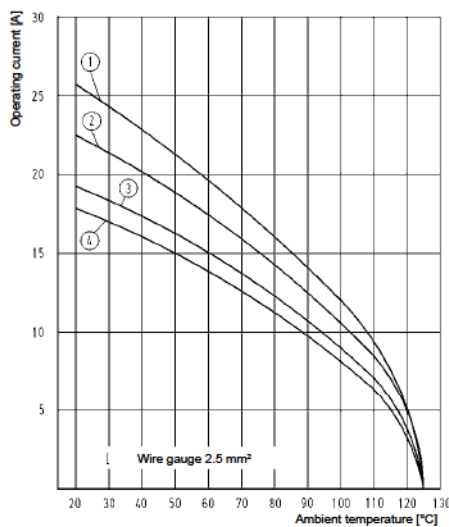

- 1 = Han 6 E
- 2 = Han 10 E
- 3 = Han 16 E
- 4 = Han 24 E

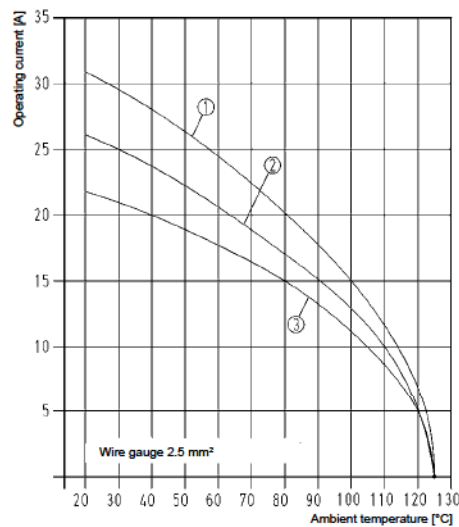

- 1 = Han 3 A / 4 A
- 2 = Han 10 A
- 3 = Han 16 A

Han® 3 A Metal Version	Part-Number	Dimensions in mm
<p><b>Han-Kit®-3AGM</b></p> <p>Hood Han® 3 A straight                      Bulkhead mounted hous.<sup>1)</sup> Han® 3 A straight                      Material Die cast zinc alloy                      Protection degree<sup>2)</sup> IP 67                      Cable gland M20, metal                      Cable diameter 5 - 9 mm / 6 - 12 mm                      Insert Han® 3 A, 3-pins + PE                      Screw terminal 1-2.5 mm<sup>2</sup>, AWG 18-14                      Electrical data accd. to DIN EN 61 984<sup>3)</sup>  <b>10 A 230/400 V 4kV 3</b></p> <p>Rated current                      Rated voltage conductor-ground                      Rated voltage conductor-conductor                      Rated impulse voltage                      Pollution degree                      Rated voltage accd. to UL/CSA 600 V</p>	<p>10 20 003 0001</p>	<p>Assembly cut out bulkhead mounted housing 22 x 22 mm</p>
<p><b>Han-Kit®-3AWM</b></p> <p>Hood Han® 3 A straight                      Bulkhead mounted hous.<sup>1)</sup> Han® 3 A angled                      Material Die cast zinc alloy                      Protection degree<sup>2)</sup> IP 67                      Cable gland M20, metal                      Cable diameter 5 - 9 mm / 6 - 12 mm                      Insert Han® 3 A, 3-pins + PE                      Screw terminal 1-2.5 mm<sup>2</sup>, AWG 18-14                      Electrical data accd. to DIN EN 61 984<sup>3)</sup>  <b>10 A 230/400 V 4kV 3</b></p> <p>Rated current                      Rated voltage conductor-ground                      Rated voltage conductor-conductor                      Rated impulse voltage                      Pollution degree                      Rated voltage accd. to UL/CSA 600 V</p>	<p>10 20 003 0003</p>	<p>Assembly cut out bulkhead mounted housing 22 x 22 mm</p>
<p><b>Han-Kit®-3AWSM</b></p> <p>Hood Han® 3 A angled                      Bulkhead mounted hous.<sup>1)</sup> Han® 3 A straight                      Material Die cast zinc alloy                      Protection degree<sup>2)</sup> IP 67                      Cable gland M20, metal                      Cable diameter 5 - 9 mm / 6 - 12 mm                      Insert Han® 3 A, 3-pins + PE                      Screw terminal 1-2.5 mm<sup>2</sup>, AWG 18-14                      Electrical data accd. to DIN EN 61 984<sup>3)</sup>  <b>10 A 230/400 V 4kV 3</b></p> <p>Rated current                      Rated voltage conductor-ground                      Rated voltage conductor-conductor                      Rated impulse voltage                      Pollution degree                      Rated voltage accd. to UL/CSA 600 V</p>	<p>10 20 003 0005</p>	<p>Assembly cut out bulkhead mounted housing 22 x 22 mm</p>

1) Bulkhead mounted housing with flange gasket  
 2) Protection degree acc. to DIN EN 60 529 in locked position  
 3) For only use in grounded circuits

**Han® 3 A** Plastic Version

Part-Number

Dimensions in mm

**Han-Kit®-3AGK**

Hood	Han® 3 A straight
Bulkhead mounted hous. <sup>1)</sup>	Han® 3 A straight
Material	Plastic
Protection degree <sup>2)</sup>	IP 67
Cable gland	M20, plastic
Cable diameter	5 - 9 mm / 6 - 12 mm
Insert	Han® 3 A, 3-pins + PE
Screw terminal	1-2.5 mm <sup>2</sup> , AWG 18-14
Electrical data accd. to DIN EN 61 984 <sup>3)</sup>	<b>10 A 230/400 V 4kV 3</b>
Rated current	
Rated voltage conductor-ground	
Rated voltage conductor-conductor	
Rated impulse voltage	
Pollution degree	
Rated voltage accd. to UL/CSA	600 V

10 20 003 0002



Assembly cut out bulkhead mounted housing 22 x 22 mm

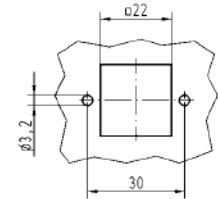

**Han-Kit®-3AWK**

Hood	Han® 3 A straight
Bulkhead mounted hous. <sup>1)</sup>	Han® 3 A angled
Material	Plastic
Protection degree <sup>2)</sup>	IP 67
Cable gland	M20, plastic
Cable diameter	5 - 9 mm / 6 - 12 mm
Insert	Han® 3 A, 3-pins + PE
Screw terminal	1-2.5 mm <sup>2</sup> , AWG 18-14
Electrical data accd. to DIN EN 61 984 <sup>3)</sup>	<b>10 A 230/400 V 4kV 3</b>
Rated current	
Rated voltage conductor-ground	
Rated voltage conductor-conductor	
Rated impulse voltage	
Pollution degree	
Rated voltage accd. to UL/CSA	600 V

10 20 003 0004



Assembly cut out bulkhead mounted housing 22 x 22 mm

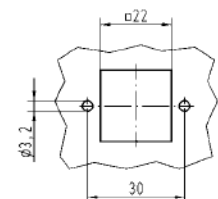

- 1) Bulkhead mounted housing with flange gasket
- 2) Protection degree acc. to DIN EN 60 529 in locked position
- 3) For only use in grounded circuits



Han® 4 A Metal Version	Part-Number	Dimensions in mm
<p><b>Han-Kit®-4AGM</b></p> <p>Hood Han® 3 A straight                      Bulkhead mounted hous.<sup>1)</sup> Han® 3 A straight                      Material Die cast zinc alloy                      Protection degree<sup>2)</sup> IP 67                      Cable gland M20, metal                      Cable diameter 5 - 9 mm / 6 - 12 mm                      Insert Han® 4 A, 4-pins + PE                      Screw terminal 1-2.5 mm<sup>2</sup>, AWG 18-14                      Electrical data accd. to DIN EN 61 984<sup>3)</sup>  <b>10 A 230/400 V 4kV 3</b></p> <p>Rated current                      Rated voltage conductor-ground                      Rated voltage conductor-conductor                      Rated impulse voltage                      Pollution degree                      Rated voltage accd. to UL/CSA 600 V</p>	<p>10 20 004 0001</p>	<p>Assembly cut out bulkhead mounted housing 22 x 22 mm</p>
<p><b>Han-Kit®-4AWM</b></p> <p>Hood Han® 3 A straight                      Bulkhead mounted hous.<sup>1)</sup> Han® 3 A angled                      Material Die cast zinc alloy                      Protection degree<sup>2)</sup> IP 67                      Cable gland M20, metal                      Cable diameter 5 - 9 mm / 6 - 12 mm                      Insert Han® 4 A, 4-pins + PE                      Screw terminal 1-2.5 mm<sup>2</sup>, AWG 18-14                      Electrical data accd. to DIN EN 61 984<sup>3)</sup>  <b>10 A 230/400 V 4kV 3</b></p> <p>Rated current                      Rated voltage conductor-ground                      Rated voltage conductor-conductor                      Rated impulse voltage                      Pollution degree                      Rated voltage accd. to UL/CSA 600 V</p>	<p>10 20 004 0003</p>	<p>Assembly cut out bulkhead mounted housing 22 x 22 mm</p>
<p><b>Han-Kit®-4AWSM</b></p> <p>Hood Han® 3 A angled                      Bulkhead mounted hous.<sup>1)</sup> Han® 3 A straight                      Material Die cast zinc alloy                      Protection degree<sup>2)</sup> IP 67                      Cable gland M20, metal                      Cable diameter 5 - 9 mm / 6 - 12 mm                      Insert Han® 4 A, 4-pins + PE                      Screw terminal 1-2.5 mm<sup>2</sup>, AWG 18-14                      Electrical data accd. to DIN EN 61 984<sup>3)</sup>  <b>10 A 230/400 V 4kV 3</b></p> <p>Rated current                      Rated voltage conductor-ground                      Rated voltage conductor-conductor                      Rated impulse voltage                      Pollution degree                      Rated voltage accd. to UL/CSA 600 V</p>	<p>10 20 004 0005</p>	<p>Assembly cut out bulkhead mounted housing 22 x 22 mm</p>

1) Bulkhead mounted housing with flange gasket  
 2) Protection degree acc. to DIN EN 60 529 in locked position  
 3) For only use in grounded circuits

**Han® 4 A** Plastic Version

Part-Number

Dimensions in mm

**Han-Kit®-4AGK**

Hood	Han® 3 A straight
Bulkhead mounted hous. <sup>1)</sup>	Han® 3 A straight
Material	Plastic
Protection degree <sup>2)</sup>	IP 67
Cable gland	M20, plastic
Cable diameter	5 - 9 mm / 6 - 12 mm
Insert	Han® 4 A, 4-pins + PE
Screw terminal	1-2.5 mm <sup>2</sup> , AWG 18-14
Electrical data accd. to DIN EN 61 984 <sup>3)</sup>	<b>10 A 230/400 V 4kV 3</b>
Rated current	
Rated voltage conductor-ground	
Rated voltage conductor-conductor	
Rated impulse voltage	
Pollution degree	
Rated voltage accd. to UL/CSA	600 V

10 20 004 0002



Assembly cut out bulkhead mounted housing 22 x 22 mm

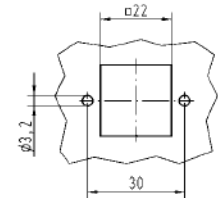

**Han-Kit®-4AWK**

Hood	Han® 3 A straight
Bulkhead mounted hous. <sup>1)</sup>	Han® 3 A angled
Material	Plastic
Protection degree <sup>2)</sup>	IP 67
Cable gland	M20, plastic
Cable diameter	5 - 9 mm / 6 - 12 mm
Insert	Han® 4 A, 4-pins + PE
Screw terminal	1-2.5 mm <sup>2</sup> , AWG 18-14
Electrical data accd. to DIN EN 61 984 <sup>3)</sup>	<b>10 A 230/400 V 4kV 3</b>
Rated current	
Rated voltage conductor-ground	
Rated voltage conductor-conductor	
Rated impulse voltage	
Pollution degree	
Rated voltage accd. to UL/CSA	600 V

10 20 004 0004



Assembly cut out bulkhead mounted housing 22 x 22 mm

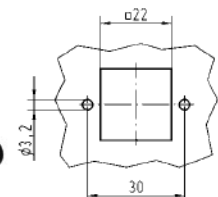

- 1) Bulkhead mounted housing with flange gasket
- 2) Protection degree acc. to DIN EN 60 529 in locked position
- 3) For only use in grounded circuits

Han® 10 A	Part-Number	Dimensions in mm
<p><b>Han-Kit®-10A</b></p> <p>Hood<sup>1)</sup> Han® 10 A                      Material Die cast aluminium alloy                      Protection degree<sup>2)</sup> IP 65                      Cable gland M20, metal                      Cable diameter 5 - 9 mm / 6 - 12 mm</p> <p>Insert Han® 10 A, 10-pins + PE                      Screw terminal 1-2.5 mm<sup>2</sup>, AWG 18-14</p> <p>Electrical data accd. to DIN EN 61 984<sup>3)</sup>  <b>16 A 250 V 4kV 3</b></p> <p>Rated current                      Rated voltage<sup>3)</sup>                      Rated impulse voltage                      Pollution degree</p> <p>Rated voltage accd. to UL/CSA 600 V</p>	<p>10 20 010 0000</p>	<p>Assembly cut out bulkhead mounted housing 57 x 24 mm</p>

Han® 16 A	Part-Number	Dimensions in mm
<p><b>Han-Kit®-16A</b></p> <p>Hood<sup>1)</sup> Han® 16 A                      Material Die cast aluminium alloy                      Protection degree<sup>2)</sup> IP 65                      Cable gland M20, metal                      Cable diameter 5 - 9 mm / 6 - 12 mm</p> <p>Insert Han® 16 A, 16-pins + PE                      Screw terminal 1-2.5 mm<sup>2</sup>, AWG 18-14</p> <p>Electrical data accd. to DIN EN 61 984<sup>3)</sup>  <b>16 A 250 V 4kV 3</b></p> <p>Rated current                      Rated voltage<sup>3)</sup>                      Rated impulse voltage                      Pollution degree</p> <p>Rated voltage accd. to UL/CSA 600 V</p>	<p>10 20 016 0000</p>	<p>Assembly cut out bulkhead mounted housing 73 x 24 mm</p>

1) Bulkhead mounted housing with flange gasket  
 2) Protection degree acc. to DIN EN 60 529 in locked position  
 3) For use in a un-grounded circuit or a grounded delta circuit



Han® 6 B

Part-Number

Dimensions in mm

**Han-Kit®-6B**

Hood<sup>1)</sup> Han® 6 B  
 Material Die cast aluminium alloy  
 Protection degree<sup>2)</sup> IP 65  
 Cable gland M20, metal  
 Cable diameter 5 - 9 mm / 6 - 12 mm

Insert Han® 6 E, 6-pins + PE  
 Screw terminal 1-2.5 mm<sup>2</sup>, AWG 18-14

Electrical data accd. to DIN EN 61 984<sup>3)</sup>  
**16 A 500 V 6kV 3**

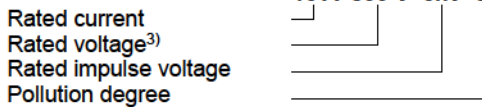

Rated voltage accd. to UL/CSA 600 V

10 33 006 0000



Dimensions in mm	Han-Kit 6 B
a	48
b	70
Assembly cut out bulkhead mounted housing	48x35

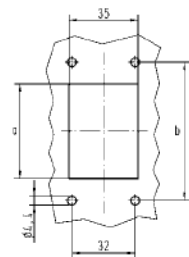

Han® 10 B

Part-Number

Dimensions in mm

**Han-Kit®-10B**

Hood<sup>1)</sup> Han® 10 B  
 Material Die cast aluminium alloy  
 Protection degree<sup>2)</sup> IP 65  
 Cable gland M25, metal  
 Cable diameter 9 - 16 mm / 13 - 18 mm

Insert Han® 10 E, 10-pins + PE  
 Screw terminal 1-2.5 mm<sup>2</sup>, AWG 18-14

Electrical data accd. to DIN EN 61 984<sup>3)</sup>  
**16 A 500 V 6kV 3**

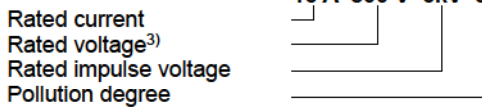

Rated voltage accd. to UL/CSA 600 V

10 33 010 0000



Dimensions in mm	Han-Kit 10 B
a	60
b	83
Assembly cut out bulkhead mounted housing	60 x 35

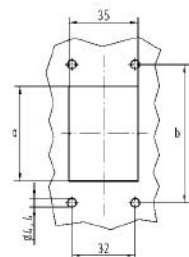

1) Bulkhead mounted housing with flange gasket  
 2) Protection degree acc. to DIN EN 60 529 in locked position  
 3) For use in a un-grounded circuit or a grounded delta circuit

**Han® 16 B**

Part-Number

Dimensions in mm

**Han-Kit®-16B**

Hood<sup>1)</sup> Han® 16 B  
 Material Die cast aluminium alloy  
 Protection degree<sup>2)</sup> IP 65  
 Cable gland M32, metal  
 Cable diameter 13-20 mm / 18-25 mm

Insert Han® 16 E, 16-pins + PE  
 Screw terminal 1-2.5 mm<sup>2</sup>, AWG 18-14

Electrical data accd. to DIN EN 61 984<sup>3)</sup>

Rated current	
Rated voltage <sup>3)</sup>	
Rated impulse voltage	
Pollution degree	

Rated voltage accd. to UL/CSA 600 V

10 33 016 0000



Dimensions in mm	Han-Kit 16 B
a	82
b	103
Assembly cut out bulkhead mounted housing	82 x 35

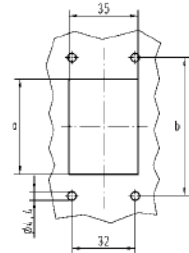

**Han® 24 B**

Part-Number

Dimensions in mm

**Han-Kit®-24B**

Hood<sup>1)</sup> Han® 24 B  
 Material Die cast aluminium alloy  
 Protection degree<sup>2)</sup> IP 65  
 Cable gland M32, metal  
 Cable diameter 13-20 mm / 18-25 mm

Insert Han® 24 E, 24-pins + PE  
 Screw terminal 1-2.5 mm<sup>2</sup>, AWG 18-14

Electrical data accd. to DIN EN 61 984<sup>3)</sup>

Rated current	
Rated voltage <sup>3)</sup>	
Rated impulse voltage	
Pollution degree	

Rated voltage accd. to UL/CSA 600 V

10 33 024 0000



Dimensions in mm	Han-Kit 24 B
a	108
b	130
Assembly cut out bulkhead mounted housing	108x35

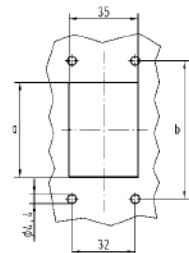

1) Bulkhead mounted housing with flange gasket  
 2) Protection degree acc. to DIN EN 60 529 in locked position  
 3) For use in a un-grounded circuit or a grounded delta circuit

Product Range



Industrial Connectors Han®



Feldbus components  
Sensor/Actuator components  
Han-InduNet® system cables

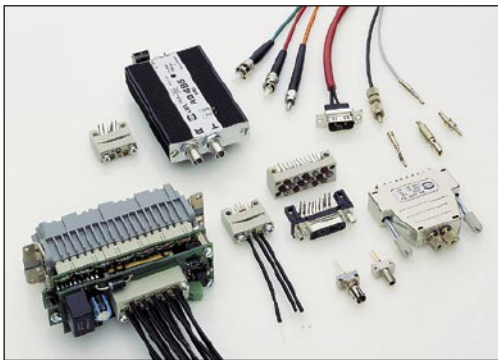

Fiber optic data link systems  
and components



Network components  
for industrial communication



## Subsidiary companies – worldwide



**Austria:** HARTING Ges. m. b. H.  
Deutschstraße 3, A-1230 Wien  
Phone +431/6162121; Fax +431/6162121-21  
E-Mail: at@HARTING.com

**Belgium:** HARTING N.V./S.A.  
Doomveld 8, B-1731 Zelkik  
Phone +322/4660190, Fax +322/4667855  
E-Mail: be@HARTING.com

**Brazil:** HARTING Ltda.  
Av. Dr. Lino de Moraes Leme, 255; Pq. Jabaquara  
CEP 04360-001 - São Paulo - SP - Brazil  
Phone +5511/5034-0073; Fax +5511/5034-4743  
E-Mail: br@HARTING.com

**China:** HARTING (HK) Limited  
Shanghai Representative Office  
Room 2302 Hong Kong Plaza South Tower  
283 Huai Hai Road (M); Shanghai 200021, China  
Phone +86 21-6390-6935, 6390-6936  
Fax +86 21-6390-6399  
E-Mail: ChinaSales@HARTING.com.cn

**Czech Republic:** HARTING spol. s.r.o.  
Mlýnská 2, 16000 Praha 6  
Phone +4202/20380450; Fax +4202/20380451  
E-Mail: HARTING@HARTING.cz  
Internet: www.HARTING.cz

**Finland:** HARTING Oy  
Hakamäenkuja 11 A, FIN-01510 Vantaa  
Phone +358 9 350 87 300, Fax +358935087320  
E-Mail: fi@HARTING.com

**France:** HARTING France, Paris Nord 2  
B.P.60058 Tremblay en France, 181, av. des Nations  
F-95972 Roissy Charles de Gaulle Cédex  
Phone +33149383400; Fax +33148632306  
E-Mail: fr@HARTING.com

**Germany:** HARTING Deutschland GmbH & Co. KG  
Simeons carré 1, D-32427 Minden  
Phone +49571/8896-0; Fax +49571/8896-282  
E-Mail: de.sales@HARTING.com

**Great Britain:** HARTING Ltd.  
Caswell Road, Brackmills Industrial Estate  
GB-Northampton, NN4 7PW  
Phone +441604/766686, 827500; Fax +441604/706777  
E-Mail: gb@HARTING.com  
Internet: www.HARTING.co.uk

**Hong Kong:** HARTING (HK) Limited  
Regional Office Asia Pacific  
4208 Metropiaza Tower 1, 223 Hing Fong Road  
Kwai Fong, N. T., Hong Kong  
Phone +852/2423-7338, Fax +852/2480-4378  
E-Mail: AsiaPacific@HARTING.com.hk

**Italy:** HARTING SpA  
Via Dell' Industria 7  
I-20090 Vimodrone (Milano)  
Phone +3902/250801, Fax +3902/2650597  
E-Mail: it@HARTING.com

**Japan:** HARTING K. K.  
Yusen Shin-Yokohama 1 Chome Bldg., 2F  
1-7-9, Shin-Yokohama, Kohoku-ku, Yokohama  
222-0033 Japan  
Tel: +81 45 476 3456; Fax: +81 45 476 3466  
E-Mail: JapanSales@HARTING.com  
Internet: www.HARTING.co.jp

**Korea:** HARTING Korea Limited  
14/F FKI Building, 28-1 Yoido-dong  
Youngdungpo-Gu, Seoul 150-756, Korea  
Phone +82 2-784-4614, 784-4615  
Fax +82 2-3776-0070  
E-Mail: KoreaSales@HARTING.co.kr

**Netherlands:** HARTING B.V.  
Larenweg 44, NL-5234 KA, s-Hertogenbosch  
Postbus 3526, NL-5203 DM, s-Hertogenbosch  
Phone +3173/6410404; Fax +3173/6440699  
E-Mail: verkoop.nl@HARTING.com

**Norway:** HARTING A/S  
Østlensjøveien 36, N-0667 Oslo  
Phone +4722/700555; Fax +4722/700570  
E-Mail: no@HARTING.com

**Portugal:** HARTING Iberia S.A.  
Josep Tarradellas 20-30 4<sup>a</sup> 6<sup>a</sup>; E-08029 Barcelona  
Phone +34 933 638 475; Fax +34 934 199 585  
E-Mail: es@HARTING.com

**Russia:** HARTING ZAO  
ul. Tobolskaja 12  
Saint Petersburg, 194044 Russia  
Phone +7/812/3276477; Fax +7/812/3276478  
E-Mail: info@HARTING.ru  
Internet: www.HARTING.ru

**Singapore:** HARTING Singapore Pte Ltd.  
No. 1 Coleman Street, #B1-21 The Adelphi  
Singapore 179803  
Phone +6562255285, Fax +6562259947  
E-Mail: SEAsiaSales@HARTING.com.my

**Spain:** HARTING Iberia S.A.  
Josep Tarradellas 20-30 4<sup>a</sup> 6<sup>a</sup>; E-08029 Barcelona  
Phone +34 933 638 475; Fax +34 934 199 585  
E-Mail: es@HARTING.com

**Sweden:** HARTING AB  
Gustavslundvägen 141B; S-16751 Bromma  
Phone +468/4457171; Fax +468/4457170  
E-Mail: se@HARTING.com

**Switzerland:** HARTING AG  
Industriestrasse 26, CH-8604 Volketswil  
Phone +4119082060, Fax +4119082069  
E-Mail: ch.zh@HARTING.com

**Taiwan:** HARTING R.O.C. Limited  
Room 6, 10 Floor, No. 171  
Sung-Te Road, Taipei, Taiwan  
Phone +886-2-2346-3177; Fax +886-2-2346-2690  
E-Mail: TaiwanSales@HARTING.com.tw

**USA:** HARTING Inc. of North America  
1370 Bowes Road; Elgin, Illinois 60123  
Phone +1 847 / 741 1500  
Fax +1 847 / 741 8257 (Customer Service)  
Fax +1 847 / 717 9420 (Sales+Marketing)  
E-Mail: more.info@HARTING.com  
Internet: www.HARTING-USA.com

**Eastern Europe**  
HARTING Eastern Europe GmbH  
Marienwerderstraße 3, D-32339 Espelkamp  
Phone +495772/47-802; Fax +495772/47-90 802  
E-Mail: eastern.europe@HARTING.com

**Other countries**  
Please contact your Global Business Unit

## Global Business Unit Electric



**HARTING Electric GmbH & Co. KG**  
P.O. Box 1473  
D-32328 Espelkamp  
Phone +49 57 72/47-97 100  
Fax +49 57 72/47-495  
E-Mail: HARTING.electric@HARTING.com  
Internet: www.HARTING.com

## Representatives – worldwide



**Argentina:** Condel Electronica  
Julian Agüero 3355  
(1605) Munro - Pcia. de Buenos Aires  
Phone + Fax +54 11 4762.0118  
E-Mail: mediavicondel@arnet.com.ar  
Roberto Mediavilla  
Rivera Indarte 390; (5000) Córdoba  
Phone +54 351 425-0567, Fax +54 351 421-2282  
E-Mail: rmediavilla@arnet.com.ar

**Australia**  
ADILAM Electronics Pty. Ltd.  
14 Nicole Close, North Bayswater  
3153 Victoria  
Phone +61 3 9737 4900  
Fax +61 3 9737 4999  
E-Mail: mark.c@adilam.com.au  
Internet: www.adilam.com.au

**Denmark:** Knud Wexøe A/S  
Skaettekaeret 11, P.O. Box 152  
DK-2840 Holte  
Phone +45 45 46 58 00, Fax +45 45 46 58 01  
wexoe@wexoe.dk; www.wexoe.dk

**Finland:** SKS-automaatio OY  
Martinkyläntie 50, FIN-01721 Vantaa  
Phone +358 9 852 661, Fax +358 9 852 68 20  
E-Mail: automaatio@skss.fi

**Estonia:** SKS-tehnika Ou  
Mustamäe tee 55; EE-10621 Tallinn  
Phone +372-6819-234, Fax +372-6819-235  
peeter.kuus@skss.fi

**Hungary:** Mile Kft.  
Mádi u. 52; H-1104 Budapest  
Phone +36-1-431-9800, Fax +36-1-431-9817  
milekft@mile-kft.hu; www.mile-kft.hu

**India:** Sahajanand Impex Pvt. Ltd.  
103/ 104, Magnum Opus  
Shantinagar, Vakola Santacruz (East)  
Mumbai - 400 055, INDIA  
Phone +91-22-5692 5151  
Fax +91-22-5692 1026  
E-Mail: sales@sahajanand.com  
Internet: www.sahajanand.com

**Iceland:** Smith & Norland  
Nóatún 4; IS-105 Reykjavík  
Phone +354 520 3000, Fax +354 520 3011  
olaf@smminor.is; www.smminor.is

**Polen:** Soyter Sp. z o. o.  
ul. Warszawska 3  
05-082 Warszawa - Stare Babice  
Phone +48 22 722 0 685  
Fax +48 22 722 0 550  
handlowy@soyter.com.pl; www.soyter.com

**South-Africa**  
HellermannTyton Pty Ltd.  
Private Bag X158 Rivonia 2128  
34 Milky Way Avenue  
Linbro Business Park 2065  
Johannesburg, South Africa  
Phone +27 (0)11 879-6600  
Fax +27 (0)11 879-6606  
E-Mail: sales.jhb@hellermann.co.za

**Turkey**  
Gökhan Elektrik San. Tic. Ltd. Sti.  
Perpa Elektrikçiler İş Merkezi A Blok  
Kat:7-8-9 No.694  
TR - 80270 Okmeydanı/Istanbul  
Phone +90 (212) 221 32 36 (pbx)  
Fax +90 (212) 221 32 40  
E-Mail: gokhan@gokhanelektrik.com

## Your Contact Partner

