

Fast Switching SCR T72H_48

475A Avg.
(750 RMS)
Up to 800 Volts
20-40 μ s

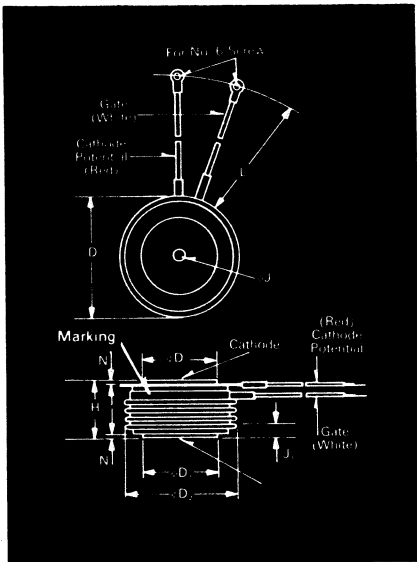

Symbol	Inches		Millimeters	
	Min.	Max.	Min.	Max.
ϕD	2.250	2.290	57.15	58.17
ϕD_1	1.333	1.343	33.86	34.11
ϕD_2	2.030	2.090	51.56	53.09
H	1.020	1.060	25.91	26.92
ϕJ	.135	.145	3.43	3.68
J_1	.075	.090	1.91	2.29
L	7.75	8.50	196.85	215.90
N	.040		1.02	

Creep Distance—1.00 in. min. (25.40 mm).
Strike Distance—.69 in. min. (17.53 mm).
(In accordance with NEMA standards.)
Finish—Nickel Plate.
Approx. Weight—8 oz. (227 g).
1. Dimension "H" is a clamped dimension.

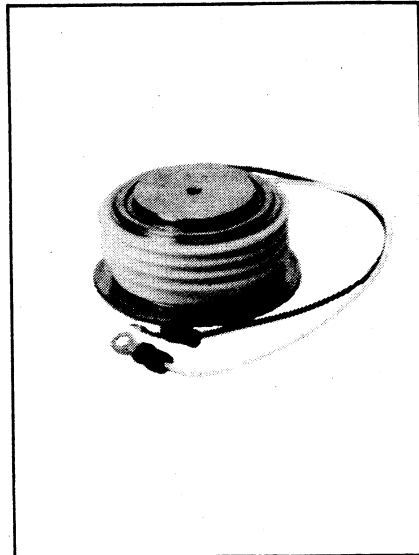

T72 Outline

Features:

- Interdigitated, di/namic Gate structure
- Hard Commutation Turn-Off
- Forward Blocking Voltage Capabilities to 800 Volts
- Low Switching Losses at High Frequency
- Soft Commutation (Feedback Diode) Testing Available
- High di/dt with soft gate control

Applications:

- Induction Heating
- Transportation
- Inverters

Ordering Information

Type	Voltage		Current		Turn-off		Gate current		Leads	
	VDRM and VRRM (V)	Code	I _{T(av)} (A)	Code	t _q usec	Code	I _{GT} (ma)	Code	Case	Code
T72H	100	01	475	48	20	6	150	4	T72	DN
	200	02								
	300	03								
	400	04								
	500	05								
	600	06								
	700	07								
	800	08								

Example

Obtain optimum device performance for your application by selecting proper Order Code.

Type T72H rated at 475 A average with V_{DRM} = 400V
I_{GT} = 150 ma, t_q = 30 μ sec max. and leads—order as:

Type	Voltage	Current	Turn Off	Gate Current	Leads
T 7 2 H	0 4	4 8	5	4	D N

475A Avg.
(750 RMS)
Up to 800 Volts
20-40 μ s

Fast Switching
SCR
T72H_48

Voltage ①

Blocking State Maximums ($T_J = 125^\circ\text{C}$)

Symbol	100	200	300	400	500	600	700	800
Repetitive peak forward blocking voltage, V V_{DRM}	100	200	300	400	500	600	700	800
Repetitive peak reverse voltage, V V_{RRM}	100	200	300	400	500	600	700	800
Non-repetitive transient peak reverse voltage, $t \leq 5.0$ msec, V V_{RSM}	200	300	400	500	600	700	800	900
Forward leakage current, mA peak I_{DRM}	← 35 →							
Reverse leakage current, mA peak I_{RRM}	← 35 →							

Current

Conducting State Maximums ($T_J = 125^\circ\text{C}$)

Symbol	T72H_48
RMS forward current, A $I_T(rms)$	750
Ave. forward current, A $I_T(av)$	475
One-half cycle surge current ^② , A I_{TSM}	8000
I^2t for fusing (for times ≥ 8.3 ms) I^2t , A ² sec.	265,000
Forward voltage drop at $I_{TM} = 1500A$ and $T_J = 25^\circ\text{C}$, V V_{TM}	1.55
Min. repetitive di/dt ③④⑤ A/ μ sec di/dt	600

Switching

($T_J = 25^\circ\text{C}$)

Symbol	
Max. turn-off time, $I_T = 400A$, $T_J = 125^\circ\text{C}$ $t_p = 100 \mu\text{sec}$, $dirR/dt = 25$ A/ μ sec., reappplied $dv/dt = 200V/\mu\text{sec}$. linear to 0.8 V_{DRM} , μsec . ③④ t_q	20 to 40
Typ. delay time, $I_{TM} = 1000A$ $T_D = .8 V_{DRM}$, μsec t_d	.5
Typ turn-on-time $I_{TM} = 1000A$, μsec t_{on}	3.0
Min. critical dv/dt exponential to .8 V_{DRM} , $T_J = 125^\circ\text{C}$, V/ μ sec ③④ dv/dt	300
Min. di/dt , non-repetitive, A/ μ sec ③④⑤ di/dt	1200

Gate

Maximum Parameters ($T_J = 25^\circ\text{C}$)

Symbol	
Gate current to trigger at $V_D = 12V$, mA I_{GT}	150
Gate voltage to trigger at $V_D = 12V$, V V_{GT}	3
Non-triggering gate voltage, $T_J = 125^\circ\text{C}$, and rated V_{DRM} , V V_{GDM}	.25
Peak forward gate current, A I_{GTM}	4
Peak reverse gate voltage, V V_{GRM}	5
Peak gate power, Watts P_{GM}	16
Average gate power, Watts $P_{G(av)}$	3

Thermal and Mechanical

Symbol	
Min., Max. oper. junction temp., $^\circ\text{C}$ T_J	-40 to +125
Min., Max. storage temp., $^\circ\text{C}$ T_{stg}	-40 to +150
Max. mounting force, lb. ①	2000 to 2400
Thermal resistance ^① , double-side cooling, junction to case, $^\circ\text{C}/\text{Watt}$ $R_{\theta JC}$.06
Case to sink, lubricated, $^\circ\text{C}/\text{Watt}$ $R_{\theta CS}$.02

- ① Consult recommended mounting procedures.
- ② Applies for zero or negative gate bias.
- ③ Per JEDEC RS-397, 5.2.2.1.
- ④ With recommended gate drive.
- ⑤ Higher dv/dt ratings available, consult factory.
- ⑥ Per JEDEC standard RS-397, 5.2.2.6.
- ⑦ For operation with antiparallel diode, consult factory.

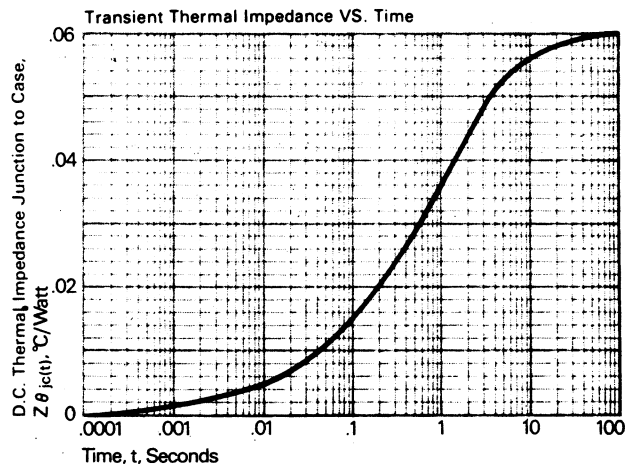
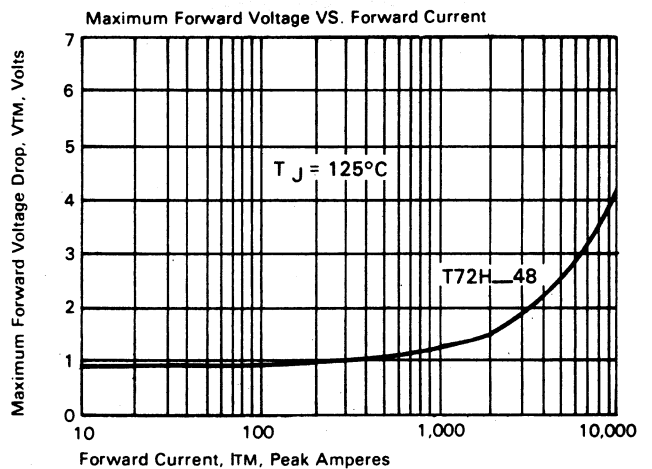

FAST SWITCHING THYRISTORS

Fast Switching SCR T72H_48

475A Avg.
(750 RMS)
Up to 800 Volts
20-40 μ s

Sinusoidal Current Data

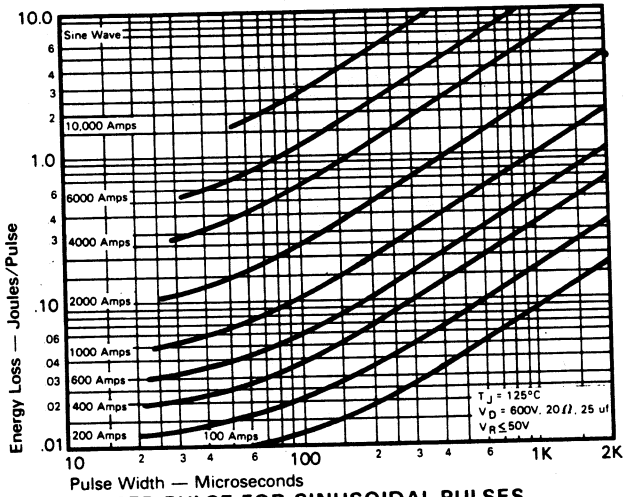

Trapezoidal Wave Current Data

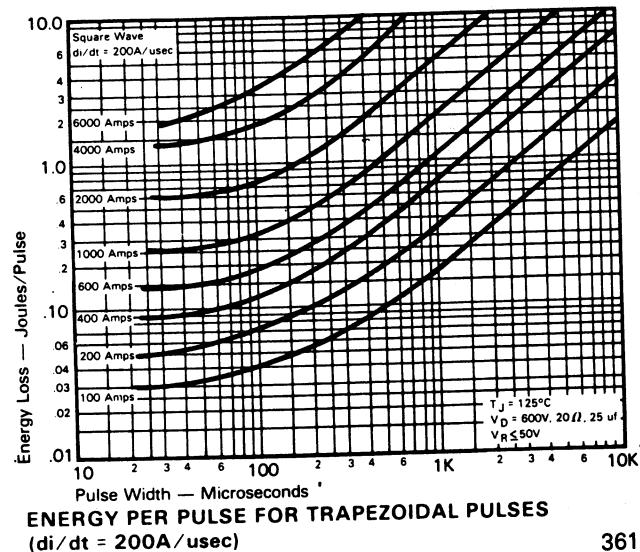
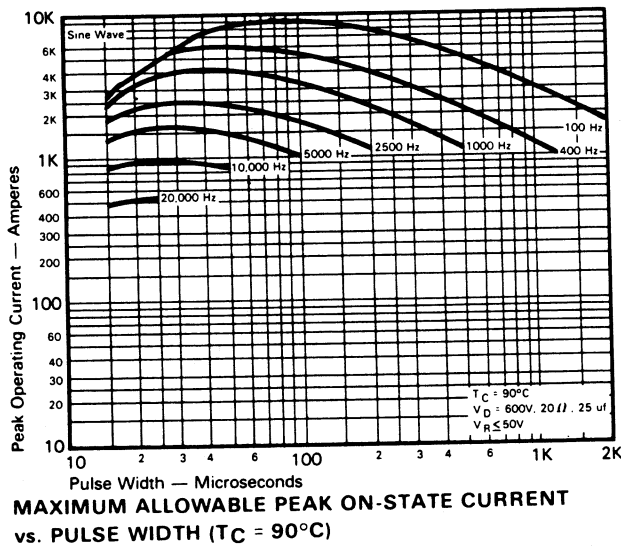
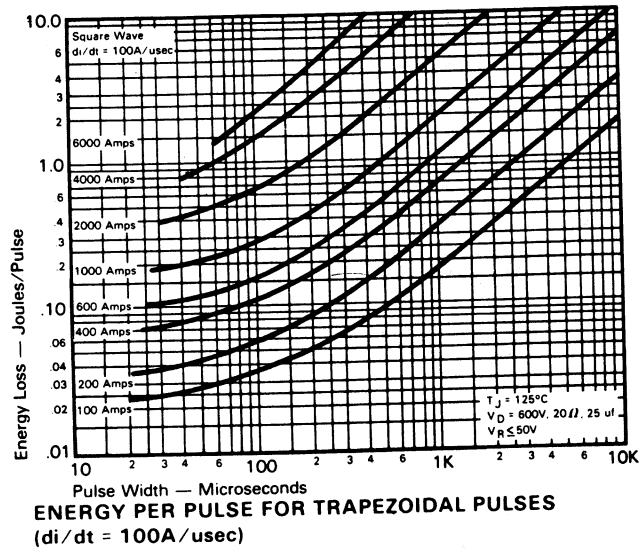
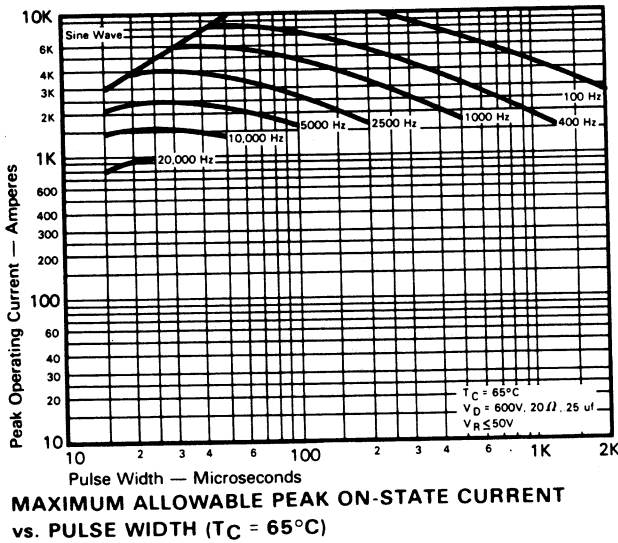
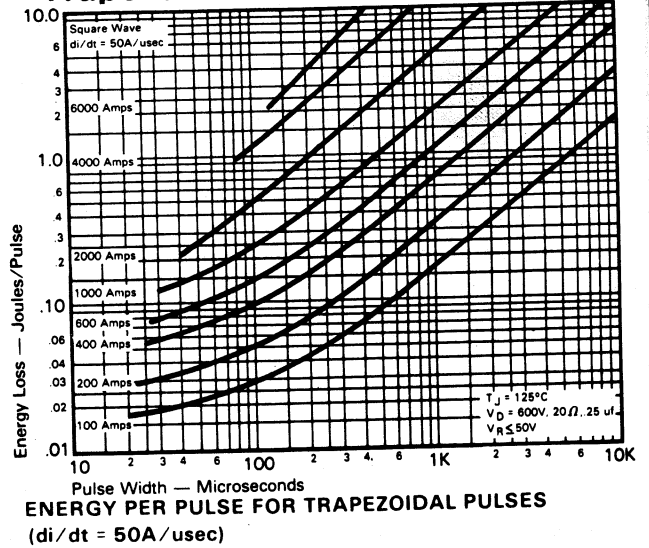

475A Avg.
(750 RMS)
Up to 800 Volts
20-40 μ s

Fast Switching
SCR
T72H_48

Trapezoidal Wave Current Data
($T_C = 65^\circ\text{C}$)

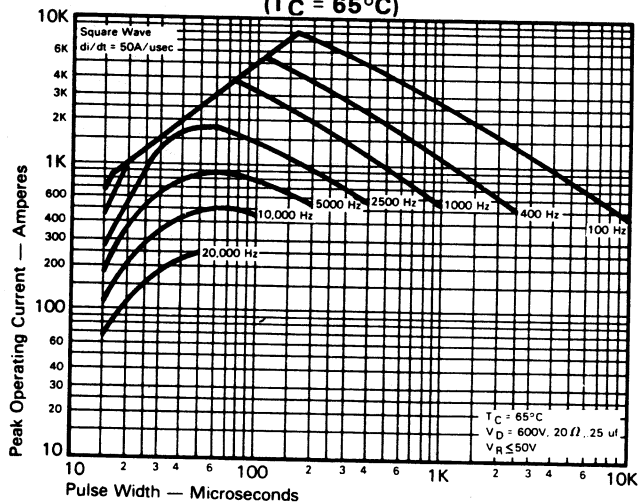

MAXIMUM ALLOWABLE PEAK ON-STATE CURRENT vs. PULSE WIDTH ($di/dt = 50A/usec$)

Trapezoidal Wave Current Data
($T_C = 90^\circ\text{C}$)

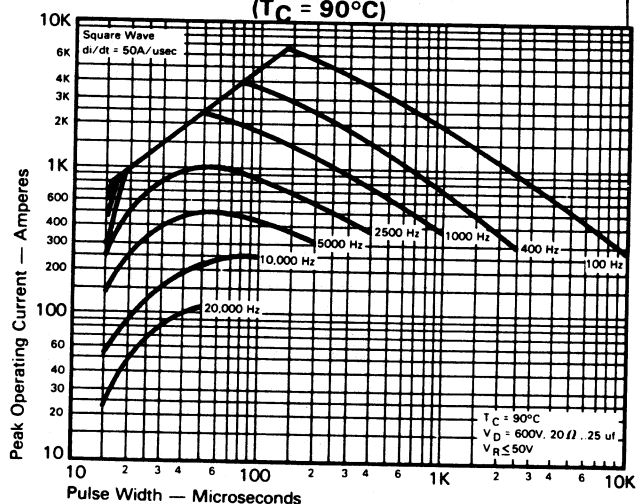

MAXIMUM ALLOWABLE PEAK ON-STATE CURRENT vs. PULSE WIDTH ($di/dt = 50A/usec$)

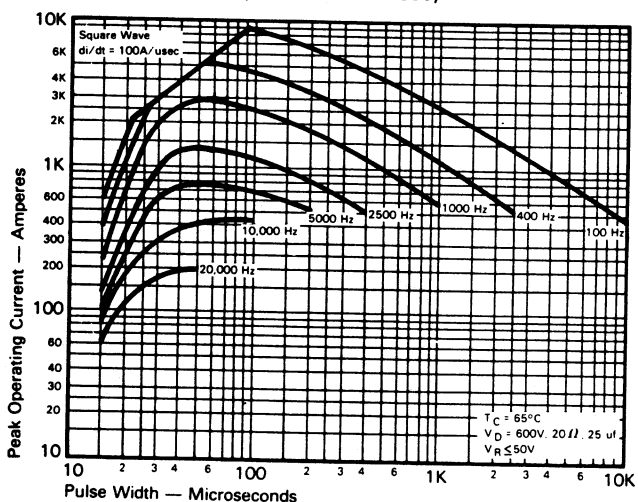

MAXIMUM ALLOWABLE PEAK ON-STATE CURRENT vs. PULSE WIDTH ($di/dt = 100A/usec$)

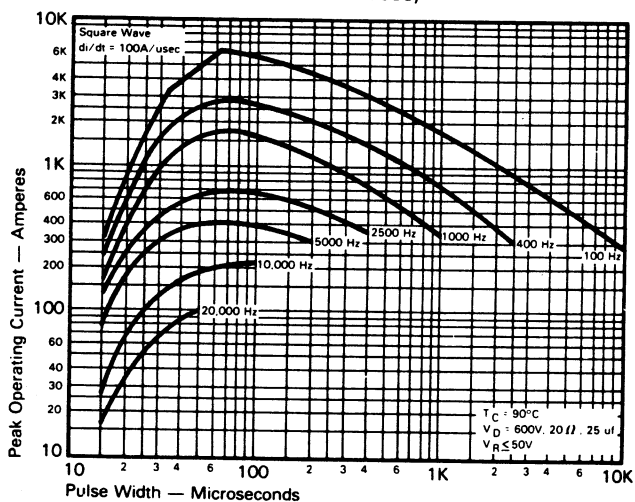

MAXIMUM ALLOWABLE PEAK ON-STATE CURRENT vs. PULSE WIDTH ($di/dt = 100A/usec$)

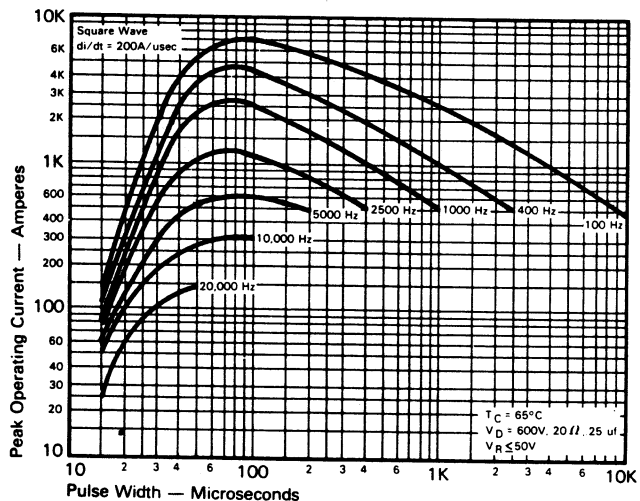

MAXIMUM ALLOWABLE PEAK ON-STATE CURRENT vs. PULSE WIDTH ($di/dt = 200A/usec$)

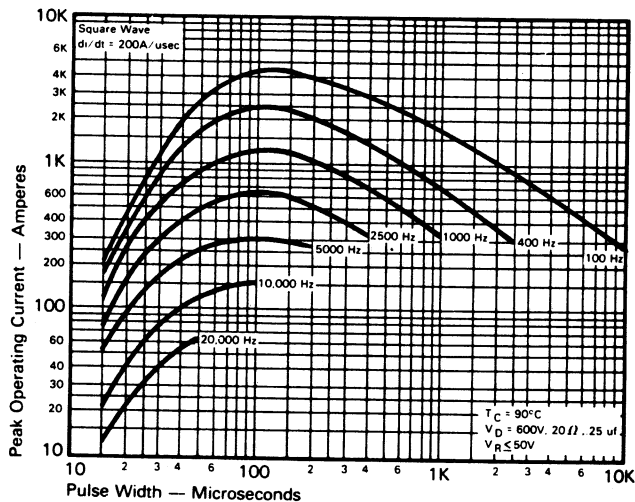

MAXIMUM ALLOWABLE PEAK ON-STATE CURRENT vs. PULSE WIDTH ($di/dt = 200A/usec$)

FAST SWITCHING THYRISTORS