

SMD versión available (PS-10)

MECHANICAL SPECIFICATIONS

- Mechanical rotation angle: $235^\circ \pm 5^\circ$
- Electrical rotation angle: $220^\circ \pm 20^\circ$
- Torque: 0.4 to 2 Ncm. (0.6 to 2.7 in-oz)
- Stop torque: > 5 Ncm. (>7 in-oz)
- Life(*): Up to 10K cycles

FEATURES

- Carbon resistive element
- IP54 protection according to IEC 60529
- Polyester substrate
- Also upon request:
 - Wiper positioned at 50% or fully clockwise.
 - Supplied in magazines for automatic insertion.
 - Long life model for low cost control potentiometer applications
 - Self extinguishable plastic UL 94V-0
 - Cut track option
 - Special tapers
 - Mechanical detents
 - Low torque version
 - Special switch option
 - 3% Linearity and 100K cycles mechanical life

ELECTRICAL SPECIFICATIONS

- Range of values (*) $100\Omega \leq R_n \leq 5\text{ M}$ (Decad. 1.0 - 2.0 - 2.2 - 2.5 - 4.7 - 5.0)
- Tolerance (*): $100\Omega \leq R_n \leq 1\text{M}\Omega$ $\pm 20\%$
 $1\text{M}\Omega < R_n \leq 5\text{M}\Omega$ $\pm 30\%$
- Max. Voltage: 200 VDC (lin) 100 VDC (no lin)
- Nominal Power 50°C (122°F) (see power rating curve)
 0.15 W (lin) 0.07 W (no lin)
- Taper (*) (Log. & Alog. only R_n 1K) Lin ; Log; Alog.
- Residual resistance(*): $\leq 0.5\%$ R_n (5 Ω min.)
- Equivalent Noise Resistance: $\leq 3\%$ R_n (3 Ω min.)
- Operating temperature(**): $-25^\circ\text{C} + 70^\circ\text{C}$ ($-13^\circ\text{F} + 158^\circ\text{F}$)

(*) Others upon request (**) Up to 85°C depending on application

HOW TO ORDER

PT 10		L	H01	101	A	2020	OPTIONAL EXTRAS				S	
Series	PT-10		Code	Mounting Method	Taper	Life	Detents	Shaft/Thum.	Shaft/rotor colour	Torque		
Rotors	B G K L M R W X Y Z		H01 H05 H02 H10 V05 V10 V11 V13	H2.5 H5 H2.5P H5P V5 VP VJ	A = Lin. B = Log. C = Alog.	E = Long life (See note 5)	PAI PAM PAF P11 P1F P02 : P16	01 = Fig. 1 02 = Fig. 2 : 17 = Fig. 17 (See note 10)	RO = Red NE = Black VE = Green AM = Yellow AZ = Blue MA = Brown GR = Grey NA = Orange CR = Cream (See note 8)	- = Standard L = Low Torque (See note 9)		
			(See note 2 / SMD version available: see product PS-10)					Cut track	Magazine	Flammability	Wiper position	
				Value		Tolerance		PCI = Initial PCF = Final	T	I = Non flammable (See note 7)	PM = 50% PF = Final	
				101 = 100 Ω : 504 = 500 K : 505 = 5 M 000 = CM (See note 3)		2020 = $\pm 20\%$ 3030 = $\pm 30\%$ (See note 4)						

NOTES:

- "Z" adjustment only available on "H" versions. Rotor "G" only available in purple (shaft/rotor colour "VI").
- Terminals styles: "P" & "J" are crimped. V=Vertical adjust; H=Horizontal Adjust
- Value Example: Code: $\overset{10}{\text{10}} \overset{1}{\text{1}} \text{100 } \Omega$
 → Numb of zeros
 → First two digits of the value.
 000 = CM = Switch version (contact us)
- Non standard tolerance, upon request. Example: +7% Code: 07 05
 -5% → negative tolerance
 → positive tolerance
- Standard = 500 cycles • Long = 10K cycles
 Others upon request.
- Magazines: not available with the H10, V05 and V13 models, nor with adjustment types X, W, Y, Z.
- Non flammable: housing, rotor and shaft. According to UL 94V-0
- Colour shaft/rotor:
 - Potentiometer without shaft: only rotor
 - Potentiometer with shaft: only shaft
 - Cream colour only available in standard plastic.
- Low Torque: $\leq 1\text{ Ncm}$
 No detent option available for low torque models.
- If you wish to use your own custom plastic shaft/knob/actuator please contact Piher for advice about compatible materials.

NOTE: The information contained here should be used for reference purposes only.

HOW TO ORDER CUSTOM DRAWING

PT-10 LH 01 + DRAWING NUMBER (Max. 16 characters)

This way of ordering should be used for options which are not included in the "How to order" standard and optional extras.

STANDARD OPTIONS

Cut track	-----	No
Detents	-----	None
Packing	-----	Bulk
Non flammable	-----	No
Rotor colour	-----	White
Shaft colour	-----	Natural
Wiper position	-----	Initial
Torque	-----	Standard
Life	-----	500 cycles

ROTORS

Without shaft

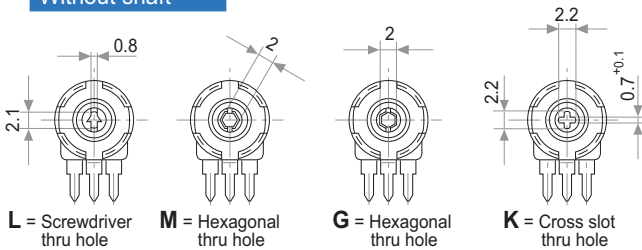

Wipers positioned at 50%

With shaft

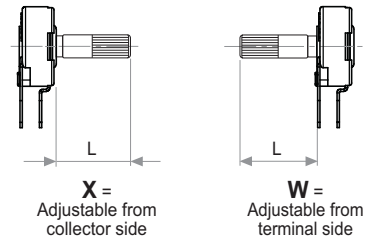

With thumbwheel

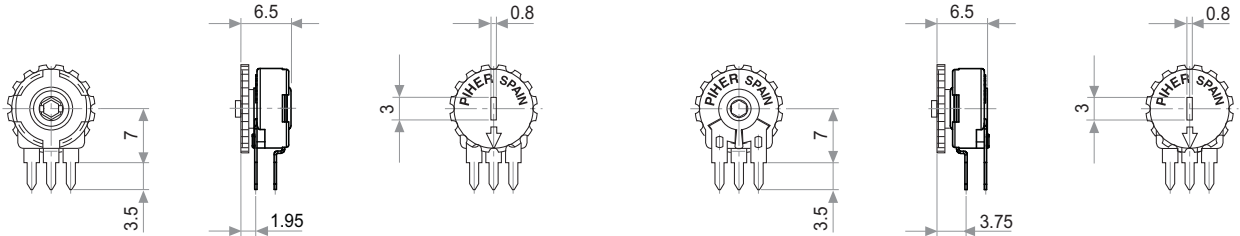

MOUNTING METHODS

v = horizontal mount – vertical adjust

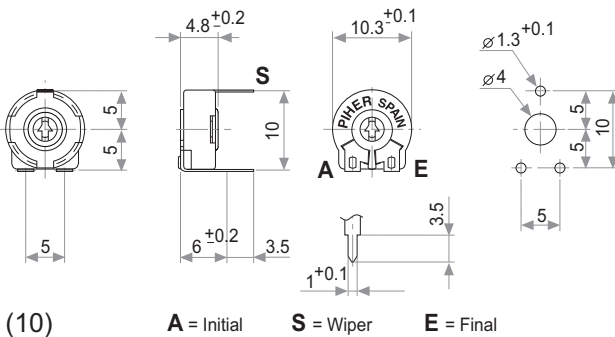

h = vertical mount – horizontal adjust

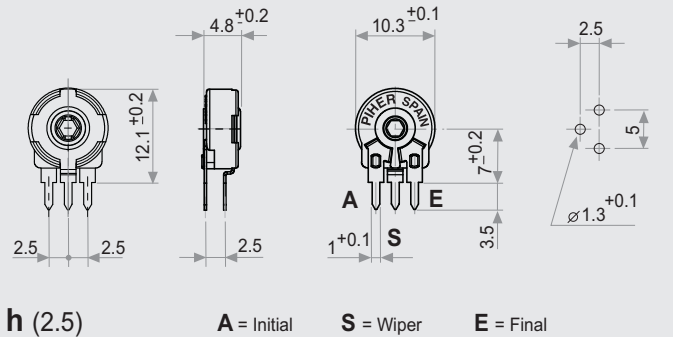

NOTE = Please note relative terminal positions when ordering non linear tapers.

Crimped terminals

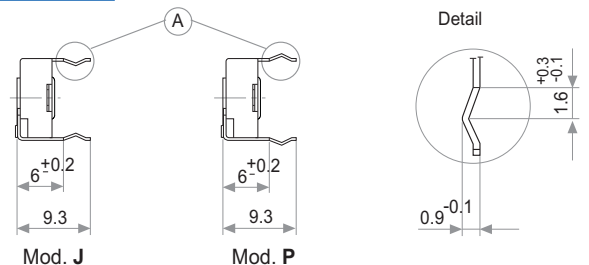

OPTIONS

Positioning (Std. Position = CCW)

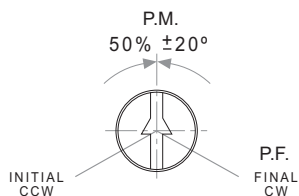

CUT TRACK
CCW on-off (A)

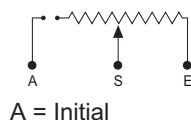
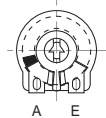

A = Initial

E = Final

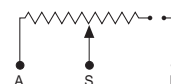

S = Wiper

CW on-off (E)

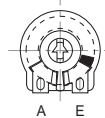

TAPERS

Standard

A = Linear
B = Log.
C = Alog.

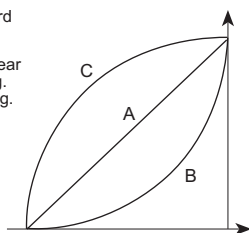

Special taper example

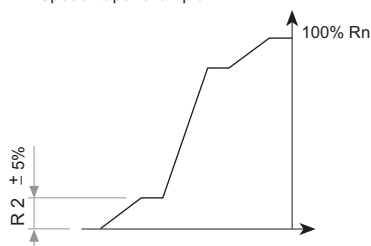

NOTE = Please note relative terminal positions when ordering non linear tapers.

TESTS

TYPICAL VARIATIONS

ELECTRICAL LIFE	1.000 h. @ 50°C; 0.15 W	±5 %
MECHANICAL LIFE (CYCLES)	500 @ 10 CPM ... 15 CPM	±3 % (Rn < 1 MΩ)
TEMPERATURE COEFFICIENT	-25°C; +70°C	±300 ppm (Rn < 100 K)
THERMAL CYCLING	16 h. @ 85°C; 2h. @ -25°C	±2.5 %
DAMP HEAT	500 h. @ 40°C @ 95% HR	±5 %
VIBRATION (for each plane X,Y,Z)	2 h. @ 10 Hz. ... 55 Hz.	±2 %

NOTE: Out of range values may not comply these results.

PACKAGING

BOXES

Model	Units
Without shaft	1000 (80 x 85 x 185 mm.)
With thumbwheel	800 (80 x 85 x 185 mm.)
With shaft	400 (80 x 85 x 185 mm.)

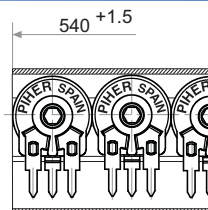
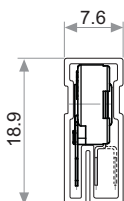

Magazines for PT-10 h 2.5; h 5

Also crimped term. h 2.5 P

AUTOMATIC INSERTION

Magazines	Units per magazine
PT-10H & PT-10V	50 Pieces

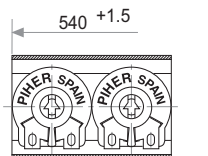
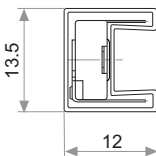

Magazines for PT-10 V

Also crimped term. VP

RECOMMENDED CONNECTION

Recommended connection scheme for Piher's position sensors (voltage divider)

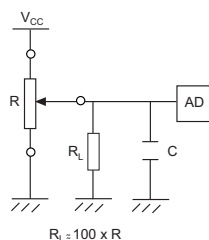

POWER RATING CURVE

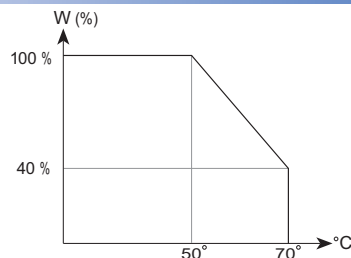

SHAFTS (for G and M rotor types, top view)

Shafts, knobs & thumbwheels are delivered at random position. Positioning available upon request.

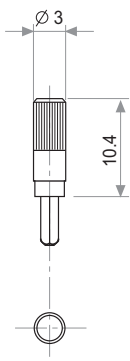

Fig. 1 / Ref. 5016

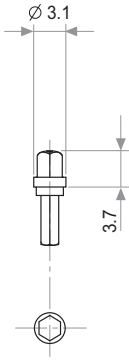

Fig. 2 / Ref. 5053

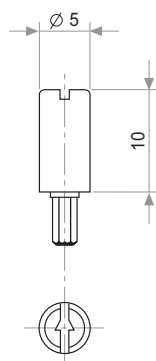

Fig. 3 / Ref. 5012

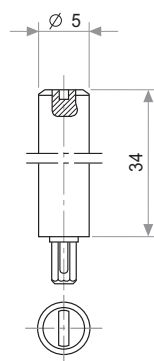

Fig. 4 / Ref. 6053

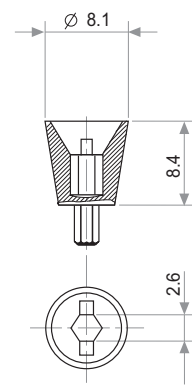

Fig. 6 / Ref. 5035

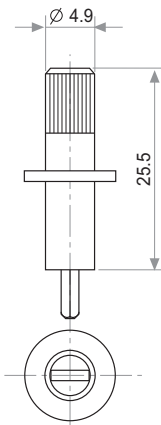

Fig. 7 / Ref. 5115

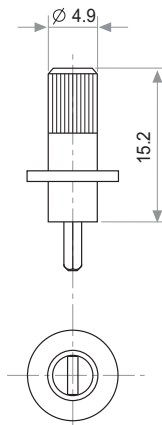

Fig. 8 / Ref. 5116

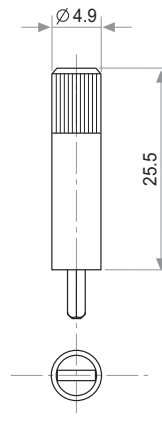

Fig. 9 / Ref. 5119

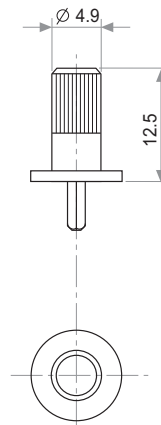

Fig. 10 / Ref. 5120

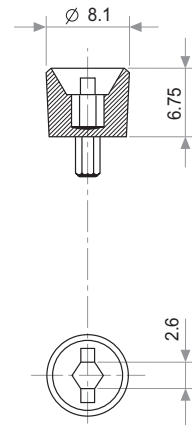

Fig. 11 / Ref. 5027

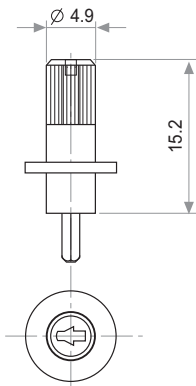

Fig. 12 / Ref. 6052

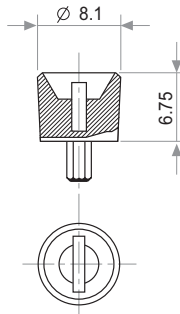

Fig. 13 / Ref. 5121

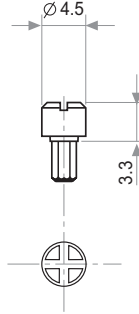

Fig. 14 / Ref. 5055

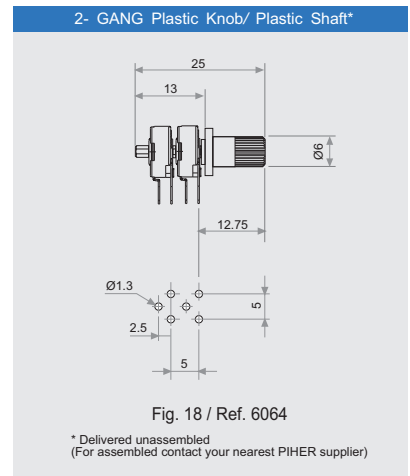

Fig. 18 / Ref. 6064

* Delivered unassembled
(For assembled contact your nearest PIHER supplier)

THUMBWHEELS (for G and M rotor types, top view)

Shafts, knobs & thumbwheels are delivered at random position. Positioning available upon request.

THUMBWHEEL

For R rotor type only

Marking: configurable number of positions.

Example of four positions marking:

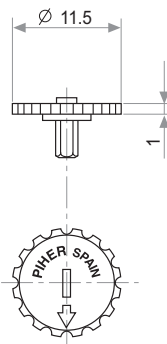

Fig. 5 / Ref. 5034

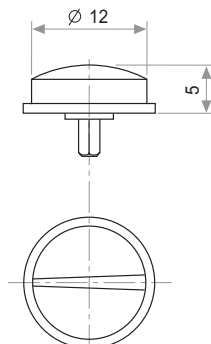

Fig. 15 / Ref. 6008

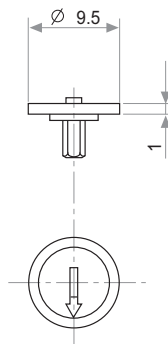

Fig. 16 / Ref. 5039

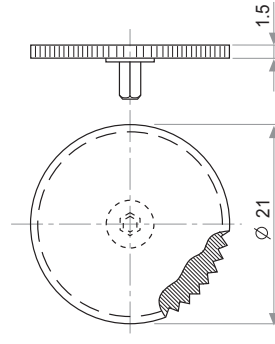
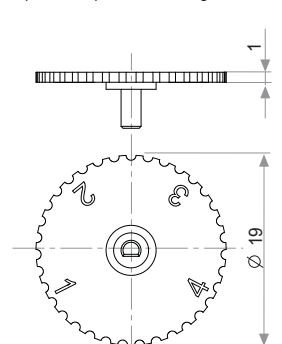

Fig. 17 / Ref. 5062



Upon request

DETENT CONFIGURATIONS EXAMPLES

This innovative PT's with detents family has been specifically developed to allow the integration of otherwise large and expensive external mechanisms into the body of the majority of the 10 & 15 mm. PS/PT/PTC potentiometer series thus allowing a high range of configurations: special tapers, torque, tolerances, linearity, cut track, etc.

This detent design not only adds a "click" sensation of position, but also offers enormous savings in both cost and space for any given application.

Strong and weak detents can be mixed as per customer's request.

Detent number and positions can be made or fitted to the customer needs or preferences.

- Relative detent positions along the total mechanical travel. Unless otherwise specified the detents are evenly spaced (using the end points as reference)

*For more than 10 detents versions please contact your nearest PIHER distributor. Mechanical and/or electrical features may be affected by detents. Please see our separate PTs with detents datasheet at www.pihernet

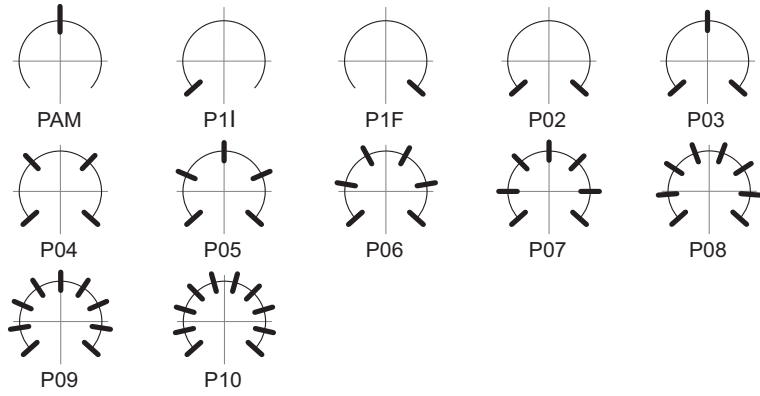

A = 26°
B = 27.5°

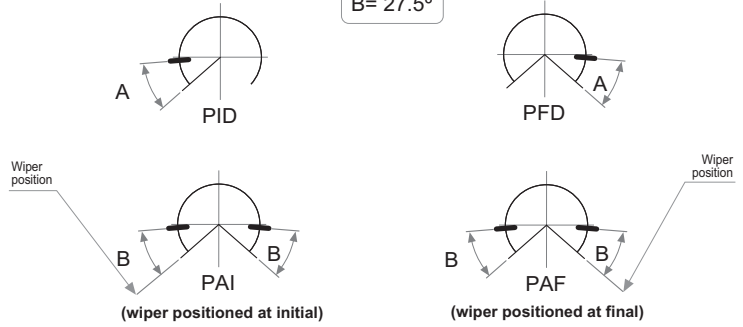

DETENT DETAILS

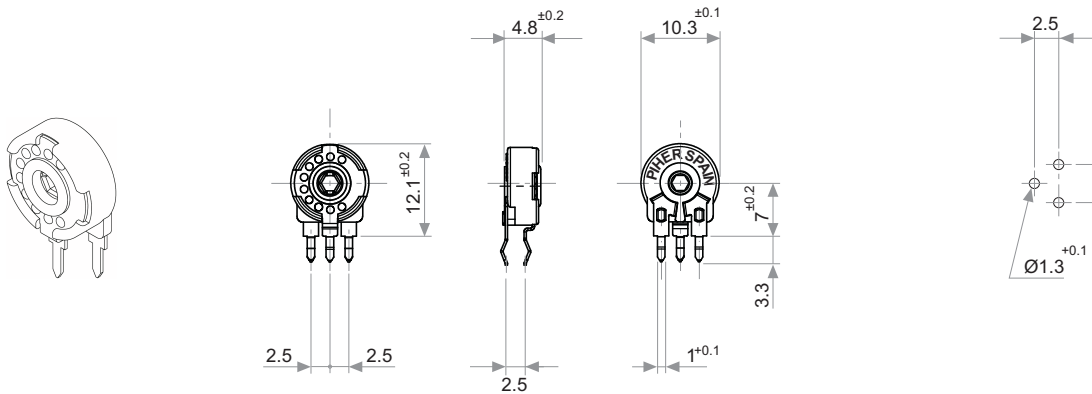

STANDARD SWITCH VERSIONS

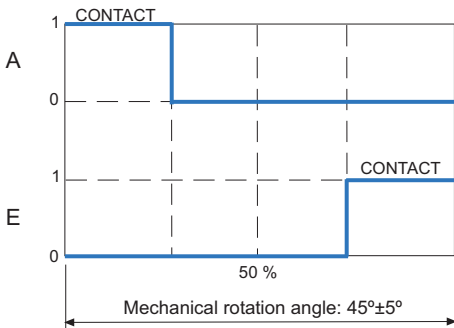

D48 Switch code (Housing colour: green)

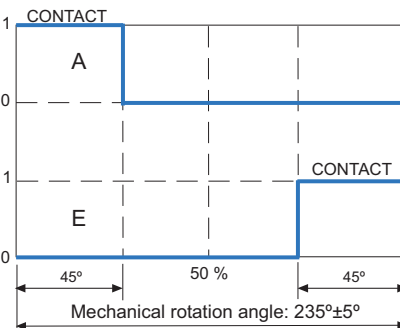

A80 Switch code

SW Standard specs.

Power Rating:
24V / 15mA

ON position resistance:
≤ 5 Ω

Insulation Resistance:
≥ 30 MΩ

Please contact Piher for ordering information.

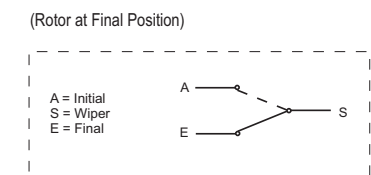

PIHER's potentiometers may feature special stepped outputs or 'constant voltage zones' for the 10mm and 15mm product families.

These constant voltage zones can be combined with PIHER's mechanical detents to provide exact alignment between the electrical output (flat areas) and the mechanical detent's positions. The result is a higher level of precision in controlling lighting, temperature, motor or other electronic control systems.

In addition to established catalogue detent configurations, we will design and manufacture any other configuration on our tried-and-tested carbon/cermet & THM/SMD potentiometer technology and processes.

With its exacting control capabilities, our 10mm and 15mm potentiometers series are well suited for many consumer applications such as ovens, ranges, dishwashers, lighting (dimmers), power hand tools, washing machines and HVAC systems.

Constant value zones can be combined with strategically located stops matching the flat areas of the output.

10 stepped outputs version example:

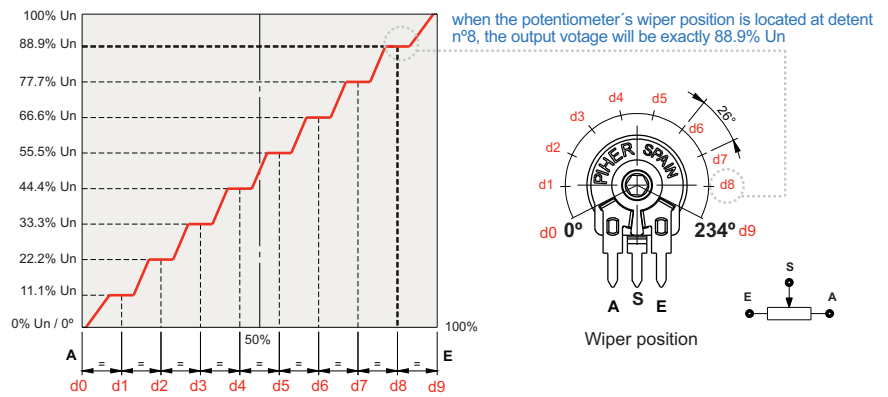

Improved repeatability

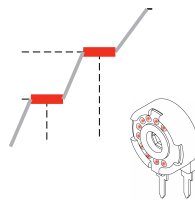

By combining the constant value zones with the detents, engineers can align the same voltage values with each of the detent stops when rotating the control both forward and backward.

This provides clear mechanical positions that are not only repeatable, but perfectly aligned electrical outputs at each of the (detent) angles.

Piher's detents also prevent output values from changing due to vibration or accidental rotor movements, furthering reliable control consistency.

Design tip. Cost-effectiveness

Absolute encoders can easily be replaced connecting the potentiometer to the microprocessor's analogue input.



Main advantages

- ✓ Unique, non-overlapping values at each stop (detent position)
- ✓ Prevents output value change due to light vibration or accidental rotor micro-movements
- ✓ Fully customisable according to customer's needs
- ✓ Cost effective replacement for absolute encoders

Disclaimer

The product information in this catalogue is for reference purposes. Please consult for the most up to date and accurate design information.

Piher Sensors & Controls S.A., its affiliates, agents, and employees, and all persons acting on its or their behalf (collectively, "Piher"), disclaim any and all liability for any errors, inaccuracies or incompleteness contained herein or in any other disclosure relating to any product described herein.

Piher disclaims any and all liability arising out of the use or application of any product described herein or of any information provided herein to the maximum extent permitted by law. The product specifications do not expand or otherwise modify Piher's terms and conditions of sale, including but not limited to the warranty expressed therein, which apply to these products.

No licence, express or implied, by estoppel or otherwise, to any intellectual property rights is granted by this document or by any conduct of Piher.

The products shown herein are not designed for use in medical, life-saving, or life-sustaining applications unless otherwise expressly indicated. Customers using or selling Piher products not expressly indicated for use in such applications do so entirely at their own risk and agree to fully indemnify Piher for any damages arising or resulting from such use or sale. Please contact authorised Piher personnel to obtain written terms and conditions regarding products designed for such applications.

Product names and markings noted herein may be trademarks of their respective owners.

Information contained in and/or attached to this catalogue may be subject to export control regulations of the European Community, USA, or other countries. Each recipient of this document is responsible to ensure that usage and/or transfer of any information contained in this document complies with all relevant export control regulations. If you are in any doubt about the export control restrictions that apply to this information, please contact the sender immediately. For any Piher International Corp. Exports, Note: All products / technologies are EAR99 Classified commodities. Exports from the United States are in accordance with the Export Administration Regulations. Diversion contrary to US law is prohibited.

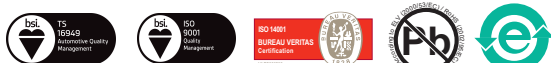

Mouser Electronics

Authorized Distributor

Click to View Pricing, Inventory, Delivery & Lifecycle Information:

Piher:

[PT10WH01-505A2020 01 CR](#) [PT10LH01-472A2020](#) [PT10LV10-502A2020](#) [PT10MH2.5-68KA](#) [PT10TH01-103A20205CM](#) [5116 \(CREAM\)](#) [PT10YV10252A2020](#) [PT10MH01-204A2020](#) [PT10LV05-103A2020E](#)
[PT10YV10502A2020](#) [PT10MV10-503A2020](#) [PT10MH01254A2020](#) [PT10LH01-00039](#) [PT10YV10-473A2020](#)
[PT10LH01-205A3030](#) [PT10MH01-253A2020](#) [PT10MH01-101A2020](#) [PT10LH01-201A2020](#) [PT10MV10-255A3030](#)
[PT10MV10-252A2020](#) [PT10MH01-202A2020](#) [PT10MH01-205A3030](#) [PT10LH01-474A2020](#) [PT10LH01-255A3030](#)
[PT10LH01-252A2020](#) [PT10MH01-102A2020](#) [PT10MH01-505A3030](#) [PT10MH01-105A2020](#) [PT10MV10-204A2020](#)
[PT10LV20KC](#) [PT10MV10-104A2020](#) [PT10LH01-204A2020](#) [PT10MV10-251A2020](#) [PT10MV10-201A2020](#)
[PT10XH01505A303001NE](#) [PT10LV 220A](#) [PT10LV10-251A2020](#) [PT10LV10-201A2020](#) [5116NEI \(BLACK\)](#)
[PT10XV103A2020-9NE](#) [PT10MV10-501A2020](#) [PT10YV11 254A2020](#) [PT10LH01-223A2020](#) [PT10LH01-254A2020](#)
[PT10WH01-253A2020-1CRPM](#) [PT10MH01-504A2020](#) [PT10MH01-505A3050](#) [JPEPL5012NE](#) [PT10MH01-223A2020](#)
[PT10MH01-203A2020](#) [PT10MV10-101A2020](#) [PT10MH01-501A2020](#) [PT10LV10-00258-PT10LV10-502A2020](#)
[PT10LV10-473A2020](#) [PT10MV10-103A2020](#) [PT10YV11 253A2020](#) [PT10LH01-00037-PT10LH01-503A2020](#)
[PT10MH01-201A2020](#) [5115CR](#) [PT10MH01-251A2020](#) [PT10WH01505A303001NE](#) [PT10WH01-504A2020-1CRPM](#)
[PT10MH01205A3030](#) [PT10WH01-505A3050 01 CR](#) [PT10LV10K](#) [PT10MV10-203A2020](#) [PT10MV10-223A2020](#)
[PT10MV10-202A2020](#) [PT10MV10-505A3030](#) [PT10MV10-502A2020](#) [PT10MV10-205A3030](#) [PT10MH01-252A2020](#)
[PT10MH01-255A3030](#) [PT10WH01-505A3030 01 CR](#) [PT10YV11 502A2020](#) [PT10MH01-503A2020](#) [PT10LH01-503A2020](#)
[PT10MV10-253A2020](#) [PT10MV10-102A2020](#) [PT10MV10-105A2020](#) [PT10MH01-103A2020](#) [5034CR](#)
[PT10MV10-151A2020](#) [PT10YV10-105A2020-5NE](#) [PT10YV10-105A2020-5CR](#) [PT10MV10-504A2020](#) [PT10MV10-224A2020](#)
[PT10MV10-254A2020](#) [PT10YV10103A2020](#) [PT10LV05-202A2020E](#) [PT10MH01-151A2020](#) [PT10LH01-251A2020](#)
[PT10YV10203A2020](#) [PT10WH2.5-5KA-1](#) [PT10MH01-224A2020](#) [PT10LH01-103B2020](#) [PT10LV10-225A3030](#)
[PT10V10-223A2020](#) [PT10YV11 101A2020](#) [PT10MH01-505A2020](#)