

ADXL210E

FEATURES

2-Axis Acceleration Sensor on a Single IC Chip
5 mm × 5 mm × 2 mm Ultrasmall Chip Scale Package
2 mg Resolution at 60 Hz
Low Power < 0.6 mA
Direct Interface to Low-Cost Microcontrollers via
Duty Cycle Output
BW Adjustment with a Single Capacitor
3 V to 5.25 V Single-Supply Operation
1000 g Shock Survival

APPLICATIONS

2-Axis Tilt Sensing with Faster Response than
Electrolytic, Mercury, or Thermal Sensors
Computer Peripherals
Information Appliances
Alarms and Motion Detectors
Disk Drives
Vehicle Security

GENERAL DESCRIPTION

The ADXL210E is a low-cost, low-power, complete 2-axis accelerometer with a digital output, all on a single monolithic IC. It is an improved version of the ADXL210AQC/JQC. The ADXL210E will measure accelerations with a full-scale range of $\pm 10 g$. The ADXL210E can measure both dynamic acceleration (e.g., vibration) and static acceleration (e.g., gravity).

The outputs are analog voltage or digital signals whose duty cycles (ratio of pulsewidth to period) are proportional to acceleration. The duty cycle outputs can be directly measured by a microprocessor counter without an A/D converter or glue logic. The duty cycle period is adjustable from 0.5 ms to 10 ms via a single resistor (R_{SET}).

FUNCTIONAL BLOCK DIAGRAM

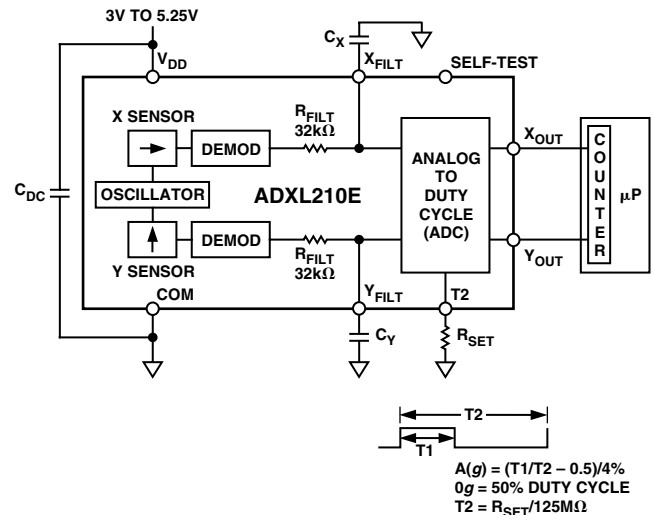

The typical noise floor is $200 \mu g \sqrt{Hz}$, allowing signals below 2 mg (at 60 Hz bandwidth) to be resolved.

The bandwidth of the accelerometer is set with capacitors C_X and C_Y at the X_{FILT} and Y_{FILT} pins. An analog output can be reconstructed by filtering the duty cycle output.

The ADXL210E is available in a 5 mm × 5 mm × 2 mm 8-lead hermetic LCC package.

REV. 0

Information furnished by Analog Devices is believed to be accurate and reliable. However, no responsibility is assumed by Analog Devices for its use, nor for any infringements of patents or other rights of third parties that may result from its use. No license is granted by implication or otherwise under any patent or patent rights of Analog Devices.

ADXL210E—SPECIFICATIONS ($T_A = T_{MIN}$ to T_{MAX} , $T_A = 25^\circ\text{C}$ for J Grade only, $V_{DD} = 5\text{ V}$, $R_{SET} = 125\text{ k}\Omega$, Acceleration = 0 g , unless otherwise noted.)

Parameter	Conditions	ADXL210JE			ADXL210AE			Unit
		Min	Typ	Max	Min	Typ	Max	
SENSOR INPUT								
Measurement Range ¹	Each Axis	± 8	± 10		± 8	± 10		g
Nonlinearity	Best Fit Straight Line		0.2			0.2		% of FS
Alignment Error ^{2, 3}			± 1			± 1		Degrees
Alignment Error	X Sensor to Y Sensor		0.01			0.01		Degrees
Cross-Axis Sensitivity ^{2, 4}			± 2			± 2		%
SENSITIVITY								
Duty Cycle per g^2	Each Axis T1/T2, $V_{DD} = 5\text{ V}$	3.3	4.0	4.9	3.2	4.0	5	%/g
Duty Cycle per g^2	T1/T2, $V_{DD} = 3\text{ V}$	3.2	3.8	4.4	3.0	3.8	4.6	%/g
Sensitivity X_{FILT} , Y_{FILT} ²	$V_{DD} = 5\text{ V}$	85	100	125	80	100	130	mV/g
Sensitivity X_{FILT} , Y_{FILT} ²	$V_{DD} = 3\text{ V}$	45	55	65	40	55	70	mV/g
Temperature Drift ^{2, 5}	Delta from 25°C		± 0.5			± 0.5		%
ZERO g BIAS LEVEL								
0 g Duty Cycle ²	Each Axis T1/T2, $V_{DD} = 5\text{ V}$	44	50	56	42	50	58	%
0 g Duty Cycle ²	T1/T2, $V_{DD} = 3\text{ V}$	40	50	60	38	50	62	%
0 g Voltage X_{FILT} , Y_{FILT} ²	$V_{DD} = 5\text{ V}$	2.3	2.5	2.7	2.3	2.5	2.7	V
0 g Voltage X_{FILT} , Y_{FILT} ²	$V_{DD} = 3\text{ V}$	1.35	1.5	1.65	1.3	1.5	1.7	V
0 g Duty Cycle vs. Supply ²			1.0	4.0		1.0	4.0	%/V
0 g Offset vs. Temperature ^{2, 5}	Delta from 25°C		2.0			2.0		mg/ $^\circ\text{C}$
NOISE PERFORMANCE								
Noise Density ²	@ 25°C		200			200	1000	$\mu\text{g}\sqrt{\text{Hz}}$ rms
FREQUENCY RESPONSE								
3 dB Bandwidth	At Pins X_{FILT} , Y_{FILT}		6			6		kHz
Sensor Resonant Frequency			10			10		kHz
FILTER								
R_{FILT} Tolerance	32 k Ω Nominal		± 15			± 15		%
Minimum Capacitance	At Pins X_{FILT} , Y_{FILT}	1000			1000			pF
SELF-TEST								
Duty Cycle Change	Self-Test "0" to "1"		3			3		%
DUTY CYCLE OUTPUT STAGE								
F_{SET}	$R_{SET} = 125\text{ k}\Omega$	0.7		1.3	0.7		1.3	kHz
Output High Voltage	$I = 25\text{ }\mu\text{A}$	$V_S - 200\text{ mV}$			$V_S - 200\text{ mV}$			V
Output Low Voltage	$I = 25\text{ }\mu\text{A}$			200			200	mV
T2 Drift vs. Temperature			50			50		ppm/ $^\circ\text{C}$
Rise/Fall Time			200			200		ns
POWER SUPPLY								
Operating Voltage Range		3		5.25	3.0		5.25	V
Quiescent Supply Current			0.6	1.0		0.6	1.0	mA
Turn-On Time	C_{FILT} in μF	$160 \times C_{FILT} + 0.3$			$160 \times C_{FILT} + 0.3$			ms
TEMPERATURE RANGE								
Specified Performance AE					-40		+85	$^\circ\text{C}$
Operating Range		0		70	-40		+85	$^\circ\text{C}$

NOTES

¹Guaranteed by measurement of initial offset and sensitivity.

²See Typical Performance Characteristics.

³Alignment error is specified as the angle between the true and indicated axis of sensitivity (see TPC 15).

⁴Cross-axis sensitivity is the algebraic sum of the alignment and the inherent sensitivity errors.

⁵Defined as the output change from ambient to maximum temperature or ambient to minimum temperature.

Specifications subject to change without notice.

ABSOLUTE MAXIMUM RATINGS*

Acceleration (Any Axis, Unpowered for 0.5 ms) 1000 *g*
 Acceleration (Any Axis, Powered for 0.5 ms) 500 *g*
 +V_S -0.3 V to +6.0 V
 Output Short Circuit Duration, (Any Pin to Common)
 Indefinite
 Operating Temperature -55°C to +125°C
 Storage Temperature -65°C to +150°C

*Stresses above those listed under Absolute Maximum Ratings may cause permanent damage to the device. This is a stress rating only; functional operation of the device at these or any other conditions above those indicated in the operational sections of this specification is not implied. Exposure to absolute maximum rating conditions for extended periods may affect device reliability.

Drops onto hard surfaces can cause shocks of greater than 1000 *g* and exceed the absolute maximum rating of the device. Care should be exercised in handling to avoid damage.

PACKAGE CHARACTERISTICS

Package Weight	θ_{JA}	θ_{JC}	Device
8-Lead LCC	120°C/W	TBD°C/W	<1.0 grams

PIN CONFIGURATION

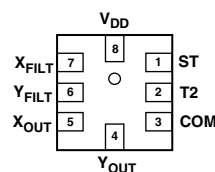

BOTTOM VIEW

PIN FUNCTION DESCRIPTIONS

Pin No.	Mnemonic	Description
1	ST	Self-Test
2	T2	Connect R _{SET} to Set T2 Period
3	COM	Common
4	Y _{OUT}	Y-Channel Duty Cycle Output
5	X _{OUT}	X-Channel Duty Cycle Output
6	Y _{FILT}	Y-Channel Filter Pin
7	X _{FILT}	X-Channel Filter Pin
8	V _{DD}	3 V to 5.25 V

ORDERING GUIDE

Model	No. of Axes	Specified Voltage	Temperature Range	Package Description	Package Option
ADXL210JE	2	3 V to 5 V	0 to 70°C	8-Lead LCC	E-8
ADXL210AE*	2	3 V to 5 V	-40°C to +85°C	8-Lead LCC	E-8

*Available Soon

CAUTION

ESD (electrostatic discharge) sensitive device. Electrostatic charges as high as 4000 V readily accumulate on the human body and test equipment and can discharge without detection. Although the ADXL210E features proprietary ESD protection circuitry, permanent damage may occur on devices subjected to high-energy electrostatic discharges. Therefore, proper ESD precautions are recommended to avoid performance degradation or loss of functionality.



ADXL210E—Typical Performance Characteristics*

$V_{DD} = 3\text{ V}$

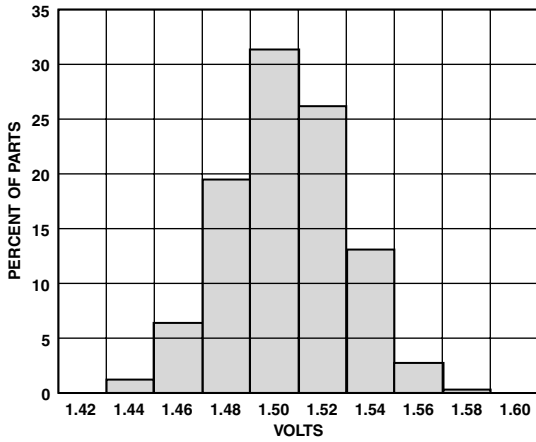

TPC 1. X-Axis Zero g Bias Distribution at X_{FILTER} , $V_{DD} = 3\text{ V}$

$V_{DD} = 5\text{ V}$

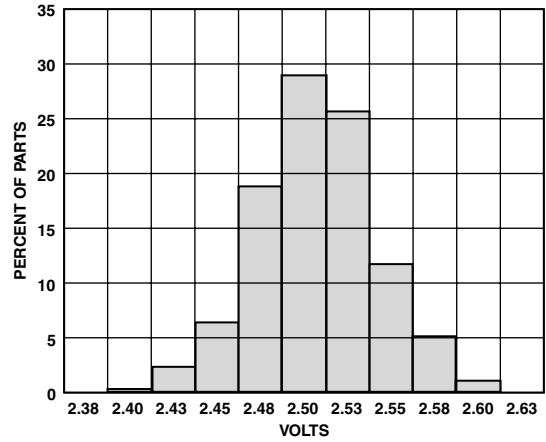

TPC 4. X-Axis Zero g Bias Distribution at X_{FILTER} , $V_{DD} = 5\text{ V}$

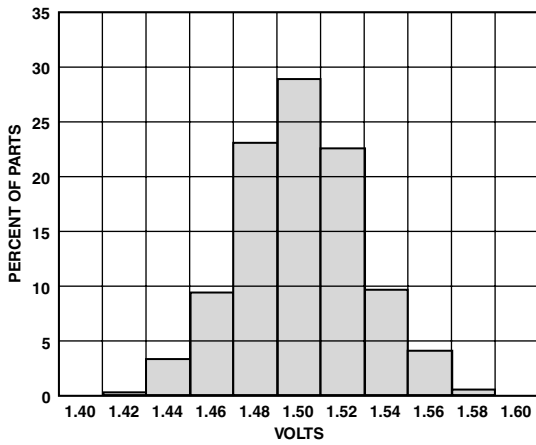

TPC 2. Y-Axis Zero g Bias Distribution at Y_{FILTER} , $V_{DD} = 3\text{ V}$

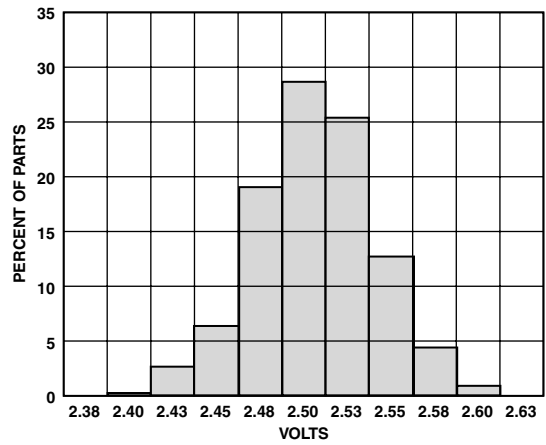

TPC 5. Y-Axis Zero g Bias Distribution at Y_{FILTER} , $V_{DD} = 5\text{ V}$

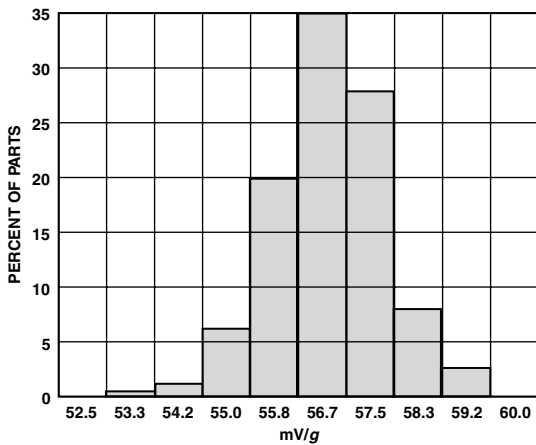

TPC 3. X-Axis Sensitivity Distribution at X_{FILTER} , $V_{DD} = 3\text{ V}$

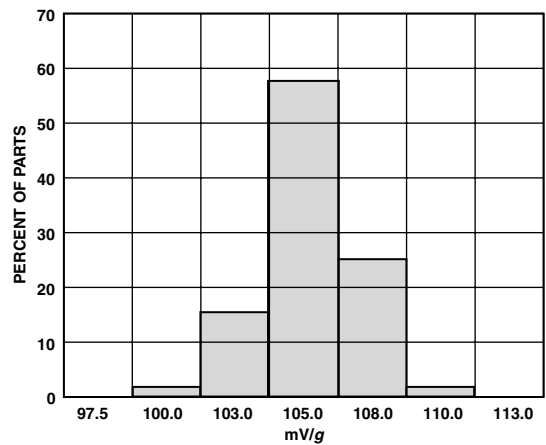

TPC 6. X-Axis Sensitivity Distribution at X_{FILTER} , $V_{DD} = 5\text{ V}$

*Data taken from 14,500 parts over 3 lots minimum.

$V_{DD} = 3\text{ V}$

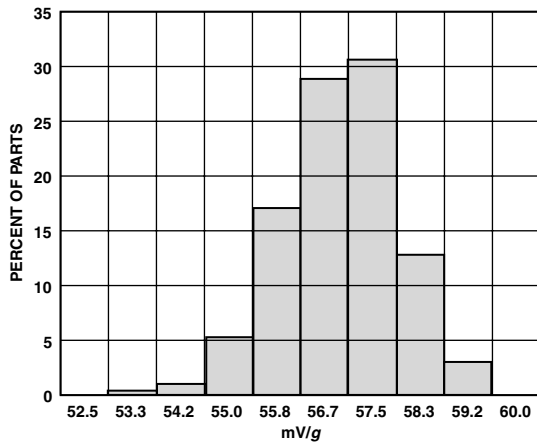

TPC 7. Y-Axis Sensitivity Distribution at Y_{FILT} , $V_{DD} = 3\text{ V}$

$V_{DD} = 3\text{ V}$

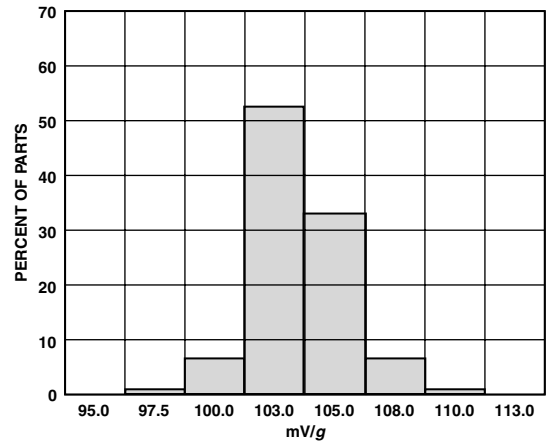

TPC 10. Y-Axis Sensitivity Distribution at Y_{FILT} , $V_{DD} = 5\text{ V}$

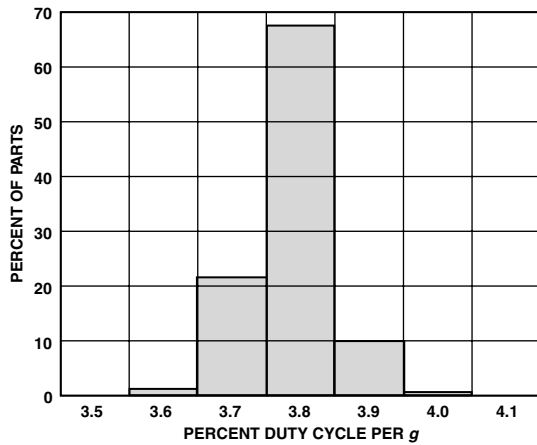

TPC 8. X-Axis Sensitivity Distribution at X_{OUT} , $V_{DD} = 3\text{ V}$

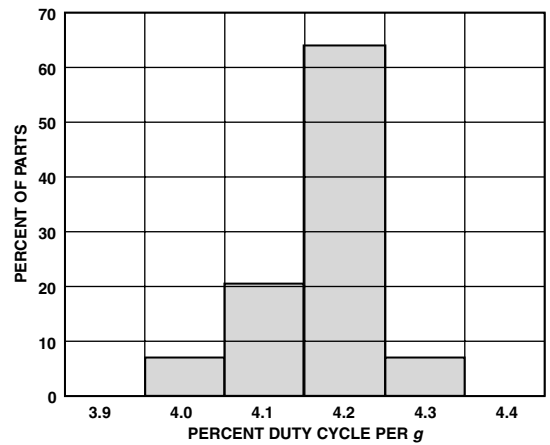

TPC 11. X-Axis Sensitivity Distribution at X_{OUT} , $V_{DD} = 5\text{ V}$

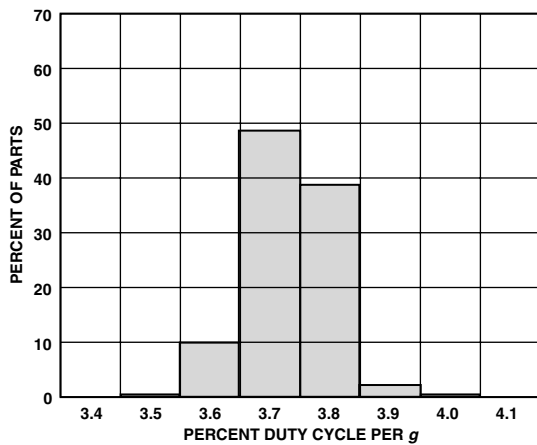

TPC 9. Y-Axis Sensitivity Distribution at Y_{OUT} , $V_{DD} = 3\text{ V}$

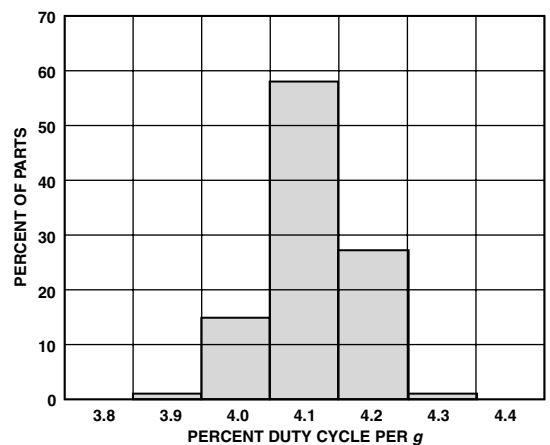

TPC 12. Y-Axis Sensitivity Distribution at Y_{OUT} , $V_{DD} = 5\text{ V}$

ADXL210E

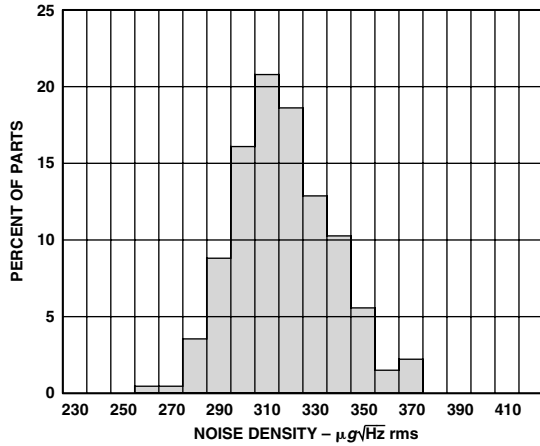

TPC 13. Noise Density Distribution, $V_{DD} = 3\text{ V}$

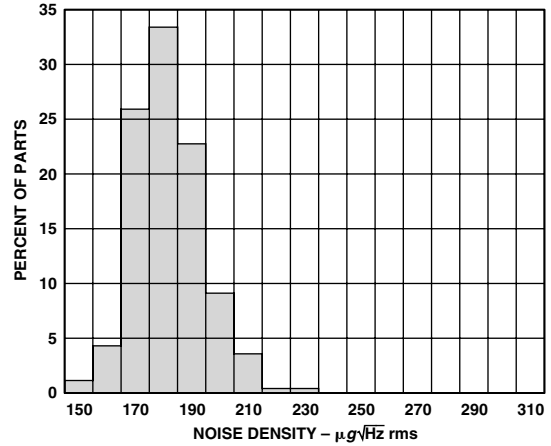

TPC 16. Noise Density Distribution, $V_{DD} = 5\text{ V}$

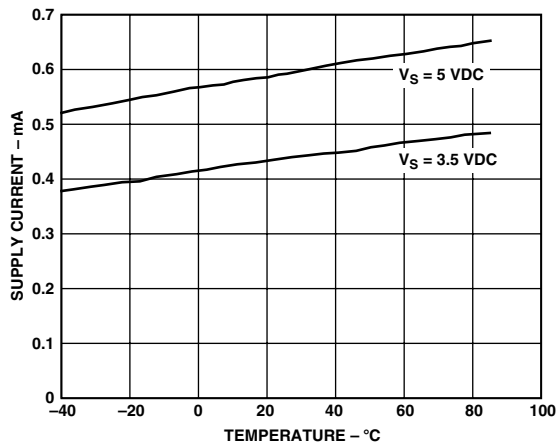

TPC 14. Typical Supply Current vs. Temperature

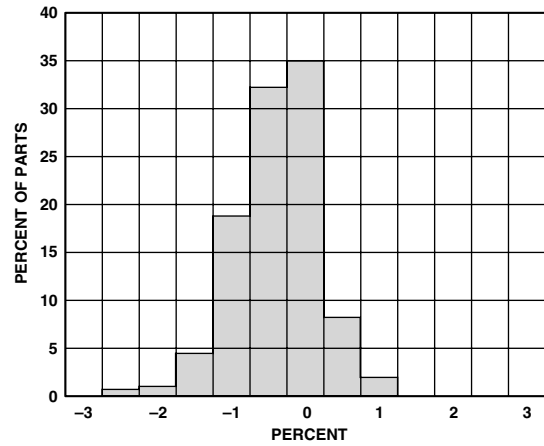

TPC 17. Cross-Axis Sensitivity Distribution

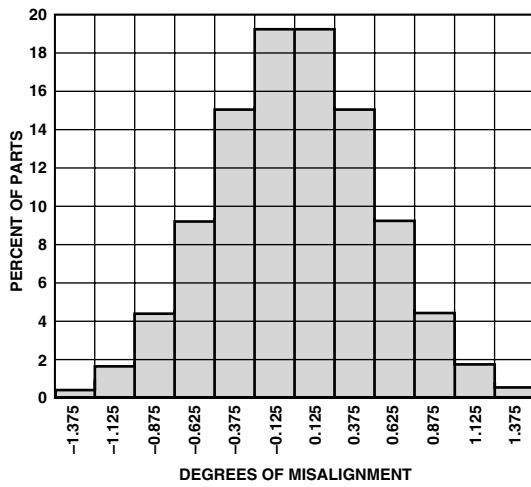

TPC 15. Rotational Die Alignment

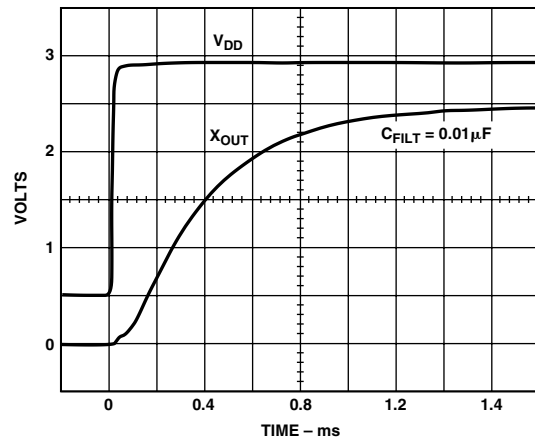

TPC 18. Typical Turn-On Time

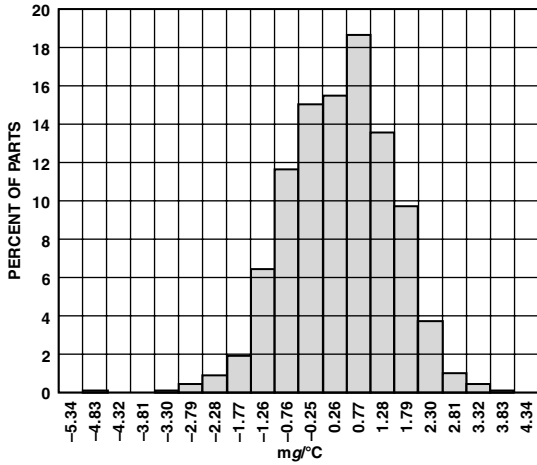

TPC 19. X-Axis Zero g Drift Due to Temperature Distribution, -40°C to +85°C

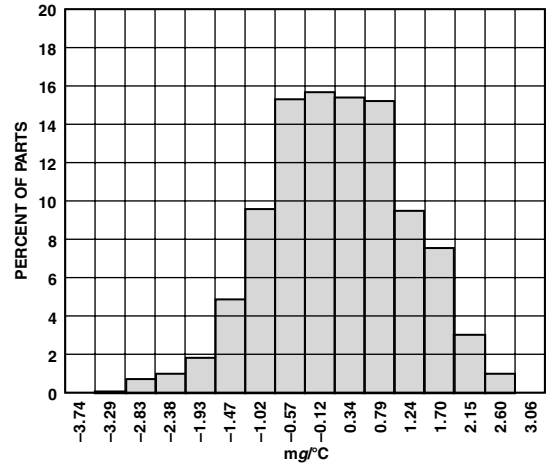

TPC 22. Y-Axis Zero g Drift Due to Temperature Distribution, -40°C to +85°C

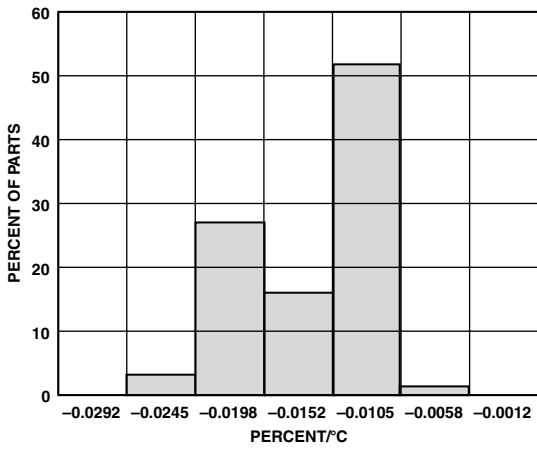

TPC 20. X-Axis Sensitivity Drift at X_{FILTER} Due to Temperature Distribution, -40°C to +85°C

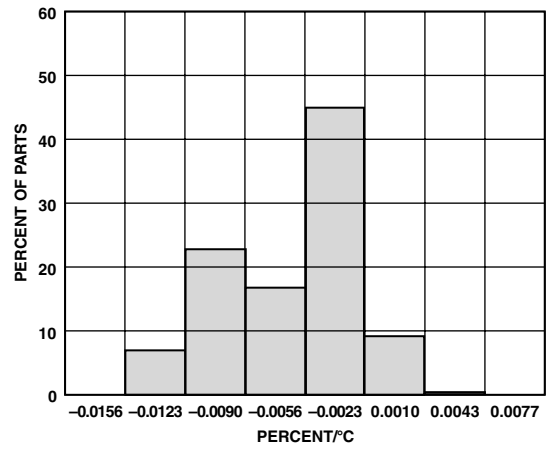

TPC 23. Y-Axis Sensitivity Drift at X_{FILTER} Due to Temperature Distribution, -40°C to +85°C

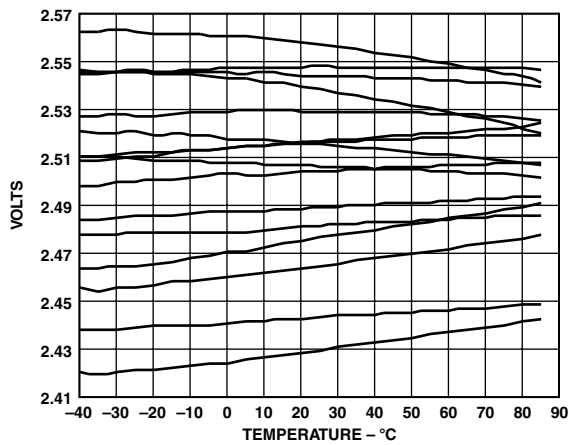

TPC 21. Typical X-Axis Zero g Output vs. Temperature for 16 Parts

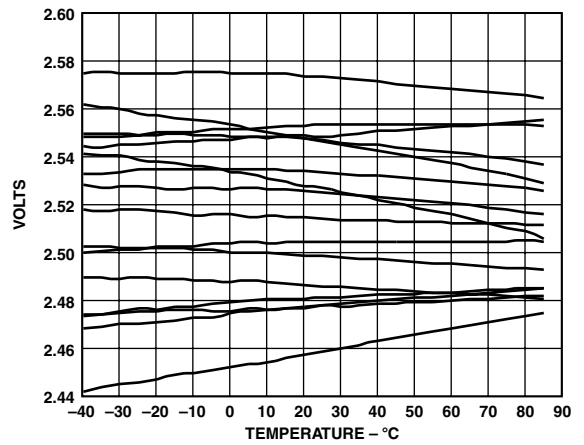

TPC 24. Typical Y-Axis Zero g Output vs. Temperature for 16 Parts

ADXL210E

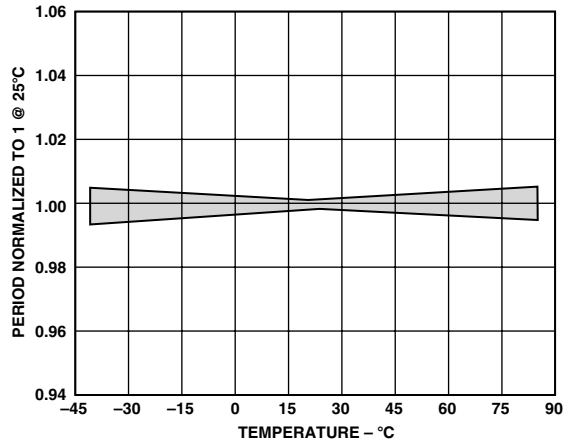

TPC 25. Normalized DCM Period (T2) vs. Temperature

DEFINITIONS

- T1 Length of the “on” portion of the cycle.
- T2 Length of the total cycle.
- Duty Cycle Ratio of the “on” time (T1) of the cycle to the total cycle (T2). Defined as T1/T2 for the ADXL210E/ADXL210.
- Pulsewidth Time period of the “on” pulse. Defined as T1 for the ADXL210E/ADXL210.

THEORY OF OPERATION

The ADXL210E is a complete, dual-axis acceleration measurement system on a single monolithic IC. It contains a polysilicon surface-micromachined sensor and signal conditioning circuitry to implement an open loop acceleration measurement architecture. For each axis, an output circuit converts the analog signal to a duty cycle modulated (DCM) digital signal that can be decoded with a counter/timer port on a microprocessor. The ADXL210E is capable of measuring both positive and negative accelerations to $\pm 10 g$. The accelerometer can measure static acceleration forces such as gravity, allowing it to be used as a tilt sensor.

The sensor is a surface micromachined polysilicon structure built on top of the silicon wafer. Polysilicon springs suspend the structure over the surface of the wafer and provide a resistance against acceleration forces. Deflection of the structure is measured using a differential capacitor that consists of independent fixed plates and central plates attached to the moving mass. The fixed plates are driven by 180° out of phase square waves. An acceleration will deflect the beam and unbalance the differential capacitor, resulting in an output square wave whose amplitude is proportional to acceleration. Phase sensitive demodulation techniques are then used to rectify the signal and determine the direction of the acceleration.

The output of the demodulator drives a duty cycle modulator (DCM) stage through a $32 k\Omega$ resistor. At this point a pin is available on each channel to allow the user to set the signal bandwidth of the device by adding a capacitor. This filtering improves measurement resolution and helps prevent aliasing.

After being low-pass filtered, the analog signal is converted to a duty cycle modulated signal by the DCM stage. A single resistor sets the period for a complete cycle (T2), which can be set between 0.5 ms and 10 ms (see TPC 12). A 0 g acceleration produces a

nominally 50% duty cycle. The acceleration signal can be determined by measuring the length of the T1 and T2 pulses with a counter/timer or with a polling loop using a low cost microcontroller.

An analog output voltage can be obtained either by buffering the signal from the X_{FILT} and Y_{FILT} pin, or by passing the duty cycle signal through an RC filter to reconstruct the dc value.

The ADXL210E will operate with supply voltages as low as 3.0 V or as high as 5.25 V.

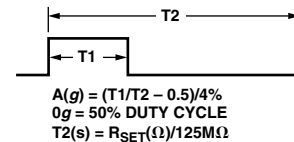

Figure 1. Typical Output Duty Cycle

APPLICATIONS

POWER SUPPLY DECOUPLING

For most applications a single $0.1 \mu F$ capacitor, C_{DC}, will adequately decouple the accelerometer from signal and noise on the power supply. However, in some cases, especially where digital devices such as microcontrollers share the same power supply, digital noise on the supply may cause interference on the ADXL210E output. This may be observed as a slowly undulating fluctuation of voltage at X_{FILT} and Y_{FILT}. If additional decoupling is needed, a 100Ω (or smaller) resistor or ferrite beads, may be inserted in the supply line of the ADXL210E.

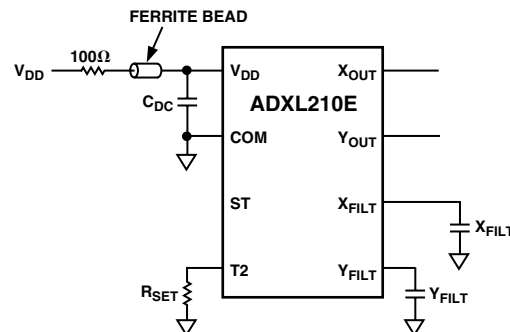

Figure 2.

DESIGN PROCEDURE FOR THE ADXL210E

The design procedure for using the ADXL210E with a duty cycle output involves selecting a duty cycle period and a filter capacitor. A proper design will take into account the application requirements for bandwidth, signal resolution and acquisition time, as discussed in the following sections.

Decoupling Capacitor C_{DC}

A 0.1 μF capacitor is recommended from V_{DD} to COM for power supply decoupling.

ST

The ST pin controls the self-test feature. When this pin is set to V_{DD} , an electrostatic force is exerted on the beam of the accelerometer. The resulting movement of the beam allows the user to test if the accelerometer is functional. The typical change in output will be 3% at the duty cycle outputs (corresponding to 800 mg). This pin may be left open circuit or connected to common in normal use.

Duty Cycle Decoding

The ADXL210E's digital output is a duty cycle modulator. Acceleration is proportional to the ratio $T1/T2$. The nominal output of the ADXL210E is:

$$0\text{ g} = 50\% \text{ Duty Cycle}$$

Scale factor is 4% Duty Cycle Change per g

These nominal values are affected by the initial tolerance of the device including zero g offset error and sensitivity error.

$T2$ does not have to be measured for every measurement cycle. It need only be updated to account for changes due to temperature (a relatively slow process). Since the $T2$ time period is shared by both X and Y channels, it is necessary only to measure it on one channel of the ADXL210E. Decoding algorithms for various microcontrollers have been developed. Consult the appropriate Application Note.

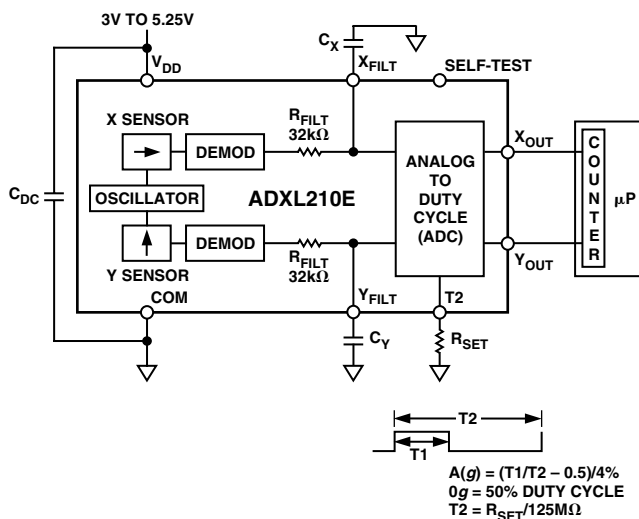

Figure 3. Block Diagram

Setting the Bandwidth Using C_X and C_Y

The ADXL210E has provisions for bandlimiting the X_{FILT} and Y_{FILT} pins. Capacitors must be added at these pins to implement low-pass filtering for antialiasing and noise reduction. The equation for the 3 dB bandwidth is:

$$F_{-3\text{ dB}} = \frac{1}{(2\pi(32\text{ k}\Omega) \times C_{(x,y)})}$$

or, more simply,

$$F_{-3\text{ dB}} = \frac{5\mu\text{F}}{C_{(x,y)}}$$

The tolerance of the internal resistor (R_{FILT}), can vary typically as much as $\pm 15\%$ of its nominal value of 32 k Ω ; so the bandwidth will vary accordingly. A minimum capacitance of 1000 pF for $C_{(X, Y)}$ is required in all cases.

Table I. Filter Capacitor Selection, C_X and C_Y

Bandwidth	Capacitor Value
10 Hz	0.47 μF
50 Hz	0.10 μF
100 Hz	0.05 μF
200 Hz	0.027 μF
500 Hz	0.01 μF
5 kHz	0.001 μF

Setting the DCM Period with R_{SET}

The period of the DCM output is set for both channels by a single resistor from R_{SET} to ground. The equation for the period is:

$$T2 = \frac{R_{SET}(\Omega)}{125\text{ M}\Omega}$$

A 125 k Ω resistor will set the duty cycle repetition rate to approximately 1 kHz, or 1 ms. The device is designed to operate at duty cycle periods between 0.5 ms and 10 ms.

Table II. Resistor Values to Set $T2$

$T2$	R_{SET}
1 ms	125 k Ω
2 ms	250 k Ω
5 ms	625 k Ω
10 ms	1.25 M Ω

Note that the R_{SET} should always be included, even if only an analog output is desired. Use an R_{SET} value between 500 k Ω and 2 M Ω when taking the output from X_{FILT} or Y_{FILT} . The R_{SET} resistor should be placed close to the $T2$ Pin to minimize parasitic capacitance at this node.

Selecting the Right Accelerometer

For most tilt sensing applications the ADXL202E is the most appropriate accelerometer. Its higher sensitivity (12.5%/g) allows the user to use a lower speed counter for PWM decoding while maintaining high resolution. The ADXL210E should be used in applications where accelerations of greater than $\pm 2\text{ g}$ are expected.

ADXL210E

MICROCOMPUTER INTERFACES

The ADXL210E is specifically designed to work with low-cost microcontrollers. Specific code sets, reference designs, and application notes are available from the factory. This section will outline a general design procedure and discuss the various trade-offs that need to be considered.

The designer should have some idea of the required performance of the system in terms of:

Resolution: the smallest signal change that needs to be detected.

Bandwidth: the highest frequency that needs to be detected.

Acquisition Time: the time that will be available to acquire the signal on each axis.

These requirements will help to determine the accelerometer bandwidth, the speed of the microcontroller clock and the length of the T2 period.

When selecting a microcontroller it is helpful to have a counter timer port available. The microcontroller should have provisions for software calibration. While the ADXL210E is a highly accurate accelerometer, it has a wide tolerance for initial offset. The easiest way to null this offset is with a calibration factor saved on the microcontroller or by a user calibration for zero *g*. In the case where the offset is calibrated during manufacture, there are several options, including external EEPROM and microcontrollers with “one-time programmable” features.

DESIGN TRADE-OFFS FOR SELECTING FILTER CHARACTERISTICS: THE NOISE/BW TRADE-OFF

The accelerometer bandwidth selected will determine the measurement resolution (smallest detectable acceleration). Filtering can be used to lower the noise floor and improve the resolution of the accelerometer. Resolution is dependent on both the analog filter bandwidth at X_{FILT} and Y_{FILT} and on the speed of the microcontroller counter.

The analog output of the ADXL210E has a typical bandwidth of 5 kHz, while the duty cycle modulators’ bandwidth is 500 Hz. The user must filter the signal at this point to limit aliasing errors. To minimize DCM errors the analog bandwidth should be less than one-tenth the DCM frequency. Analog bandwidth may be increased to up to half the DCM frequency in many applications. This will result in greater dynamic error generated at the DCM.

The analog bandwidth may be further decreased to reduce noise and improve resolution. The ADXL210E noise has the characteristics of white Gaussian noise that contributes equally at all frequencies and is described in terms of μg per root Hz; i.e., the noise is proportional to the square root of the bandwidth of the accelerometer. It is recommended that the user limit bandwidth to the lowest frequency needed by the application to maximize the resolution and dynamic range of the accelerometer.

With the single pole roll-off characteristic, the typical noise of the ADXL210E is determined by the following equation:

$$\text{Noise (rms)} = \left(200 \mu\text{g} / \sqrt{\text{Hz}}\right) \times \left(\sqrt{\text{BW} \times 1.6}\right)$$

At 100 Hz the noise will be:

$$\text{Noise (rms)} = \left(200 \mu\text{g} / \sqrt{\text{Hz}}\right) \times \left(\sqrt{100 \times (1.6)}\right) = 2.53 \text{ mg}$$

Often the peak value of the noise is desired. Peak-to-peak noise can only be estimated by statistical methods. Table III is useful for estimating the probabilities of exceeding various peak values, given the rms value.

Table III. Estimation of Peak-to-Peak Noise

Nominal Peak-to-Peak Value	% of Time that Noise Will Exceed Nominal Peak-to-Peak Value
2.0 × rms	32%
4.0 × rms	4.6%
6.0 × rms	0.27%
8.0 × rms	0.006%

The peak-to-peak noise value will give the best estimate of the uncertainty in a single measurement.

Table IV gives typical noise output of the ADXL210E for various C_X and C_Y values.

Table IV. Filter Capacitor Selection, C_X and C_Y

Bandwidth	C _X , C _Y	rms Noise	Peak-to-Peak Noise Estimate 95% Probability (rms × 4)
10 Hz	0.47 μF	0.8 mg	3.2 mg
50 Hz	0.10 μF	1.8 mg	7.2 mg
100 Hz	0.05 μF	2.5 mg	10.1 mg
200 Hz	0.027 μF	3.6 mg	14.3 mg
500 Hz	0.01 μF	5.7 mg	22.6 mg

CHOOSING T2 AND COUNTER FREQUENCY: DESIGN TRADE-OFFS

The noise level is one determinant of accelerometer resolution. The second relates to the measurement resolution of the counter when decoding the duty cycle output.

The ADXL210E’s duty cycle converter has a resolution of approximately 14 bits; better resolution than the accelerometer itself. The actual resolution of the acceleration signal is, however, limited by the time resolution of the counting devices used to decode the duty cycle. The faster the counter clock, the higher the resolution of the duty cycle and the shorter the T2 period can be for a given resolution. The following table shows some of the trade-offs. It is important to note that this is the resolution due to the microprocessors’ counter. It is probable that the accelerometer’s noise floor may set the lower limit on the resolution, as discussed in the previous section.

Table V. Trade-Offs Between Microcontroller Counter Rate, T2 Period, and Resolution of Duty Cycle Modulator

T2 (ms)	R _{SET} (kΩ)	ADXL210E Sample Rate	Counter-Clock Rate (MHz)	Counts per T2 Cycle	Counts per g	Resolution (mg)
1.0	124	1000	2.0	2000	80	12.50
1.0	124	1000	1.0	1000	40	25.00
1.0	124	1000	0.5	500	20	50.00
5.0	625	200	2.0	10000	400	2.50
5.0	625	200	1.0	5000	200	5.00
5.0	625	200	0.5	2500	100	10.00
10.0	1250	100	2.0	20000	800	1.25
10.0	1250	100	1.0	10000	400	2.50
10.0	1250	100	0.5	5000	200	5.00

USING THE ANALOG OUTPUT

The ADXL210E was specifically designed for use with its digital outputs, but has provisions to provide analog outputs as well.

Duty Cycle Filtering

An analog output can be reconstructed by filtering the duty cycle output. This technique requires only passive components. The duty cycle period (T2) should be set to <1 ms. An RC filter with a 3 dB point at least a factor of >10 less than the duty cycle frequency is connected to the duty cycle output. The filter resistor should be no less than 100 kΩ to prevent loading of the output stage. The analog output signal will be ratiometric to the supply voltage. The advantage of this method is an output scale factor of approximately double the analog output. Its disadvantage is that the frequency response will be lower than when using the X_{FILT}, Y_{FILT} output.

X_{FILT}, Y_{FILT} Output

The second method is to use the analog output present at the X_{FILT} and Y_{FILT} pin. Unfortunately, these pins have a 32 kΩ output impedance and are not designed to drive a load directly. An op amp follower may be required to buffer this pin. The advantage of this method is that the full 5 kHz bandwidth of the accelerometer is available to the user. A capacitor still must be added at this point for filtering. The duty cycle converter should be kept running by using R_{SET} <10 MΩ. Note that the accelerometer offset and sensitivity are ratiometric to the supply voltage. The offset and sensitivity are nominally:

$$0\text{ g Offset} = V_{DD}/2$$

$$ADXL210E\text{ Sensitivity} = (20\text{ mV} \times V_S)/g$$

USING THE ADXL210E IN VERY LOW POWER APPLICATIONS

An application note outlining low power strategies for the ADXL210E is available. Some key points are presented here. It is possible to reduce the ADXL210E's average current from 0.6 mA to less than 20 μA by using the following techniques:

1. Power cycle the accelerometer.
2. Run the accelerometer at a lower voltage (down to 3 V).

Power Cycling with an External A/D

Depending on the value of the X_{FILT} capacitor, the ADXL210E is capable of turning on and giving a good reading in 1.6 ms. Most microcontroller-based A/Ds can acquire a reading in another 25 μs. Thus it is possible to turn on the ADXL210E and take a reading in <2 ms. If we assume that a 20 Hz sample rate is sufficient, the total current required to take 20 samples is:

$$2\text{ ms} \times 20\text{ Samples/s} \times 0.6\text{ mA} = 24\text{ }\mu\text{A}$$

Running the part at 3 V will reduce the supply current from 0.6 mA to 0.4 mA, bringing the average current down to 16 μA.

The A/D should read the analog output of the ADXL210E at the X_{FILT} and Y_{FILT} pins. A buffer amplifier is recommended, and may be required in any case to amplify the analog output to give enough resolution with an 8-bit to 10-bit converter.

Power Cycling When Using the Digital Output

An alternative is to run the microcontroller at a higher clock rate and put it into shutdown between readings, allowing the use of the digital output. In this approach the ADXL210E should be set at its fastest sample rate (T2 = 0.5 ms), with a 500 Hz filter at X_{FILT} and Y_{FILT}. The concept is to acquire a reading as quickly as possible and then shut down the ADXL210E and the microcontroller until the next sample is needed.

In either of the above approaches, the ADXL210E can be turned on and off directly using a digital port pin on the microcontroller to power the accelerometer without additional components.

CALIBRATING THE ADXL210E

The initial value of the offset and scale factor for the ADXL210E will require calibration for applications such as tilt measurement. The ADXL210E architecture has been designed so that these calibrations take place in the software of the microcontroller used to decode the duty cycle signal. Calibration factors can be stored in EEPROM or determined at turn-on and saved in dynamic memory.

For low g applications, the force of gravity is the most stable, accurate and convenient acceleration reference available. A reading of the 0 g point can be determined by orientating the device parallel to the earth's surface and then reading the output.

A more accurate calibration method is to make measurements at +1 g and -1 g. The sensitivity can be determined by the two measurements.

To calibrate, the accelerometer's measurement axis is pointed directly at the earth. The 1 g reading is saved and the sensor is turned 180° to measure -1 g. Using the two readings, the sensitivity is:

Let A = Accelerometer output with axis oriented to +1 g

Let B = Accelerometer output with axis oriented to -1 g then:

$$Sensitivity = [A - B]/2\text{ g}$$

For example, if the +1 g reading (A) is 55% duty cycle and the -1 g reading (B) is 47% duty cycle, then:

$$Sensitivity = [55\% - 47\%]/2\text{ g} = 4\%/g$$

These equations apply whether the output is analog or duty cycle.

Application notes outlining algorithms for calculating acceleration from duty cycle and automated calibration routines are available from the factory.

ADXL210E

OUTLINE DIMENSIONS

Dimensions shown in inches and (mm).

8-Terminal Ceramic Leadless Chip Carrier (E-8)

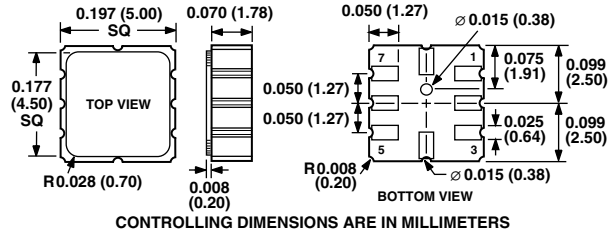

C02778-0-2/02(0)

PRINTED IN U.S.A.