



■ Features :

- High efficiency 94% and low power dissipation
- 150% peak load capability
- Built-in active PFC function, PF>0.93
- Protections: Short circuit / Overload / Over voltage / Over temperature
- Cooling by free air convection
- Can be installed on DIN rail TS-35/7.5 or 15
- UL 508 (industrial control equipment) approved
- EN61000-6-2(EN50082-2) industrial immunity level
- Built-in DC OK relay contact
- 100% full load burn-in test
- 3 years warranty



SPECIFICATION

MODEL		SDR-240-24	SDR-240-48
OUTPUT	DC VOLTAGE	24V	48V
	RATED CURRENT	10A	5A
	CURRENT RANGE	0 ~ 10A	0 ~ 5A
	RATED POWER	240W	240W
	PEAK CURRENT	15A	7.5A
	PEAK POWER <small>Note.6</small>	360W (3sec.)	
	RIPPLE & NOISE (max.) <small>Note.2</small>	50mVp-p	50mVp-p
	VOLTAGE ADJ. RANGE	24 ~ 28V	48 ~ 55V
	VOLTAGE TOLERANCE <small>Note.3</small>	± 1.0%	± 1.0%
	LINE REGULATION	± 0.5%	± 0.5%
	LOAD REGULATION	± 1.0%	± 1.0%
	SETUP, RISE TIME	650ms, 60ms/230VAC 1300ms, 60ms/115VAC at full load	
HOLD UP TIME (Typ.)	20ms/230VAC 20ms/115VAC at full load		
INPUT	VOLTAGE RANGE	88 ~ 264VAC	124 ~ 370VDC
	FREQUENCY RANGE	47 ~ 63Hz	
	POWER FACTOR (Typ.)	0.94/230VAC	0.99/115VAC at full load
	EFFICIENCY (Typ.) <small>Note.8</small>	94%	
	AC CURRENT (Typ.)	2.6A/115VAC	1.3A/230VAC
	INRUSH CURRENT (Typ.)	33A/115VAC	55A/230VAC
LEAKAGE CURRENT	<1mA/ 240VAC		
PROTECTION	OVERLOAD	Normally works within 110 ~ 150% rated output power for more than 3 seconds and then shut down o/p voltage with auto-recovery >150% rated power, constant current limiting with auto-recovery within 2 seconds and may cause to shut down if over 2 seconds	
	OVER VOLTAGE	29 ~ 33V	56 ~ 65V
	OVER TEMPERATURE	95°C ± 5°C (TSW : detect on heatsink of power switch) Protection type : Shut down o/p voltage, recovers automatically after temperature goes down	
FUNCTION	DC OK REALY CONTACT RATINGS (max.)	60Vdc/0.3A, 30Vdc/1A, 30Vac/0.5A resistive load	
ENVIRONMENT	WORKING TEMP. <small>Note.5</small>	-25 ~ +70°C (Refer to "Derating Curve")	
	WORKING HUMIDITY	20 ~ 95% RH non-condensing	
	STORAGE TEMP., HUMIDITY	-40 ~ +85°C, 10 ~ 95% RH	
	TEMP. COEFFICIENT	± 0.03%/°C (0 ~ 50°C)	
	VIBRATION	Component:10 ~ 500Hz, 2G 10min./1cycle, 60min. each along X, Y, Z axes; Mounting: Compliance to IEC60068-2-6	
SAFETY & EMC <small>(Note 4)</small>	SAFETY STANDARDS	UI508, TUV EN60950-1 approved;(meet EN60204-1)	
	WITHSTAND VOLTAGE	I/P-O/P:3KVAC I/P-FG:2KVAC O/P-FG:0.5KVAC O/P-DC OK:0.5KVAC	
	ISOLATION RESISTANCE	I/P-O/P, I/P-FG, O/P-FG:>100M Ohms / 500VDC / 25°C / 70% RH	
	EMC EMISSION	Compliance to EN55011, EN55032 (CISPR32), EN61204-3 Class B, EN61000-3-2,-3	
OTHERS	EMC IMMUNITY	Compliance to EN61000-4-2,3,4,5,6,8,11, EN55024, EN61000-6-2 (EN50082-2), EN61204-3, heavy industry level, criteria A, SEMI F47, GL approved	
	MTBF	169.3K hrs min. MIL-HDBK-217F (25°C)	
	DIMENSION	63*125.2*113.5mm (W*H*D)	
	PACKING	1.03Kg; 12pcs/13.4Kg/1.06CUFT	
NOTE	<ol style="list-style-type: none"> 1. All parameters NOT specially mentioned are measured at 230VAC input, rated load and 25°C of ambient temperature. 2. Ripple & noise are measured at 20MHz of bandwidth by using a 12" twisted pair-wire terminated with a 0.1uf & 47uf parallel capacitor. 3. Tolerance : includes set up tolerance, line regulation and load regulation. 4. The power supply is considered a component which will be installed into a final equipment. The final equipment must be re-confirmed that it still meets EMC directives. 5. Installation clearances : 40mm on top, 20mm on the bottom, 5mm on the left and right side are recommended when loaded permanently with full power. In case the adjacent device is a heat source, 15mm clearance is recommended. 6. 3 seconds max., please refer to peak loading curves. 7. Derating may be needed under low input voltage. Please check the derating curve for more details. 8. After 30 minutes of burn-in. 		

Mechanical Specification

Case No. 979A Unit:mm

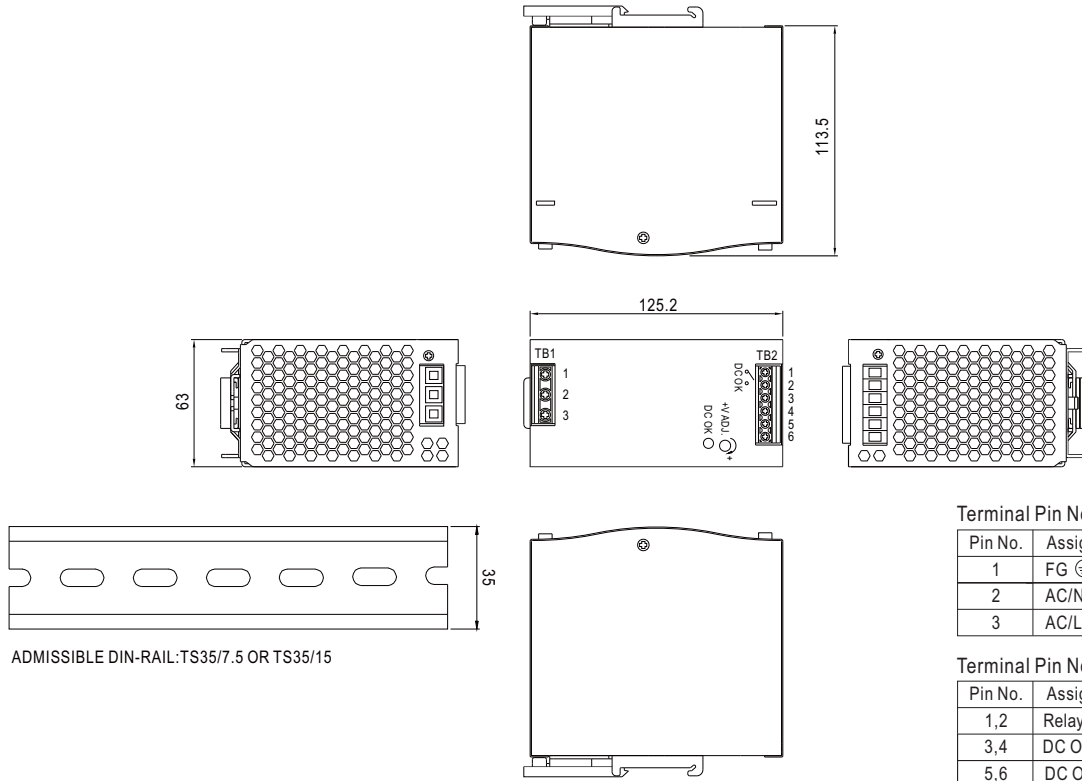

Terminal Pin No. Assignment (TB1)

Pin No.	Assignment
1	FG ⊕
2	AC/N
3	AC/L

Terminal Pin No. Assignment (TB2)

Pin No.	Assignment
1,2	Relay Contact
3,4	DC OUTPUT +V
5,6	DC OUTPUT -V

Block Diagram

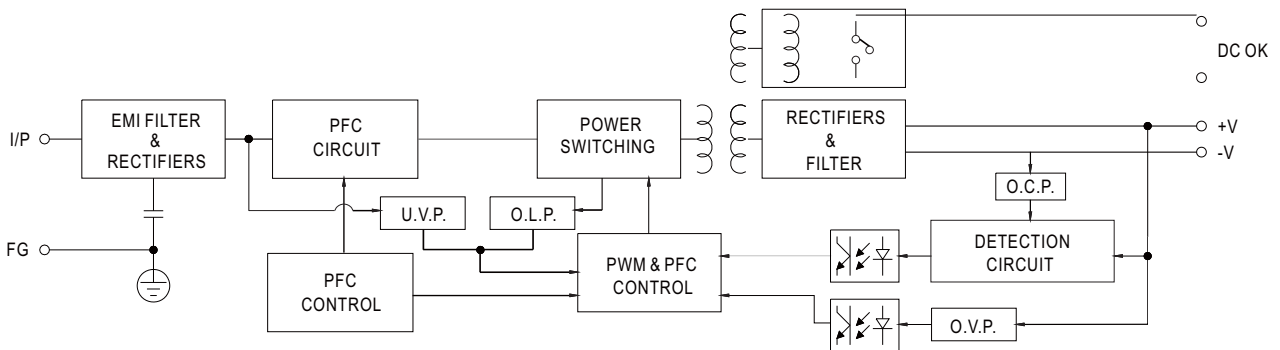

DC OK Relay Contact

Contact Close	PSU turns on / DC OK.
Contact Open	PSU turns off / DC Fail.
Contact Ratings (max.)	30V/1A resistive load.

■ Peak Loading

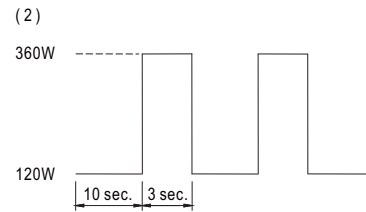
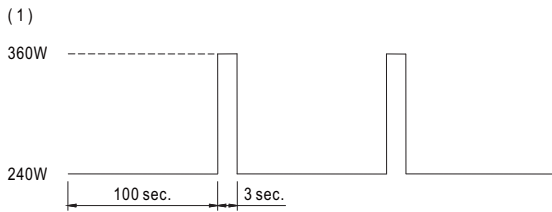

■ Derating Curve

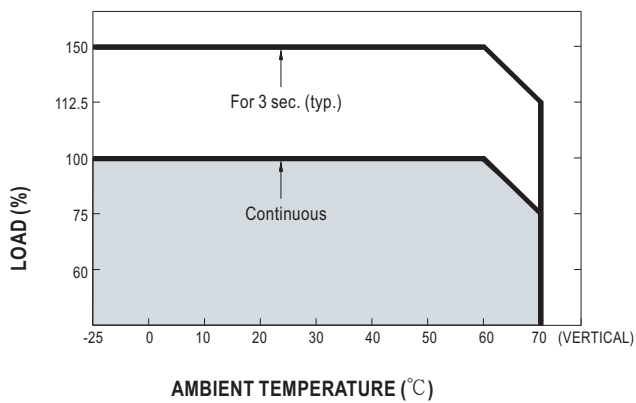

■ Output derating VS input voltage

