

## PSoC® Development Tools Selector Guide

For the CY8C29x66, CY8C27x43, CY8C24x94, CY8C24x23A, CY8C21x34, and CY8C21x23

There is a Cypress Development kit for every need – from entry-level evaluation and prototyping, to full-speed, real-time emulation and debugging, to high volume manufacturing programming.

### Software

PSoC software is available for free download at <http://www.cypress.com>.

#### PSoC Designer

At the core of the PSoC development software suite is PSoC Designer™. Utilized by thousands of PSoC developers, this robust software has been facilitating PSoC designs for half a decade.

<http://www.cypress.com/psocdesigner>

There are three subsystems within PSoC Designer:

1. Device Editor: Configure PSoC hardware blocks and IO, route internal signals, and define system parameters.
2. Application Editor: Write application code in 'C' or assembly language. (A fully integrated C compiler is accessible with the purchase of a license.)
3. Debugger: Debug using breakpoints, trace, watch variables, advanced dynamic event points, and more.

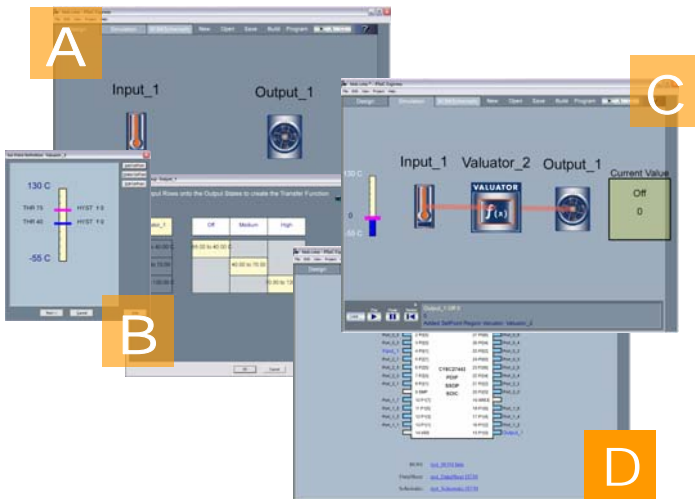
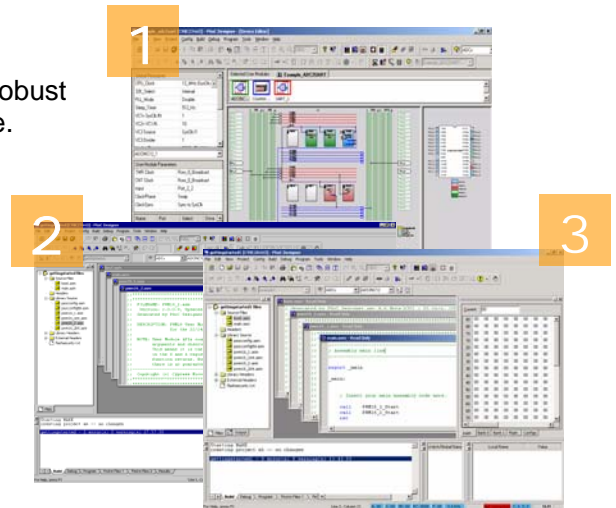

#### PSoC Express

As the newest addition to the PSoC development software suite, PSoC Express™ is the first visual embedded system design tool that allows a user to create an entire PSoC project and generate a schematic, BOM, and data sheet without writing a single line of code. Users work directly with application objects such as LEDs, switches, sensors, and fans.

- Select inputs and outputs (A)
- Define the output's behavior (B)
- Simulate the design to verify (C)
- Build to generate PSoC HEX file, BOM, schematic, and datasheet (D)

<http://www.cypress.com/psocexpress>

#### PSoC Programmer

Flexible enough to be used on the bench in development, yet suitable for factory programming, PSoC Programmer works either as a standalone programming application or it can operate directly from PSoC Designer or PSoC Express.

PSoC Programmer is the one-stop programming application for Cypress' PSoC development tools.

<http://www.cypress.com/psocprogrammer>

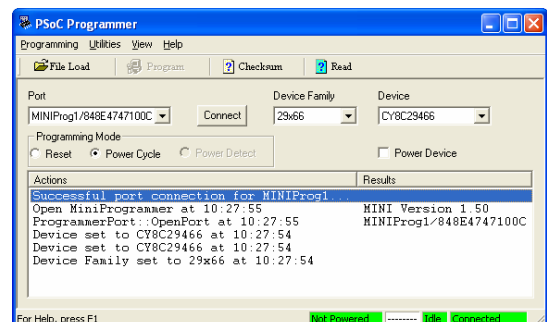

# Basic Development Kit

## CY3215-DK Basic Development Kit

Everything you need to get started with PSoC, with support for the 28-pin DIP package.

- PSoC Designer Software CD-ROM
- ICE-Cube In-Circuit Emulator
- ICE Flex-Pod for CY8C29x66 Family
- Backward Compatible Cat-5 Adapter
- Mini-Eval Programming Board in One
- 110 ~ 240V Power Supply, Euro-Plug Adapter
- iMAGEcraft C Compiler (Registration Required)
- ISSP Cable
- USB 2.0 Cable and Blue Cat-5 Cable
- 2 CY8C29466-24PXI 28-PDIP Chip Samples



### ICE-Cube

The ICE-Cube (available in the CY3215-DK) is driven by the Debugger subsystem of PSoC Designer. This software interface allows users to run, halt, and single step the processor and view the content of specific memory locations. It also allows the user to set complex event points. Event points can start and stop the trace memory on the ICE, as well as break the program execution. The ICE-Cube supports large memory model PSoC devices (devices with >256 bytes of RAM) and is backward compatible with previous PSoC devices (CY8C27x43 and CY8C24x23A).

### CY3202-C iMAGEcraft C Compiler

The C compiler is included in the CY3215-DK. For use with other kits, the CY3202-C is available as a separate purchase. It is fully integrated into PSoC Designer. PSoC Designer provides source-level debugging to round out its 'C' language support. (No C compiler purchase is necessary for using PSoC Express.)

- ANSI C compiler
- Inline assembly and interface with assembly modules
- Modern stack-based architecture
- 7 basic data types including IEEE 32-bit floating point
- Assembler and linker
- Math and string libraries
- 'C' interrupt service routines
- Librarian



## Express Development Kit

### CY3210-ExpressDK PSoC Express Development Kit

The CY3210-ExpressDK is for advanced prototyping and development with PSoC Express. It provides access to I2C buses, voltage references, switches, upgradeable modules and more.

- PSoC Express Software CD-ROM
- Express Development Board
- 4 Fan Modules
- 2 Proto Modules
- MiniProg In-System Serial Programmer
- MiniEval PCB Evaluation Board
- Jumper Wire Kit
- USB 2.0 Cable
- Serial Cable (DB9)
- 110 ~ 240V Power Supply, Euro-Plug Adapter
- 2 CY8C24423A-24PXI 28-PDIP Chip Samples
- 2 CY8C27443-24PXI 28-PDIP Chip Samples
- 2 CY8C29466-24PXI 28-PDIP Chip Samples

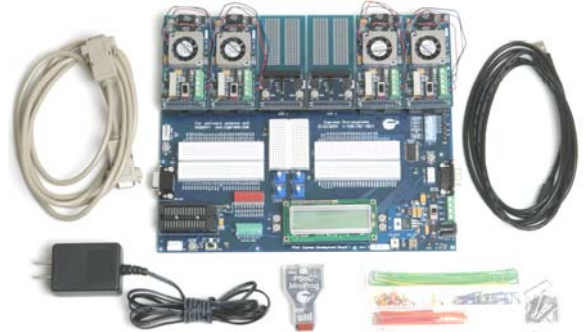

<http://www.cypress.com/expressdk>

### CY3210-FanMod Fan Module Kit

This kit provides two extra fan modules for use with the CY3210-ExpressDK.



### CY3210-ProtoMod Proto Module Kit

This kit provides two extra proto modules for use with the CY3210-ExpressDK.

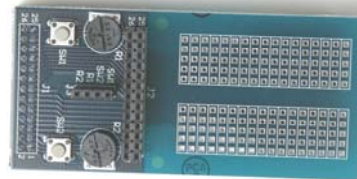

## Emulation Kits and Accessories

### PSoC Emulation Accessories Overview

The following tables can be used to associate a specific PSoC part with its appropriate Development Kit, Emulation Kit, and Programmer Kit.

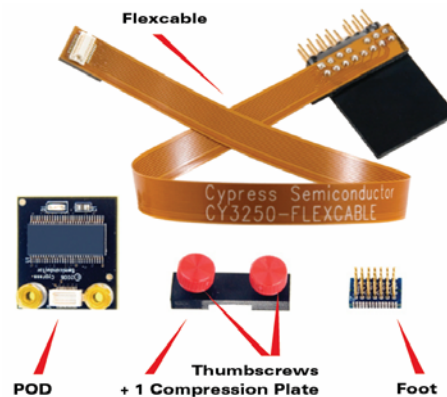

- |                          |  |
|--------------------------|--|
| ▪ QFN Emulation Kit:     | 1 Flexcable, 1 Pod, 2 Feet (See Appendix for detail) |
| ▪ Non-QFN Emulation Kit: | 1 Flexcable, 1 Pod, 2 Feet (See Appendix for detail) |
| ▪ Pod Kit:               | 2 Pods   |
| ▪ Foot Kit:              | 4 Feet   |
| ▪ Flexcable Kit:         | 1 Flexcable  |

All PDIP packages can be programmed with ISSP or MiniProg (up to 28PDIP) without programming adapter. For other packages, please refer to the Programming Adapter table on page 7.

Chip Part #	Package	Dev. Kit	Emulation Kit	Foot Kit	Programmer**
CY8C29466-24PXI	28 PDIP	CY3215-DK	CY3250-29XXX	CY3250-28PDIP-FK	ISSP or MiniProg
CY8C29466-24PVXI	28 SSOP	CY3215-DK	CY3250-29XXX	CY3250-28SSOP-FK*	ISSP or MiniProg
CY8C29466-24SXI	28 SOIC	CY3215-DK	CY3250-29XXX	CY3250-28SOIC-FK*	ISSP or MiniProg
CY8C29566-24AXI	44 TQFP	CY3215-DK	CY3250-29XXX	CY3250-44TQFP-FK*	ISSP or MiniProg
CY8C29666-24PVXI	48 SSOP	CY3215-DK	CY3250-29XXX	CY3250-48SSOP-FK*	ISSP or MiniProg
CY8C29666-24LFXI	48 QFN	CY3215-DK	CY3250-29XXXQFN	CY3250-48QFN-FK	ISSP or MiniProg
CY8C29866-24AXI	100 TQFP	CY3215-DK	CY3250-29XXX	CY3250-100TQFP-FK*	ISSP or MiniProg

\*Foot Kit is required in conjunction with Emulation Kit to emulate this package.

\*\*Programming adapter may be required.

Chip Part #	Package	Dev. Kit	Emulation Kit	Foot Kit	Programmer**
CY8C24794-24LFXI	56 QFN	CY3215-DK	CY3250-24X94QFN	CY3250-56QFN-FK	ISSP or MiniProg
CY8C24894-24LFXI	56 QFN	CY3215-DK	CY3250-24X94QFN	CY3250-56QFN-FK	ISSP or MiniProg

\*\*Programming adapter may be required.

Chip Part #	Package	Dev. Kit	Emulation Kit	Foot Kit	Programmer**
CY8C21234-24SXI	16 SOIC	CY3215-DK	CY3250-21X34	CY3250-16SOIC-FK*	ISSP or MiniProg
CY8C21334-24PVXI	20 SSOP	CY3215-DK	CY3250-21X34	CY3250-20SSOP-FK	ISSP or MiniProg
CY8C21434-24LFXI	32 QFN	CY3215-DK	CY3250-21X34QFN	CY3250-32QFN-FK	ISSP or MiniProg
CY8C21534-24PVXI	28 SSOP	CY3215-DK	CY3250-21X34	CY3250-28SSOP-FK	ISSP or MiniProg
CY8C21634-24LFXI	32 QFN	CY3215-DK	CY3250-21X34QFN	CY3250-32QFN-FK	ISSP or MiniProg

\*Foot Kit is required in conjunction with Emulation Kit to emulate this package.

\*\*Programming adapter may be required.

Chip Part #	Package	Dev. Kit	Emulation Kit	Foot Kit	Programmer**
CY8C21123-24SXI	8 SOIC	CY3215-DK	CY3250-21X23	CY3250-8SOIC-FK*	ISSP or MiniProg
CY8C21223-24SXI	16SOIC	CY3215-DK	CY3250-21X23	CY3250-16SOIC-FK*	ISSP or MiniProg
CY8C21323-24PVXI	20 SSOP	CY3215-DK	CY3250-21X23	CY3250-20SSOP-FK	ISSP or MiniProg
CY8C21323-24LFXI	24 QFN	CY3215-DK	CY3250-21x23QFN	CY3250-24QFN-FK	ISSP or MiniProg

\*Foot Kit is required in conjunction with Emulation Kit to emulate this package.

\*\*Programming adapter may be required.

Chip Part #	Package	Dev. Kit	Emulation Kit	Foot Kit	Programmer**
CY8C27143-24PXI	8 PDIP	CY3215-DK	CY3250-27XXX	CY3250-8PDIP-FK*	ISSP or MiniProg
CY8C27243-24PVXI	20 SSOP	CY3215-DK	CY3250-27XXX	CY3250-20SSOP-FK*	ISSP or MiniProg
CY8C27243-24SXI	20 SOIC	CY3215-DK	CY3250-27XXX	CY3250-20SOIC-FK*	ISSP or MiniProg
CY8C27443-24PXI	28 PDIP	CY3215-DK	CY3250-27XXX	CY3250-28PDIP-FK	ISSP or MiniProg
CY8C27443-24PVXI	28 SSOP	CY3215-DK	CY3250-27XXX	CY3250-28SSOP-FK*	ISSP or MiniProg
CY8C27443-24SXI	28 SOIC	CY3215-DK	CY3250-27XXX	CY3250-28SOIC-FK*	ISSP or MiniProg
CY8C27543-24AXI	44 TQFP	CY3215-DK	CY3250-27XXX	CY3250-44TQFP-FK*	ISSP or MiniProg
CY8C27643-24PVXI	48 SSOP	CY3215-DK	CY3250-27XXX	CY3250-48SSOP-FK*	ISSP or MiniProg
CY8C27643-24LFXI	48 QFN	CY3215-DK	CY3250-27XXXQFN	CY3250-48QFN-FK	ISSP or MiniProg

\*Foot Kit is required in conjunction with Emulation Kit to emulate this package.

\*\*Programming adapter may be required.

Chip Part #	Package	Dev. Kit	Emulation Kit	Foot Kit	Programmer**
CY8C24123A-24PXI	8 PDIP	CY3215-DK	CY3250-24X23A	CY3250-8PDIP-FK*	ISSP or MiniProg
CY8C24123A-24SXI	8 SOIC	CY3215-DK	CY3250-24X23A	CY3250-8SOIC-FK*	ISSP or MiniProg
CY8C24223A-24PXI	20 PDIP	CY3215-DK	CY3250-24X23A	CY3250-20PDIP-FK*	ISSP or MiniProg
CY8C24223A-24PVXI	20 SSOP	CY3215-DK	CY3250-24X23A	CY3250-20SSOP-FK*	ISSP or MiniProg
CY8C24223A-24SXI	20 SOIC	CY3215-DK	CY3250-24X23A	CY3250-20SOIC-FK*	ISSP or MiniProg
CY8C24423A-24PXI	28 PDIP	CY3215-DK	CY3250-24X23A	CY3250-28PDIP-FK	ISSP or MiniProg
CY8C24423A-24PVXI	28 SSOP	CY3215-DK	CY3250-24X23A	CY3250-28SSOP-FK*	ISSP or MiniProg
CY8C24423A-24SXI	28 SOIC	CY3215-DK	CY3250-24X23A	CY3250-28SOIC-FK*	ISSP or MiniProg
CY8C24423A-24LFXI	32 QFN	CY3215-DK	CY3250-24X23AQFN	CY3250-32QFN-FK	ISSP or MiniProg

\*Foot Kit is required in conjunction with Emulation Kit to emulate this package.

\*\*Programming adapter may be required.

# Evaluation Tools

## Overview

There are three types of general evaluation methods for the PSoC. The picture below illustrates the device path for these three methods:

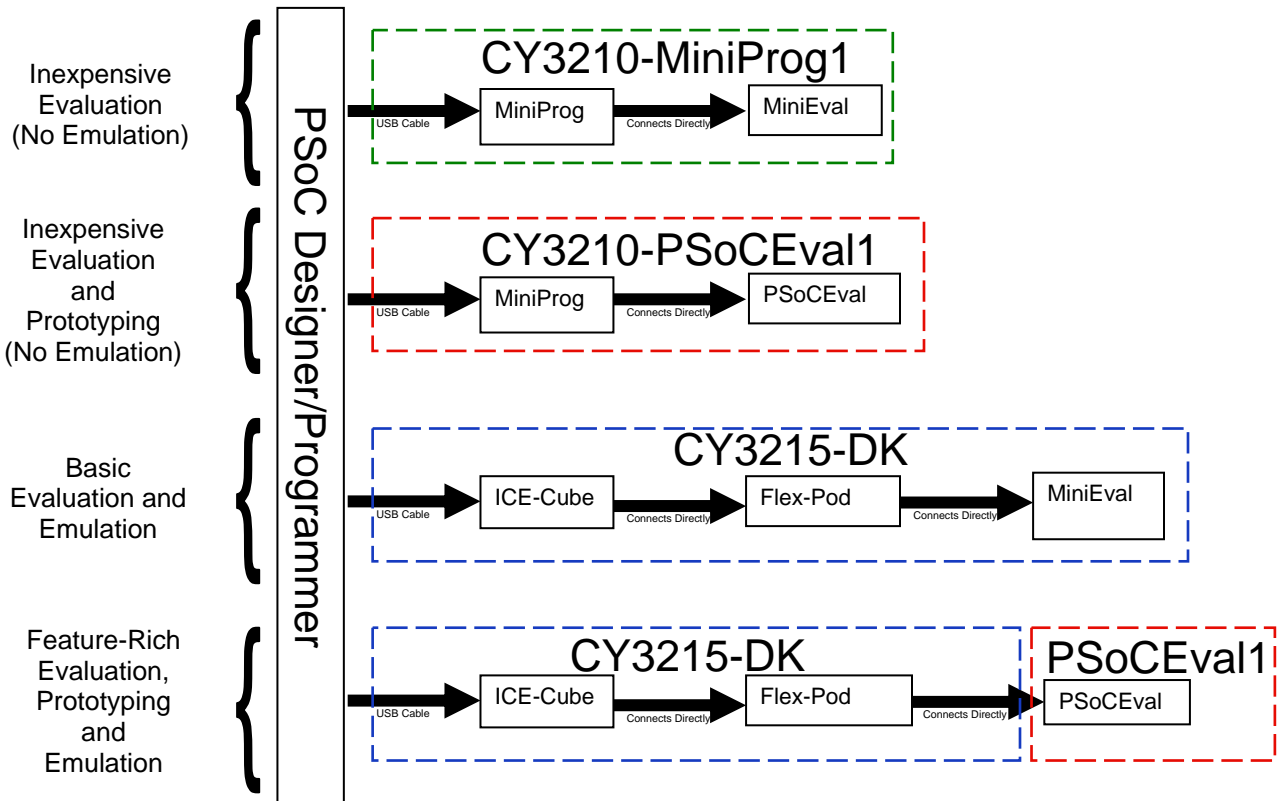

## CY3210-MiniProg1

This inexpensive evaluation kit allows a user to program PSoC devices via the MiniProg1 programming unit. A MiniEval1 board is also included in the kit. The MiniEval board is a programming and evaluation board that allows socket programming of DIP devices. It also includes LEDs and a POT for simple evaluation and demonstration, but does not include a prototyping area. The MiniProg utilizes a 5-pin ISSP (In-System Serial Programming) header to program PSoC devices on the MiniEval board or directly on a target board. (To learn how to prepare your target board for ISSP, see Application Note AN2014 available at <http://www.cypress.com>.) The MiniProg is small, compact, and connects to the PC via a provided USB 2.0 cable.



### Kit Includes:

- MiniProg Programming Unit
- MiniEval Socket Programming and Evaluation Board
- 28-Pin CY8C29466-24PXI PDIP PSoC Device Sample
- 28-Pin CY8C27443-24PXI PDIP PSoC Device Sample
- PSoC Designer Software CD
- Getting Started Guide
- USB 2.0 Cable

Note that the MiniProg is intended as a programming tool for the developer.

## CY3210-PSoCEval1

This evaluation kit features an evaluation board and MiniProg1 programming unit. The evaluation board includes an LCD module, Potentiometer, LEDs, and plenty of breadboarding space to meet all of your evaluation needs. The MiniProg1 programming unit will program PSoC devices directly on the evaluation board or on other boards via a 5-pin header. The MiniProg1 is small and compact, and connects to a PC via a provided USB 2.0 Cable.



### Kit Includes:

- Evaluation Board with LCD Module
- MiniProg Programming Unit
- 28-Pin CY8C29466-24PXI PDIP PSoC Device Sample (2)
- PSoC Designer Software CD
- Getting Started Guide
- USB 2.0 Cable

## CY3214-PSoCEvalUSB (Support for CY8C24894 Coming Soon)

This new evaluation kit is specifically for the CY8C24794. It includes an evaluation board and MiniProg1 programming unit. The evaluation board features an On-Chip Debugger (OCD). The OCD allows full-featured, on-board emulation of the CY8C24794 when combined with an ICE-Cube (available in the CY3215-DK). The board also features USB connectivity and CapSense™ buttons and slider. Also included on the board is an LCD module, potentiometer, LEDs, an enunciator, and plenty of breadboarding space to meet all of your evaluation needs.



### Kit Includes:

- CY8C24794 Evaluation Board with LCD Module
- MiniProg Programming Unit
- PSoC Designer Software CD
- PSoC Support CD (with CY8C24794 Example Projects)
- Getting Started Guide
- USB 2.0 Cable

# Programming Methods

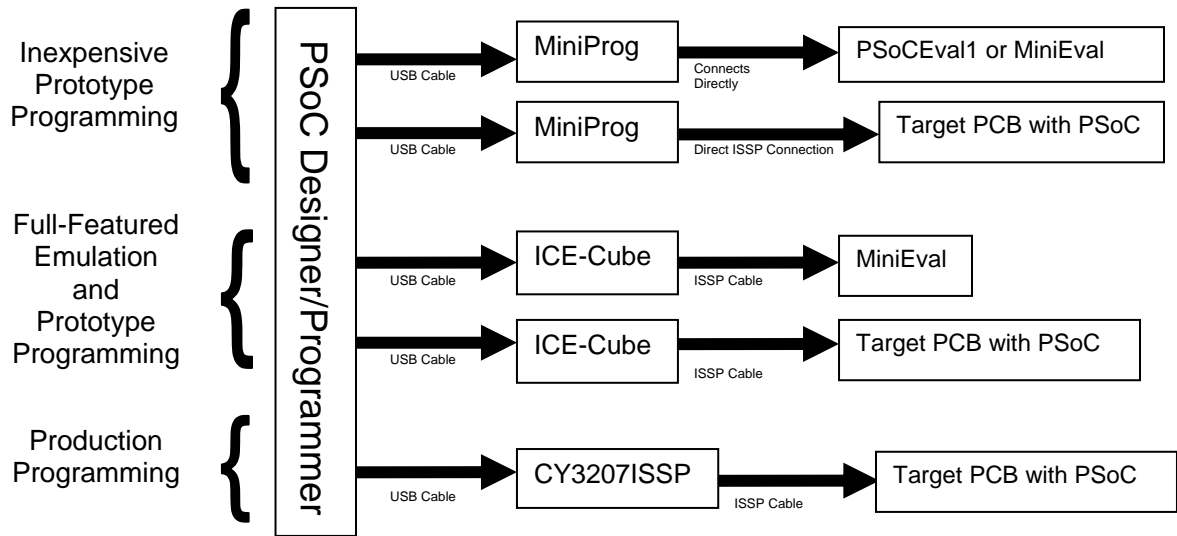

## CY3207ISSP

The CY3207ISSP is a production programmer. It includes protection circuitry and an industrial case that is more robust than the MiniProg and the ICE-Cube in a production-programming environment. The CY3207ISSP can program parts in-system or mounted in the socket. Use the table to the right to identify adapters for CY3207ISSP socket programming.

PSoC Foot Print	Emulation Technologies P/N
8-Pin SOIC	AS-08-08-01S-3
16-Pin SOIC	AS-16-16-02S-3
20-Pin SOIC	AS-20-20-01S-3-GANG
28-Pin SOIC	AS-28-28-02S-3
20-Pin SSOP	AS-20-20-01SS-3
24-Pin QFN	AS-24-28-01ML-6
28-Pin SSOP	AS-28-28-02SS-6ENP-GANG
32-Pin QFN	AS-32-28-03ML-6
44-Pin QFN	AS-44-28-03Q-6
48-Pin QFN	AS-48-28-02ML-6
48-Pin SSOP	AS-48-48-01SS-6-GANG
56-Pin QFN	AS-56-28-01ML-6
100-Pin TQFP	AS-100-28-01TQ-6

## ISSP Overview

The CY3207ISSP, ICE-Cube, and MiniProg1 all allow easy In-System Serial Programming (ISSP). A black cable is included in the Development Kit for ISSP. All designers are encouraged to design their PCBs with an ISSP capability.

ISSP is perfect for prototyping because it allows rapid reprogramming of the PSoC part mounted on the PCB and eliminates the need for a package-specific YProgrammer. ISSP can also be useful in production programming because it eliminates the need for programming individual chips prior to PCB assembly. Often times ISSP is cheaper than using a programming house.



Pictured to the right is an ICE-Cube connected directly to a project PCB (the PSoCEval). ISSP can be done with the small ISSP connector. An ISSP connector is pictured to the left. See Application Notes AN2014 and AN2026, AN2026a, AN2026b for more information on ISSP.



## 3<sup>rd</sup>-Party Tools

Several tools have been specially designed to accompany PSoC devices during development and production by the following 3<sup>rd</sup>-party vendors. Specific details for each of these tools can be found online under **Evaluation Boards >> PSoC** at <http://www.cypress.com>.

**Device Programmer Leap Electronic CO., LTD.**

<http://www.leap.com.tw/>

**3rd-Party ISSP Programmer SONmicro**

<http://www.sonmicro.com>

**3rd-Party Programmer Xeltek Inc.**

<http://www.xeltek.com>

**PSoC ISP, Arista Systems**

<http://www.aristasystems.com/psocisp.htm> or [sales@aristasystems.com](mailto:sales@aristasystems.com)

**3rd-Party Development Tool mikroElektronika PSoC System**

<http://www.mikroelektronika.co.yu/english/product/tools/psocds.htm>

**In-System Programming/PSoC Development System, MikroElektronika**

<http://www.mikroelektronika.co.yu/english/product/tools/psocprog.htm>

**PSoC Evaluation Kit, McGilvra Engineering**

<http://www.mcgilvra.com/>

**Device Programmer System General Corporation**

<http://www.systemgeneral.com/>

**Device Programmer HI-LO SYSTEMS**

<http://www.hilosystems.com.tw/>

**Device Programmer BP Microsystems**

<http://www.bpmicro.com>

**Device Programmer Data I/O**

<http://www.data-io.com/default.asp>

**3rd-Party ISSP Programmer MPQ Manufacturing**

<http://www.rpmsys.com/>



# Appendix

## CY3250 Development Tool

Part Number	Function	Content	Price
CY3250-FLEXCABLE	Replacement Flexcable for PSoC CY3250 ICE Pod Kit	One (1) Flexcable	\$38.00
CY3250-24X94QFN	Emulation support for CY8C24794-24LFXI and CY8C24894-24LFXI devices. The QFN pod provides the interconnection between the ICE base unit and the target hardware, includes 56-QFN Feet (2).	One (1) 24X94QFN POD One (1) Flexcable Two (2) 56QFN Feet	\$135.00
CY3250-24X23AQFN	Emulation support for CY8C24423A-LFXI device. The QFN pod provides the interconnection between the ICE base unit and the target hardware, includes 32-QFN Feet (2).	One (1) 24X23AQFN POD One (1) Flexcable Two (2) 32QFN Feet	\$135.00
CY3250-27XXXQFN	Emulation support for CY8C27643-LFXI device. The QFN pod provides the interconnection between the ICE base unit and the target hardware, includes 48-QFN Feet (2).	One (1) 27XXXQFN POD One (1) Flexcable Two (2) 48QFN Feet	\$135.00
CY3250-29XXXQFN	Emulation support for CY8C29666-LFXI device. The QFN pod provides the interconnection between the ICE base unit and the target hardware, includes 48-QFN Feet (2).	One (1) 29XXXQFN POD One (1) Flexcable Two (2) 48QFN Feet	\$135.00
CY3250-21X23QFN	Emulation support for CY8C21323-LFXI device. The QFN pod provides the interconnection between the ICE base unit and the target hardware, includes 24-QFN Feet (2).	One (1) 21X23QFN POD One (1) Flexcable Two (2) 24QFN Feet	\$135.00
CY3250-21X34QFN	Emulation support for CY8C21434-LFXI and CY8C21634-LFXI devices. The QFN pod provides the interconnection between the ICE base unit and the target hardware, includes 32-QFN Feet (2).	One (1) 21X34 QFN POD One (1) Flexcable Two (2) 32QFN Feet	\$135.00
CY3250-24QFN-FK	Replacement PSoC CY3250 (24-pin QFN) Pod Feet	Four (4) 24QFN Feet	\$140.00
CY3250-32QFN-FK	Replacement PSoC CY3250 (32-pin QFN) Pod Feet	Four (4) 32QFN Feet	\$140.00
CY3250-48QFN-FK	Replacement PSoC CY3250 (48-pin QFN) Pod Feet	Four (4) 48QFN Feet	\$140.00
CY3250-56QFN-FK	Replacement PSoC CY3250 (56-pin QFN) Pod Feet	Four (4) 56QFN Feet	\$140.00
CY3250-24X94QFN-POD	Replacement PSoC CY3250-24x94QFN Pod	Two (2) 24X94QFN Pod	\$78.00
CY3250-24X23AQFN-POD	Replacement PSoC CY3250-24x23AQFN Pod	Two (2) 24X23AQFN Pod	\$78.00
CY3250-27XXXQFN-POD	Replacement PSoC CY3250-27XXXQFN Pod	Two (2) 27XXXQFN Pod	\$78.00
CY3250-29XXXQFN-POD	Replacement PSoC CY3250-29XXXQFN Pod	Two (2) 29XXXQFN Pod	\$78.00
CY3250-21X23QFN-POD	Replacement PSoC CY3250-21X23QFN Pod	Two (2) 21X23QFN Pod	\$78.00
CY3250-21X34QFN-POD	Replacement PSoC CY3250-21X34QFN Pod	Two (2) 21X34QFN Pod	\$78.00
CY3250-24X23A	Emulation support for CY8C24x23A devices. The pod provides the interconnection between the ICE base unit and the target hardware, includes 28PDIP Feet (2). This pod kit supports all non-QFN packages in combination with available CY3250 foot kit.	One (1) 24X23A POD One (1) Flexcable Two (2) 28PDIP Feet	\$135.00
CY3250-27XXX	Emulation support for CY8C27x43 devices. The pod provides the interconnection between the ICE base unit and the target hardware, includes 28PDIP Feet (2). This pod kit supports all non-QFN packages in combination with available CY3250 foot kit.	One (1) 27XXX POD One (1) Flexcable Two (2) 28PDIP Feet	\$135.00
CY3250-29XXX	Emulation support for CY8C29x66 devices. The pod provides the interconnection between the ICE base unit and the target hardware, includes 28PDIP Feet (2). This pod kit supports all non-QFN packages in combination with available CY3250 foot kit.	One (1) 29XXX POD One (1) Flexcable Two (2) 28PDIP Feet	\$135.00
CY3250-21X23	Emulation support for CY8C21x23 devices. The pod provides the interconnection between the ICE base unit and the target hardware, includes 20SSOP Feet (2). This pod kit supports all non-QFN packages in combination with available CY3250 foot kit.	One (1) 21X23 POD One (1) Flexcable Two (2) 20SSOP Feet	\$135.00
CY3250-21X34	Emulation support for CY8C21x34 devices. The pod provides the interconnection between the ICE base unit and the target hardware, includes 28SSOP Feet (2). This pod kit supports all non-QFN packages in combination with available CY3250 foot kit.	One (1) 21X34 POD One (1) Flexcable Two (2) 28SSOP Feet	\$135.00
CY3250-20PDIP-FK	Replacement PSoC CY3250 (20-pin DIP) Pod Feet	Four (4) 20PDIP Feet	\$140.00
CY3250-28PDIP-FK	Replacement PSoC CY3250 (28-pin DIP) Pod Feet	Four (4) 28PDIP Feet	\$140.00
CY3250-8PDIP-FK	Replacement PSoC CY3250 (8-pin DIP) Pod Feet	Four (4) 8PDIP Feet	\$140.00
CY3250-16SOIC-FK	Replacement PSoC CY3250 (16-pin SOIC) Pod Feet	Four (4) 16SOIC Feet	\$140.00
CY3250-20SOIC-FK	Replacement PSoC CY3250 (20-pin SOIC) Pod Feet	Four (4) 20SOIC Feet	\$140.00
CY3250-28SOIC-FK	Replacement PSoC CY3250 (28-pin SOIC) Pod Feet	Four (4) 28SOIC Feet	\$140.00
CY3250-8SOIC-FK	Replacement PSoC CY3250 (8-pin SOIC) Pod Feet	Four (4) 8SOIC Feet	\$140.00
CY3250-20SSOP-FK	Replacement PSoC CY3250 (20-pin SSOP) Pod Feet	Four (4) 20SSOP Feet	\$140.00
CY3250-28SSOP-FK	Replacement PSoC CY3250 (28-pin SSOP) Pod Feet	Four (4) 28SSOP Feet	\$140.00
CY3250-48SSOP-FK	Replacement PSoC CY3250 (48-pin SSOP) Pod Feet	Four (4) 48SSOP Feet	\$140.00
CY3250-100TQFP-FK	Replacement PSoC CY3250 (100-pin TQFP) Pod Feet	Four (4) 100TQFP Feet	\$180.00
CY3250-44TQFP-FK	Replacement PSoC CY3250 (44-pin TQFP) Pod Feet	Four (4) 44TQFP Feet	\$140.00
CY3250-24X94-POD	Replacement PSoC CY3250-24x94 Pod	Two (2) 24X94 Pod	\$78.00
CY3250-24X23A-POD	Replacement PSoC CY3250-24X23A Pod	Two (2) 24X23A Pod	\$78.00
CY3250-27XXX-POD	Replacement PSoC CY3250-27XXX Pod	Two (2) 27XXX Pod	\$78.00
CY3250-29XXX-POD	Replacement PSoC CY3250-29XXX Pod	Two (2) 29XXX Pod	\$78.00
CY3250-21X23-POD	Replacement PSoC CY3250-21X23 Pod	Two (2) 21X23 Pod	\$78.00
CY3250-21X34-POD	Replacement PSoC CY3250-21X34 Pod	Two (2) 21X34 Pod	\$78.00

For information and support on PSoC devices: <http://www.cypress.com/psoc>.  
Items may be purchased online at the Cypress Online Store: <http://www.cypress.com/> home page.  
Or you can purchase Development Tools from one of Cypress' accredited distributors.

Cypress Semiconductor  
198 Champion Court  
San Jose, CA 95134-1709  
Phone: 408-943-2600  
Fax: 408-943-4730  
<http://www.cypress.com>

© Cypress Semiconductor Corporation, 2006. The information contained herein is subject to change without notice. Cypress Semiconductor Corporation assumes no responsibility for the use of any circuitry other than circuitry embodied in a Cypress product. Nor does it convey or imply any license under patent or other rights. Cypress products are not warranted nor intended to be used for medical, life support, life saving, critical control or safety applications, unless pursuant to an express written agreement with Cypress. Furthermore, Cypress does not authorize its products for use as critical components in life-support systems where a malfunction or failure may reasonably be expected to result in significant injury to the user. The inclusion of Cypress products in life-support systems application implies that the manufacturer assumes all risk of such use and in doing so indemnifies Cypress against all charges.

Revision \*H October 25, 2006

# Mouser Electronics

Authorized Distributor

Click to View Pricing, Inventory, Delivery & Lifecycle Information:

## Cypress Semiconductor:

[CY3250-20PDIP-FK](#) [CY3250-20SSOP-FK](#) [CY3250-21X23](#) [CY3250-21X23-POD](#) [CY3250-21X23QFN](#) [CY3250-21X23QFN-POD](#) [CY3250-21X34](#) [CY3250-21X34-POD](#) [CY3250-21X34QFN](#) [CY3250-21X34QFN-POD](#) [CY3250-24X23A](#) [CY3250-24X23A-POD](#) [CY3250-24X23AQFN](#) [CY3250-24X23AQFN-POD](#) [CY3250-27XXXQFN](#) [CY3250-27XXXQFN-POD](#) [CY3250-28PDIP-FK](#) [CY3250-29XXX-POD](#) [CY3250-29XXXQFN](#) [CY3250-29XXXQFN-POD](#) [CY3250-32QFN-FK](#) [CY3250-48QFN-FK](#) [CY3250-56QFN-FK](#) [CY3250-16SOIC-FK](#) [CY3250-100TQFP-FK](#) [CY3250-8SOIC-FK](#)