

POSITIONS/ CONTACTS	A		B	
	MM±0.20	[INCH±0.008]	MM±0.30	[INCH±0.012]
02/02	1.00	0.039	2.50	0.098
03/03	2.00	0.079	3.50	0.138
04/04	3.00	0.118	4.50	0.177
05/05	4.00	0.157	5.50	0.217
06/06	5.00	0.197	6.50	0.256
07/07	6.00	0.236	7.50	0.295
08/08	7.00	0.276	8.50	0.335
09/09	8.00	0.315	9.50	0.374
10/10	9.00	0.354	10.50	0.413
11/11	10.00	0.394	11.50	0.453
12/12	11.00	0.433	12.50	0.492
13/13	12.00	0.472	13.50	0.531
14/14	13.00	0.512	14.50	0.571
15/15	14.00	0.551	15.50	0.610
16/16	15.00	0.591	16.50	0.650
17/17	16.00	0.630	17.50	0.689
18/18	17.00	0.669	18.50	0.728
19/19	18.00	0.709	19.50	0.768
20/20	19.00	0.748	20.50	0.807
21/21	20.00	0.787	21.50	0.846
22/22	21.00	0.827	22.50	0.886
23/23	22.00	0.866	23.50	0.925
24/24	23.00	0.906	24.50	0.965
25/25	24.00	0.945	25.50	1.004
26/26	25.00	0.984	26.50	1.043
27/27	26.00	1.024	27.50	1.083
28/28	27.00	1.063	28.50	1.122
29/29	28.00	1.102	29.50	1.161
30/30	29.00	1.142	30.50	1.201
31/31	30.00	1.181	31.50	1.240
32/32	31.00	1.220	32.50	1.280
33/33	32.00	1.260	33.50	1.319
34/34	33.00	1.299	34.50	1.358
35/35	34.00	1.339	35.50	1.398
36/36	35.00	1.378	36.50	1.437
37/37	36.00	1.417	37.50	1.476
38/38	37.00	1.457	38.50	1.516
39/39	38.00	1.496	39.50	1.555
40/40	39.00	1.535	40.50	1.594
41/41	40.00	1.575	41.50	1.634
42/42	41.00	1.614	42.50	1.673
43/43	42.00	1.654	43.50	1.713
44/44	43.00	1.693	44.50	1.752
45/45	44.00	1.732	45.50	1.791
46/46	45.00	1.772	46.50	1.831
47/47	46.00	1.811	47.50	1.870
48/48	47.00	1.850	48.50	1.909
49/49	48.00	1.890	49.50	1.949
50/50	49.00	1.929	50.50	1.988

### PART NUMBER CODING

## SFM210-LP\_E-S\_-S\_-BK

#### MOUNTING STYLES

- C - SURFACE MOUNT, SINGLE ROW  
PIN 1 (STANDARD)
- D - SURFACE MOUNT, SINGLE ROW  
PIN 1 (OPPOSITE BEND)

**NUMBER OF POSITIONS**  
(CONTACTS PER ROW, 2 THRU 50)

#### PLATING

- P = GOLD FLASH OVERALL.
- S = 10u" GOLD OVERALL.

REVISIONS				
REV.	ECO. NO	DESCRIPTION	DATE	BY
A	1910	INITIAL RELEASE	2/5/2009	JH

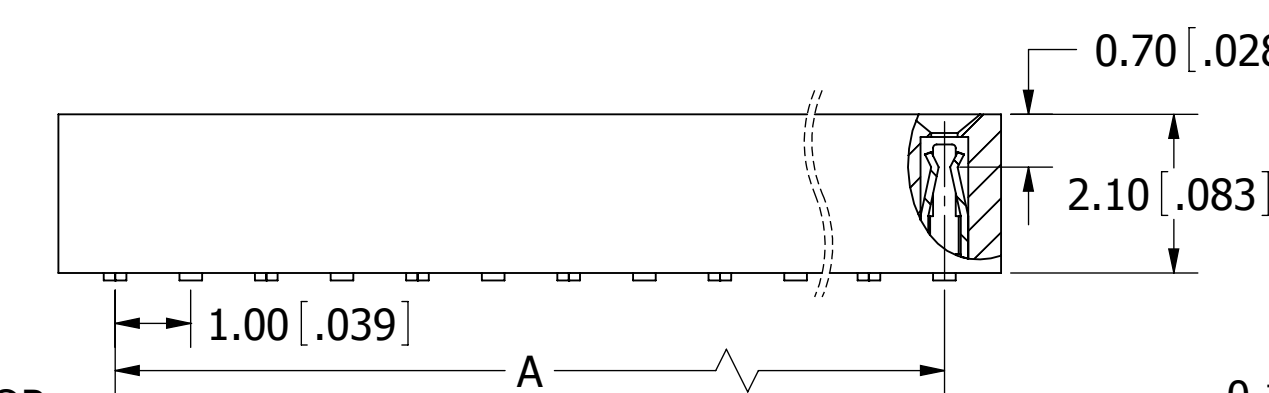
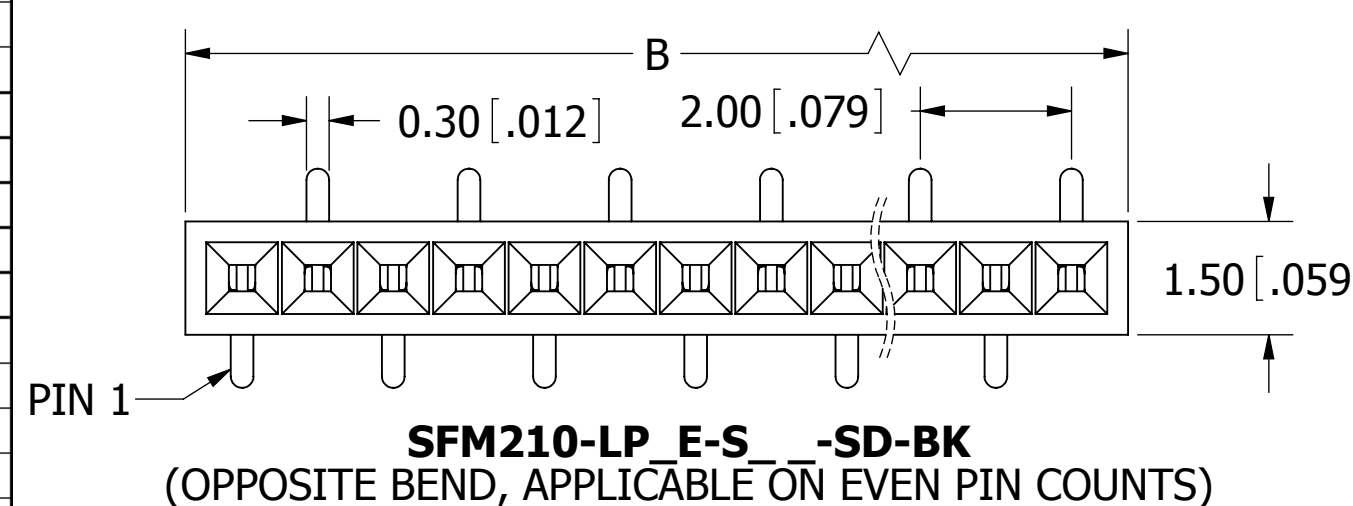
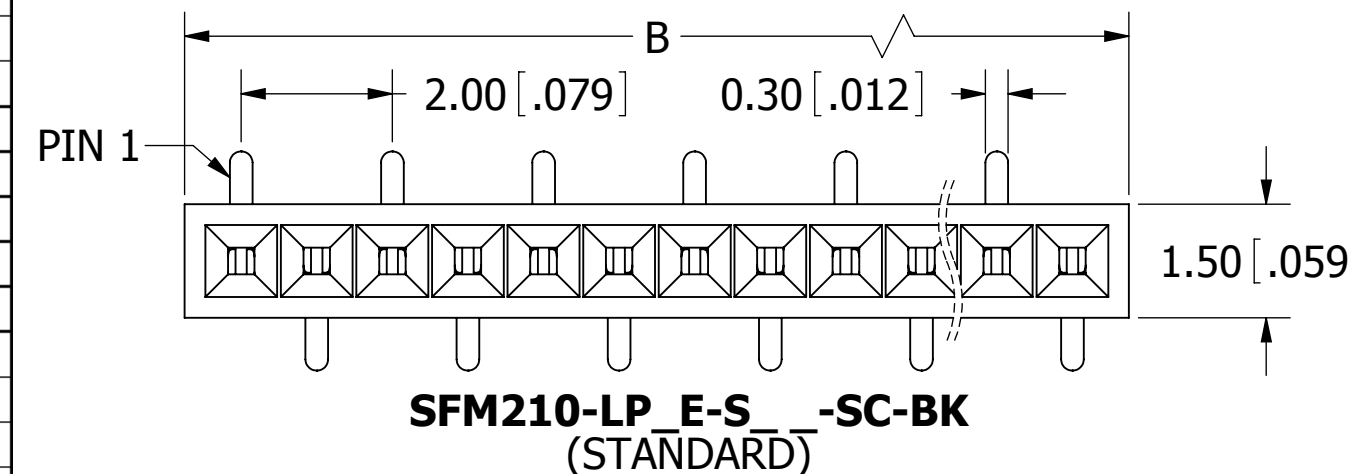
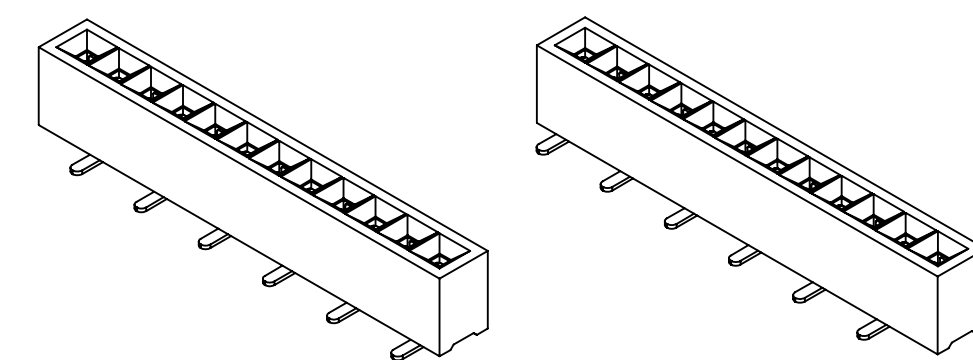

02-20, 0.20mm MAX.  
21-50, 0.30mm MAX.

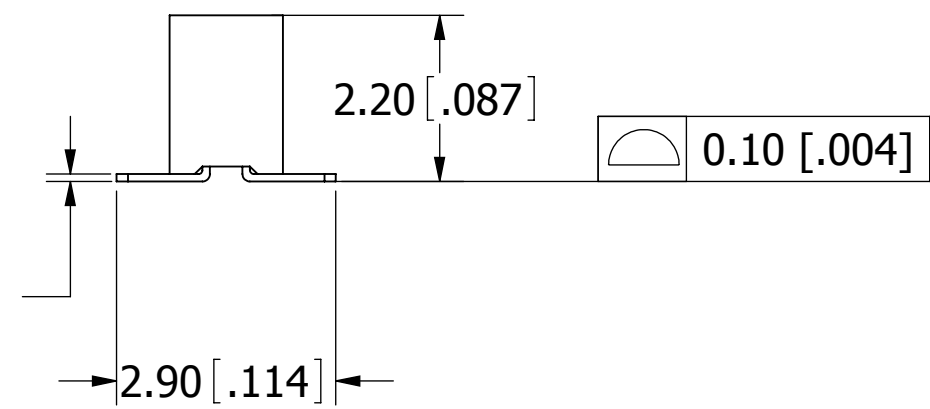
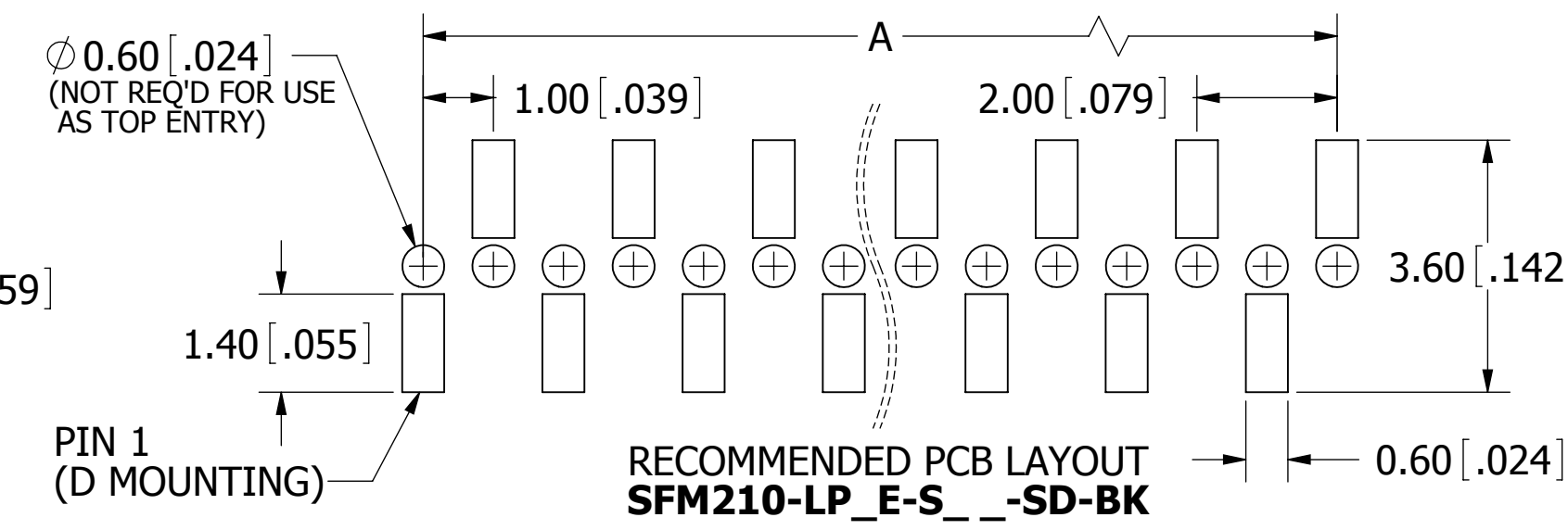
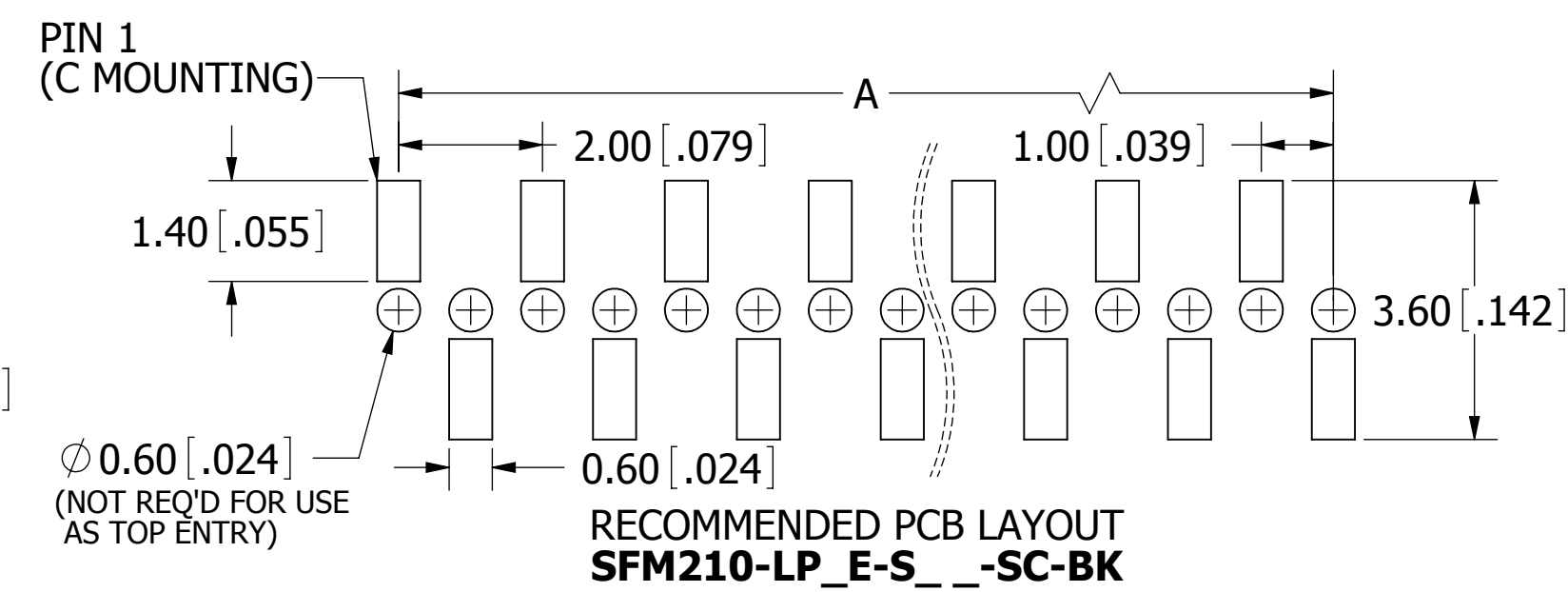

- NOTES:**
- INSULATOR MATERIAL: L.C.P, UL 94V-0, BLACK COLOR.
  - CONTACT MATERIAL: PHOSPHOR BRONZE.
  - CONTACT PLATING: SEE PART NUMBER CODING.
  - CURRENT RATING: 1 AMP.
  - INSULATOR RESISTANCE: 1000 MEGA OHMS MIN.
  - CONTACT RESISTANCE: 20 MILLI OHMS MAX.
  - DIELECTRIC WITHSTANDING: AC 300V.
  - OPERATING TEMPERATURE: -40° C TO +125° C.
  - PROCESSING TEMP.: 260° C FOR 10 SECS MAX.  
(INDICATED TEMPERATURE AND TIME IS FOR COMPONENT INSULATOR. HIGHER PROCESSING TEMPERATURES MAY BE USED, PROVIDED HEAT IS APPLIED FROM BACK SIDE OF PCB, AND INSULATOR DOES NOT EXCEED INDICATED TEMPERATURE AND TIME.)
  - FOR TOP/BOTTOM ENTRY.
  - CONSULT FACTORY FOR THE MATE IF BEING USED AS BOTTOM ENTRY.



UNLESS OTHERWISE SPECIFIED:  
DIMENSIONS ARE IN MM(INCHES)  
TOLERANCES:  
ANGULAR: ± 5°  
.X= ± .30 [.012]  
.XX= ± .20 [.008]  
.XXX= ± .10 [.004]  
SURFACE FINISH: 63 R<sub>a</sub>  
REMOVE ALL BURRS AND SHARP EDGES .010 MAX

INTERPRET DIMENSIONS AND GEOMETRIC TOLERANCING PER: ANSI Y14.5M-1994

DRAWN	2/05/09	JH
THE INFORMATION HEREIN CONTAINS PROPRIETARY INFORMATION OF SULLINS ELECTRONICS AND IS NOT TO BE REPRODUCED, USED OR DISCLOSED TO OTHERS FOR ANY PURPOSE EXCEPT AS SPECIFICALLY AUTHORIZED IN WRITING BY AN OFFICER OF SULLINS ELECTRONICS.		
DESCRIPTION HEADER, FEMALE 1mm CC, 1 ROW, SMT		
PART NUMBER <b>SFM210-LP_E-S_-S_-BK</b>		
SIZE	DWG. NO.	REV
<b>C</b>	11198	<b>A</b>
SCALE: 16:1		SHEET 1 OF 1