

Ceramic Disc Capacitors (Safety Regulations)

Type NS-A IEC60384-14 Sub-class Y1/X1
Type TS IEC60384-14 Sub-class Y2/X1
Type VS IEC60384-14 Sub-class Y2/X1 Smaller size
Type BE 250 VAC Electrical Appliance and Material Safety Law compliance (Former Electrical Appliance and Material Control Law)

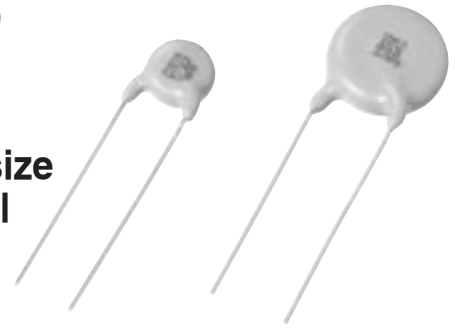

■ Features

- Related by IEC60384-14 2nd Ed. and approved by European Safety Regulations (Types NS-A, TS and VS)
- Reinforced Body Insulation /0.4mm min. approved by BSI, VDE (Type NS-A)
- Flame-retardant insulating coating applied
- Easy mounting through kinked Lead and Radial Taping

■ Recommended Applications

- Interference suppressor for AC Primary Line of electronic equipments.

■ Explanation of Part Numbers

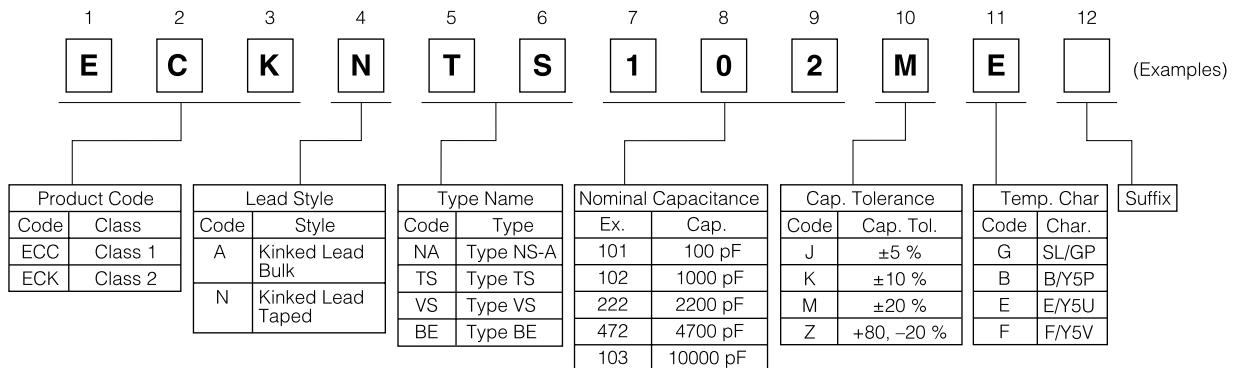

■ Specifications

Characteristics	Type NS-A	Type TS	Type VS	Type BE
Related Standards	IEC 60384-14(Y1/X1) BSI, VDE, SEV, SEMKO FIMKO, NEMKO, DEMKO UL, CSA, KTL	IEC 60384-14(Y2/X1) BSI, VDE, SEV, SEMKO FIMKO, NEMKO, DEMKO UL, CSA, KTL	IEC 60384-14(Y2/ X1) VDE, SEMKO, FIMKO NEMKO, DEMKO UL, KTL	Electrical Appliance and Material Safety Law compliance (Former Electrical Appliance and Material Control Law)
Operating Temperature Range	-25 to 125 °C			-25 to 105 °C
Rated Voltage	250 VAC/440 VAC			250 VAC
Dielectric Withstanding Voltage	4000 VAC for 1 minute	2600 VAC for 1 minute	1500 VAC for 1 minute	
Capacitance	Within the tolerance, when measured at 1 kHz ± 20 %, 1 Vrms, and 20 °C			
Dissipation Factor (tanδ)	tan δ ≤ 0.025, when measured at 1 kHz ± 20 %, 1 Vrms, and 20 °C			tan δ ≤ 0.025 for Char.E tan δ ≤ 0.05 for Char.F at 1 kHz ±20 %, 1 Vrms, and 20 °C
Insulation Resistance	10000 MΩ min at 500 VDC 1 minute electrification.			
Temperature Characteristics	Char.	max. Cap. Change	Temperature Range	
	SL/GP	+350 to -1000 ppm/°C	20 to 85 °C	
	B	±10 %	-25 to 85 °C	
	E	+20, -55 %	-25 to 85 °C	
	F	+30, -80 %	-25 to 85 °C	

■ Precautions for Handling

See Page 93 to 95

■ Packaging Information

See Page 96 to 97

■ Related Standards and Certificate Numbers

● Type NS-A

Certificated Body	Related Standard	Certificate Number	Sub-class	Rated Voltage	Dielectric Withstanding Voltage	Operating Temperature Range
BSI (UK)	EN 132 400:1994 Sub-class Y2 (IEC 60384-14 2nd Ed.)	226319	Y1, X1	Y1:250 VAC X1:440 VAC	Y1:4000 VAC X1:1892 VDC	-25 to 125°C
VDE (Germany)		087472				
SEV (Switzerland)		00.0587				
SEMKO (Sweden)		9918234/01-02				
FIMKO (Finland)		F1 13556				
NEMKO (Norway)		P99101676				
DEMKO (Denmark)		DK99-02495				
CQC (China)	GB/T14472 (IEC 60384-14 2nd Ed.)	CQC03001008315	-	250 VAC	1500 VAC	-25 to 85°C
KTL (Korea)	K60384-14 (IEC 60384-14 2nd Ed.)	SU03012-3002				
UL (USA)	UL1414	E62674				
CSA (Canada)	CSA C22.2 No.1	LR58064				

Note: Certification Number sometimes changes with the change of the approval contents and so on. CQC and KTL marks are indicated on the label.

● Type TS

Certificated Body	Related Standard	Certificate Number		Sub-class	Rated Voltage	Dielectric Withstanding Voltage	Operating Temperature Range
		Plant Code H	Plant Code M				
BSI (UK)	EN132 400:1994 Sub-class Y2 (IEC 60384-14 2nd Ed.)	228035		Y2, X1	Y2:250 VAC X1:440 VAC	Y2:1500 VAC X1:1892 VDC	-25 to 125°C
VDE (Germany)		1220129	118911				
SEV (Switzerland)		00.0588					
SEMKO (Sweden)		9618031/01(Y2)	9909196/01-02				
FIMKO (Finland)		9909191/01(X1)	F13324A1				
NEMKO (Norway)		P96102354(Y2)	P99101190				
DEMKO (Denmark)		P99101084(X1)	DK99-01749				
KTL (Korea)	K60384-14(IEC 60384-14 2nd Ed.)	SU03012-3001	SU03013-3002	-	250 VAC	1500 VAC	-25 to 85 °C
UL (USA)	UL 1414	E62674					
CSA (Canada)	CSA C22.2 No.1	LR58064	LR31605				

Note: Certification Number sometimes changes with the change of the approval contents and so on. KTL marks are indicated on the label.

● Type VS

Certificated Body	Related Standard	Certificate Number	Sub-class	Rated Voltage	Dielectric Withstanding Voltage	Operating Temperature Range
VDE (Germany)	EN 132 400:1994 Sub-class Y2 (IEC 60384-14 2nd Ed.)	123139	Y2, X1	Y2:250 VAC X1:440 VAC	Y2:1500 VAC X1:1892 VDC	-25 to 125°C
SEMKO (Sweden)		0042075/01-02				
FIMKO (Finland)		F116196				
NEMKO (Norway)		P00102412				
DEMKO (Denmark)		310308-01				
KTL (Korea)	K60384-14 (IEC 60384-14 2nd Ed.)	SU03013-3003	-	250 VAC	1500 VAC	-25 to 85°C
UL (USA)	UL1414*	E62674				
	CSA C22.2 No.1*					

Note: * is for Line-by-pass capacitors. Certification Number sometimes changes with the change of the approval contents and so on. KTL marks is indicated on the label. Certification contents are subject to differ in capacitance values.

■ Marking Examples (Ex. Type NS-A, 4700 pF)

Marking Items	Examples* (Marking of the face and the reverse)
Manufacturer's Identification	
Type Designation	
sub-class and Rated Voltage	
Capacitance	
Recognized Marking (Logo or Monogram)	BSI
	VDE
	SEV
	SEMKO
	FIMKO
	NEMKO
	DEMKO
UL	
CSA	
Plant Code	H
Date Code (Ex. Sep. 2001)	19

Note: * The actual marking is sometimes different from the above example with the change of the safety approval contents and so on.

■ Dimensions in mm (not to scale)

Standard lead style are kinked Lead and Kinked Lead Taping as below.

● Kinked Lead Type

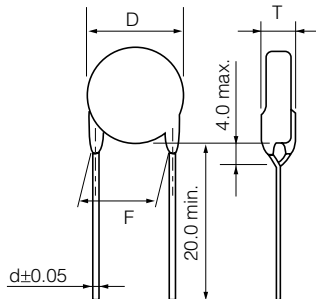

Note: Tolerance of Lead Space

Dim. F(Nominal)	Tolerance of Dim. F
5.0	±1.0
7.5	±1.5
10.0	±1.5 (^{+1.5} / _{-1.0} for Type NS-A)

● Kinked Lead Taping

Type N0, N1

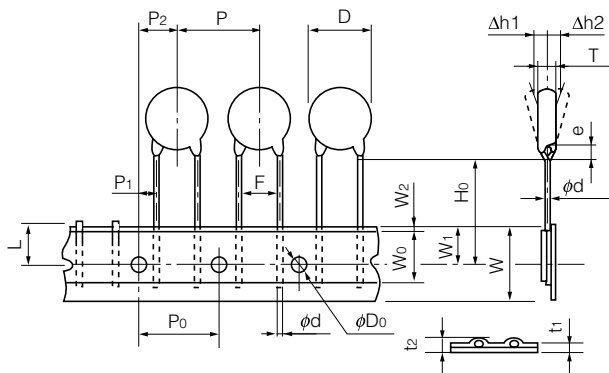

Type N2 *

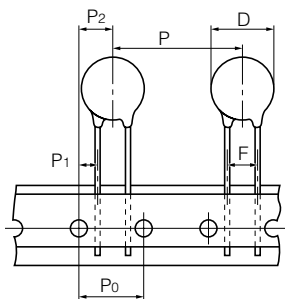

* Same dimensions as Type N0, N1 except for special dimensions.

Taping Type	N0	N1	N2
Symbol			
P	12.7±1.0	15.0±2.0	30.0±2.0
P ₀	12.7±0.3	15.0±0.3	
F	5.0±0.8	7.5±1.0	
P ₁	3.85±0.70	3.75±0.80	
P ₂	6.35±1.30	7.5±1.5	
D	To comply with each individual specification		
W	18.0 ^{+1.0} / _{-0.5}		
W ₀	10.0 min.		
W ₁	9.0±0.5		
W ₂	3.0 max.		
H ₀	18.0 ^{+2.0} / ₀		
e	4.0 max.		
ϕD ₀	4.0±0.2		
ϕd	0.60±0.05	0.65±0.05	
t ₁	0.6±0.3		
t ₂	1.5 max.		
T	To comply with each individual specification		
Δh ₁ , Δh ₂	2.0 max.		
L	11.0 max.		

Under kinked lead style are applied to only 3300 pF and over have a lead space (F) 7.5 mm of Type TS

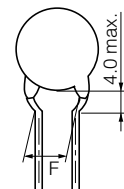

Rating and Characteristics

● Type NS-A (IEC60384-14 Sub-class Y1, X1) Rating and Characteristics

Cap. in pF	Cap. Tol. (%)	Temp. Char.	Dimensions in mm		Kinked Lead Type (Bulk)		
			D max.	T max.	Part Number	Dim. in mm	
						F	d
100	±10 or ±20	B	11.0	8.0	ECKANA101□B	10.0	0.65
150	±10 or ±20	B	11.0	8.0	ECKANA151□B	10.0	0.65
220	±10 or ±20	B	11.0	8.0	ECKANA221□B	10.0	0.65
330	±10 or ±20	B	11.0	8.0	ECKANA331□B	10.0	0.65
470	±10 or ±20	B	11.0	8.0	ECKANA471□B	10.0	0.65
680	±10 or ±20	B	11.0	8.0	ECKANA681□B	10.0	0.65
1000	±10 or ±20	B	11.0	8.0	ECKANA102□B	10.0	0.65
1000	±20	E	10.0	8.0	ECKANA102ME	10.0	0.65
1500	±20	E	11.0	8.0	ECKANA152ME	10.0	0.65
2200	±20	E	11.0	8.0	ECKANA222ME	10.0	0.65
3300	±20	E	13.0	8.0	ECKANA332ME	10.0	0.65
4700	±20	E	16.0	8.0	ECKANA472ME	10.0	0.65

Remark

·Type NS-A is approved by BSI and VDE for Reinforced Body Insulation (0.4 mm min.)

CB certification No.

BSI (UK)	GB386W
----------	--------

Certification No.

VDE (Germany)	087469
	087472

·Radial Taped version is available. (Lead space is available only in 10 mm)

□: Capacitance Tolerance Code
K:(±10 %) or M(±20 %)

● Type TS (IEC60384-14 Sub-class Y2, X1) Rating and Characteristics

Cap. in pF	Cap. Tol. (%)	Temp. Char.	Dimensions in mm		Kinked Lead Type (Bulk)			Kinked Lead Taped Type			
			D max. (Tol.)	T max.	Part Number	Dim. in mm		Part Number	Taped Type	Dim. in mm	
						F	d			F	d
100	±10 or ±20	B/Y5P	8.0(7.0±1.0)	7.0	ECKATS101□B	7.5	0.65	ECKNTS101□B	N1	7.5	0.65
150	±10 or ±20	B/Y5P	8.0(7.0±1.0)	7.0	ECKATS151□B	7.5	0.65	ECKNTS151□B	N1	7.5	0.65
220	±10 or ±20	B/Y5P	8.0(7.0±1.0)	7.0	ECKATS221□B	7.5	0.65	ECKNTS221□B	N1	7.5	0.65
330	±10 or ±20	B/Y5P	8.0(7.0±1.0)	7.0	ECKATS331□B	7.5	0.65	ECKNTS331□B	N1	7.5	0.65
470	±10 or ±20	B/Y5P	8.0(7.0±1.0)	7.0	ECKATS471□B	7.5	0.65	ECKNTS471□B	N1	7.5	0.65
680	±10 or ±20	B/Y5P	9.0(8.0±1.0)	7.0	ECKATS681□B	7.5	0.65	ECKNTS681□B	N1	7.5	0.65
1000	±10 or ±20	B/Y5P	10.5(9.5±1.0)	7.0	ECKATS102□B	7.5	0.65	ECKNTS102□B	N1	7.5	0.65
1000	±20	E/Y5U	8.0(7.0±1.0)	7.0	ECKATS102ME	7.5	0.65	ECKNTS102ME	N1	7.5	0.65
1500	±20	E/Y5U	9.0(8.0±1.0)	7.0	ECKATS152ME	7.5	0.65	ECKNTS152ME	N1	7.5	0.65
2200	±20	E/Y5U	9.5(9.0±1.0)	7.0	ECKATS222ME	7.5	0.65	ECKNTS222ME	N1	7.5	0.65
3300	±20	E/Y5U	12.5(11.5±1.0)	7.0	ECKATS332ME	7.5	0.65	ECKNTS332ME	N1	7.5	0.65
4700	±20	E/Y5U	15.0(14.0±1.0)	7.0	ECKATS472ME	10.0	0.65	ECKNTS472ME	N2	7.5	0.65
4700	±20	F/Y5V	12.5(11.5±1.0)	7.0	ECKATS472MF	7.5	0.65	ECKNTS472MF	N1	7.5	0.65
10000	±20	F/Y5V	17.0(16.0±1.5)	7.0	ECKATS103MF	10.0	0.65	ECKNTS103MF	N2	7.5	0.65

Note: □-- Capacitance Tolerance Code K (±10 %) or M(±20 %)

● Type VS (IEC60384-14 Sub-class Y2, X1 Smaller type) Rating and Characteristics

Cap. in pF	Capacitance Tolerance (%)	Temp. Char.	Dimensions in mm		Kinked Lead Type (Bulk)			Kinked Lead Taped Type			
			D max.	T max.	Part Number	Dim. in mm		Part Number	Taped Type	Dim. in mm	
						F	d			F	d
10	±0.5pF or ±1pF	SL/GP	8.0	6.0	ECCA VS100□G*	5.0	0.60	ECCNVS100□G*	N0	5.0	0.60
15	±5 or ±10	SL/GP	8.0	6.0	ECCA VS150□G*	5.0	0.60	ECCNVS150□G*	N0	5.0	0.60
22	±5 or ±10	SL/GP	8.0	6.0	ECCA VS220□G*	5.0	0.60	ECCNVS220□G*	N0	5.0	0.60
33	±5 or ±10	SL/GP	8.0	6.0	ECCA VS330□G*	5.0	0.60	ECCNVS330□G*	N0	5.0	0.60
47	±5 or ±10	SL/GP	8.0	6.0	ECCA VS470□G	5.0	0.60	ECCNVS470□G	N0	5.0	0.60
68	±5 or ±10	SL/GP	8.0	6.0	ECCA VS680□G	5.0	0.60	ECCNVS680□G	N0	5.0	0.60
100	±10 or ±20	B/Y5P	8.0	6.0	ECKA VS101□B	5.0	0.60	ECKNVS101□B	N0	5.0	0.60
150	±10 or ±20	B/Y5P	8.0	6.0	ECKA VS151□B	5.0	0.60	ECKNVS151□B	N0	5.0	0.60
220	±10 or ±20	B/Y5P	8.0	6.0	ECKA VS221□B	5.0	0.60	ECKNVS221□B	N0	5.0	0.60
330	±10 or ±20	B/Y5P	8.0	6.0	ECKA VS331□B	5.0	0.60	ECKNVS331□B	N0	5.0	0.60
470	±10 or ±20	B/Y5P	8.0	6.0	ECKA VS471□B	5.0	0.60	ECKNVS471□B	N0	5.0	0.60
680	±10 or ±20	B/Y5P	8.0	6.0	ECKA VS681□B	5.0	0.60	ECKNVS681□B	N0	5.0	0.60
1000	±20	E/Y5U	8.0	6.0	ECKA VS102ME	5.0	0.60	ECKNVS102ME	N0	5.0	0.60
1500	±20	E/Y5U	8.0	6.0	ECKA VS152ME	5.0	0.60	ECKNVS152ME	N0	5.0	0.60
2200	±20	E/Y5U	9.0	6.0	ECKA VS222ME	5.0	0.60	ECKNVS222ME	N0	5.0	0.60
3300	±20	E/Y5U	10.0	6.0	ECKA VS332ME	5.0	0.60	ECKNVS332ME	N0	5.0	0.60
4700	±20	E/Y5U	11.0	6.0	ECKA VS472ME	5.0	0.60	ECKNVS472ME	N0	5.0	0.60
4700	±20	F/Y5V	10.0	6.0	ECKA VS472MF	5.0	0.60	ECKNVS472MF	N0	5.0	0.60
10000	±20	F/Y5V	14.0	6.0	ECKA VS103MF	7.5	0.65	ECKNVS103MF	N1	7.5	0.65

Note 1: Dimensions "F"(Lead Space) of 7.5mm is available instead of 5.0 mm only by special order.

2: □-- Capacitance Tolerance Code D (±0.5 pF) or F (±1 pF) or J (±5 %) or K(±10 %) or M(±20 %)

3: * -- except for VDE and KTL.

- Type BE (250 VAC For Electrical Appliance and Material Safety Law compliance (Former Electrical Appliance and Material Control Law))

Cap. in pF	Cap. Tol. (%)	Temp. Char.	Dimensions in mm		Kinked Lead Type (Bulk)			Kinked Lead Taped Type			
			D max.	T max.	Part Number	Dim. in mm		Part Number	Taped Type	Dim. in mm	
						F	d			F	d
1000	+80, -20	E/Y5U	7.0	5.0	ECKABE102ZE	7.5	0.65	ECKNBE102ZE	N1	7.5	0.65
2200	+80, -20	E/Y5U	8.0	5.0	ECKABE222ZE	7.5	0.65	ECKNBE222ZE	N1	7.5	0.65
3300	+80, -20	E/Y5U	9.0	5.0	ECKABE332ZE	7.5	0.65	ECKNBE332ZE	N1	7.5	0.65
4700	+80, -20	E/Y5U	11.0	5.0	ECKABE472ZE	7.5	0.65	ECKNBE472ZE	N1	7.5	0.65
4700	+80, -20	F/Y5V	8.0	5.0	ECKABE472ZF	7.5	0.65	ECKNBE472ZF	N1	7.5	0.65
10000	+80, -20	F/Y5V	11.0	5.0	ECKABE103ZF	7.5	0.65	ECKNBE103ZF	N1	7.5	0.65

Note: Dimensions "F" (Lead space) of 5.0 mm is available instead of 7.5 mm by special order

■ Typical Temperature Characteristics (Type TS, and Type NS-A)

Char. B/Y5P)

(Temp. Range : -25 to 85°
max.Cap.Change : +10%)

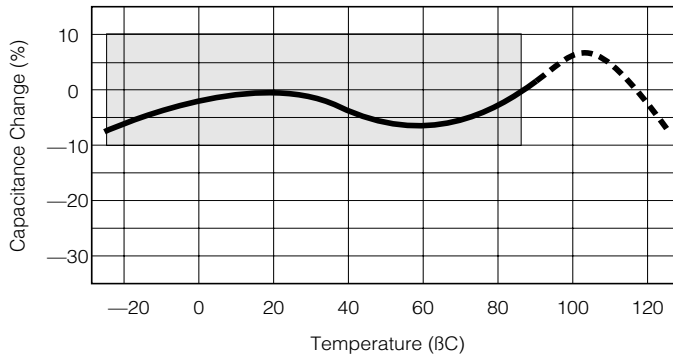

Char. E/Y5U)

(Temp. Range : -25 to 85°
max.Cap.Change : +20, -55%)

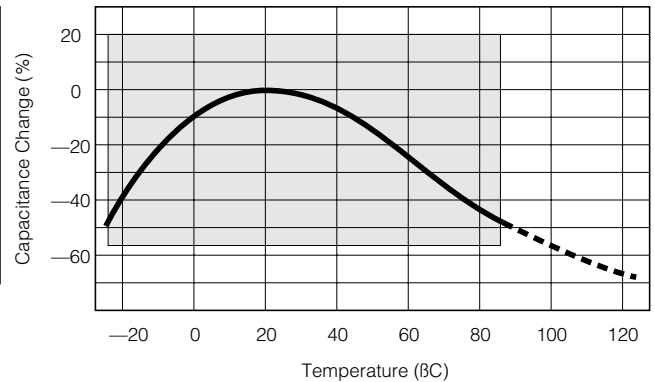

Char. F/Y5V)

(Temp. Range : -25 to 85°
max.Cap.Change : +30, -80%)

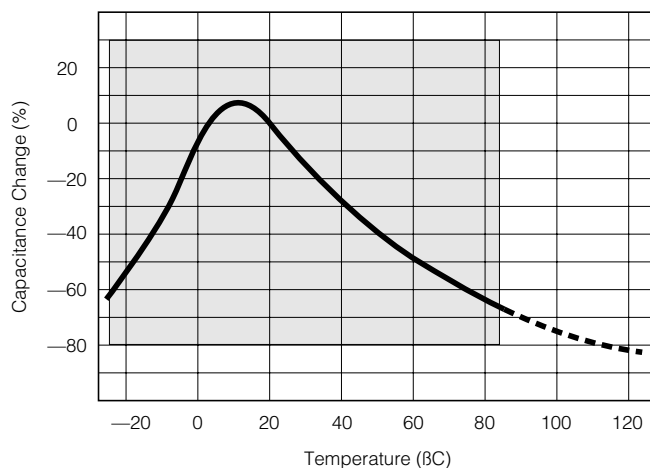

■ Impedance vs. Frequency Characteristics

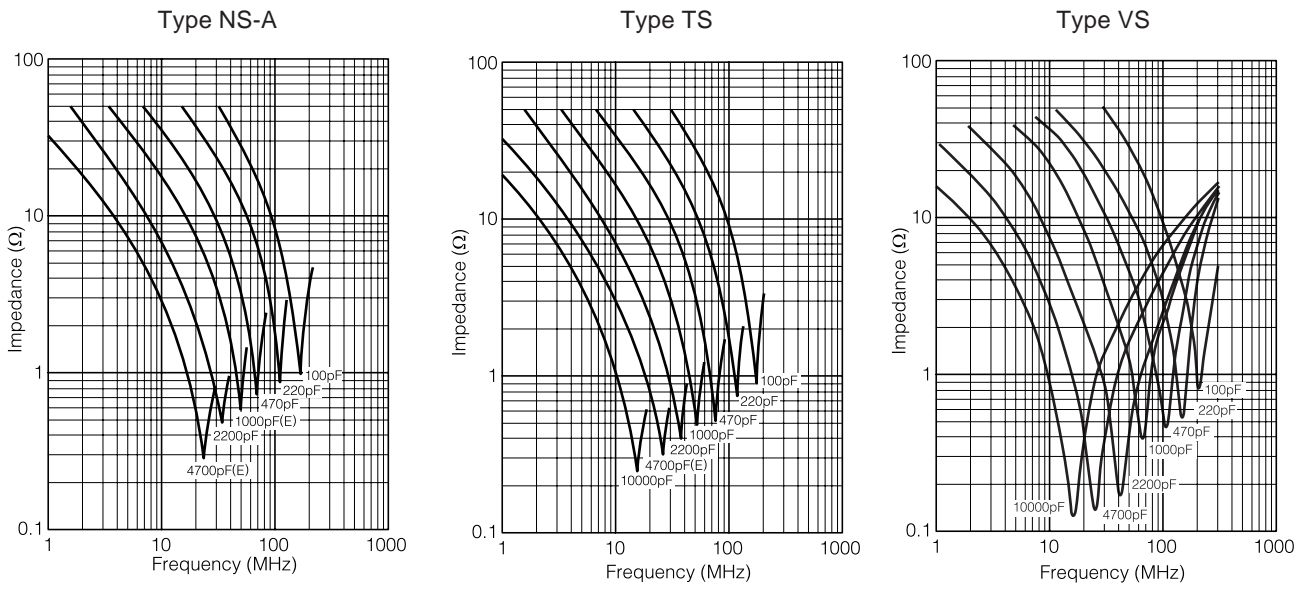

■ Current vs. Voltage (Leakage Current Characteristics)

Conditions Temperature: 20 °C, Applied Voltage: Sine Wave 60 Hz

