

Programmable Spread Spectrum Clock Generator for EMI Reduction

Features

- Wide Operating Output (SSCLK) Frequency Range
 - 3 to 200 MHz
- Programmable Spread Spectrum with Nominal 31.5 kHz modulation Frequency
- Center Spread: $\pm 0.25\%$ to $\pm 2.5\%$
- Down Spread: -0.5% to -5.0%
- Input Frequency Range
 - External crystal: 8 to 30 MHz fundamental crystals
 - External reference: 8 to 166 MHz clock
- Integrated Phase-Locked Loop (PLL)
- Programmable Crystal Load Capacitor Tuning Array
- Low Cycle-to-Cycle Jitter
- 3.3 V Operation with 2.5 V Output Clock Drive Option
- Spread Spectrum On and Off Function
- Power Down or Output Enable Function
- Output Frequency Select Option
- Field-Programmable
- Package: 16 Pin TSSOP

Description

The CY25200 is a programmable clock generator with spread spectrum capability. Spread spectrum modulates the output clock frequency over a small range, spreading the energy and reducing the energy peak. This is a powerful technique to reduce EMI in a variety of applications.

It uses either an external reference clock or a crystal for an input. It also uses a PLL to generate a spread spectrum output clock that can be a different frequency than the input. Up to six output clocks are available and up to two of them can be REFCLKs (copies of the input clock, without spread).

The CY25200 is highly configurable. Programmable variables include the input and output frequencies, spread percentage, center spread or down spread, and control pin functions. The oscillator pin capacitance can also be programmed to match the load capacitance requirement (C_L) of the crystal, eliminating the need for external capacitors.

Available features include Output Enable, Power Down, Spread On/Off, Frequency Select, and the option to power some output clocks at 2.5 V.

Cypress' web-based CyberClocks Online software is used to configure the device. Programmability enables fast prototyping, which is particularly useful when doing EMC testing and determining the optimal spread settings.

Logic Block Diagram

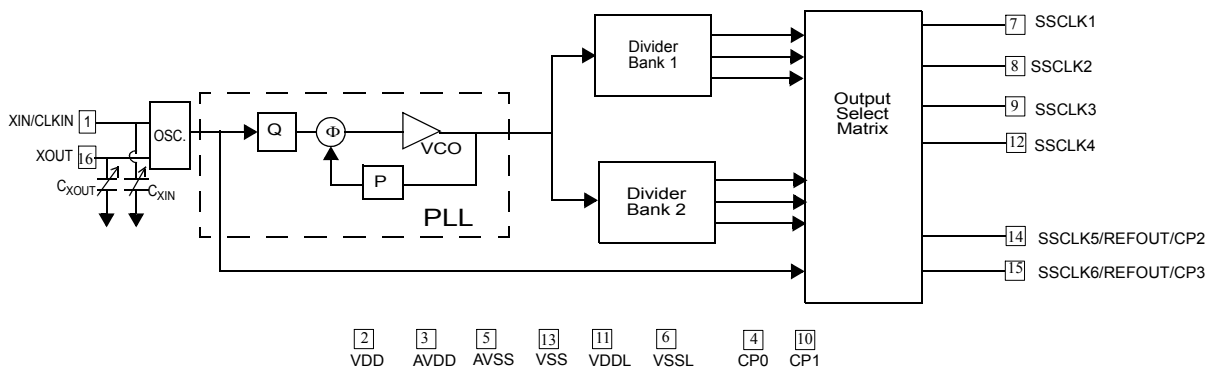

Contents

Pin Configuration	3	Absolute Maximum Rating	9
General Description	3	Recommended Crystal Specifications	9
Programming Description	4	Recommended Operating Conditions	9
Field-Programmable CY25200	4	DC Electrical Specifications	9
CyberClocks™ Online Software	4	AC Electrical Specifications	10
Factory-Programmed CY25200	4	Ordering Information	11
Product Functions	5	Possible Configurations	11
Control Pins (CP0, CP1, CP2 and CP3)	5	Ordering Code Definitions	11
Example	5	Package Drawing and Dimensions	12
CLKSEL	5	Acronyms	13
Input Frequency (XIN, Pin 1 and XOUT, Pin 16)	5	Document Conventions	13
CXIN and CXOUT (Pin 1 and Pin 16)	5	Units of Measure	13
Output Frequency	5	Document History Page	14
(SSCLK1 through SSCLK6 Outputs)	5	Sales, Solutions, and Legal Information	15
Spread Percentage (SSCLK1 to SSCLK6 Outputs)	6	Worldwide Sales and Design Support	15
Modulation Frequency	6	Products	15
Switching Waveforms	7	PSoC Solutions	15
Informational Graphs	8		

Pin Configuration

Figure 1. Pin Diagram

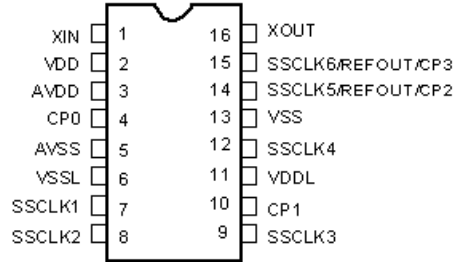

General Description

The CY25200 is a Spread Spectrum Clock Generator (SSCG) IC used to reduce Electro Magnetic Interference (EMI) found in today's high speed digital electronic systems.

The device uses a Cypress proprietary Phase-Locked Loop (PLL) and Spread Spectrum Clock (SSC) technology to synthesize and modulate the frequency of the input clock. By frequency modulating the clock, the measured EMI at the fundamental and harmonic frequencies are reduced. This reduction in radiated energy significantly reduces the cost of complying with regulatory agency requirements (EMC) and improves time to market, without degrading system performance.

The CY25200 uses a factory and field-programmable configuration memory array to synthesize output frequency,

spread %, crystal load capacitor, clock control pins, PD#, and OE options.

The spread % is factory and field-programmed to either center spread or down spread with various spread percentages. The range for center spread is from $\pm 0.25\%$ to $\pm 2.50\%$. The range for down spread is from -0.5% to -5.0% . Contact the factory for smaller or larger spread % amounts, if required.

The input to the CY25200 is either a crystal or a clock signal. The input frequency range for crystals is 8 to 30 MHz and for clock signals is 8 to 166 MHz.

The CY25200 has six clock outputs, SSCLK1 to SSCLK6. The frequency modulated SSCLK outputs are programmed from 3 to 200 MHz.

The CY25200 products are available in a 16-pin TSSOP package with a commercial operating temperature range of 0 to 70 °C.

Table 1. Pin Summary

Name	Pin Number	Description
XIN	1	Crystal input or Reference Clock input
XOUT	16	Crystal output. Leave this pin floating if external clock is used
VDD	2	3.3 V power supply for digital logic and SSCLK5 and 6 clock outputs
AVDD	3	3.3 V analog-PLL power supply
VSS	13	Ground
AVSS	5	Analog ground
VDDL	11	2.5 V or 3.3 V power supply for SSCLK1/2/3/4 clock outputs
VSSL	6	VDDL power supply ground
SSCLK1	7	Programmable spread spectrum clock output at VDDL level (2.5 V or 3.3 V)
SSCLK2	8	Programmable spread spectrum clock output at VDDL level (2.5 V or 3.3 V)
SSCLK3	9	Programmable spread spectrum clock output at VDDL level (2.5 V or 3.3 V)
SSCLK4	12	Programmable spread spectrum clock output at VDDL level (2.5 V or 3.3 V)
SSCLK5/REFOUT/CP2	14	Programmable spread spectrum clock or buffered reference output at VDD level (3.3 V) or control pin, CP2
SSCLK6/REFOUT/CP3	15	Programmable spread spectrum clock or buffered reference output at VDD level (3.3 V) or control pin, CP3
CP0 ^[1]	4	Control pin 0
CP1 ^[1]	10	Control pin 1

Note

1. Pins are programmed to be any of the following control signals: OE: Output Enable, OE = 1, all the SSCLK outputs are enabled; PD#: Power down, PD# = 0, all the SSCLK outputs are three-stated and the part enters a low power state; SSON: Spread Spectrum Control (SSON = 0, No Spread and SSON = 1, Spread Signal), CLKSEL: SSCLK Output Frequency Select. See [Control Pins \(CP0, CP1, CP2 and CP3\)](#) for control pins programming options.

Table 2. Fixed Function Pins

Pin Function	Output Clock Frequency	Input Frequency	C _{XIN} and C _{XOUT}	Spread Percent	Modulation Frequency
Pin Name	SSCLK[1:6]	XIN and XOUT	XIN and XOUT	SSCLK[1:6]	SSCLK[1:6]
Pin#	7, 8, 9, 12, 14, 15	1 and 16	1 and 16	7, 8, 9, 12, 14, 15	7, 8, 9, 12, 14, 15
Units	MHz	MHz	pF	% and Center- or Down-spread	kHz
Program Value CLKSEL = 0	USER SPECIFIED	USER SPECIFIED	USER SPECIFIED	USER SPECIFIED	USER SPECIFIED
Program Value CLKSEL = 1	USER SPECIFIED				

Table 3. Multi-Function Pins

Pin Function	Output Clock/REFOUT/OE/SSON/CLKSEL		OE/PD#/SSON/CLKSEL	
Pin Name	SSCLK5/REFOUT/CP2	SSCLK6/REFOUT/CP3	CP0	CP1
Pin#	14	15	4	10
Units	Function	Function	Function	Function
	USER SPECIFIED	USER SPECIFIED	USER SPECIFIED	USER SPECIFIED

Programming Description

Field-Programmable CY25200

The CY25200 is programmed at the package level, and must be programmed prior to installation on a circuit board. Field programmable devices are denoted by an “F” in the ordering code, and are blank when shipped. The CY25200 is Flash technology based, which allows it to be reprogrammed up to 100 times. This allows for fast and easy design changes and product updates, and eliminates issues with old and out of date inventory.

Samples and small prototype quantities are programmed on the CY3672 programmer with the CY3695 socket adapter.

CyberClocks™ Online Software

CyberClocks™ Online Software is a web based software application that allows the user to custom configure the CY25200. All the parameters in Table 2 and Table 3 are entered as variables into the software. CyberClocks Online outputs an

industry standard JEDEC file used for programming the CY25200. CyberClocks Online is available at www.cyberclocksonline.com website.

Factory-Programmed CY25200

Factory programming by Cypress is available for high volume orders. All requests must be submitted to the local Cypress Field Application Engineer (FAE) or sales representative. After the request is processed, you will receive a new part number, samples, and data sheet with the programmed values. This part number is used for additional sample requests and production orders.

Product Functions

Control Pins (CP0, CP1, CP2 and CP3)

Four control signals are available through programming of pins 4, 10, 14, and 15.

CP0 (pin 4) and CP1 (pin10) are specifically designed to function as control pins. However, pins 14 (SSCLK5/REFOUT/CP2) and 15 (SSCLK6/REFOUT/CP3) are multi-functional and can be programmed to be either a control signal or an output clock (SSCLK or REFOUT). All of the control pins, CP0, CP1, CP2, and CP3 are programmable to one of the following functions:

- OE (Output Enable): if OE = 1, all SSCLK and REFOUT outputs are enabled.
- SSON (Spread spectrum control): if SSON = 1, spread is on; if SSON = 0, spread is off.
- CLKSEL (Clock select): frequency select for all SSCLK outputs.
- PD# (Power Down; active low): if PD# = 0, all the outputs are three-stated and the part enters a low power state.

Note that the PD# function is available only on CP0 or CP1; it is not available on CP2 or CP3.

Example

Here is an example with three control pins:

- CLKIN = 33 MHz
- SSCLK1/2/3/4 = 100 MHz with ±1% spread
- SSCLK 5 = REFOUT(33 MHz)
- CP0 (pin 4) = PD#
- CP1 (pin 10) = OE
- CP3 (pin 15) = SSON

The pinout for the above example is shown in [Figure 2](#).

Figure 2. Example Pin Diagram

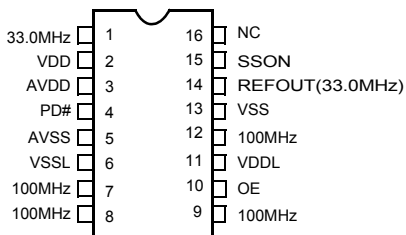

CLKSEL

The CLKSEL control pin enables you to select between two different SSCLK output frequencies. These must be related frequencies that are derived off of a common PLL frequency. Specifically, CLKSEL does not change the PLL frequency. It only changes the output divider. For instance, 33.333 MHz and 66.666 MHz are both derived from a PLL frequency of 400 MHz, by dividing it down by 12 and 6 respectively. [Table 4 on page 6](#) shows an example of how this is implemented. The PLL frequency range is 100 to 400 MHz. The two output dividers in the CY25200 can be any integer between 2 and 130, providing two different but related frequencies as explained above.

[Table 4 on page 6](#) and [Figure 3 on page 6](#) show an example configuration using the frequencies just described. In this example, the configurable pins SSCLK5 (pin 14) and SSCLK6 (pin 15) are used as output clocks.

Input Frequency (XIN, Pin 1 and XOUT, Pin 16)

The input to the CY25200 is a crystal or a clock. The input frequency range for crystals is 8 to 30 MHz, and for clock signal is 8 to 166 MHz.

C_{XIN} and C_{XOUT} (Pin 1 and Pin 16)

The CY25200 has internal load capacitors at pin 1 (C_{XIN}) and pin 16 (C_{XOUT}). C_{XIN} always equals C_{XOUT}, and they are programmable from 12 pF to 60 pF, in 0.5 pF increments. This feature eliminates the need for external crystal load capacitors.

The following formula is used to calculate the value of C_{XIN} and C_{XOUT} for matching the crystal load (C_L):

$$C_{XIN} = C_{XOUT} = 2C_L - C_P$$

Where C_L is the crystal load capacitor as specified by the crystal manufacturer and C_P is the parasitic PCB capacitance on each node of the crystal.

For example, if a crystal with C_L of 16 pF is used, and C_P is 2 pF, C_{XIN} and C_{XOUT} is calculated as:

$$C_{XIN} = C_{XOUT} = (2 \times 16) - 2 = 30 \text{ pF.}$$

If using a driven reference clock, set C_{XIN} and C_{XOUT} to the minimum value 12 pF, connect the reference to XIN/CLKIN, and leave XOUT unconnected.

Output Frequency (SSCLK1 through SSCLK6 Outputs)

All the SSCLK outputs are produced by synthesizing the input reference frequency using a PLL and modulating the VCO frequency. SSCLK[1:4] are fixed function output clocks (SSCLK). SSCLK5 and SSCLK6 are also programmable to function the same as SSCLK[1:4], or as buffered copies of the input reference (REFOUT), or as control pin as discussed in [Control Pins \(CP0, CP1, CP2 and CP3\)](#). To use the 2.5 V output drive option on SSCLK[1:4], VDDL must be connected to a 2.5 V power supply (SSCLK[1:4] outputs are powered by VDDL). When using the 2.5 V output drive option, the maximum output frequency on SSCLK[1:4] is 166 MHz.

Spread Percentage (SSCLK1 to SSCLK6 Outputs)

The SSCLK frequency is programmed to a percentage value from $\pm 0.25\%$ to $\pm 2.5\%$ for center spread and from -0.5% to -5.0% down spread. The granularity is 0.25%.

Modulation Frequency

The default modulation frequency is 31.5 kHz. Other modulation frequencies available via the configuration software are 30.1 kHz and 32.9 kHz.

Table 4. Using Clock Select, CLKSEL Control Pin

Input Frequency (MHz)	CLKSEL (Pin 4)	SSCLK1 (Pin 7)	SSCLK2 (Pin 8)	SSCLK3 (Pin 9)	SSCLK4 (Pin 12)	REFOUT (Pin 14)	REFOUT (Pin 15)
14.318	CLKSEL = 0	33.33	33.33	33.33	33.33	14.318	14.318
	CLKSEL = 1	66.66	66.66	66.66	66.66	14.318	14.318

Figure 3. Using Clock Select, CLKSEL Control Pin Configuration Pinout

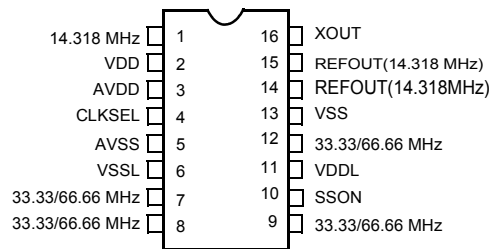

Switching Waveforms

Figure 4. Duty Cycle Timing ($DC = t_{1A}/t_{1B}$)

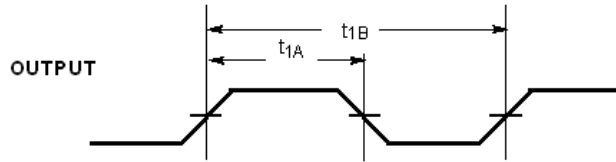
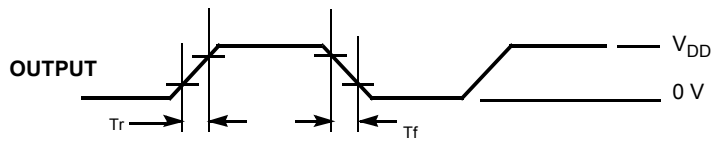

Figure 5. Output Rise and Fall Time (SSCLK and REFCLK)



Output Rise time ($T_r = (0.6 \times V_{DD})/SR1$ (or $SR3$)
 Output Fall time ($T_f = (0.6 \times V_{DD})/SR2$ (or $SR4$)
 Refer to AC Electrical Characteristics table for SR (Slew Rate) values.

Figure 6. Power Down and Power Up Timing

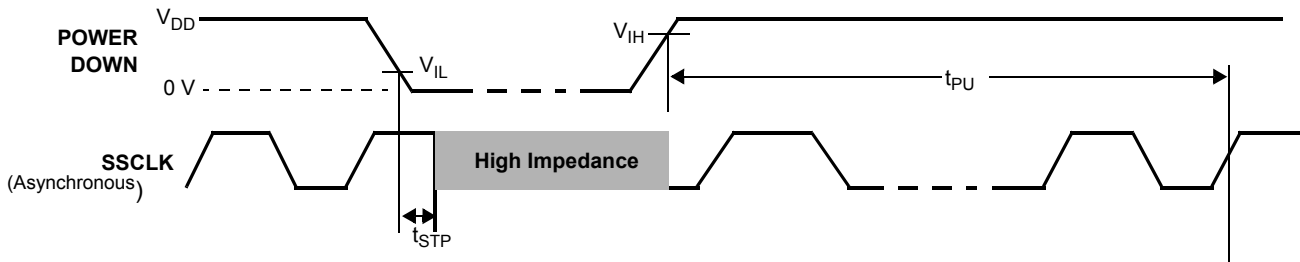
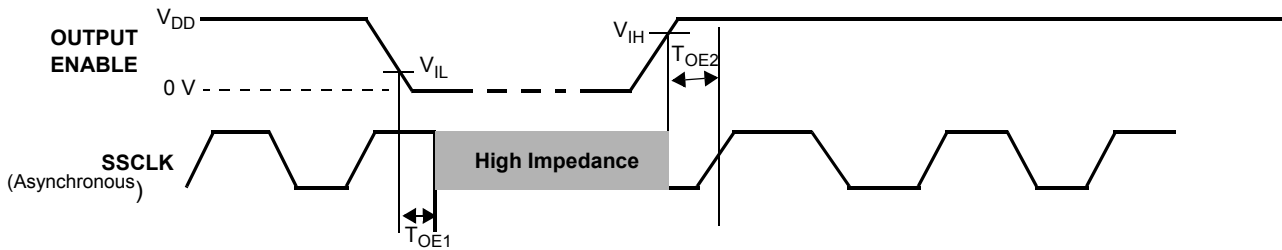
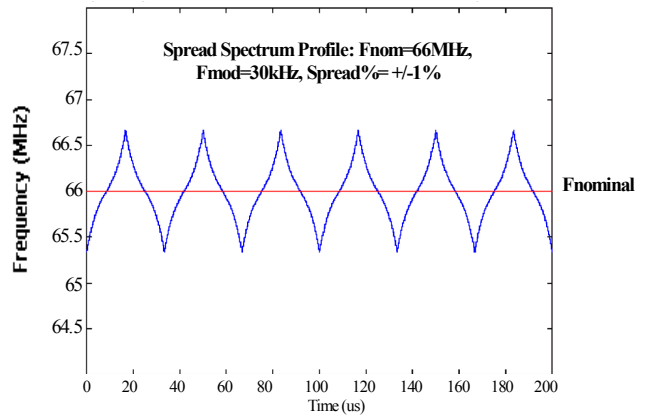
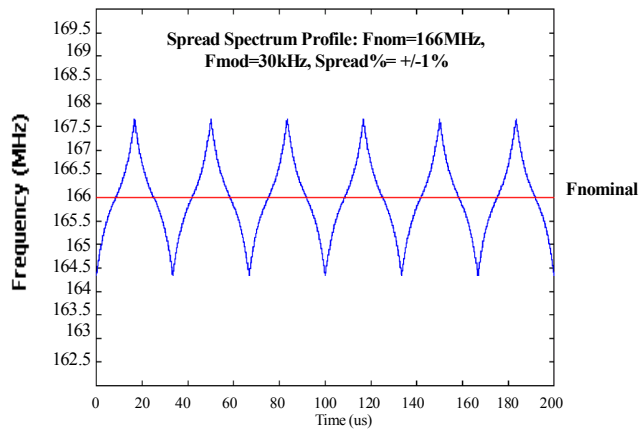
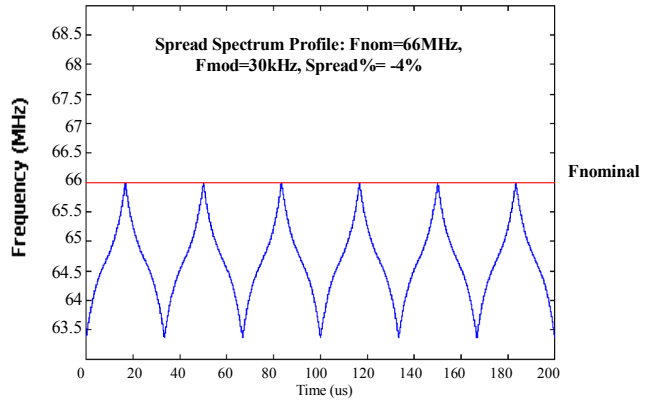
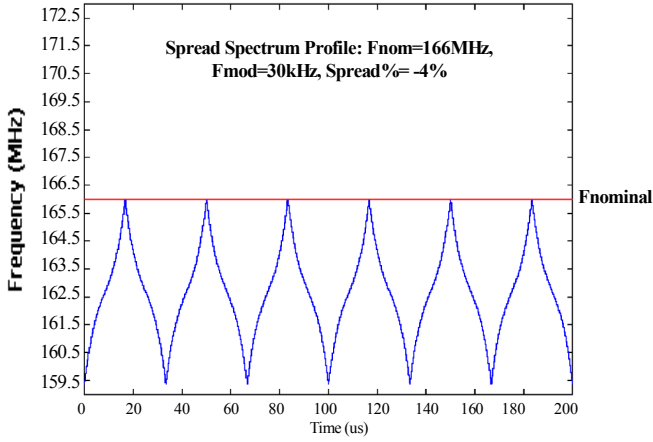

Figure 7. Output Enable and Disable Timing



Informational Graphs

The informational graphs are meant to convey the typical performance levels. No performance specifications is implied or guaranteed.



Absolute Maximum Rating

Supply Voltage (VDD).....	-0.5 to +7.0 V	Data Retention at Tj = 125 °C	> 10 years
DC Input Voltage	-0.5 V to V _{DD} + 0.5 V	Package Power Dissipation.....	350 mW
Storage Temperature (non-condensing) ...	-55 °C to +125 °C	Static Discharge Voltage.....	≥ 2000 V
Junction Temperature	-40 °C to +125 °C	(per MIL-STD-883, Method 3015)	

Recommended Crystal Specifications

Parameter	Description	Comments	Min	Typ	Max	Unit
F _{NOM}	Nominal Crystal Frequency	Parallel resonance, fundamental mode, AT cut	8	–	30	MHz
C _L NOM	Nominal Load Capacitance	Internal load caps	6	–	30	pF
R ₁	Equivalent Series Resistance (ESR)	Fundamental mode	–	–	25	Ω
R ₃ /R ₁	Ratio of Third Overtone Mode ESR to Fundamental Mode ESR	Ratio used because typical R ₁ values are much less than the maximum specification	3	–	–	Ω
DL	Crystal Drive Level	No external series resistor assumed	–	0.5	2	mW

Recommended Operating Conditions

Parameter	Description	Min	Typ	Max	Unit
V _{DD}	Operating Voltage	3.135	3.3	3.465	V
V _{DDLHI}	Operating Voltage	3.135	3.3	3.465	V
V _{DDLLO}	Operating Voltage	2.375	2.5	2.625	V
T _{AC}	Ambient Commercial Temp	0	–	70	°C
C _{LOAD}	Maximum Load Capacitance V _{DD} /V _{DDL} = 3.3 V	–	–	15	pF
C _{LOAD}	Maximum Load Capacitance V _{DDL} = 2.5 V	–	–	15	pF
F _{SSCLK-HighVoltage}	SSCLK1/2/3/4/5/6 when V _{DD} = A _{VDD} = V _{DDL} = 3.3 V	3	–	200	MHz
F _{SSCLK-LowVoltage}	SSCLK1/2/3/4 when V _{DD} = A _{VDD} = 3.3 V and V _{DDL} = 2.5 V	3	–	166	MHz
R _{EFOUT}	REFOUT when V _{DD} = A _{VDD} = 3.3 V and V _{DDL} = 3.3 V or 2.5 V	8	–	166	MHz
f _{REF1}	Clock Input	8	–	166	MHz
f _{REF2}	Crystal Input	8	–	30	MHz
t _{PU}	Power up time for all V _{DD} s to reach minimum specified voltage (power ramps must be monotonic)	0.05	–	500	ms

DC Electrical Specifications

Parameter ^[2]	Name	Description	Min	Typ	Max	Unit
I _{OH3.3}	Output High Current	V _{OH} = V _{DD} – 0.5 V, V _{DD} /V _{DDL} = 3.3 V	12	24	–	mA
I _{OL3.3}	Output Low Current	V _{OL} = 0.5 V, V _{DD} /V _{DDL} = 3.3 V	12	24	–	mA
I _{OH2.5}	Output High Current	V _{OH} = V _{DDL} – 0.5 V, V _{DDL} = 2.5 V	8	16	–	mA
I _{OL2.5}	Output Low Current	V _{OL} = 0.5 V, V _{DDL} = 2.5 V	8	16	–	mA
V _{IH}	Input High Voltage	CMOS levels, 70% of V _{DD}	0.7	–	1.0	V _{DD}
V _{IL}	Input Low Voltage	CMOS levels, 30% of V _{DD}	0	–	0.3	V _{DD}
I _{VDD} ^[3]	Supply Current	A _{VDD} /V _{DD} Current	–	–	33	mA
I _{VDDL2.5} ^[3]	Supply Current	V _{DDL} Current (V _{DDL} = 2.625 V)	–	–	20	mA
I _{VDDL3.3} ^[3]	Supply Current	V _{DDL} Current (V _{DDL} = 3.465 V)	–	–	26	mA
I _{DDS}	Power Down Current	V _{DD} = V _{DDL} = A _{VDD} = 3.465 V	–	–	50	μA
I _{OHZ} I _{OLZ}	Output Leakage	V _{DD} = V _{DDL} = A _{VDD} = 3.465 V	–	–	10	μA

Notes

- Not 100% tested, guaranteed by design.
- I_{VDD} currents specified for SSCLK1/2/3/4/5/6 = 33.33 MHz with CLKIN = 14.318 MHz and 15 pF on all the output clocks.

AC Electrical Specifications

Parameter	Description	Condition	Min	Typ	Max	Unit
DC	Output Duty Cycle	SSCLK, Measured at $V_{DD}/2$	45	50	55	%
	Output Duty Cycle	REFCLK, Measured at $V_{DD}/2$ Duty Cycle of CLKIN = 50%.	40	50	60	%
SR1	Rising/Falling Edge Slew Rate	SSCLK1/2/3/4 < 100 MHz, $V_{DD} = V_{DDL} = 3.3\text{ V}$	0.6	–	2.0	V/ns
SR2	Rising/Falling Edge Slew Rate	SSCLK1/2/3/4 \geq 100 MHz, $V_{DD} = V_{DDL} = 3.3\text{ V}$	0.8	–	3.5	V/ns
SR3	Rising/Falling Edge Slew Rate	SSCLK1/2/3/4 < 100 MHz, $V_{DD} = V_{DDL} = 2.5\text{ V}$	0.5	–	2.2	V/ns
SR4	Rising/Falling Edge Slew Rate	SSCLK1/2/3/4 \geq 100 MHz, $V_{DD} = V_{DDL} = 2.5\text{ V}$	0.6	–	3.0	V/ns
SR5	Rising/Falling Edge Slew Rate	SSCLK5/6 < 100 MHz, $V_{DD} = V_{DDL} = 3.3\text{ V}$	0.6	–	1.9	V/ns
SR6	Rising/Falling Edge Slew Rate	SSCLK5/6 \geq 100 MHz, $V_{DD} = V_{DDL} = 3.3\text{ V}$	1.0	–	2.9	V/ns
T_{CCJ1}	Cycle-to-Cycle Jitter SSCLK1/2/3/4	CLKIN = SSCLK1/2/3/4 = 166 MHz, $\pm 2\%$ spread and SSCLK5/6 = REFOUT, $V_{DD} = V_{DDL} = 3.3\text{ V}$	–	–	110	ps
		CLKIN = SSCLK1/2/3/4 = 66.66 MHz, $\pm 2\%$ spread and SSCLK5/6 = REFOUT, $V_{DD} = V_{DDL} = 3.3\text{ V}$	–	–	170	ps
		CLKIN = SSCLK1/2/3/4 = 33.33 MHz, $\pm 2\%$ spread and SSCLK5/6 = REFOUT, $V_{DD} = V_{DDL} = 3.3\text{ V}$	–	–	140	ps
		CLKIN = SSCLK1/2/3/4 = 14.318 MHz, $\pm 2\%$ spread and SSCLK5/6 = REFOUT, $V_{DD} = V_{DDL} = 3.3\text{ V}$	–	–	290	ps
T_{CCJ2}	Cycle-to-Cycle Jitter SSCLK5/6=REFOUT	CLKIN = SSCLK1/2/3/4 = 166 MHz, $\pm 2\%$ spread and SSCLK5/6 = REFOUT, $V_{DD} = V_{DDL} = 3.3\text{ V}$	–	–	100	ps
		CLKIN = SSCLK1/2/3/4 = 66.66 MHz, $\pm 2\%$ spread and SSCLK5/6 = REFOUT, $V_{DD} = V_{DDL} = 3.3\text{ V}$	–	–	120	ps
		CLKIN = SSCLK1/2/3/4 = 33.33 MHz, $\pm 2\%$ spread and SSCLK5/6 = REFOUT, $V_{DD} = V_{DDL} = 3.3\text{ V}$	–	–	180	ps
		CLKIN = SSCLK1/2/3/4 = 14.318 MHz, $\pm 2\%$ spread and SSCLK5/6 = REFOUT, $V_{DD} = V_{DDL} = 3.3\text{ V}$	–	–	180	ps
T_{CCJ3}	Cycle-to-Cycle Jitter SSCLK1/2/3/4	CLKIN = SSCLK1/2/3/4 = 166 MHz, $\pm 2\%$ spread and SSCLK5/6 = REFOUT, $V_{DD} = 3.3\text{ V}$, $V_{DDL} = 2.5\text{ V}$	–	–	110	ps
		CLKIN = SSCLK1/2/3/4 = 66.66 MHz, $\pm 2\%$ spread and SSCLK5/6 = REFOUT, $V_{DD} = 3.3\text{ V}$, $V_{DDL} = 2.5\text{ V}$	–	–	170	ps
		CLKIN = SSCLK1/2/3/4 = 33.33 MHz, $\pm 2\%$ spread and SSCLK5/6 = REFOUT, $V_{DD} = 3.3\text{ V}$, $V_{DDL} = 2.5\text{ V}$	–	–	190	ps
		CLKIN = SSCLK1/2/3/4 = 14.318 MHz, $\pm 2\%$ spread and SSCLK5/6 = REFOUT, $V_{DD} = 3.3\text{ V}$, $V_{DDL} = 2.5\text{ V}$	–	–	330	ps
T_{STP}	Power Down Time	Time from falling edge on PD# to stopped outputs (Asynchronous)	–	150	300	ns
T_{OE1}	Output Disable Time	Time from falling edge on OE to stopped outputs (Asynchronous)	–	150	300	ns
T_{OE2}	Output Enable Time	Time from rising edge on OE to outputs at a valid frequency (Asynchronous)	–	150	300	ns
F_{MOD}	Spread Spectrum Modulation Frequency	SSCLK1/2/3/4/5/6	30.0	31.5	33.0	kHz
T_{PU1}	Power Up Time, Crystal is used	Time from rising edge on PD# to outputs at valid frequency (Asynchronous)	–	3	5	ms
T_{PU2}	Power Up Time, Reference clock is used	Time from rising edge on PD# to outputs at valid frequency (Asynchronous)	–	2	3	ms
$T_{SKEW}^{[4]}$	Clock Skew	Output to output skew between related clock outputs. Measured at $V_{DD}/2$.	–	–	250	ps

Note

4. Skew and phase alignment is guaranteed within all SSCLK outputs and within both REFOUT outputs. All SSCLK outputs are related, and all REOUT outputs are related, but SSCLK and REFOUT outputs are not related to each other.

Ordering Information

Ordering Code	Package Type	Programming	Operating Temperature Range
CY25200KFZXC	16-Pin TSSOP (Pb-free)	Field	Commercial, 0 to 70 °C
CY25200KFZXCT	16-Pin TSSOP – Tape and Reel (Pb-free)	Field	Commercial, 0 to 70 °C
Programmer			
CY3672-USB	Programmer for Field Programmable Devices	N/A	N/A
CY3695	CY22050/CY22150/CY25200 Socket Adapter for CY3672-USB	N/A	N/A

Some product offerings are factory programmed customer specific devices with customized part numbers. The Possible Configurations table shows the available device types, but not complete part numbers. Contact your local Cypress FAE or Sales Representative for more information.

Possible Configurations

Ordering Code ^[5]	Package Type	Programming	Operating Temperature Range
CY25200K-ZXCxxxw	16-Pin TSSOP (Pb-free)	Factory	Commercial, 0 to 70 °C
CY25200K-ZXCxxxwT	16-Pin TSSOP – Tape and Reel (Pb-free)	Factory	Commercial, 0 to 70 °C

Ordering Code Definitions

CY 25200K (F) (Z) X (C) (-xxx) (T)

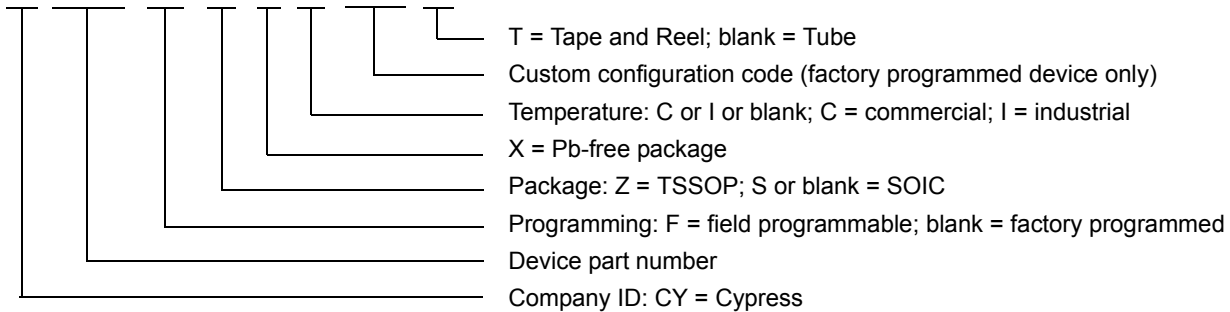

Table 5. 16-pin TSSOP Package Characteristics

Parameter	Name	Value	Unit
θ_{JA}	theta JA	115	°C/W

Note

5. "xxx" denotes a specific device configuration, and is referred to as the "dash number". "w" denotes the configuration revision.

Package Drawing and Dimensions

Figure 8. 16-pin TSSOP 4.40 mm Body ZZ16

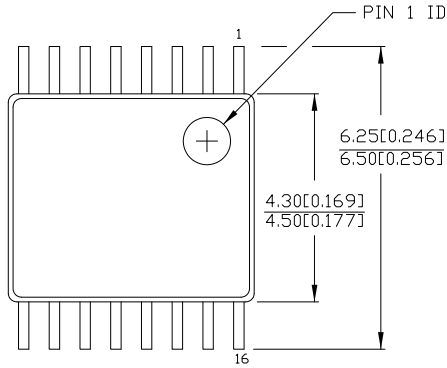

DIMENSIONS IN MM [INCHES] MIN. MAX.
 REFERENCE JEDEC MO-153
 PACKAGE WEIGHT 0.05gms

PART #	
Z16.173	STANDARD PKG.
ZZ16.173	LEAD FREE PKG.

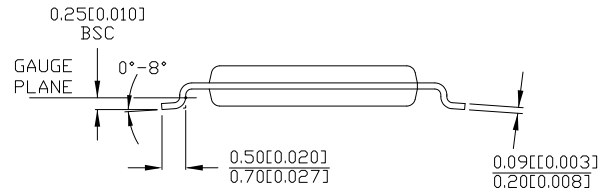
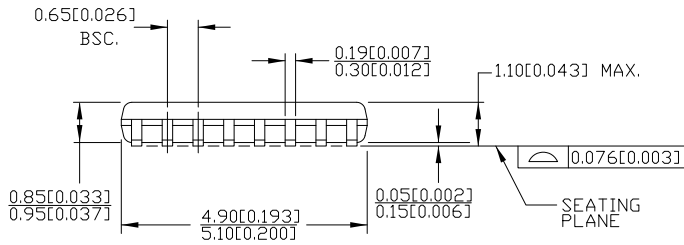

51-85091 *C

Acronyms

Acronym	Description
CMOS	complementary metal oxide semiconductor
EMC	electro magnetic compatibility
EMI	electro magnetic interference
FAE	field application engineer
OE	output enable
OSC	oscillator
PLL	phase locked loop
SSC	Spread Spectrum Clock
SSCG	Spread Spectrum Clock Generator
TSSOP	thin shrunk small outline package

Document Conventions

Units of Measure

Symbol	Unit of Measure
°C	degree Celsius
Ω	ohms
kΩ	kilo ohms
kHz	kilo Hertz
MHz	Mega Hertz
μA	micro Amperes
ms	milli seconds
mW	milli Watts
ns	nano seconds
%	percent
pF	pico Farad
ps	pico seconds
V	Volts

Document History Page

Document Title: CY25200 Programmable Spread Spectrum Clock Generator for EMI Reduction Document Number: 38-07633				
REV.	ECN NO.	Orig. of Change	Submission Date	Description of Change
**	204243	RGL	See ECN	New data sheet
*A	220043	RGL	See ECN	Minor Change: Corrected letter assignment in the ordering info for Pb free.
*B	267832	RGL	See ECN	Added Field Programmable Devices and Functionality
*C	291094	RGL	See ECN	Added t _{SKEW} spec. and footnote
*D	1821908	DPF/AESA	See ECN	Corrected FSSCLK-Low Voltage specification on page 7 for SSCLK5/6 to SSCLK1/2/3/4, as SSCLK5/6 output does not operate at low voltage. Deleted Tccj4 on page 8 for the same reason as above
*E	2442066	KVM/AESA	See ECN	Updated template. Added Note "Not recommended for new designs." Added part number CY25200KZXC_XXXW, CY25200KZXC_XXXWT, CY25200KFZXC in ordering information table. Changed package name to ZZ16.
*F	2758387	KVM/AESA	09/01/2009	Extensive text edits Replaced Benefits column on page 1 with Description Revised Table 2 and Table 3 for clarity Revised the Modulation Frequency paragraph to align with actual software options and to delete mention of custom frequencies Corrected 3.3V I _{OL} and I _{OH} values, Filled in missing units in AC Electrical table Revised T _{SKEW} footnote for clarity Removed specific PD# and OE pin nos. from parameters T _{STP} , T _{OE1} and T _{OE2} Standardized timing parameter names to upper case Corrected part numbers in Ordering Information Table Removed part number CY25200FZXCT Added part number CY25200KFZXCT Replaced CY3672 and CY3672-PRG with CY3672-USB
*G	2897246	KVM	03/22/10	Removed inactive parts from Ordering Information table. Added note regarding possible configurations in Ordering Information section. Removed Note 6. Added Possible Configurations table. Updated Package Drawing and Dimensions .
*H	3103982	BASH	07/12/2010	Added Ordering Code Definitions . Updated Package Drawing and Dimensions . Added Acronyms and Units of Measure . Minor edits and updated in new template.

Sales, Solutions, and Legal Information

Worldwide Sales and Design Support

Cypress maintains a worldwide network of offices, solution centers, manufacturer's representatives, and distributors. To find the office closest to you, visit us at www.cypress.com/sales.

Products

Automotive	cypress.com/go/automotive
Clocks & Buffers	cypress.com/go/clocks
Interface	cypress.com/go/interface
Lighting & Power Control	cypress.com/go/powerpsoc cypress.com/go/plc
Memory	cypress.com/go/memory
Optical & Image Sensing	cypress.com/go/image
PSoC	cypress.com/go/psoc
Touch Sensing	cypress.com/go/touch
USB Controllers	cypress.com/go/USB
Wireless/RF	cypress.com/go/wireless

PSoC Solutions

psoc.cypress.com/solutions
PSoC 1 | PSoC 3 | PSoC 5

© Cypress Semiconductor Corporation, 2004-2010. The information contained herein is subject to change without notice. Cypress Semiconductor Corporation assumes no responsibility for the use of any circuitry other than circuitry embodied in a Cypress product. Nor does it convey or imply any license under patent or other rights. Cypress products are not warranted nor intended to be used for medical, life support, life saving, critical control or safety applications, unless pursuant to an express written agreement with Cypress. Furthermore, Cypress does not authorize its products for use as critical components in life-support systems where a malfunction or failure may reasonably be expected to result in significant injury to the user. The inclusion of Cypress products in life-support systems application implies that the manufacturer assumes all risk of such use and in doing so indemnifies Cypress against all charges.

Any Source Code (software and/or firmware) is owned by Cypress Semiconductor Corporation (Cypress) and is protected by and subject to worldwide patent protection (United States and foreign), United States copyright laws and international treaty provisions. Cypress hereby grants to licensee a personal, non-exclusive, non-transferable license to copy, use, modify, create derivative works of, and compile the Cypress Source Code and derivative works for the sole purpose of creating custom software and or firmware in support of licensee product to be used only in conjunction with a Cypress integrated circuit as specified in the applicable agreement. Any reproduction, modification, translation, compilation, or representation of this Source Code except as specified above is prohibited without the express written permission of Cypress.

Disclaimer: CYPRESS MAKES NO WARRANTY OF ANY KIND, EXPRESS OR IMPLIED, WITH REGARD TO THIS MATERIAL, INCLUDING, BUT NOT LIMITED TO, THE IMPLIED WARRANTIES OF MERCHANTABILITY AND FITNESS FOR A PARTICULAR PURPOSE. Cypress reserves the right to make changes without further notice to the materials described herein. Cypress does not assume any liability arising out of the application or use of any product or circuit described herein. Cypress does not authorize its products for use as critical components in life-support systems where a malfunction or failure may reasonably be expected to result in significant injury to the user. The inclusion of Cypress' product in a life-support systems application implies that the manufacturer assumes all risk of such use and in doing so indemnifies Cypress against all charges.

Use may be limited by and subject to the applicable Cypress software license agreement.

Mouser Electronics

Authorized Distributor

Click to View Pricing, Inventory, Delivery & Lifecycle Information:

Cypress Semiconductor:

[CY25200KFZXCT](#) [CY25200K-ZXC002A](#) [CY25200K-ZXC002AT](#) [CY25200K-ZXC004A](#) [CY25200K-ZXC004AT](#)
[CY25200K-ZXC009B](#) [CY25200K-ZXC009BT](#) [CY25200KZXI-006T](#) [CY25200KZXI-007](#) [CY25200KZXI-007T](#)

Mouser Electronics

Authorized Distributor

Click to View Pricing, Inventory, Delivery & Lifecycle Information:

Cypress Semiconductor:

[CY25200K-ZXC002A](#) [CY25200K-ZXC002AT](#) [CY25200K-ZXC004A](#) [CY25200K-ZXC004AT](#) [CY25200K-ZXC009B](#)
[CY25200K-ZXC009BT](#) [CY25200KZXI-006T](#) [CY25200KZXI-007](#) [CY25200KZXI-007T](#)