

Features

- Standard or high torque option
- Long life carbon element
- Plain or knurled shaft option
- Brass bushing
- Metal shaft
- Audio or linear taper options
- Variety of resistance values



PDA24 - 24 mm Long Life Potentiometer

Electrical Characteristics

Taper.....Audio, linear
 Standard Resistance
from 10K to 1M ohms
 Standard Resistance Tolerance....±15 %

Environmental Characteristics

Operating Temperature
-10 °C to +70 °C
 Power Rating
 Linear Taper 0.5 watt
 Audio Taper 0.25 watt
 Maximum Operating Voltage
 Linear Taper500 V
 Audio Taper250 V
 Rotational Noise 100 mV max.

Mechanical Characteristics

Mechanical Angle 300 ° ±5 °
 Rotational Torque
 Standard..... 20 to 40 g-cm
 High..... 70 to 100 g-cm
 Stop Strength..... 7 kg-cm min.
 Rotational Life
200,000 shaft revolutions
 Soldering Condition
 Manual Soldering
 300 °C within 3 seconds
 Wave Soldering
 260 °C within 5 seconds
 HardwareOne flat washer and
 mounting nut supplied per
 potentiometer with bushing

Derating Curve

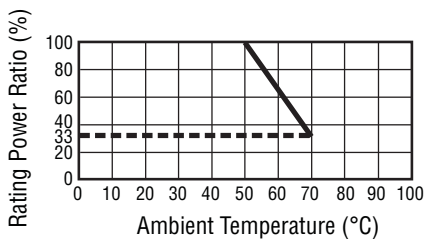

Circuit

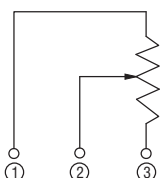

Product Dimensions

PDA241-xxx00, PDA241-xxx01

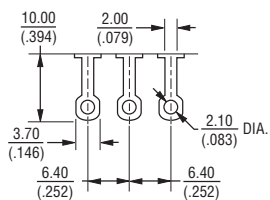
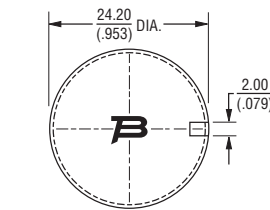
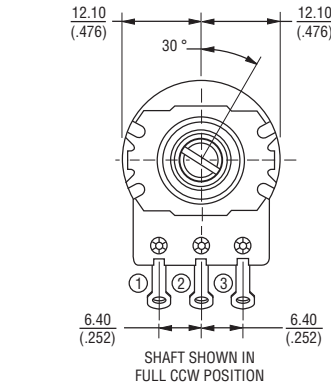
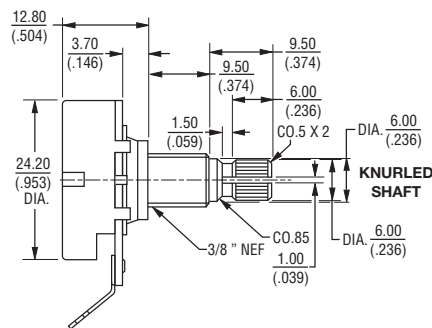

TOLERANCES:
 UNDER $\frac{10.0}{(.394)} = \pm 0.3 (\pm 0.012)$ $\frac{10.0 - 100}{(.394 - 3.937)} = \pm 0.5 (\pm 0.020)$

DIMENSIONS: $\frac{\text{MM}}{\text{(INCHES)}}$

PDA241-xxx02

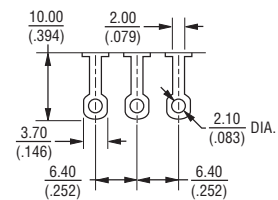
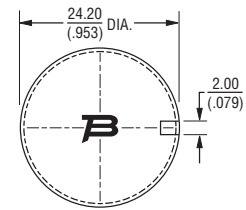
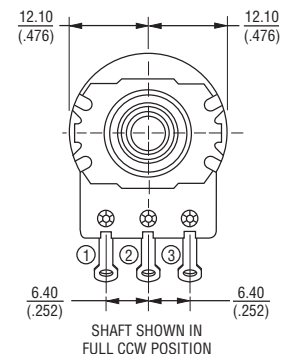
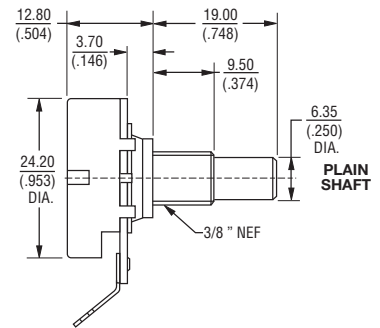

TOLERANCES:
 UNDER $\frac{10.0}{(.394)} = \pm 0.3 (\pm 0.012)$ $\frac{10.0 - 100}{(.394 - 3.937)} = \pm 0.5 (\pm 0.020)$

*RoHS Directive 2002/95/EC Jan. 27, 2003 including annex and RoHS Recast 2011/65/EU June 8, 2011. Specifications are subject to change without notice.

The device characteristics and parameters in this data sheet can and do vary in different applications and actual device performance may vary over time. Users should verify actual device performance in their specific applications.

Additional Features

- Long life
- Long solder lugs
- ±15 % resistance tolerance
- Anti-rotation pins
- RoHS compliant*

Applications

- Electric guitars
- Bass guitars
- Guitar amplifiers

PDA24 - 24 mm Long Life Potentiometer

BOURNS®

Tapers

A Series Tapers

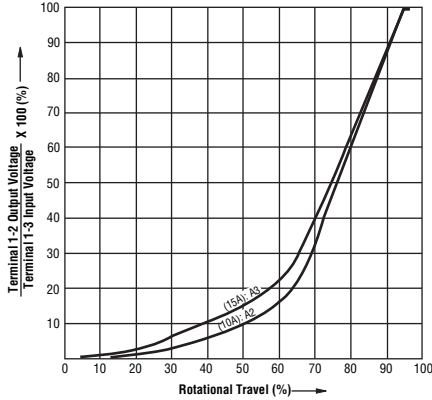

B0 Taper

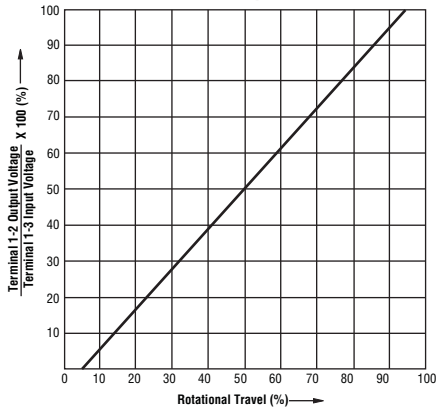

Standard Resistance Table

Resistance (Ohms)	Resistance Code
10,000	103
25,000	253
50,000	503
100,000	104
250,000	254
300,000	304
500,000	504
1,000,000	105

How To Order

PDA24 1 - SRT 01 - 504 A2

Model _____

Number of Units _____
1 = Single

Torque Option _____
Standard = SRT
High = HRT

Configuration _____
00 = Knurled Shaft (18 Teeth) / Long Solder Lugs
01 = Knurled Shaft (24 Teeth) / Long Solder Lugs
02 = Plain Shaft / Long Solder Lugs

Resistance Code (See Table) _____

Resistance Taper (See Taper Charts) _____

BOURNS®

Asia-Pacific: Tel: +886-2 2562-4117 • Fax: +886-2 2562-4116

EMEA: Tel: +36 88 520 390 • Fax: +36 88 520 211

The Americas: Tel: +1-951 781-5500 • Fax: +1-951 781-5700

www.bourns.com

REV. 04/14

Specifications are subject to change without notice.
The device characteristics and parameters in this data sheet can and do vary in different applications and actual device performance may vary over time.
Users should verify actual device performance in their specific applications.