

Series 48SS

12MM MINIATURE HALL-EFFECT SEALED

This rugged sealed pushbutton switch uses a Hall-Effect sensor to achieve extremely long life, up to 1,000,000 cycles momentary. This switch is suited for harsh environments where long life and reliability are needed.



ACTUAL SIZE

APPLICATIONS

- Communications
- Data entry
- Hand-held control modules
- Outdoor controls
- Mass transport controls
- Instrumentation

KEY FEATURES:

- 1,000,000 cycles momentary
- Momentary and maintained action
- Hall-Effect technology
- Choice of LED colors (or non-lighted versions)
- Panel sealed to IP67
- Variety of Button colors
- Square and round versions available
- Solder, PC terminals or Wireleads

ORDERING INFORMATION:

Switch Function	Switch Termination	Module Type	Bezel Type	LED Color †	Button Color	Mounting Type	Voltage Resistor
Momentary	Solder Tabs	48-3	RB - Round, Black	N - None	RD - Red	B - Bushing S - Snap-fit	If Blank* 05 - 5V forward
Maintained	Solder Tabs	48-4	SB - Square, Black	R - Red	GR - Green		
Momentary	PC	48-7	RC - Round, Chrome	G - Green	BK - Black		
Maintained	PC	48-6	SC - Square, Chrome	Y - Yellow	BL - Blue		
Momentary	Wire Leads	48-C		A - Amber	YL - Yellow		
Maintained	Wire Leads	48-D		B - Blue	OR - Orange		
				W - White	CR - Chrome		
				RB - Red / Blue	PK - Black with Standby Symbol		
				RG - Red / Green	WH - White		

† Lighted switches come with wires on LEDs to protect from solder heat.

* Current limiting resistor is required to limit LED forward current to 20 mA (not included).

STANDARDS / AGENCY / RATINGS:



PRODUCT DRAWINGS

FREE POSITION:
[7.6] .30 (LIGHTED)
[8.0] .32 (UNLIGHTED)
MAINTAINED POSITION:
[6.1] .24 (LIGHTED)
[6.5] .26 (UNLIGHTED)

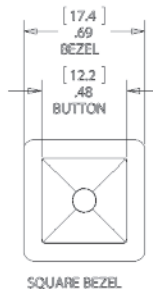
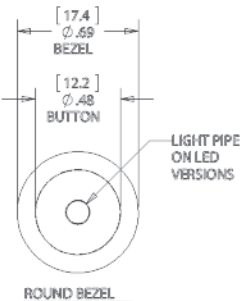
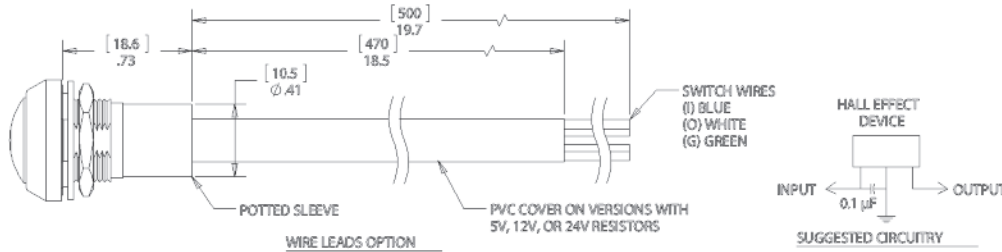
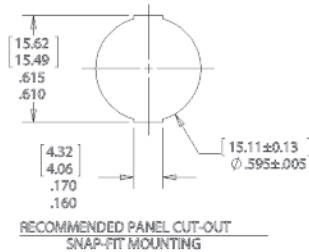
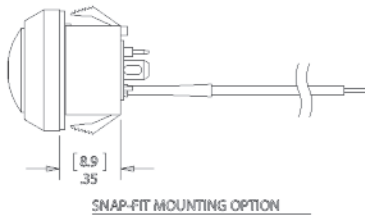
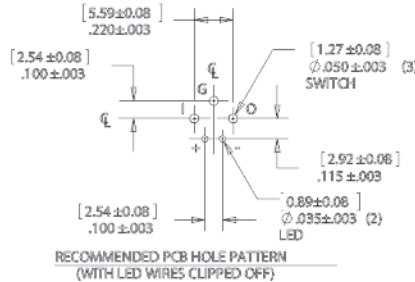
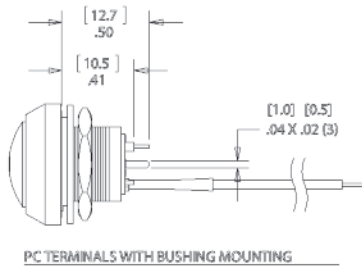
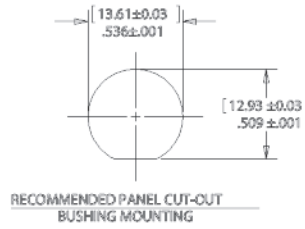
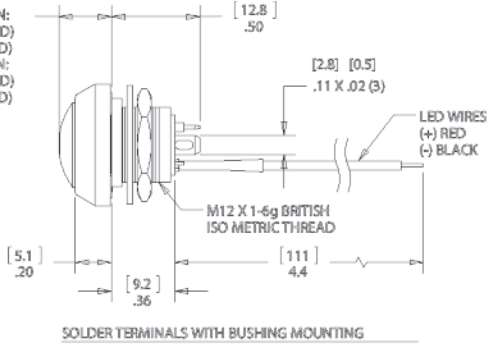

(MILLIMETERS)
INCHES

MECHANICAL CHARACTERISTICS

CIRCUIT:
SPST-NO-DB (FORM X)

BUTTON TRAVEL (NOM):
[2.3] .09

OPERATING FORCE (NOM):
[3N] 306g

PANEL THICKNESS:
BUSHING MOUNTING: [0.5-3.0]
.02-.12
SNAP-FIT MOUNTING: [1.3-3.0]
.05-.12

NUT TORQUE (MAX):
[11.5 kgf/cm] 10 lb/in

HARDWARE
BUSHING MOUNTING BULK
PACKAGED SEALING WASHER
AND HEX NUT ARE INCLUDED.

ENVIRONMENTAL SPECIFICATIONS

ACTUATOR INGRESS PROTECTION:
IP67

OPERATING TEMPERATURE:
[-40 C to +85 C] -40 F to +185 F

ELECTRICAL SPECIFICATIONS

SUPPLY VOLTAGE:
4.2V TO 24V, 26.5 MAX

SUPPLY CURRENT:
B < Brp, Vcc=12V:
3mA TYP to 8mA MAX
B > Bop, Vcc=12V:
4mA TYP to 8mA MAX

OUTPUT LOAD:
SINKING (I out MAX = 25mA)

REVERSE BATTERY VOLTAGE:
-30V MAX

REVERSE OUTPUT CURRENT:
-50mA MAX

SWITCH LIFE:
MOMENTARY: 1,000,000 CYCLES
MAINTAINED: 50,000 CYCLES

WIRE LEADS:
UL STYLE 1007
26 AWG, STRANDED