

9290 Series Pneumatic Cutters

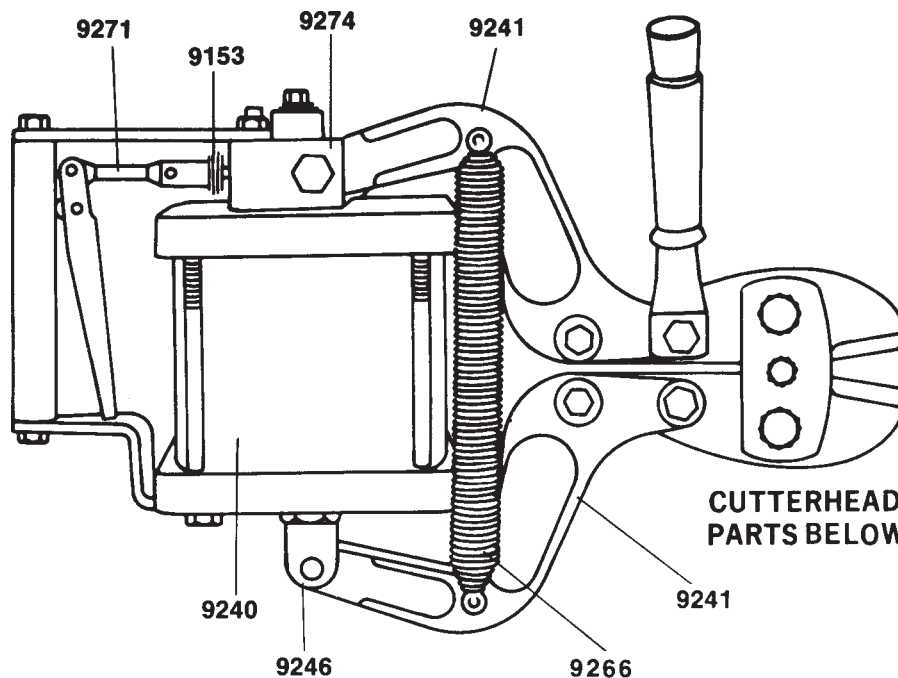

9232	Bumper Ring
9233	Seal, U-Cup
9234	Gasket
9236	Cap Screw
9237	Rod
9238	Piston
9239	Tube
9240	Cylinder Assy.
9241	Assembly, Arm & Pin
9246	Clevis
9249	Rush Rod
9251	Bracket, Lower
9252	Bracket, Upper
9254	Valve Body
9261	Cap Nut
9262	Bolt
9266	Spring, Extension
9268	Handle, Front
9269	Pin Pivot
9271	Trigger Assy.
9272	Cylinder & Grip Assy.
9274	Valve Body Assy.
1747	Pin, Cotter
2627G	Bolt
2666G	Nut
2666K	Nut
2727	Bolt
2775	Lockwasher
BU0180	Grip Rubber
SM0078	O'ring
330389	O'ring
330703	Plug, Hose Hole

Parts for 9290

Part No.	Description
9147 Grip
9150HK Cap, Valve
9153 Gasket, Valve Cap
9155 Pin, Plunger
9156 Gasket, Valve
9157 Spring, Compression
9158 Plunger, Air Valve
9159 Spring, Plunger
9163 Gasket, Cap Nut

9164	O'ring, Valve Plunger
9165	Screen, Cylinder
9170	Pin, Trigger Link
9173	Valve Plunger Assy.
9224	Lockwasher
9225	Screw, Clevis Adj.
9226	Nut, Clevis Adj. Screw
9227	Stud
9228	Nut, Flexiock
9229	Wiper Ring
9230	Front Head
9231	Rear Head

Repair Kit No. R9290

Consists of:

9153	9229
9156	9233
9163	9234
9164	SM0078
9165	330389

Cutterhead Parts For 9290C

Parts for 9290C

Item No.	Part No.	Description
.....	9213C Cutterhead Complete
.....	9212C Jaws, Pair
.....	0224 Cutterhead less Jaws
1	9210C Jaw, Right
2	9211C Jaw, Left
3	0221 Strap, Bottom
4	0220 Strap, Top
5	0256 Lockplate
6	0236 Bolt Left Thread
7	0257 Screw, Lockplate
8	0235 Bolt, Right Thread

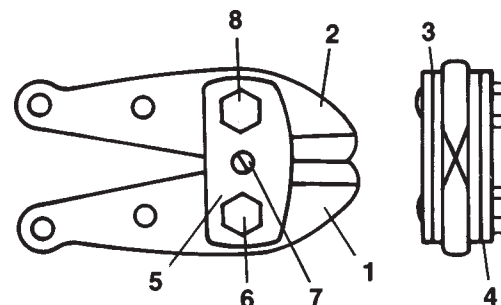

9290 Series Pneumatic Cutters

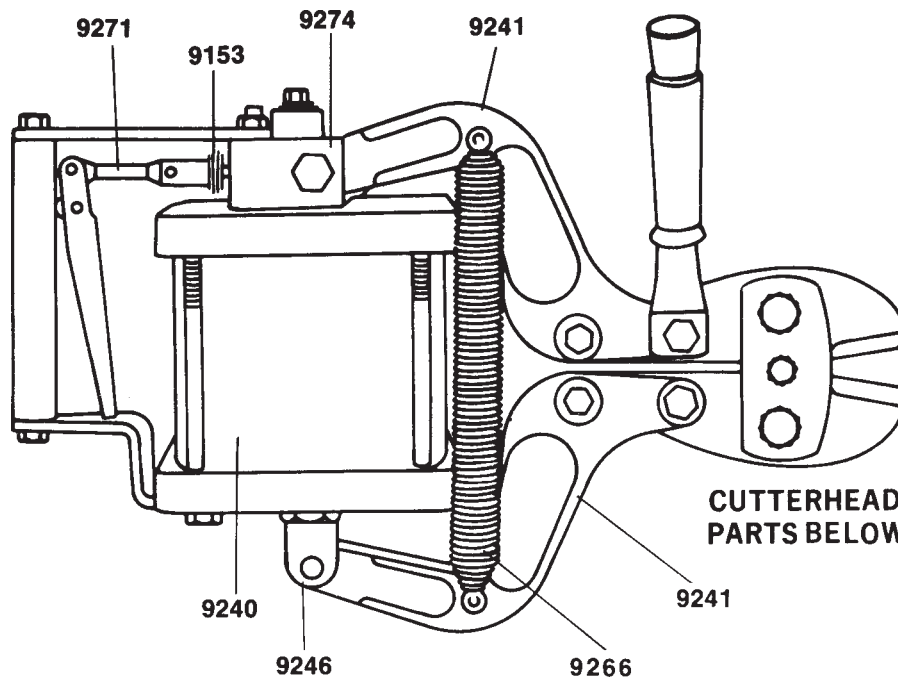

Parts for 9290

Part No.	Description
9147	Grip
9150HK	Cap, Valve
9153	Gasket, Valve Cap
9155	Pin, Plunger
9156	Gasket, Valve
9157	Spring, Compression
9158	Plunger, Air Valve
9159	Spring, Plunger
9163	Gasket, Cap Nut

9164	O'ring, Valve Plunger
9165	Screen, Cylinder
9170	Pin, Trigger Link
9173	Valve Plunger Assy.
9224	Lockwasher
9225	Screw, Clevis Adj.
9226	Nut, Clevis Adj. Screw
9227	Stud
9228	Nut, Flexiack
9229	Wiper Ring
9230	Front Head
9231	Rear Head

9232	Bumper Ring
9233	Seal, U-Cup
9234	Gasket
9236	Cap Screw
9237	Rod
9238	Piston
9239	Tube
9240	Cylinder Assy.
9241	Assembly, Arm & Pin
9246	Clevis
9249	Rush Rod
9251	Bracket, Lower
9252	Bracket, Upper
9254	Valve Body
9261	Cap Nut
9262	Bolt
9266	Spring, Extension
9268	Handle, Front
9269	Pin Pivot
9271	Trigger Assy.
9272	Cylinder & Grip Assy.
9274	Valve Body Assy.
1747	Pin, Cotter
2627G	Bolt
2666G	Nut
2666K	Nut
2727	Bolt
2775	Lockwasher
BU0180	Grip Rubber
SM0078	O'ring
330389	O'ring
330703	Plug, Hose Hole

Repair Kit No. R9290

Consists of:

9153	9229
9156	9233
9163	9234
9164	SM0078
9165	330389

Cutterhead Parts For 9290NE

Parts for 9290NE

Item No.	Part No.	Description
.....	9213NE	Cutterhead Complete
.....	9212NE	Jaws, Pair
.....	0224	Cutterhead less Jaws
1	9210NE	Jaw, Right
2	9211NE	Jaw, Left
3	0221	Strap, Bottom
4	0220	Strap, Top
5	0256	Lockplate
6	0236	Bolt Left Thread
7	0257	Screw, Lockplate
8	0235	Bolt, Right Thread

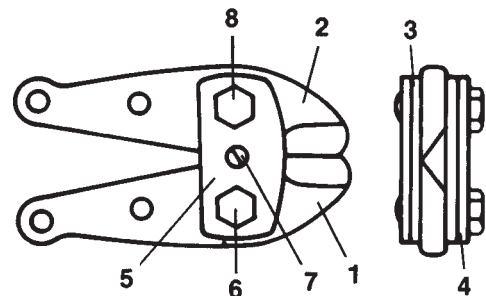

Tips to Easier, Safer Cutting

- a. When heavy cutting is involved, it is less strenuous to hold one handle of the tool on the ground using foot pressure. This permits the cutting force to be applied to the upper handle, makes the cutting position less awkward, and utilizes body weight. This allows more power to be transferred to the cutting edges.
- b. Use the correct cutting tool for the type, size, and hardness of the metal to be cut.
- c. Keep cutter jaws at right angles to piece being cut. Cutting diagonally may twist jaws
- d. Do not twist or pry with tool while cutting.
- e. Do not exceed the full cut on a material whose hardness is unknown. Test hardness with slow pressure to see if material is being cut. The size of the metal you are cutting is not as important as its hardness.
- f. Do not exceed the cutter capacity that is marked on the jaw of the tool or its rating capacity in this catalog.
- g. Keep jaw bolts tight and joints oiled at all times.
- h. Maintain the original jaw bevel angles when sharpening out of line or chip cutting edges.



Safety Do's and Dont's

Wear your gloves and safety glasses at all times!

Do wear safety shoes.

Do remove oil or grease from your hands, from tools and from the floor and area where you will be working.

Do remember that metal flies when cut. The harder the metal, the farther it will fly.

Do warn those in the area when you intend to use a cutter and protect your fellow workers from flying metal.

Do use all tools as recommended.

Don't attempt to use a cutting tool, hand or power, until you fully understand its use.

Don't forget that metals may fly and cause injury.

Don't use cutters for any application except those listed in this catalog.

Don't use H.K. Porter cutters on energized circuits, wire, or cable.

Safety Precautions



DANGER

Indicates a high probability that death, severe bodily injury or major property damage could result.



Hard metals may snap off or fly through the air when cut. Always wear safety glasses and warn workers nearby to prevent them from being injured from flying metal. To prevent injury from flying metal, take precautions such as wrapping a cloth or rag around the cutting jaws so metal pieces can not fly.



WARNING

Is serious but less inevitable. There is some probability that death, severe bodily injury or property damage could result.



The "Safety Alert Symbol" symbol to the left is used to call attention to instructions concerning personal safety. Watch for this symbol, it points out important safety precautions. It means: "ATTENTION! Stay alert, personal safety may be in danger!" Read the message that follows this symbol and be alert to the possibility of personal injury or death resulting from misuse.

The use of any industrial tool may present hazards which can result in serious injury or death. The H.K.Porter® tools listed in this catalog are not exceptions to this rule.











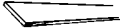



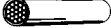



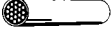

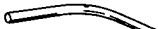

















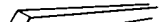



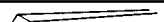

CAUTION

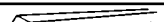
Is less serious but still demands attention. Indicates a hazard which may result in minor injury or property damage.

READ AND UNDERSTAND ALL DIRECTIONS BEFORE OPERATING ANY H.K. PORTER® MANUAL, HYDRAULIC OR PNEUMATIC TOOL

Cutter Selection

 BARS, FLAT	 CABLE, PRESTRESSED	 NUT SPLITTING	 WIRE, FENCE
 BARS, ROUND	 CABLE, RUBBER COVERED	 PADLOCK HASPS	 WIRE, GUY
 BARS, SQUARE	 CABLE, SOFT, LARGE	 PIPE, PVC	 WIRE, HOT
 BOLTS, RODS, SCREWS, RIVETS	 CABLE, STEEL	 PLASTIC, FIBER	 WIRE, COPPER
 CABLE (ACAR)	 CHAIN	 ROD REINFORCING	 WIRE, MESH
 CABLE (ACSR)	 CHAIN, HARD ALLOY	 ROD STRAIGHTENER	 WIRE ROPE
 CABLE, ALUMINUM	 EHS GUY STRAND	 STRAPPING STEEL	 WIRE SHELVING
 CABLE COMMUNICATIONS	 METALS, HARD	 TIRE CHAINS	 WIRE, SOLID
 CABLE, COPPER	 METALS, MEDIUM HARD	 TRUCK TIRE BEADS	 WIRE, SPRING
 CABLE, LEAD COVERED	 METALS, SOFT	 WIRE, BOX BINDING	 WIRE, STAINLESS STEEL
 CABLE, POWER	 NAILS, COTTER PINS	 WIRE, ELECTRIC	 WROUGHT IRON

1. What is the material to be cut?

(See above chart)

2. What size is the material to be cut?

Capacities of all hand-operated cutters are shown opposite each catalog listing. Power tool capacities are shown in the Power Tool Selector chart. Do not exceed listed capacities.

3. How hard is the material to be cut?

Many of the materials illustrated in the chart above are made in varying degrees of hardness. The maximum hardness ratings that each hand and power tool is designed to cut are shown under each tool in this catalog.

Extra Hard Metals:

Up to Brinell 455/Rockwell C48

Hard Metals:

Up to Brinell 400/Rockwell C42

Medium Hard Metals:

Up to Brinell 300/Rockwell C31

Soft Metals:

Up to Brinell 200/Rockwell C15

4. Will numerous or few cuts be made in a day?

The frequency of cuts to be made should be taken into consideration when choosing a cutter. HKP manufacturers inexpensive hand cutters for light-duty work, heavy-duty cutters for tougher jobs, and hydraulic and pneumatic cutters for extremely hard materials and production cutting.

5. Is speed a factor in the cutting?

Choose the proper cutter to fit the job requirements, whether an occasional cut is called for or fast, continuous, industrial production cutting.

Still not sure?

Send material samples to:

Cooper Hand Tools - Sumter Plant

Industrial Park

Sumter, SC 29154

Attn: HKP Test Material

NOTE: PROVIDE ANSWERS TO AS MANY OF THE QUESTIONS AS POSSIBLE.



WARNING

- Always wear safety glasses/goggles when cutting.
- Cut in a safe area; consider the safety of others in the immediate area.
- The harder the material being cut, the likelier it is to become airborne during cutting.
- Use tools correctly! (Refer to "Engineering Information" section of this catalog)
- Use the correct tool for the work being performed.
- Maintain tools, power supplies, and hoses in safe working condition.



Never use any H.K. Porter cutters on energized circuits, wire, or cable.

Quality Features of H.K. Porter® Cutters

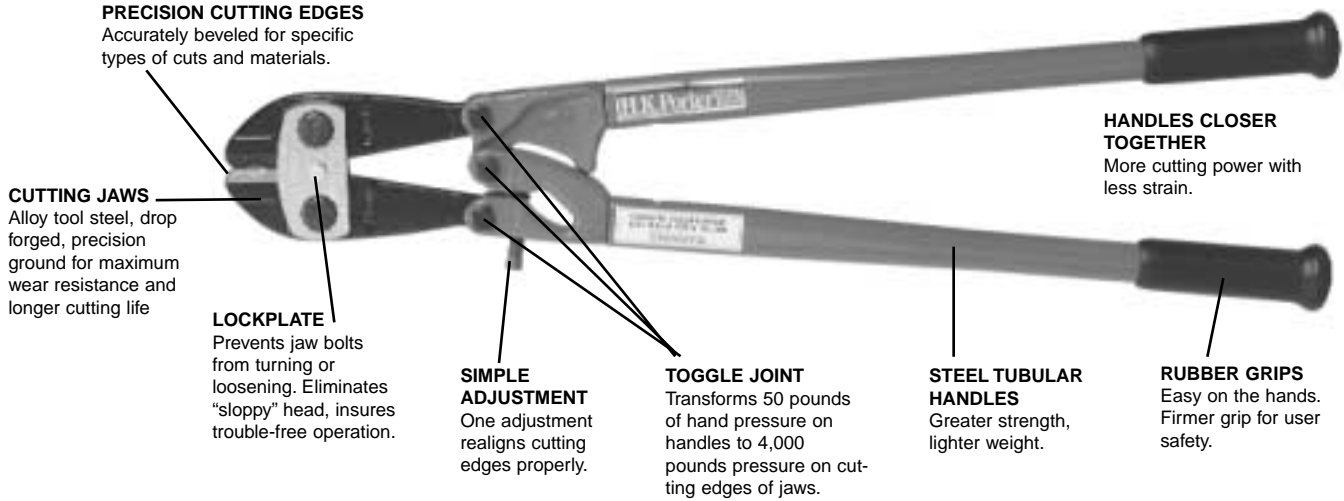

Jaw Designs

There are four basic jaw designs. They are engineered to give long, trouble-free life and the most efficient cutting of the materials which they are designed to cut.

1 ANGULAR JAWS
30° offset jaws have clipper-cut blades, designed for cutting close or flush to a surface. Cuts soft or medium-hard material.

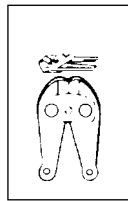

2 ALL-PURPOSE JAWS
Can have center- or clipper-cut blades used for broad cutting applications.

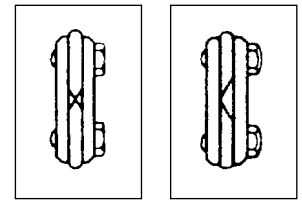

3 SHORT-NOSED JAWS
Center-cut, carbide-tipped blades for cutting hard- and non-alloy chains and padlock hasps.

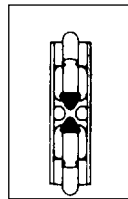

4 HEAVY-DUTY STRAP JAWS
Straps keep the cutting edges aligned under the most demanding applications.

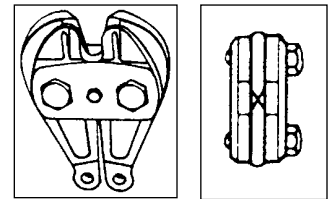

Cutting Blades

Four different cutting blade styles are available for specific types or broad ranges of cutting applications.

1 CENTER-CUT BLADES
Slightly rounded cutting edges, beveled on both sides, broaden cutting applications.

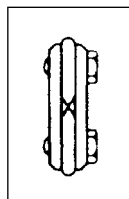

2 CLIPPER-CUT BLADES
Blades are beveled on only one side for smooth flush cuts that are close to workpiece.

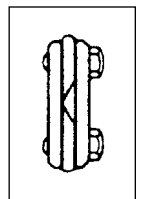

3 SHEAR-CUT BLADES
Designed to cut coarse- or fine-strand cable with minimal strand distortion.

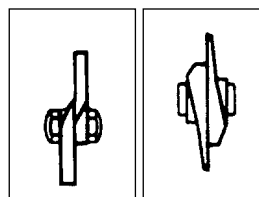

4 END-CUT BLADES
Blades are at right angles to handles for easier handling and "head-on" close cutting of materials.

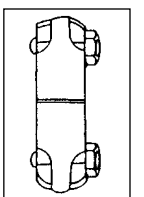

Never use any H.K. Porter cutters on energized circuits, wire, or cable.

! DANGER

Rod and Bar

Type and size of material to be cut - Maximum Capacity

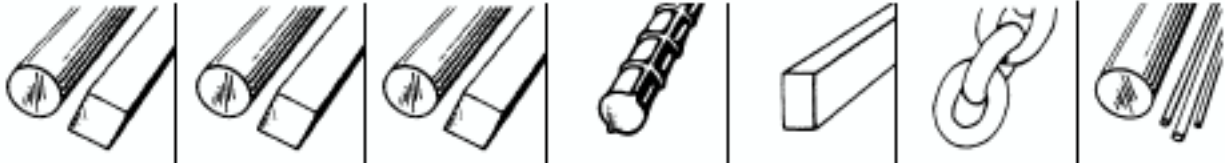

Cutter Head Assembly Cat. No.	Steel Low Carbon to 90,000 lb (40,824 kg) Tensile		Steel High Carbon to 130,000 lb (58,968 kg) Tensile		Steel High Alloy to 180,000 lb (81,648 kg) Tensile		Reinforcing Bars to 75,000 lb (34,020 kg) Tensile to Grade 75		Stainless Steel to 180,000 lb (81,648 kg) Tensile to Rockwell 40		Chain High Alloy to 180,000 lb (81,648 kg) Tensile to Rockwell 40		Aluminum Brass Copper Rod Bar	
	Inch	mm	Inch	mm	Inch	mm	Inch	mm	Inch	mm	Inch	mm	Inch	mm
W75000	3/4	19	3/4	19	5/8	16	5/8	16	5/8	16	5/8	16	3/4	19
W11800	1 1/8	29	1 1/8	29	1	25	1	25	1	25	1	25	1 1/8	29
W1770A	9/16	14	1/2	13	Do Not Cut		Do Not Cut		Do Not Cut		Do Not Cut		Do Not Cut	
W1770CD	5/8	16	9/16	14	1/2	13	1/2	13	1/2	13	1/2	13	Do Not Cut	
W1770TC	Do Not Cut		Do Not Cut		1/2	13	1/2	13	1/2	13	7/16	11	Do Not Cut	
9190C	3/8	10	3/8	10	5/16	8	5/16	8	5/16	8	5/16	8	3/8	10
9190NE	3/8	10	3/8	10	5/16	8	Do Not Cut		Do Not Cut		Do Not Cut		3/8	10
9190A	3/8	10	3/8	10	Do Not Cut		Do Not Cut		Do Not Cut		Do Not Cut		3/8	10
9290C	1/2	13	1/2	13	3/8	10	3/8	10	3/8	10	3/8	10	1/2	13
9290NE	1/2	13	1/2	13	3/8	10	Do Not Cut		Do Not Cut		Do Not Cut		1/2	13

Cable

Type and size of material to be cut - Maximum Capacity



Cutter Head Assembly Cat. No.	Copper Power Cable		Communication Cable (not self-support)		ACSR and ACAR Cable		Common Guy Strand Cable		Aluminum Power Cable		EHS Guy Strand Cable		Wire Rope Hard Including Stainless	
	Inch	mm	Inch	mm	Inch	mm	Inch	mm	Inch	mm	Inch	mm	Inch	mm
W177089	3	76	3 1/2	89	Do Not Cut		Do Not Cut		3	76	Do Not Cut		Do Not Cut	
W1770TN	3/4	19	Do Not Cut		3/4	19	Do Not Cut		3/4	19	3/8	10	3/4	19
WTC400C	4	102	4	102	Do Not Cut		Do Not Cut		4	102	Do Not Cut		Do Not Cut	
WRC125	Do Not Cut		Do Not Cut		Do Not Cut		1	25	Do Not Cut		3/4	19	1 1/4	32
WRC200	Do Not Cut		Do Not Cut		Do Not Cut		Do Not Cut		Do Not Cut		Do Not Cut		2	51
HRC300	Do Not Cut		Do Not Cut		Do Not Cut		Do Not Cut		Do Not Cut		Do Not Cut		3	76
27842	7/8	22	7/8	22	Do Not Cut		Do Not Cut		7/8	22	Do Not Cut		Do Not Cut	



Never use any H.K. Porter cutters on energized circuits, wire, or cable.

Pump Selection

Cat No.	Material	HKH02 Hand Pump	HKA01 Air/Hydraulic	HKE0501A 1/2 HP	HKE075 Series 3/4 HP	HKE150 Series 1 1/2 HP	HKE500 Series 5 HP
WTC400C	4" Power Cable	50 Sec.	10 Sec.	15 Sec.	9 Sec.	5 Sec.	2-3 Sec.
WTC400C	4" Comm. Cable	45 Sec.	10 Sec.	10 Sec.	9 Sec.	5 Sec.	2-3 Sec.
WTC400C	4" Aluminum	40 Sec.	10 Sec.	10 Sec.	9 Sec.	5 Sec.	2-3 Sec.

Cat No.	Material	HKH02 Hand Pump	HKA01 Air/Hydraulic	HKE0501A 1/2 HP	HKE075 Series 3/4 HP	HKE150 Series 1 1/2 HP	HKE500 Series 5 HP
WRC125	1" Common Guy	35 Sec.	15 Sec.	15 Sec.	8 Sec.	4 Sec.	2-3 Sec.
WRC125	3/4" EHS Guy	65 Sec.	10 Sec.	10 Sec.	9 Sec.	5 Sec.	2-3 Sec.
WRC125	1 1/4" Wire Rope	35 Sec.	15 Sec.	15 Sec.	12 Sec.	5 Sec.	2-3 Sec.
WRC200	2" Wire Rope	-	45 Sec.	60 Sec.	40 Sec.	25 Sec.	2-3 Sec.
W11800	1 1/8" Low Carbon Steel	Not Recommended	25 Sec.	25 Sec.	19 Sec.	8 Sec.	2-3 Sec.
W11800	1 1/8" High Carbon Steel	Not Recommended	25 Sec.	25 Sec.	19 Sec.	8 Sec.	2-3 Sec.
W11800	1" High Alloy Steel	Not Recommended	30 Sec.	25 Sec.	19 Sec.	10 Sec.	2-3 Sec.
W11800	1" Stainless Steel	Not Recommended	30 Sec.	25 Sec.	19 Sec.	0 Sec.	2-3 Sec.
W11800	1" Aluminum	Not Recommended	30 Sec.	25 Sec.	19 Sec.	8 Sec.	2-3 Sec.

Cat No.	Material	HKH02 Hand Pump	HKA01 Air/Hydraulic	HKE0501A 1/2 HP	HKE075 Series 3/4 HP	HKE150 Series 1 1/2 HP	HKE500 Series 5 HP
W75000	Low Carbon Steel 3/4" 90,000 Tensile	20 Sec.	10 Sec.	10 Sec.	7 Sec.	3 Sec.	2-3 Sec.
W75000	High Carbon Steel 3/4" 130,000 Tensile	40 Sec.	15 Sec.	Not Recommended		3 Sec.	2-3 Sec.
W75000	5/8" High Alloy 180,000 Tensile	25 Sec.	18 Sec.	10 Sec.	7 Sec.	3 Sec.	3-4 Sec.
W75000	5/8" Rebar	20 Sec.	15 Sec.	7 Sec.	7 Sec.	4 Sec.	2-3 Sec.
W75000	5/8" Stainless Steel 180,000 Tensile	30 Sec.	18 Sec.	15 Sec.	9 Sec.	3 Sec.	2-3 Sec.
W75000	3/4" Aluminum Rod	30 Sec.	15 Sec.	15 Sec.	7 Sec.	3 Sec.	2-3 Sec.
W1770A	9/16" Low Carbon	25 Sec.	10 Sec.	8 Sec.	7 Sec.	4 Sec.	2-3 Sec.
W1770A	1/2" High Carbon	30 Sec.	12 Sec.	7 Sec.	7 Sec.	4 Sec.	2-3 Sec.
W1770CD	5/8" Low Carbon	35 Sec.	10 Sec.	15 Sec.	7 Sec.	3 Sec.	2-3 Sec.
W1770TC	1/2" High Alloy	37 Sec.	10 Sec.	10 Sec.	7 Sec.	4 Sec.	2-3 Sec.

Cat No.	Material	HKH02 Hand Pump	HKA01 Air/Hydraulic	HKE0501A 1/2 HP	HKE075 Series 3/4 HP	HKE150 Series 1 1/2 HP	HKE500 Series 5 HP
W1770TC	1/2" Rebar	35 Sec.	10 Sec.	10 Sec.	8 Sec.	5 Sec.	2-3 Sec.
W1770TC	1/2" Stainless Steel	35 Sec.	10 Sec.	10 Sec.	7 Sec.	4 Sec.	2-3 Sec.
W177089	3" Copper Power Cable	60 Sec.	19 Sec.	15 Sec.	10 Sec.	5 Sec.	2-3 Sec.
W177089	3" Comm. Cable	60 Sec.	19 Sec.	15 Sec.	10 Sec.	5 Sec.	2-3 Sec.
W177089	3" Aluminum Cable	60 Sec.	19 Sec.	15 Sec.	10 Sec.	5 Sec.	2-3 Sec.
W1770TN	3/4" Wire Rope	35 Sec.	10 Sec.	12 Sec.	10 Sec.	5 Sec.	2-3 Sec.

Never use any H.K. Porter cutters on energized circuits, wire, or cable.

 **DANGER**

Workhead, Hose and Power Supply Selection

Power Tools and Portable Power Supplies

The most important factor in selecting the right hydraulic cutter for the job is identification of the material to be cut. Consider size, hardness (tensile strength) and type of material. Find material at top of chart on previous pages that is closest to the material to be cut. The correct cutter workhead will be found in the left-hand column under "Catalog Number."

All HKP workheads use only one hose to connect the workhead to the hydraulic pump. Standard hose can be ordered with a control wire for remote control, electric hydraulic pumps. Hoses without control wires are for use with hand, air/hydraulic or gasoline driven pumps.

Selecting the proper hydraulic pump depends on speed required and power source available. Cutting cycle times in table show pump best suited to your requirements. Pumps are available in hand-operated, air, electric or gasoline-driven models.

Power Tool Workheads

A workhead, sold as a unit, consists of the cutterhead, cylinder and control handle. Cutterheads and control handles are also available separately. In addition, the cutterhead and cylinder are sold as a unit for use with an HKP hand pump or air/hydraulic pump. And, in most cases, the cutterhead, cylinder, connecting hose and hand pump are also sold as a complete unit.



WORKHEAD
(For use with any HKP motor-driven hydraulic pump.)
CUTTERHEAD, CYLINDER AND CONTROL HANDLE.
Purchase as unit.



HAND-OPERATED HYDRAULIC CUTTER SYSTEM
HAND PUMP, HOSE, CYLINDER AND CUTTERHEAD.
Purchase as unit.



AUTOMATIC SYSTEM - PORTABLE POWER PACK
(electric/hydraulic pump), HOSE WITH CONTROL CABLE, AND WORKHEAD.
Purchase components separately.

CUTTERHEAD



Safety Precautions



Hard metals may snap off or fly through the air when cut. Always wear safety glasses and warn others nearby to prevent injury from flying metal. To prevent injury from flying metal, take precautions such as wrapping a cloth or rag around the cutting jaws.

 WARNING	 AVERTISSEMENT	 ADVERTENCIA
 Risk Of Eye Injury Wear ANSI Approved Eye Protection	Risque de dommages à l'œil Protection d'œil approuvée de l'usage A.N.S.I.	Riesgo de lesión del ojo Protección de ojo aprobada del desgarte ANSI

Ordering Replacement Parts

Order replacement parts through your Cooper Tools Distributor. Care should be taken to give accurate information regarding part numbers and descriptions. Include model numbers and serial numbers, as well. Although all parts are available at the factory, we suggest customers stock spare blades, seals, filters and oil for minimum delay in maintaining their units.

Operating Hydraulic Pumps Below -25°F (-31°C)

Unless otherwise requested at time of purchase, all HKP pumps are supplied with a high quality hydraulic oil. Pour point -25°F (-31°C) 150/165 viscosity SSU @ 100°F (38°C). When operating below -25°F, contact Cooper Tools Customer Service for oil recommendation.

Factory Repair Service

HKP units may be returned to factory for repair and reconditioning at any time. A free inspection and estimate of repair charges will be supplied if requested. All returns must be made by prepaid transportation.

Installation Recommendations

IMPORTANT: Electrical connections on cutterhead and hydraulic hose are for low voltage control only. **DO NOT PLUG CONTROL HANDLE INTO MAIN POWER SUPPLY.** The switches and wiring are designed for relay control only.

HE2200 series single phase Power Pack units are factory wired to run in counterclockwise direction and can be plugged into any outlet with proper power supply. Three phase units must be wired into customer's system. Be sure to wire so unit runs counterclockwise.

HKE102A, HKE302A, HKE402A, HKE602B and T5102 Hydraulic Power Sources are supplied in three phase only and can be wired to operate in either direction.

Try to install units so that hoses and wiring are not accessible to damage by fork lifts or other handling equipment.

When installing pumping unit overhead, be sure to have both cutterhead and hoses well below the pump. Do not loop hoses overhead as air pockets will result in slow reaction. Speed of cut should be approximately that indicated on the POWER TOOL SELECTOR CHART. If unit is cutting slower than indicated, **DO NOT ADJUST RELIEF VALVE. THE PRESSURE SETTING WILL NOT AFFECT THE SPEED.**

We recommend checking all connections for leaks, check for voltage drop or contact factory for assistance.

Power Tool Hoses & Accessories

- All HKP hydraulic hoses are made from the finest oil-and abrasion-resistant materials.
- This hose style is also offered in 1/4" or 3/8"
- Hoses are 2-ply rated, reinforced with two braids of high tensile steel wire and covered with oil and weather resistant rubber
- MSHA approved, 2-wire steel braid with 3/8" (10mm) – 18 NPTF fittings
- Order only enough hose to fit your particular application. Using too much hose, slows operator and production
- All control wire hoses come complete with 3-wire, twist-lock connectors for low voltage control only
- Couplings not included with hoses
- Special hoses are available upon request



Never use any H.K. Porter cutters on energized circuits, wire, or cable.

How to Sharpen Cutter Jaws

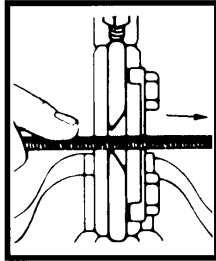
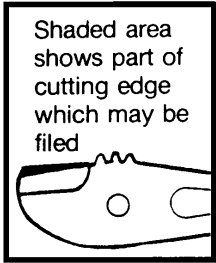

- Remove nicks in jaws by filing straight across cutting edges
- On jaws with equal bevels, file equally from each bevel, keep file flat against bevel
- On jaws with one large bevel, file on that bevel, small bevel must also be restored
- Jaws should not be razor sharp
- Approximately 1/64" (.4mm) should remain flat to form strong, durable edge
- Adjust tool according to the instructions below
- To sharpen shear-cut blades (blades that pass each other like scissors) remove nicks by filing straight across cutting edges
- Finish by running a flat file over inner jaw surface to remove burrs

How to Adjust the Cutter Jaws

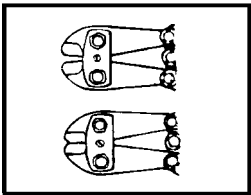
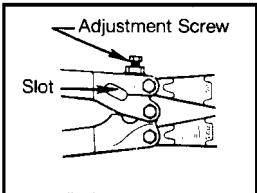

- An adjustment screw is located on the cutter handle above the toggle joints
- If jaw edges are too far apart with handles closed, tighten adjusting screw, this brings cutting edges together
- Cutting edges should be 1/64" (.4mm) apart for longest jaw life
- Oil all joints
- If jaw edges are too close together with the handles apart, loosen adjusting screw until it disappears from the narrow slot in the handle
- Make a cut with the tool in this position (cut will force the slot inward)
- Try to close the handles. If they do not close completely and jaw edges are 1/64" (.4mm) apart, tighten adjusting screw to meet the handle on far side of slot
- Oil all joints
- If jaws are too far apart with handles closed after making cut with adjusting screw backed off, tighten adjusting screw as explained above
- To sharpen shear-cut blades (blades that pass each other, like scissors), remove nicks by filing straight across the cutting edges
- Finish by running a flat file over inner blade surface to remove burrs.

Nicholson® File Recommendations

For Jaw Type	Use File Type
Straight	6", 8" or 10" Mill Bastard
Curved	8", 10" or 12" Half Round Bastard
Straight w/Notch	8", 10" Mill Bastard with one round edge
Notched	8" or 10" Round Bastard

- Choose file size according to size of jaw and/or radius of curve
- Half round files are the most versatile

Pneumatic Tools

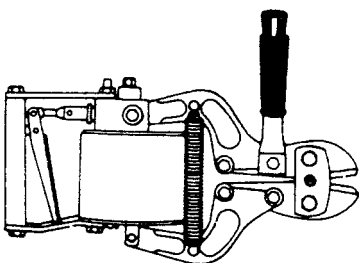

- All HKP air-powered tools require ram lateral input supply of 80-120 psi (6-8 kg/cm²)
- 9190 Series: 6.9 CFM or 8 CFM with factor of safety
- 9290 Series: 16.2 CFM or 18.7 CFM with factor of safety

! DANGER Never use any H.K. Porter cutters on energized circuits, wire, or cable.