

# Indicator M16

## Cylindrical 16-dia. Indicator

- Same basic design as the A16 Pushbutton Switch.
- UL and cUL approved (File No. E41515).

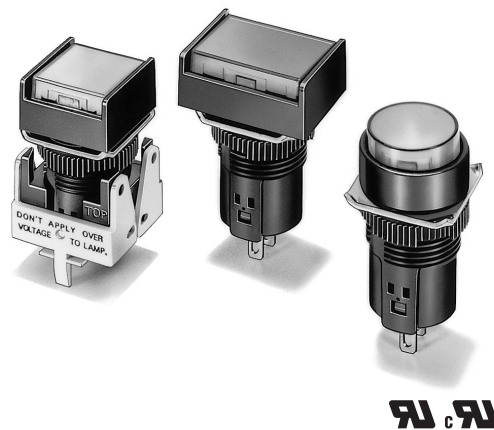

## Model Number Structure

### Model Number Legend

#### Completely Assembled

The model numbers used to order sets of Units are illustrated below. One set comprises the Display, Case, Lamp, and Socket.

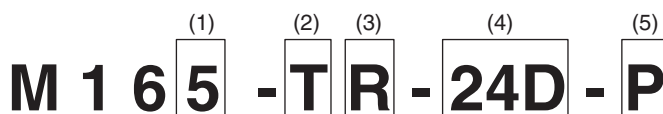

(1) Degree of Protection

Symbol	Protection
No symbol	IP40
5	IP65 oil-resistant

(2) Shape of Display

Symbol	Shape
J	Rectangular
A	Square
T	Round
3J	Rectangular (3-way guard)
BA	Square (24-mm square)

(3) Color of Display

Symbol	Color
R	Red
G	Green
Y	Yellow
PY	Pure yellow
W	White
A	Blue

(4) Light Source

Symbol	Type	Operating voltage	Rated voltage
5	Incandescent lamp	5 VAC/VDC	6 VAC/VDC
12		12 VAC/VDC	14 VAC/VDC
24		24 VAC/VDC	28 VAC/VDC
5D	LED	5 ±5% VDC	5 VDC
12D		12 ±5% VDC	12 VDC
24D		24 ±5% VDC	24 VDC

Voltage Reduction Unit (24-V Built-in LED)

Symbol	Type	Operating voltage	Rated voltage
T1	LED	90 to 121 VAC/VDC	110 VAC/VDC
T2		180 to 242 VAC/VDC	220 VAC/VDC

Solder terminals are available only with 100-V models.

The Voltage Reduction Unit is not available for models with PCB terminals.

(5) Terminal Type

Symbol	Terminal type
No symbol	Solder terminals
P	PCB terminals
S	Screw-Less Clamp

# Ordering Information

## ■ List of Models

### Ordering as a Set

The model numbers used to order sets of Units are given in the following tables. One set comprises the Display, Case, Lamp, and Socket.

### M16□-J (Rectangular) Models

#### Solder Terminal Models

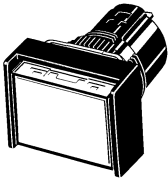
Appearance	Lighting	Operating voltage	IP40	IP65 oil-resistant	Display color symbol (See note.)
	LED without Voltage Reduction Unit	5 VDC	M16-J□-5D	M165-J□-5D	R: red Y: yellow G: green A: blue W: white PY: Pure yellow
		12 VDC	M16-J□-12D	M165-J□-12D	
		24 VDC	M16-J□-24D	M165-J□-24D	
	Incandescent lamp	5 VDC/VAC	M16-J□-5	M165-J□-5	
		12 VDC/VAC	M16-J□-12	M165-J□-12	
		24 VDC/VAC	M16-J□-24	M165-J□-24	

### M16□-A (Square) Models

#### Solder Terminal Models

Appearance	Lighting	Operating voltage	IP40	IP65 oil-resistant	Display color symbol (See note.)
	LED without Voltage Reduction Unit	5 VDC	M16-A□-5D	M165-A□-5D	R: red Y: yellow G: green A: blue W: white PY: Pure yellow
		12 VDC	M16-A□-12D	M165-A□-12D	
		24 VDC	M16-A□-24D	M165-A□-24D	
	Incandescent lamp	5 VDC/VAC	M16-A□-5	M165-A□-5	
		12 VDC/VAC	M16-A□-12	M165-A□-12	
		24 VDC/VAC	M16-A□-24	M165-A□-24	

### M16□-T (Round) Models

#### Solder Terminal Models

Appearance	Lighting	Operating voltage	IP40	IP65 oil-resistant	Display color symbol (See note.)
	LED without Voltage Reduction Unit	5 VDC	M16-T□-5D	M165-T□-5D	R: red Y: yellow G: green A: blue W: white PY: Pure yellow
		12 VDC	M16-T□-12D	M165-T□-12D	
		24 VDC	M16-T□-24D	M165-T□-24D	
	Incandescent lamp	5 VDC/VAC	M16-T□-5	M165-T□-5	
		12 VDC/VAC	M16-T□-12	M165-T□-12	
		24 VDC/VAC	M16-T□-24	M165-T□-24	

**Note:** Enter the desired color symbol for the Display in □.

## Ordering Individually

Displays, Cases, Lamps, and Sockets can be ordered separately. Combinations that are not available as sets can be created using individual parts. Also, store the parts as spares for maintenance and repairs.

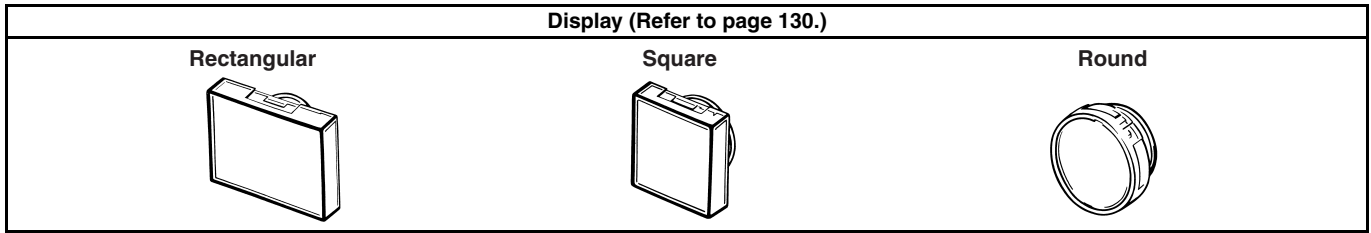

**Note:** Use IP40 Displays in combination with IP40 Sockets and use IP65 Displays in combination with IP65 Sockets.

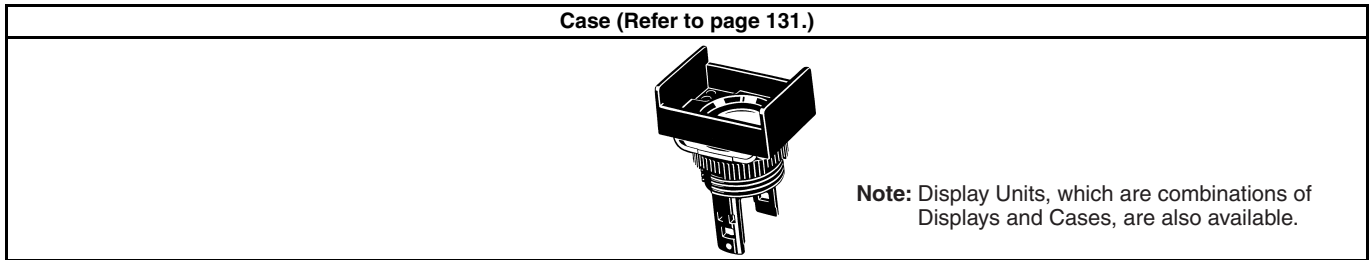



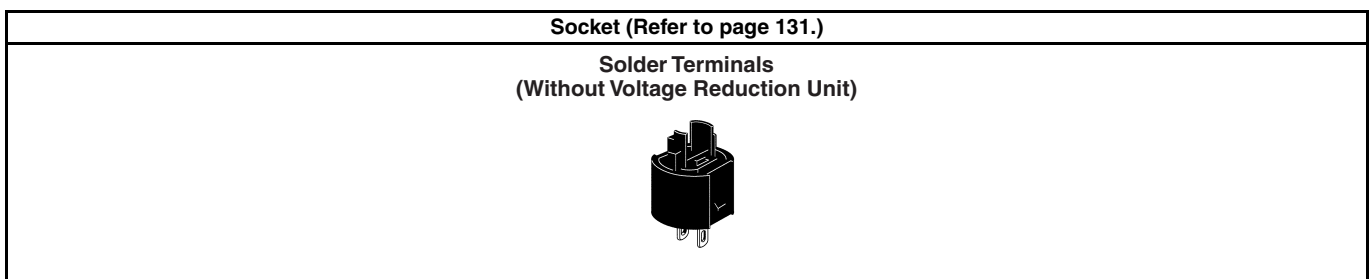
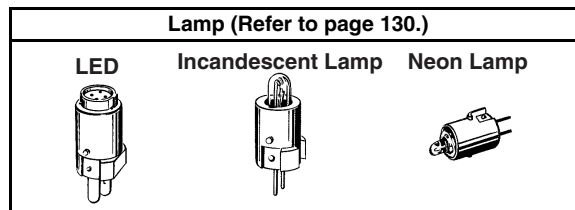



↓  
Lighted Models









**Note:** Socket Units, which are combinations of Lamps and Sockets, are also available.

## Display







### For LED-lighted Models

Sealing Appearance	IP40			IP65 oil-resistant		
	Rectangular	Square	Round	Rectangular	Square	Round
						
<b>Color of Display</b>						
Red	A16L-JR	A16L-AR	A16L-TR	A165L-JR	A165L-AR	A165L-TR
Yellow	A16L-JY	A16L-AY	A16L-TY	A165L-JY	A165L-AY	A165L-TY
Pure yellow	A16L-JPY	A16L-APY	A16L-TPY	A165L-JPY	A165L-APY	A165L-TPY
Green	A16L-JGY	A16L-AGY	A16L-TGY	A165L-JGY	A165L-AGY	A165L-TGY
White	A16L-JW	A16L-AW	A16L-TW	A165L-JW	A165L-AW	A165L-TW
Blue	A16L-JA	A16L-AA	A16L-TA	A165L-JA	A165L-AA	A165L-TA

**Incandescent Lamps (With the exception of green, the Units are the same as for LEDs.)**

Sealing Appearance	IP40			IP65 oil-resistant		
	Rectangular	Square	Round	Rectangular	Square	Round
						
<b>Color of Display</b>						
Red	A16L-JR	A16L-AR	A16L-TR	A165L-JR	A165L-AR	A165L-TR
Yellow	A16L-JY	A16L-AY	A16L-TY	A165L-JY	A165L-AY	A165L-TY
Pure yellow	A16L-JPY	A16L-APY	A16L-TPY	A165L-JPY	A165L-APY	A165L-TPY
Green	A16L-JG	A16L-AG	A16L-TG	A165L-JG	A165L-AG	A165L-TG
White	A16L-JW	A16L-AW	A16L-TW	A165L-JW	A165L-AW	A165L-TW
Blue	A16L-JA	A16L-AA	A16L-TA	A165L-JA	A165L-AA	A165L-TA

### Neon Lamps

Sealing Appearance	IP40			IP65 oil-resistant		
	Rectangular	Square	Round	Rectangular	Square	Round
						
<b>Color of Display</b>						
Red	A16L-JRN	A16L-ARN	A16L-TRN	A165L-JRN	A165L-ARN	A165L-TRN
Green	A16L-JGN	A16L-AGN	A16L-TGN	A165L-JGN	A165L-AGN	A165L-TGN
White	A16L-JWN	A16L-AWN	A16L-TWN	A165L-JWN	A165L-AWN	A165L-TWN

## Lamp

### LED

	Color	Operating voltage		
		5 VDC	12 VDC	24 VDC
	Red	A16-5DSR	A16-12DSR	A16-24DSR
Yellow	A16-5DSY	A16-12DSY	A16-24DSY	
Green	A16-5DSG	A16-12DSG	A16-24DSG	
White (See note.)	A16-5DSW	A16-12DSW	A16-24DSW	
Blue	A16-5DA	A16-12DA	A16-24DA	

**Note:** Use the white LED when the required illumination color is white or pure yellow.

### Incandescent Lamp

	Operating voltage	5 VAC/VDC	12 VAC/VDC	24 VAC/VDC
	Model		A16-5	A16-12

Neon Lamp

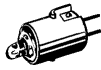
	Color of lamp	Color of Display	Operating voltage	
			100 VAC	200 VAC
	Red	White, red	A16-1NRN	A16-2NRN
Green	Green	A16-1NGN	A16-2NGN	

Case

Appearance	Classification		Model number
	IP40	Rectangular	A16-CJM
		Square	A16-CAM
		Round	A16-CTM
	IP65 oil-resistant	Rectangular	A165-CJM
		Square	A165-CAM
		Round	A165-CTM

Socket

Appearance	Classification			Model number
 Solder terminals	Solder terminals			M16-0
	PCB terminals			M16-0P
	Screw-Less Clamp			M16-S
	Solder terminals	Voltage-reduction lighting	100 V	M16-T1
			100 V	M16-T1-S
			200 V	M16-T2-S
Screw-Less Clamp				

Specifications

Approved Standards

Agency	Standards	File No.
UL, cUL (See note.)	UL508	E41515

Note: cUL: CSA, C22.2 No. 14

Ratings

Super-bright LED

Rated voltage	Rated current	Operating voltage	Built-in limiting resistance
5 VDC	30 mA (15 mA)	5 VDC ±5%	33 Ω (68 Ω)
12 VDC	15 mA	12 VDC ±5%	270 Ω (560 Ω)
24 VDC	10 mA	24 VDC ±5%	1,600 Ω (2,000 Ω)

Note: The values in parentheses are for blue Pushbuttons.

Incandescent Lamp

Rated voltage	Rated current	Operating voltage
6 VAC/VDC	60 mA	5 VAC/VDC
14 VAC/VDC	40 mA	12 VAC/VDC
28 VAC/VDC	24 mA	24 VAC/VDC

Neon Lamp

Rated voltage	Rated current	Operating voltage
110 VAC	1.5 mA	100 VAC ±10%
220 VAC	1.5 mA	200 VAC ±10%

Characteristics

Ambient operating temperature	-10°C to 55°C (with no icing or condensation)
Ambient operating humidity	35% to 85%
Ambient storage temperature	-25°C to 65°C

Note: Characteristics not provided above are the same as those for the A16.

Pushbutton Switches

## Screw-less Clamp

Item		Screw-less Clamp			
Recommended wire size		0.5 mm <sup>2</sup> twisted wire or 0.8 mm-dia. solid wire			
Usable wires and tensile strength	Twisted wire	0.3 mm <sup>2</sup>	0.5 mm <sup>2</sup>	0.75 mm <sup>2</sup>	1.25 mm <sup>2</sup>
	Solid wire	0.5 mm dia.	0.8 mm dia.	1.0 mm dia.	---
	Tensile strength	10 N	20 N	30 N	40 N
Length of exposed wire		10 ±1 mm			

## Dimensions

**Note:** 1. All units are in millimeters unless otherwise indicated.  
2. Refer to page 134 for details of panel cutout dimensions.

### Rectangular

#### M16-J

Solder terminals

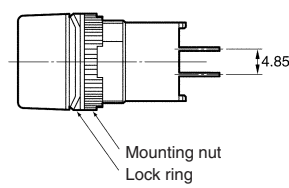
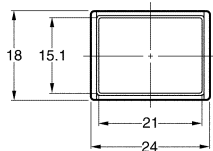
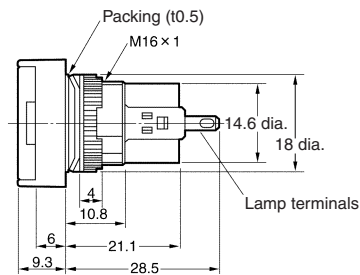
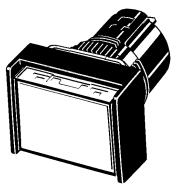

### Square

#### M16-A

Solder terminals

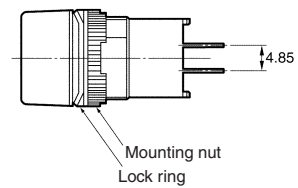
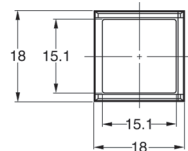
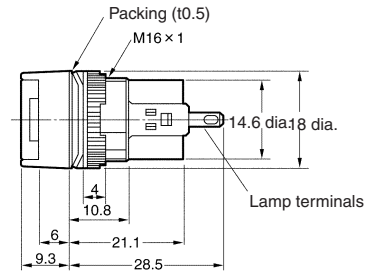
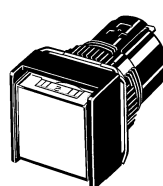

### Round

#### M16-T

Solder terminals

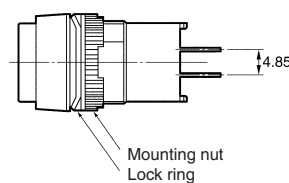
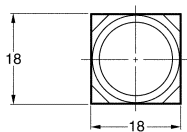
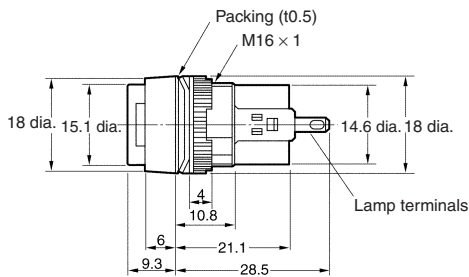

### Terminal Hole Dimensions

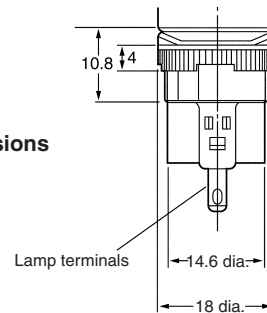
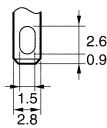

**Rectangular  
M16□-P**

PCB terminals

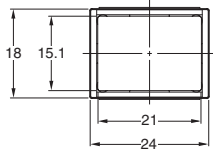

The rectangular model is given here as a representative example. Lamp terminals are provided even for non-lighting applications.

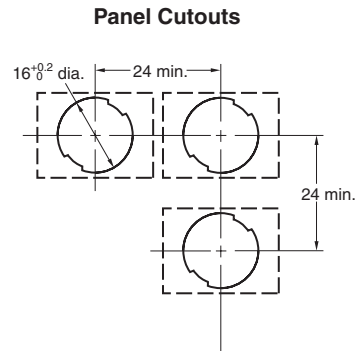
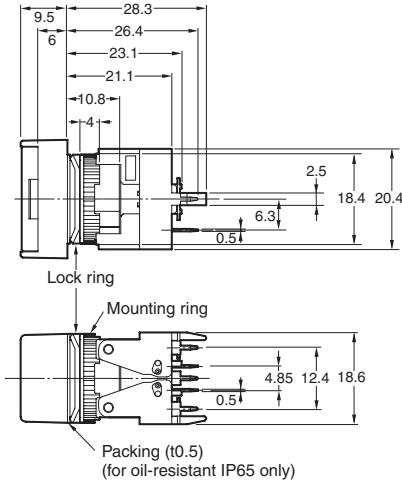

Recommended panel thickness: 0.5 to 3.2 mm

**Rectangular  
M16□-T1, T2**

Voltage-reduction lighting,  
solder terminals

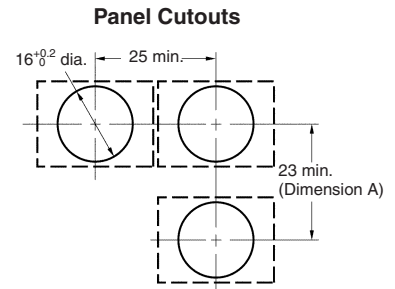
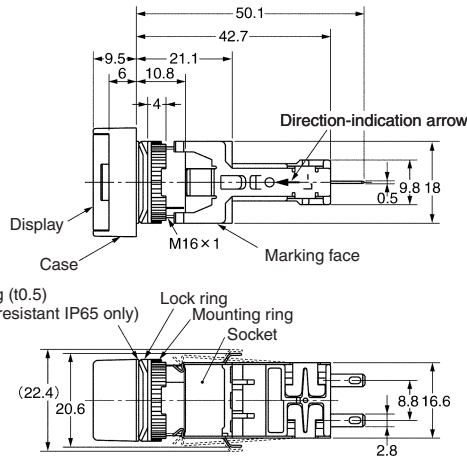
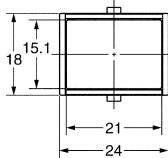
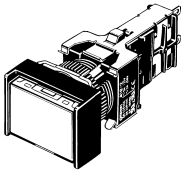

Recommended panel thickness: 0.5 to 3.2 mm

**Rectangular  
M16□-S**

Screw-Less Clamp

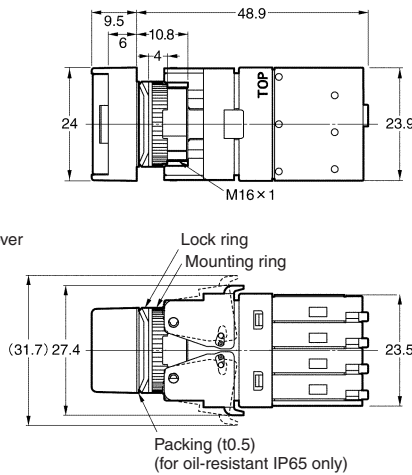
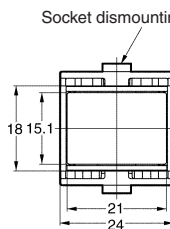
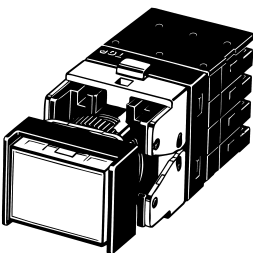

Pushbutton  
Switches

## Terminal Arrangement

### Solder Terminals

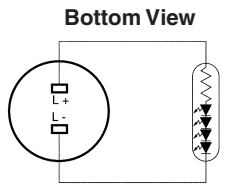

**Note:** The L+ is not shown on the Socket Unit.

### Screw-Less Clamp

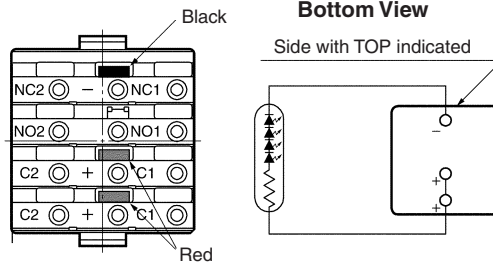

### Voltage-reduction Lighting

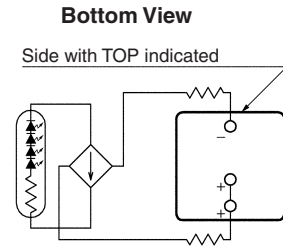

**Note:** Voltage-reduction lighting models with Screw-Less Clamps (A16L-□T1-2S, A16L-□T2-2S) incorporate voltage-reduction circuits.

## Panel Cutouts

### Solder Terminals

#### Solder Terminals Rectangular M16□-J

(Top View)

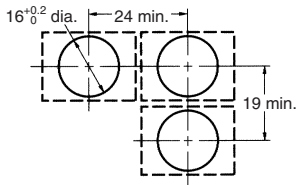

#### Square M16□-A Round M16□-T

(Top View)

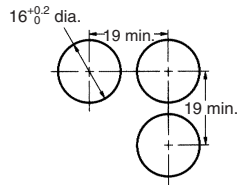

### Screw-Less Clamp

#### Rectangular M16□-S

(Top View)

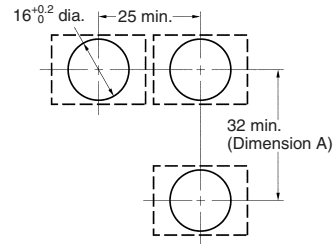

**Note:** 1. Make sure the thickness of the mounting panel is 0.5 to 3.2 mm. If, however, a Switch Guard or Dust Cover is used, the thickness of the mounting panel must be 0.5 to 2 mm.

2. If the panel is to be finished with coating, etc., make sure that the panel meets the specified dimensions after coating.

## Installation

Refer to the *Installation* section for the A16.



# Precautions

Refer to the *Technical Information for Pushbutton Switches* (Cat. No. A143) and the *Precautions* section for the A16.

## ■ Correct Use

### Mounting

When mounting the Case onto the Socket Unit, ensure that the orientation is correct. Perform mounting with the • mark on the Case and the TOP mark on the Socket Unit facing in the same direction.

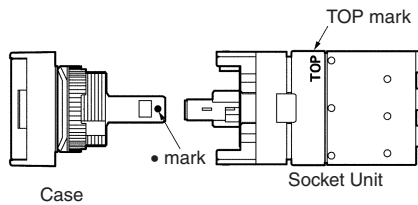

### Wiring

When using stranded wire, gather the ends of the strands together before wiring.

When wiring, insert the wire until it comes into contact with something. After wiring is completed, pull on the wires to confirm that they are connected securely.

After wiring, ensure that continuous pressure is not applied to the terminals.

Refer to internal connections diagrams and confirm the terminal numbers before performing wiring.

### Screw-Less Clamps

#### Mounting Procedure

1. Strip a length of 10 mm off the end of the wire (allowable range:  $10 \pm 1$  mm).
2. Bunch wire strands together and straighten them.
3. Insert the wire into the insertion hole while pressing the release button at the side of the hole. (Using a precision screwdriver is recommended.)
4. Let go of the release button to lock the wire into place.
5. After locking, pull on the wire gently to confirm that it is securely locked.

#### Removing Procedure

Remove wires by pulling them while pressing the release button.

**Note:** When reusing wires that have already been locked, cut off the end of the wire and strip the wire again before using.

ALL DIMENSIONS SHOWN ARE IN MILLIMETERS.

To convert millimeters into inches, multiply by 0.03937. To convert grams into ounces, multiply by 0.03527.

Cat. No. A127-E1-02

In the interest of product improvement, specifications are subject to change without notice.