

ISO Cylinder: Standard/Non-rotating Type Double Acting, Single/Double Rod

Series **C85**

ø8, ø10, ø12, ø16, ø20, ø25

Features

- Conforms to CETOP RP52P and ISO 6432 standards
- Double acting models
- High speed actuation
- Auto switch sensing option
- Special rod seal gives high resistance to dust ingress
- Easy & accurate mounting
- Exceptional service life
- Non-rotating and double rod options
- Air cushioning option



Technical Specifications

Bore size (mm)		8	10	12	16	20	25
Piston rod dia. (mm)		4	4	6	6	8	10
Piston rod thread		M4	M4	M6	M6	M8	M10 x 1.25
Port size		M5	M5	M5	M5	G 1/8	G 1/8
Action		Double acting, Single/Double rod					
Fluid		Air					
Proof pressure		1.5 MPa					
Max. operating pressure		1.0 MPa					
Min. operating pressure	Spring return	0.1 MPa	0.08 MPa	0.05 MPa	0.05 MPa		
	Spring extended				0.08 MPa		
Ambient and fluid temperature		-20 to 80°C (Built-in magnet: -10 to 60°C)					
Cushion		Rubber cushion, Air cushion (Except ø8) (Non-rotating: Rubber bumper only)					
Lubrication		Not required. Use turbine oil Class 1 ISO VG32, if lubricated.					
Rod boot	Nylon tarpaulin	—				Max. ambient temperature 60°C	
	Heat resistant tarpaulin	—				Max. ambient temperature 110°C*	
Piston speed		50 to 1500 mm/s					
Allowable kinetic energy	Rubber cushion	0.02 J	0.03 J	0.04 J	0.09 J	0.27 J	0.4 J
	Air cushion	—	0.17 J	0.19 J	0.4 J	0.66 J	0.97 J
Non-rotating accuracy		±1° 30'	±1° 30'	±1°	±1°	±0° 42'	±0° 42'
Stroke tolerance (mm)		0/+1				0/+1.4	

Symbol

Double acting, Single rod

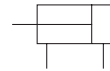

Rubber cushion

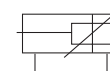

Air cushion

Double acting, Double rod

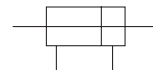

Rubber cushion

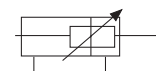

Air cushion

Non-rotating rod: Double acting, Single rod

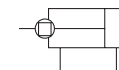

Replacement Parts

For Standard Cylinders

Bore size (mm)	Part no.	Note
20	C85-20PS	Every set includes: n°1 rod packing n°1 packing retaining washer n°1 retaining ring
25	C85-25PS	



CAD CD-ROM AVAILABLE



CATALOGUE E309-A AVAILABLE



PDF AVAILABLE ONLINE

How to Order: ISO Cylinder

Double acting
Single rod

C D 85 K N 16 40 C B

Double acting
Double rod

C D 85W E 16 40 C B

Built-in magnet

Nil	None
D	Built-in magnet

Type

Nil	Standard
K	Non-rotating rod (Rubber cushion only)

Mounting style

Symbol	Mounting
N	Basic integrated clevis
E*	Double end

* Double acting, Double rod:
Only double end style (E).

Auto Switch
Mounting Type

-	Without auto switch
B	Band mounted

Options

-	Standard ø32, ø40
XB6	High temperature 150° (without magnetic only)
XC6A	Stainless steel piston rod and rod end nut
XC6B	Stainless steel piston rod, rod end nut and mounting nut

Cushion

Nil	Rubber cushion (Standard)
C	Air cushion (Only "N" execution, bores 10 to 25 mm)

Auto Switch Specifications
Refer to switch section.

Bore size (mm)	Standard stroke (mm)**	Max. stroke (mm)		
		Standard	Non-rotating	Double rod
8*	10, 25, 40, 50, 80, 100	400	100	100
10				
12	10, 25, 40, 50, 80, 100, 125, 160, 200	400	200	200
16				
20	10, 25, 40, 50, 80, 100, 125, 160, 200, 250, 300	1000	1000	500
25				

* Not available with air cushion.
**Other strokes available on request.

Cylinder Mounting Accessories

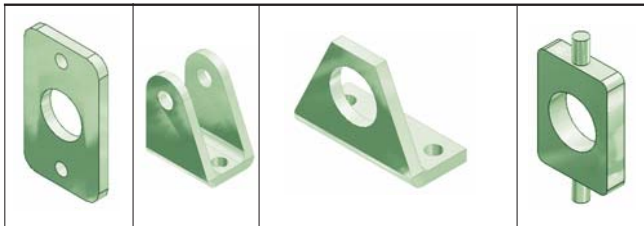

Bore size (mm)	Front/Rear Flange	Clevis	Foot (1pc)	Foot (2 pcs*)	Trunnion
8	C85-F10	C85C10	C85L-10A	C85L-10B	C85T10
10					
12	C85-F16	C85C16	C85L-16A	C85L-16B	C85T16
16					
20	C85-F-25	C85C25	C85L-25A	C85L-25B	C85T25
25					

*2 pcs with mounting nut 1 pc

Rod Accessories

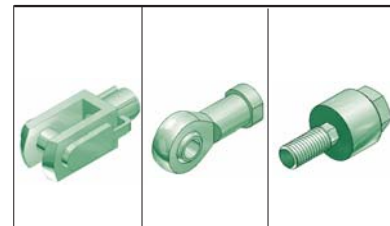

Bore size (mm)	Double Knuckle Joint	Single Knuckle Joint	Rod End Nut
8	GKM4-8	KJ4D	JA10-4-070
10			
12	GKM6-12	KJ6D	JA15-6-100
16			
20	GKM8-16	KJ8D	JA20-8-125
25			
25	GKM10-20	KJ10D	JA30-10-125

Dimensions

Double acting, Single rod
 Rubber cushion: C□85N **Bore** — **Stroke** — □
 Without magnet, Built-in magnet

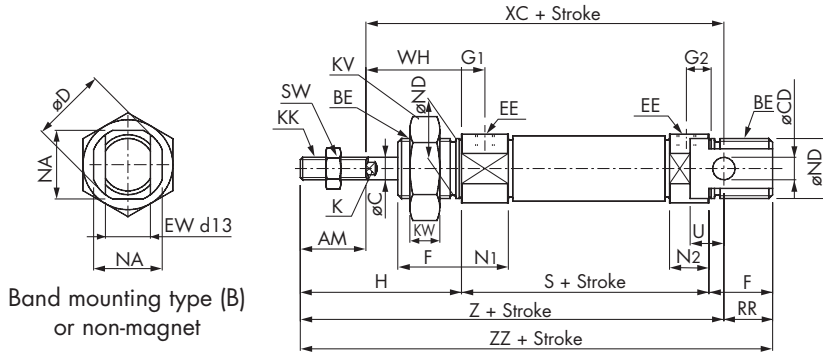

Band mounting type (B)
 or non-magnet

Air cushion: C□85N **Bore** — **Stroke** C — □
 Without magnet, Built-in magnet

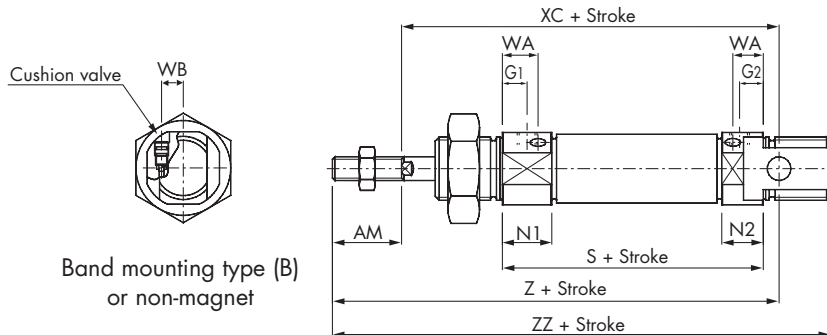

Band mounting type (B)
 or non-magnet

C□85KN
 Non-rotating, Piston rod (Rubber cushion only)

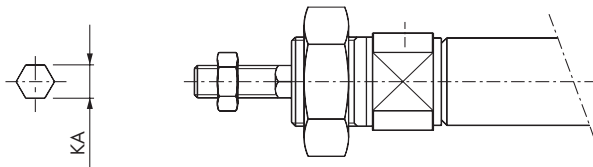

Rod cross section

Bore	AM	BE	øC	øCD H9	øD	EE	EW	F	G1	G2	WA	WB	H	HR	K	KA	KK	KV	KW	N1	N2	NA øND h8	RR	S	SW	U	WH	XC	Z	ZZ	
8	12	M12 x 1.25	4	4H9	16.7	M5	8	12	7	5	—	—	28	10	—	4.2	M4	19	6	11.5	9.5	15	12	10	46	7	6	16	64	76	86
10	12	M12 x 1.25	4	4H9	16.7	M5	8	12	7 ^(5.5)	5 ^(5.5)	10.5	4.5	28	10.5	—	4.2	M4	19	6	11.5 ^(13.5)	9.5 ^(13.5)	15	12	10	46 ⁽⁵³⁾	7	6	16	64 ⁽⁷¹⁾	76 ⁽⁸³⁾	86 ⁽⁹³⁾
12	16	M16 x 1.5	6	6H9	19.7	M5	12	17	8 ^(5.5)	6 ^(5.5)	9.5	5.5	38	14	5	6.2	M6	24	8	12.5 ^(12.5)	10.5 ^(12.5)	18.3	16	14	50 ⁽⁵⁴⁾	10	9	22	75 ⁽⁷⁹⁾	91 ⁽⁹⁵⁾	105 ⁽¹⁰⁹⁾
16	16	M16 x 1.5	6	6H9	19.7	M5	12	17	8 ^(5.5)	6 ^(5.5)	9.5	5.5	38	14	5	6.2	M6	24	8	12.5 ^(12.5)	10.5 ^(12.5)	18.3	16	13	56 ⁽⁵⁶⁾	10	9	22	82 ⁽⁸²⁾	98 ⁽⁹⁸⁾	111 ⁽¹¹¹⁾
20	20	M22 x 1.5	8		28	G 1/8	16	20	8	8	11.5 ⁽¹³⁾	8.5	44	17	6	8.2	M8	32	11	15 ⁽¹⁷⁾	15 ⁽¹⁷⁾	24	22	11	62	13	12	24	95	115	126
25	22	M22 x 1.5	10		33.5	G 1/8	16	22	8	8	11.5 ⁽¹³⁾	10.5	50	20	8	10.2	M10 x 1.25	32	11	15 ⁽¹⁷⁾	15 ⁽¹⁷⁾	30	22	11	65	17	12	28	104	126	137

() : In the case of air cushion.

Dimensions with Mounting Bracket

Double acting, Single rod
 Rod foot, Rod and head foot: C85L10^A, C85L16^A, C85L25^A

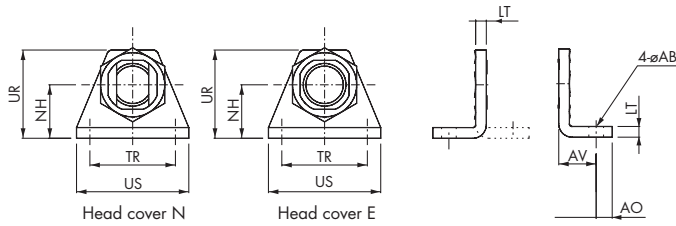

Rod flange, Head flange: C85F10, C85F16, C85F25

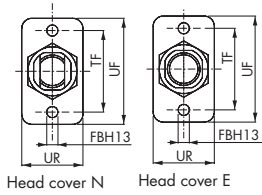

Rod trunnion, Head trunnion: C85T10, C85T16, C85T25

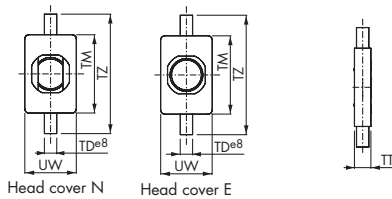

Clevis: C85C10, C85C16, C85C25

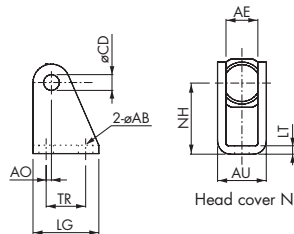

(mm)

Bore	Rod foot, Rod and head foot									Rod flange, Head flange				
	AO	US	øAB	LT	NH	TR JS14	AV	UR	W	UR	FBH13	FT	TF	UF
8	5	35	4.5	3.2	16	25	11	26	12.8	22	4.5	3.2	30	40
10	5	35	4.5	3.2	16	25	11	26	12.8	22	4.5	3.2	30	40
12	6	42	5.5	4	20	32	14	33	18	30	5.5	4	40	52
16	6	42	5.5	4	20	32	14	33	18	30	5.5	4	40	52
20	8	54	6.6	5	25	40	17	42	19	40	6.6	5	50	66
25	8	54	6.6	5	25	40	17	42	23	40	6.6	5	50	66

Bore	Rod trunnion, Head trunnion					Clevis								
	TT	UW	øTD e8	TM	TZ	øCD H9	AE	øAB	AO	AU	TR	LG	NH	LT
8	6	20	4	26	38	4	8.1	4.5	1.5	13.1	12.5	20	24	2.5
10	6	20	4	26	38	4	8.1	4.5	1.5	13.1	12.5	20	24	2.5
12	8	25	6	38	58	6	12.1	5.5	2	18.5	15	25	27	3.2
16	8	25	6	38	58	6	12.1	5.5	2	18.5	15	25	27	3.2
20	8	32	6	46	66	8	16.1	6.6	4	24.1	20	32	30	4
25	8	32	6	46	66		16.1	6.6	4	24.1	20	32	30	4

(): In the case of air cushion.

Accessory Dimensions

Piston Rod Ball Joint/DIN648-DIN24335

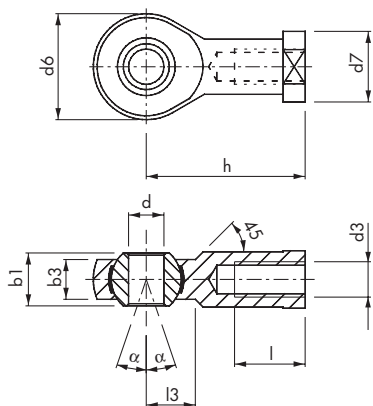

Double Knuckle Joint/ISO8140-DIN71752

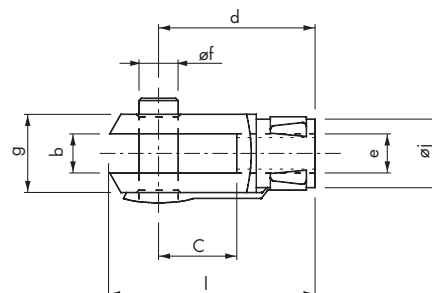

Bore	Model	Thread	d3	dh7	h	d6	b3	b1	l	d7	α°	l3
8	KJ4D	M4	5	27	18	6.0	8	10	11	7.5	10	
10	KJ4D	M4	5	27	18	6.0	8	10	11	7.5	10	
12	KJ6D	M6	6	30	20	6.75	9	12	13	6.5	10	
16	KJ6D	M6	6	30	20	6.75	9	12	13	6.5	10	
20	KJ8D	M8	8	36	24	9	12	16	16	13	12	
25	KJ10D	M10 x 1.25	10	43	28	10.5	14	20	19	13	14	

Bore	Model	Thread	e	b	d	f	g	c	i	a
8	GKM4-8	M4	4	16	4	8	8	6	8	
10	GKM4-8	M4	4	16	4	8	8	6	8	
12	GKM6-12	M6	6	24	6	10	12	8	12	
16	GKM6-12	M6	6	24	6	10	12	8	12	
20	GKM8-16	M8	8	32	8	12	16	10	16	
25	GKM10-20	M10 x 1.25	10	40	10	18	20	12	20	

Floating joint: Series JA

In the case of dimension without C

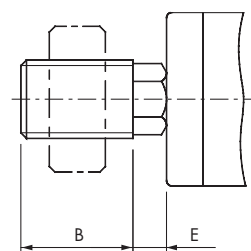
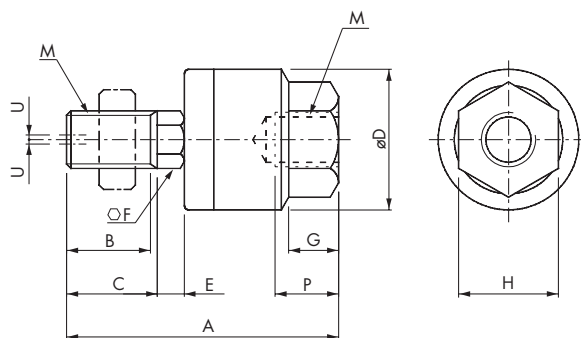

Bore	Model	M		A	B	C	D	E	F	G	H	Maximum screwed depth P	Allowable eccentricity U	Max. operating tension and compression power (kN)
		Nominal thread dia.	Pitch											
8, 10	JA10-4070	4	0.7	26	9	10	12	1.5	4	4	7	5.5	0.5	0.054
12, 16	JA15-6-100	6	1	34.5	12.5	14	16	2	6	5	10	7	0.5	0.123
20	JA20-8-125	8	1.25	44	17.5	—	21	4.5	7	7	13	8	0.5	1.1
25	JA30-10-125	10	1.25	49.5	19.5	—	24	5	8	8	17	9	0.5	2.5