



Description

The 3AG Fast-Acting Fuse solves a broad range of application requirements while offering reliable performance and cost-effective circuit protection.

Features

- In accordance with UL Standard 248-14
- Available in cartridge and axial lead format and with various forming dimensions
- RoHS compliant and Lead-free (except 10mA and 31mA rated items)

Applications

Used as supplementary protection in appliance or utilization equipment to provide individual protection for components or internal circuits.







Agency Approvals

Agency	Agency File Number	Ampere Range
	E10480 AU1410	312 Series 10mA - 10A 318 Series 31mA - 10A 312 Series 12A - 30A
	LR 29862	312 Series 10mA - 30A 318 Series 31mA - 10A
	NBK040205- E10480B/F	312/318 Series 1A - 10A
	E10480	318 Series 12A - 30A
	SU05001- 5005/5006/6005/6008	312/318 Series 1A/ 1.25A / 1.6A/ 2A - 10A
		312 Series 10mA - 10A 318 Series 31mA - 35A

Electrical Characteristics for Series

% of Ampere Rating	Ampere Rating	Opening Time
100%	.01 – 35	4 hours, Minimum
135%	.01 – 35	1 hour, Maximum
200%	.01 – 10	5 sec., Maximum
	12 – 30	10 sec., Maximum
	35	20 sec., Maximum

Electrical Characteristic Specifications by Item

Amp Code	Ampere Rating (A)	Max Voltage Rating (V)	Interrupting Rating	Nominal Cold Resistance (Ohms)	Nominal Melting I ² t (A ² sec)	Agency Approvals					
											
.10*	0.01	250	10mA ~ 1A 35A@250Vac 10KA@125Vac	177.4000	NA	x**				x**	x**
.031*	0.031	250		23.6500	0.0000300	x				x	x
.062	0.062	250		24.7000	0.000249	x				x	x
.100	0.1	250		11.2800	0.00102	x				x	x
.125	0.125	250		7.1450	0.00289	x				x	x
.150	0.15	250		5.1300	0.00550	x				x	x
.175	0.175	250		3.8750	0.00960	x				x	x
.187	0.187	250		3.4200	0.0128	x				x	x
.200	0.2	250		3.0200	0.0165	x				x	x
.250	0.25	250		2.0100	0.0355	x				x	x
.300	0.3	250		1.4050	0.0689	x				x	x
.375	0.375	250		0.8250	0.185	x				x	x
.500	0.5	250		0.4980	0.483	x				x	x
.600	.6	250		0.3620	0.880	x				x	x
.750	0.75	250		0.2445	1.84	x				x	x
001	1	250		0.1900	0.760	x		x	x	x	x
1.25	1.25	250		0.1385	1.45	x		x	x	x	x
01.5	1.5	250		0.1036	2.35	x			x	x	x
01.6	1.6	250		0.0934	2.80	x		x	x	x	x
1.75	1.75	250		0.0856	3.60	x			x	x	x
01.8	1.8	250	0.0825	3.85	x			x	x	x	
002	2	250	0.0704	5.20	x		x	x	x	x	
2.25	2.25	250	0.0594	7.20	x		x	x	x	x	
02.5	2.5	250	0.0513	9.54	x		x	x	x	x	
003	3	250	0.0427	14.0	x		x	x	x	x	
004	4	250	0.0293	28.5	x		x	x	x	x	
005	5	250	0.0224	50.0	x		x	x	x	x	
006	6	250	0.0178	118.0	x		x	x	x	x	
007	7	250	0.0146	118.0	x		x	x	x	x	
008	8	250	0.0122	166.0	x		x	x	x	x	
010	10	250	0.0093	298.0	x		x	x	x	x	
012	12	32	0.0072	234.6	x**	x***			x**		
015	15	32	0.0052	490.5	x**	x***			x**		
020	20	32	0.0035	1029	x**	x***			x**		
025	25	32	0.0024	2041	x**	x***			x**		
030	30	32	0.0019	3717	x**	x***			x**		
035	35	32	0.0013	7531							

NOTES:

* 10mA and 31mA are not RoHS compliant as the glass bead contains Pb.

** 312 Series only. Refer to Agency Approvals section of this document.

*** 318 Series only. Refer to Agency Approvals section of this document.

Temperature Derating Curve

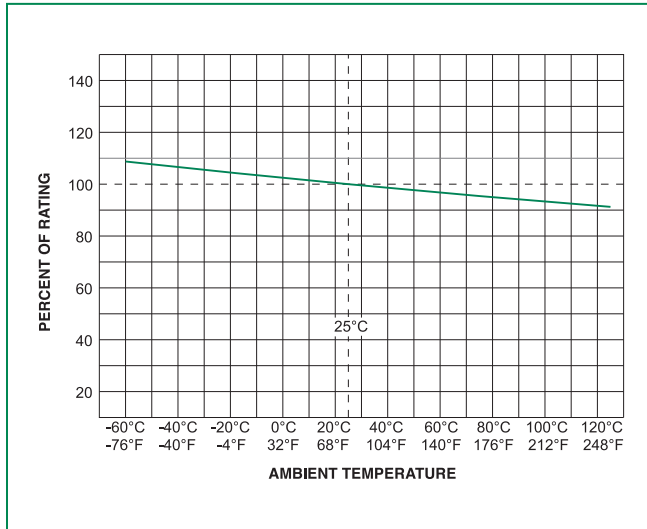

Average Time Current Curves

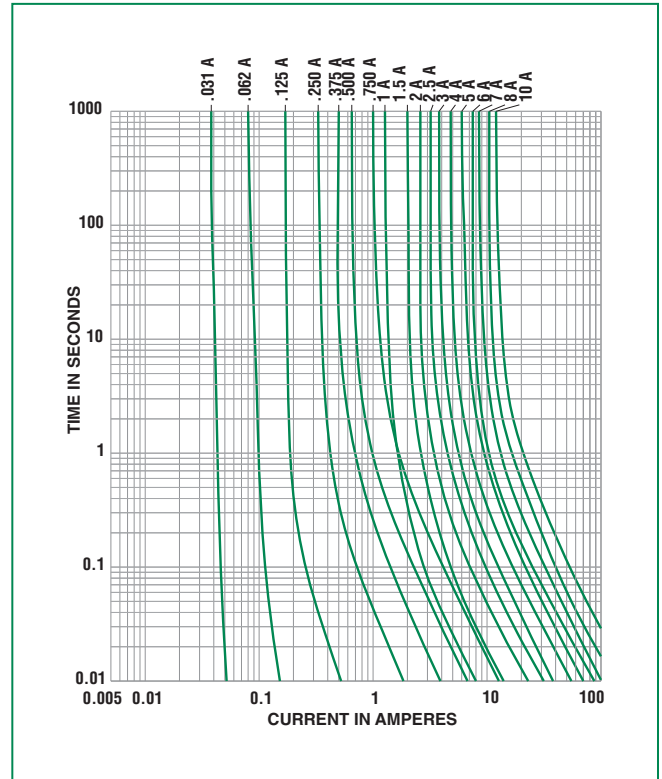

Soldering Parameters - Wave Soldering

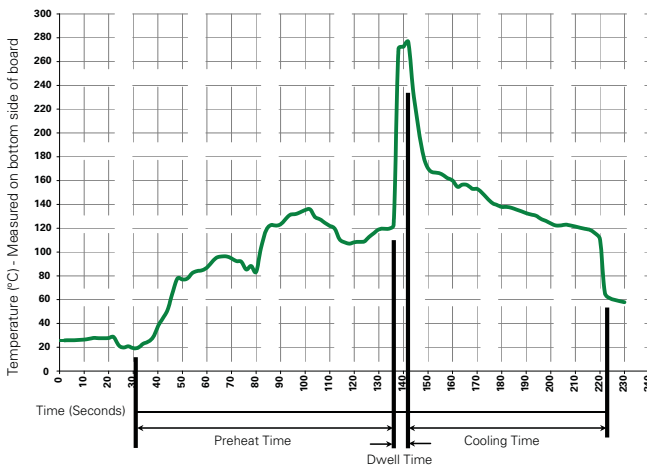

Recommended Process Parameters:

Wave Parameter	Lead-Free Recommendation
Preheat: (Depends on Flux Activation Temperature) (Typical Industry Recommendation)	
Temperature Minimum:	100° C
Temperature Maximum:	150° C
Preheat Time:	60-180 seconds
Solder Pot Temperature:	280° C Maximum
Solder Dwell Time:	2-5 seconds

Recommended Hand-Solder Parameters:

Solder Iron Temperature: 350° C +/- 5° C
 Heating Time: 5 seconds max.

Note: These devices are not recommended for IR or Convection Reflow process.

Product Characteristics

Materials	Body: Glass Cap: Nickel-plated brass Leads: Tin-plated Copper
Terminal Strength	MIL-STD-202G, Method 211A, Test Condition A
Solderability	Reference IEC 60127 Second Edition 2003-01 Annex A
Product Marking	Cap1: Brand logo, current and voltage ratings Cap2: Series and agency approval marks

Operating Temperature	-55°C to +125°C
Thermal Shock	MIL-STD-202G, Method 107G, Test Condition B: (5 cycles -65°C to +125°C)
Vibration	MIL-STD-202G, Method 201 A
Humidity	MIL-STD-202G, Method 103B, Test Condition A: High RH (95%), and Elevated temperature (40°C) for 240 hours
Salt Spray	MIL-STD-202G, Method 101D, Test Condition B

Part Numbering System

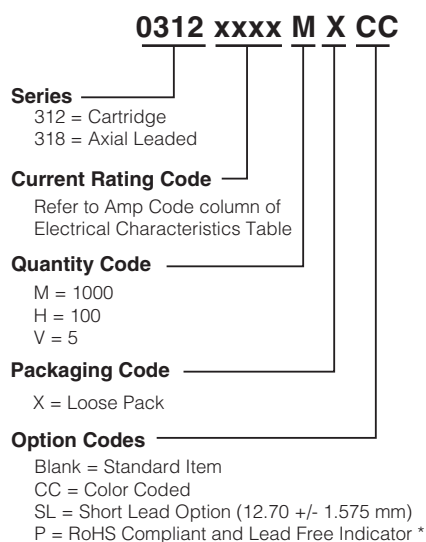

For additional information or information about other available options, please contact Littelfuse.

*Note: All 312 / 318 series fuses are now sold as RoHS compliant and Lead Free by default, with or without the "P" indicator.

Dimensions

Measurements displayed in millimeters (inches)

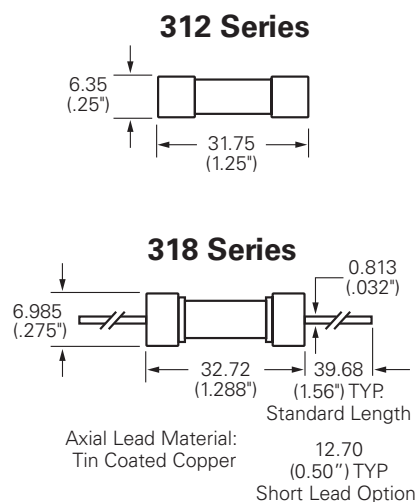

Packaging

Packaging Option	Quantity	Quantity & Packaging Code
312 Series (Cartridge Type)		
Bulk	5	VX
Bulk	100	HX
Bulk	1000	MX
Bulk	1000	MXCC
Bulk	100	HXCC
318 Series (Axial Leaded)		
Bulk	5	VX
Bulk	100	HX
Bulk	1000	MX
Bulk	1000	MXSL