

**40**mm sq.

# San Ace 40



## General Specifications

- Material ..... Frame: Plastics (Flammability: UL94V-0),  
Impeller: Plastics (Flammability: UL94V-0)
- Expected Life ..... Refer to specifications (L10: Survival rate: 90% at 60°C ,  
rated voltage, and continuously run in a free air state)
- Lead Wire ..... ⊕red ⊖black (Sensor) yellow (Control) brown
- Storage Temperature ..... -30°C to +70°C (Non-condensing)

**40×40×20mm** (Mass : 35g) **9GA type** High Airflow Low Power Consumption Fan



## Specifications

The following nos. have PWM controls, pulse sensors, and ribs.

| Model No.                       | Rated Voltage [V] | Operating Voltage Range [V] | PWM duty cycle* [%] | Rated Current [A] | Rated Input [W] | Rated Speed [min <sup>-1</sup> ] | Max. Airflow [m <sup>3</sup> /min] [CFM] | Max. Static Pressure [Pa] [inchH <sub>2</sub> O] | SPL [dB(A)] | Operating Temperature [°C] | Expected Life [h] |
|---------------------------------|-------------------|-----------------------------|---------------------|-------------------|-----------------|----------------------------------|--|--|-------------|----------------------------|-------------------|
| 9GA0405P6H001 <sup>(Note)</sup> | 5                 | 4.5 to 5.5                  | 100                 | 0.35              | 1.75            | 12,400                           | 0.33 11.7                                | 191 0.77   | 40          | -20 to +70                 | 40,000/60°C       |
| 9GA0405P6F001 <sup>(Note)</sup> |                   |                             | 100                 | 0.18              | 0.9             | 8,000                            | 0.21 7.4                                 | 79.5 0.32  | 28          |                            | 60,000/60°C       |
| 9GA0412P6G001                   | 12                | 10.2 to 13.8                | 100                 | 0.23              | 2.76            | 16,000                           | 0.42 14.8                                | 318 1.28   | 47          |                            | 40,000/60°C       |
|                                 |                   |                             | 0                   | 0.04              | 0.48            | 3,800                            | 0.10 3.5                                 | 17.9 0.07  | 14          |                            | 60,000/60°C       |
| 100                             |                   |                             | 0.14                | 1.68              | 12,400          | 0.33 11.7                        | 191 0.77                                 | 40   |             |                            |                   |
| 0                               |                   |                             | 0.04                | 0.48              | 3,800           | 0.10 3.5                         | 17.9 0.07                                | 14   |             |                            |                   |
| 100                             |                   |                             | 0.08                | 0.96              | 8,000           | 0.21 7.4                         | 79.5 0.32                                | 28   |             |                            |                   |
| 9GA0412P6F001                   |                   |                             | 0                   | 0.03              | 0.36            | 2,200                            | 0.06 2.1                                 | 6.0 0.02   | 10          |                            |                   |
| 9GA0424P6G001 <sup>(Note)</sup> | 24                | 20.4 to 27.6                | 100                 | 0.13              | 3.12            | 16,000                           | 0.42 14.8                                | 318 1.28   | 47          |                            | 40,000/60°C       |
| 9GA0424P6H001 <sup>(Note)</sup> |                   |                             | 100                 | 0.08              | 1.92            | 12,400                           | 0.33 11.7                                | 191 0.77   | 40          |                            | 60,000/60°C       |
| 9GA0424P6F001 <sup>(Note)</sup> |                   |                             | 100                 | 0.04              | 0.96            | 8,000                            | 0.21 7.4                                 | 79.5 0.32  | 28          |                            |                   |

Note: Rated voltage 5V and 24V fans do not rotate when PWM duty cycle is 0%.

\*PWM Frequency : 25kHz

Other sensor specifications are available as options. Please refer to the index (p. 504).

## Dimensions (unit: mm)

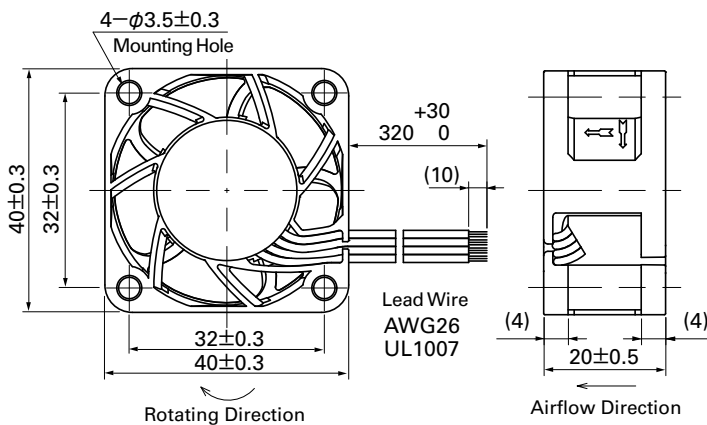

## Reference Dimensions of Mounting Holes and Vent Opening (unit: mm)

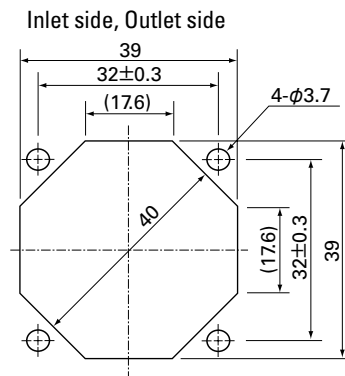

Options (unit: mm)

Finger Guards

Model : 109-059 Surface treatment : Nickel-chrome plating (silver)  
 : 109-059H : Cation electropainting (black)

Color

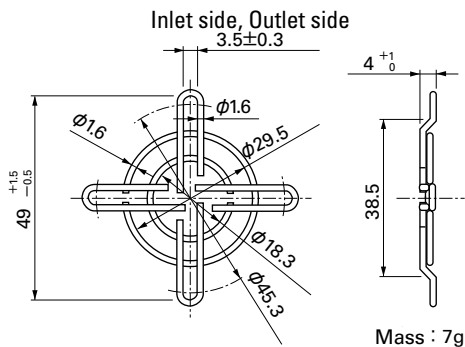

Airflow - Static Pressure Characteristics

PWM Duty Cycle

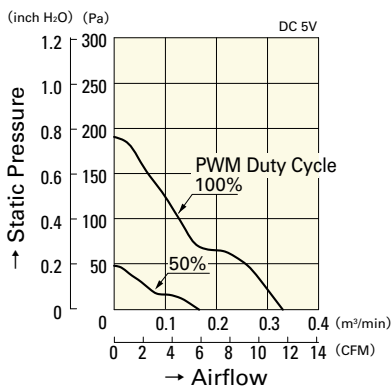

9GA0405P6H001

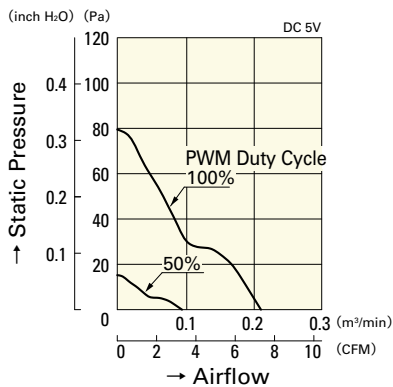

9GA0405P6F001

Operating Voltage Range

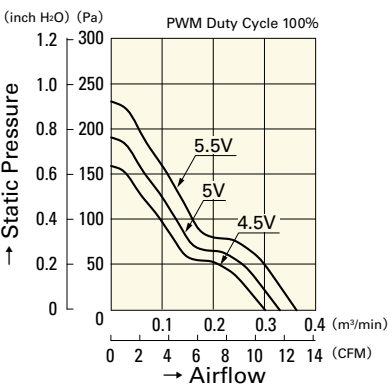

9GA0405P6H001

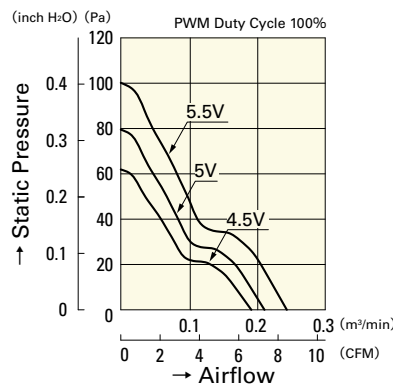

9GA0405P6F001

PWM Duty - Speed Characteristics Example

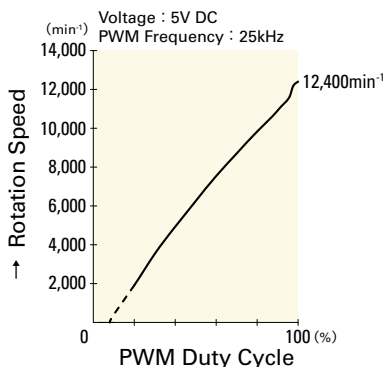

9GA0405P6H001

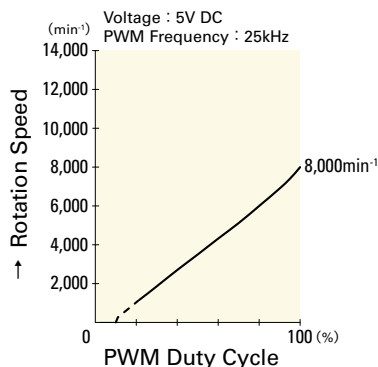

9GA0405P6F001

**40**mm sq.

**San Ace 40**

**40×40×20**mm [Mass : 35g]

**Airflow - Static Pressure Characteristics**

**PWM Duty Cycle**

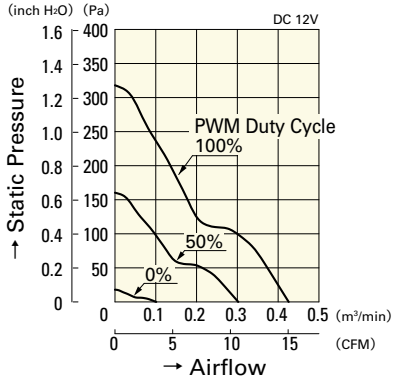

**9GA0412P6G001**

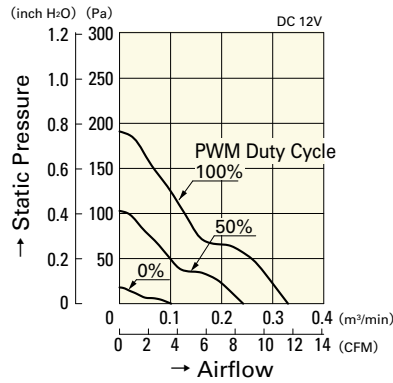

**9GA0412P6H001**

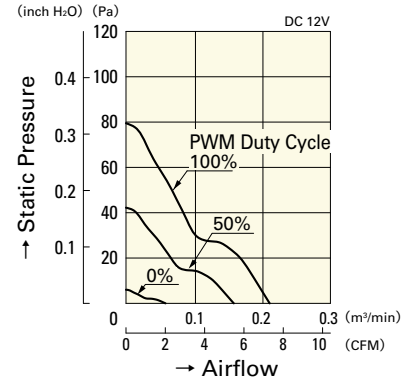

**9GA0412P6F001**

**Operating Voltage Range**

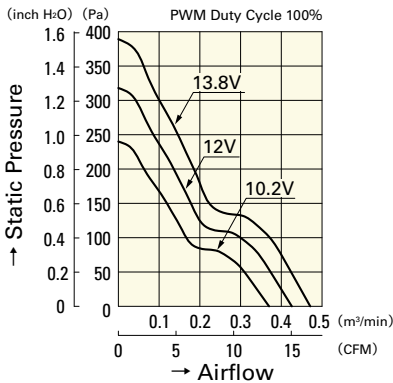

**9GA0412P6G001**

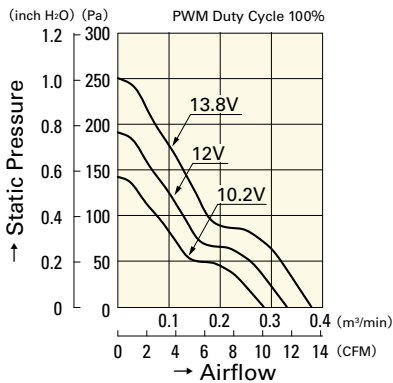

**9GA0412P6H001**

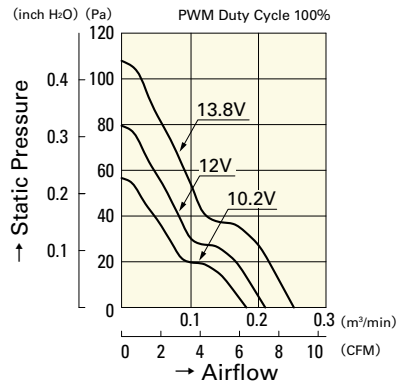

**9GA0412P6F001**

**PWM Duty - Speed Characteristics Example**

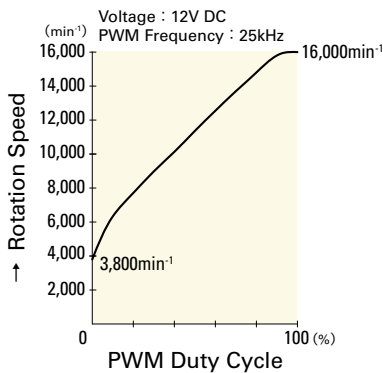

**9GA0412P6G001**

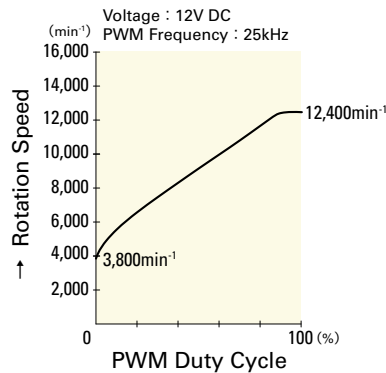

**9GA0412P6H001**

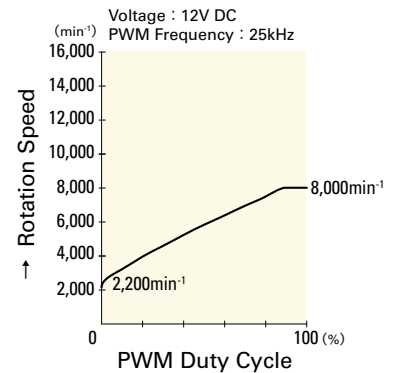

**9GA0412P6F001**

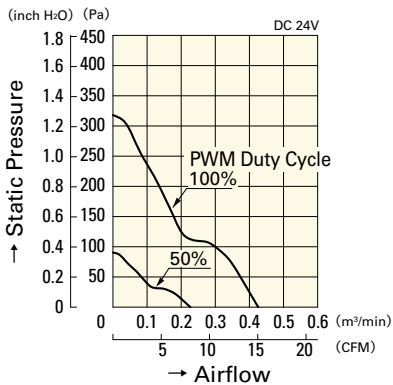

9GA0424P6G001

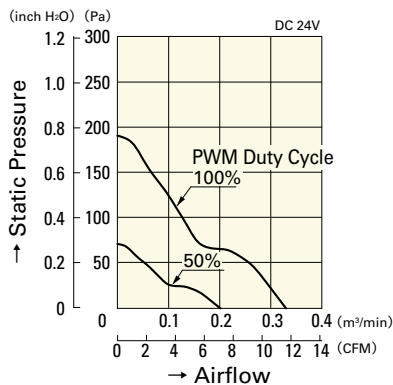

9GA0424P6H001

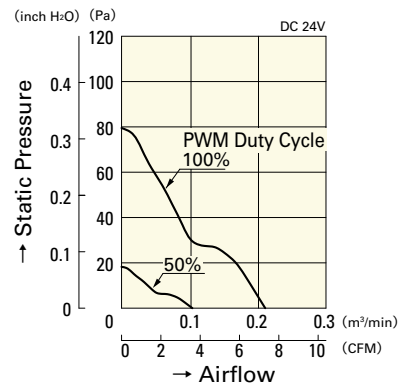

9GA0424P6F001

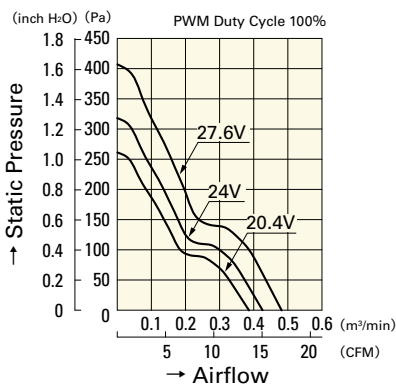

9GA0424P6G001

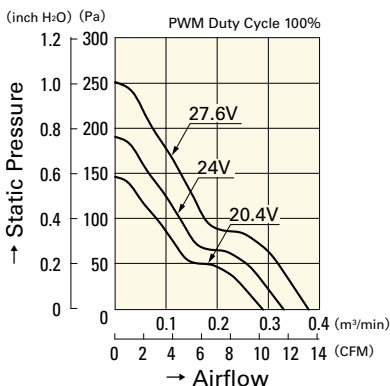

9GA0424P6H001

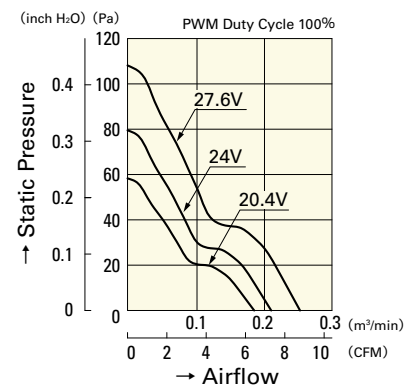

9GA0424P6F001

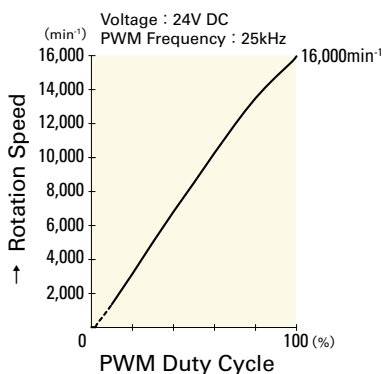

9GA0424P6G001

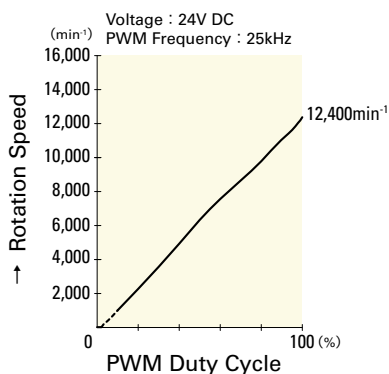

9GA0424P6H001

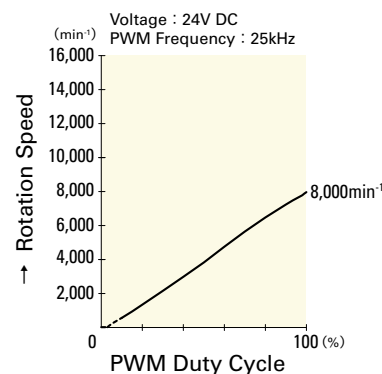

9GA0424P6F001

# Mouser Electronics

Authorized Distributor

Click to View Pricing, Inventory, Delivery & Lifecycle Information:

## Sanyo Denki:

[9GA0412P6G001](#) [9GA0412P6H001](#) [9GA0424P6F001](#) [9GA0424P6H001](#) [9GA0405P6H001](#) [9GA0405P6F001](#)  
[9GA0412P6F001](#) [9GA0424P6G001](#)