



ITT

Electronic Components

VEAM PT Connectors



Engineered for life

Rack & Panel Connectors

ITT is the world leader in rack and panel connectors, offering unmatched variety of shell configurations and insert arrangements, materials, plating and contact options. Many of our standard and custom designs meet the stringent requirements of ARINC 600, ARINC 404 (MIL-C-81659), and MIL-DTL-83733 standards.



www.ittcannon.com/rackandpanel

Circular/Filter/Hermetic Connectors

As a world leader in circular, filter and hermetic connectors, ITT can leverage its design and manufacturing expertise to fit virtually any application. Our expertise includes fast positive mating for a wide range of military applications, as well as numerous sizes and contact configuration for various harsh environments. ITT can also meet numerous specs, including NATO and MIL standards.



www.ittcannon.com/circulars • www.ittcannon.com/filter • www.ittcannon.com/hermetics

D-Subminiature Connectors

Cannon invented D-sub connectors in 1952. Our family of D-Subs now includes combinations of signal, power and RF, as well as severe service sealed connectors. Cannon D-Subs are available with an extensive line of backshells and accessories and are one of the most economical shielded connector solutions available. Qualified to the MIL-DTL-24308 specification.



www.ittcannon.com/dsubs

Fiber Optic Connectors and Cable Assemblies

Cannon fiber optic solutions provide an excellent performance/cost value. Performance can be tailored to the end system, and our use of superior materials and bonding agents provides highly effective solutions. Our wide variety of products includes fiber optic hybrid contacts, multi-channel, rack and panel, and hi-rel assemblies, including MIL and ARINC standard solutions.



www.ittcannon.com/fiberoptics

Microminiature Connectors

Cannon microminiature connectors offer high performance and reliability with exceptional versatility. Available in rectangular, circular and strip configurations for countless applications, many of our connectors meet or exceed applicable requirements of the MIL-DTL-83513 specification.



www.ittcannon.com/micro

ITT's Electronic Components business (www.ittcannon.com) is an international supplier of connectors, interconnects, cable assemblies, I/O card kits and smart card systems. As a worldwide leader in connector technology for nearly a century, ITT offers one of the industry's broadest product offerings, manufacturing capability worldwide, fast time to market, high volume/high yield capacity, robust design and Value-Based Product Development and an extensive sales and customer support network.



ITT

Introduction

Company History

The Company was originally founded in 1955 by Thorn Electrical Industries as a specialist component manufacturer, and following an alliance with the Bendix Connector Division, Thorn Bendix was formed to lead the development of a variety of electrical connectors including the PT/PTSE range. In 1986 the company was acquired by FKI plc and in 1993 the Company was bought by the management team, becoming TEC Ltd, and processes expanded into the supply of specialized harnesses and assemblies.

In October 1999 the Company was acquired by LITTON INDUSTRIES as part of the VEAM Connector Operations Group and was subsequently sold to ITT Industries in 2003 and became part of the ITT Electronic Components Group.

Table of Contents

Company History.....	3
Features and Benefits.....	4-5
Glossary of Terms.....	6
Terminology.....	7-8
Basic Nomenclature.....	9
Insert Arrangements.....	10-13
Polarization/Orientation.....	14
Jam Nut Variants.....	15-18
Panel Mount Variants.....	19-24
Plug Variants/CPT Range.....	25-30
Contacts.....	31-32
Protective Caps.....	33
Accessories	34-39
Audio Range.....	40-41
Connector with Accessories Cross Reference Chart.....	42

VEAM PT Connectors

Features and Benefits

Originally designed and manufactured by VEAM/TEC and now part of the ITT range, these connectors are made to the highest standards within the company's EN ISO 9001 quality systems. These multiple contact connectors offer equipment designers a high quality, miniature bayonet coupling connection whose components are already well established in the military markets such as fighting vehicles and communications. They are equally suitable for industrial applications where high reliability and cost effectiveness are prime requirements and the extensive range offers a compact, lightweight yet rugged solution for equipment design. The lightweight aluminum shells are plated to offer excellent corrosion resistance. Certain contact arrangements can also accommodate coaxial shielded contacts.

PT Connectors

Our PT (Pattern 105) range fully conforms to the rigorous requirements of British Standard BS9522 F0017. They are also compatible and fully intermateable with connectors meeting the requirements of US military specification MIL-C-26482. The PT range has solder terminations suitable for wire and printed circuit board applications.

PTSE Connectors

PTSE (Pattern 603) connectors fully conform to British Standard BS9522 N0001. As with the PT connectors they are compatible and fully intermateable with MIL-C-26482. The PTSE Connectors employ crimp front release rear removable contacts in a clip retention insert.

CPT Connectors

The CPT range is a proprietary design and is a commercial version of the PTSE crimp contact connectors. They are intermateable and inter-changeable with the PT and PTSE and offer similar mechanical and electrical performance. Usually supplied with factory bonded prewired contacts for over moulding (see Audio/Specials section). They employ a distortable rubber insert contact retention system.

Audio Connectors

The Audio Connectors are a development of the PT and CPT ranges. They are designed as lightweight, space saving connectors and are manufactured to meet the exacting requirements of modern and professional communications systems. All connectors have been approved by the Royal Signals and DERA Establishment, and have been used extensively on Clansman and Bowman radio systems for the UK Military.

Special Requirements

ITT has facilities for the design and production of special connectors for specific purposes. Examples are connectors with inbuilt EMI suppression filters, co-axial shielded contacts, special coupling mechanisms plus many alternative shell materials and finishes can be supplied to suit various conditions and applications



Features and Benefits

- Retained coupling nuts on plugs
- Heavy (arctic) ribbed coupling nuts available
- Many special variants/platings/materials
- Numerous contact arrangements from 2 to 61 contacts
- Alternate keyway polarization and insert orientations to prevent cross-plugging
- Available with grounding springs for EMC shielding
- Positive coupling 3 bayonet pin construction with audible mate
- Solder or crimp terminations
- Wide range of cable accessories



Materials

Shells:

High-grade aluminum alloy suitably plated

Insulator:

Polychloroprene rubber/self extinguishing/resistant to hydraulic fluids, lubricants etc,

Contacts:

Gold plated high conductivity copper alloy

Environmental Ratings

Temperature range

-55° to +125°C

Humidity

56 days

Low air pressure

44 mbar

Vibration

10 - 5000Hz, 0.75mm/10g_n duration 30 hr

Shock

981m/s² (100g_n) for 6 ms

Bump

390 m/s² (40g_n) 4000 bumps

Acceleration

490 m/s² (50g_n)

Mechanical endurance

500 matings

Salt mist

Severity 1 to BS2011 Kb (dependent on finish)

Sealing (PT series only)

<1 cm³/h at 100 kN/m² (1 bar)

Electrical Ratings

Proof voltage rating

2100 or 3000V d.c. or a.c. peak

Insulation resistance

5000MΩ minimum

Contact resistance

5 mΩ maximum

Shell to shell continuity

5 mΩ maximum (grounding spring styles)

Current rating

Contact size 20, 5 amps

@ 85° continuous

Contact size 16, 10 amps

Contact size 12, 20 amps

VEAM PT Connectors

Glossary of Terms

Shown below are some standard terms used to describe circular connectors and their features

Shell

The body of the connector

Insert

The dielectric or insulating inner core, holds contacts

Coupling Nut

Outer threaded or grooved ring which holds mated pair together

Jam Nut

Nut that holds receptacle to a panel

Bayonet Coupling

A non-threaded, triple ramp type of coupling

Contacts

The conductive element in a connector that makes the electrical connection between mated connectors

Pin Contact*

Male half of a mated pair of contacts

Socket Contact

Female half of a mated pair of contacts

Solder Contact

A contact to which wire is joined by soldering

Crimp Contact

A contact to which wire is joined by mechanical compression

Plug* (Free)

The male half of a mating pair of connectors which may hold male or female insert/contacts

Receptacle (Fixed)

The female half of a mating pair of connectors which may hold male or female insert/contacts

PCB contacts

Contacts that can be soldered to a printed circuit board or flex circuit

Plating

The metal finish applied to contacts and or shell components (protective)

Grommet

Resilient part at back of insert (attached or separate) gives wire moisture seal

Gland

Resilient ring in rear accessory provides seal on wire jacket

Sealing Plug

Plastic peg placed in unused grommet holes to seal

Grounding Fingers

A metal strap around the plug shell for positive electrical shell to shell connection

Hermetic

A connector with fused glass insert for air tightness

Mating/Un mating Forces

Torque required to couple/uncouple a mating pair

Backshell

An accessory which threads to back of shell

Strain Relief

A type of accessory which clamps wires for support

Potting Boot

A type of accessory which forms a mould for potting compound

EMI or RFI Backshell

A type of accessory to terminate wire/cable shielding

Interfacial Seal

A resilient gasket on the face of pin inserts gives moisture seal

Scoop Proof

Is a feature on some ranges of connectors to prevent damage to the pin contacts when mating connector pairs

*Note: Male half always goes into female



Dimensions shown in mm (inch)
Specifications and dimensions subject to change

www.ittcannon.com

Terminology: Cylindrical Connectors

The diagram opposite shows a typical cross-section of a mated pair of connectors, indicating the basic components.

Basic Components:

1. Body (Shell)
2. Insert (Dielectric Contact Holder) Pin or Socket
3. Contact (Wire End Termination) (Signal Joining Part)
4. Accessories (Wire Seals, Cable Seals, Wire Support, etc.)

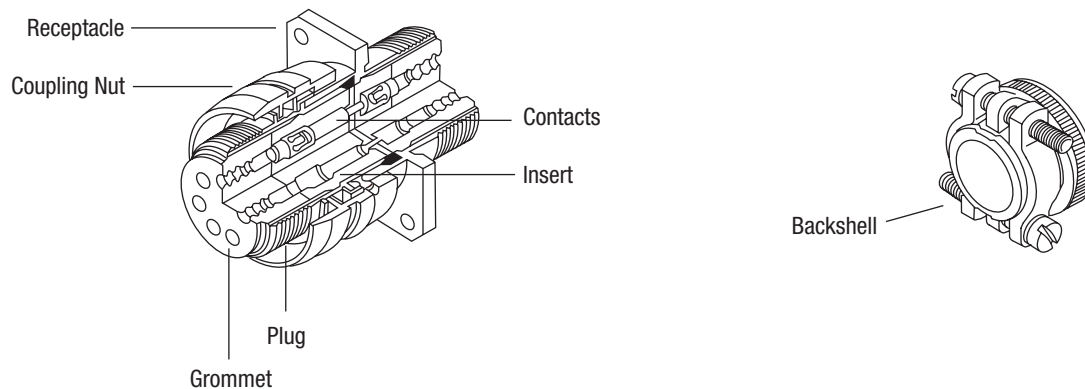

Body Styles:

Coupling: Bayonet

Shell Sizes (typical):

8, 10, 12, 14, 16,
18, 20, 22, 24

Wall Mount Recept.

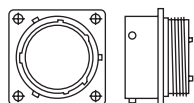

Cable Connecting Recept.

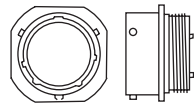

Box Mount Recept.

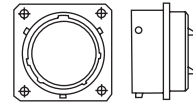

Solder Mount Recept. (Hermetic)

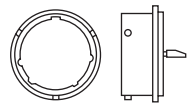

Jam Nut Recept.



Straight Plug

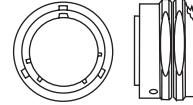

Not in PT

Style Designation (Typical)

Plug	Shell Styles	Plug	Shell Styles	Plug	Shell Styles
06	Straight	00/33	Wall Mount	07	Jam Nut
08	90°	01/44	Cable Connecting		
55	Straight less rear accessory (PT)	02	Box Mount (less rear accessory)		

Dimensions shown in mm (inch)

Specifications and dimensions subject to change

www.ittcannon.com

VEAM PT Connectors

Terminology: Cylindrical Connectors

Inserts

- Solder
 - Crimp
- Metal Clip Retention
Distortable rubber retention

May include a soft front interfacial seal (Bonded) if dielectric is hard, and a rear sealing grommet separate or attached.

Insert (Pin or Socket)

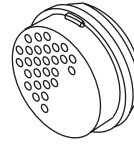

Insert & Grommet Accessory

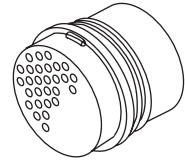

Contacts

Contact sizes:

Contact size	AWG Wire Size
22D Not PT	22-28
22M Not PT	24-28
22 Not PT	22-26
20	20-24
16	16-20
12	12-14
8	8-10
4 Not PT	4-6
0 Not PT	0-2

Pin Crimp*

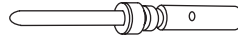

Socket-Crimp*

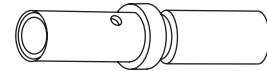

Pin-Solder



Socket-Solder



Size by Wire Gauge

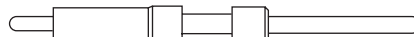
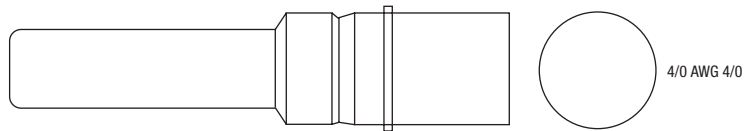

PCB pin contact



PCB socket contact

*Crimps are removable

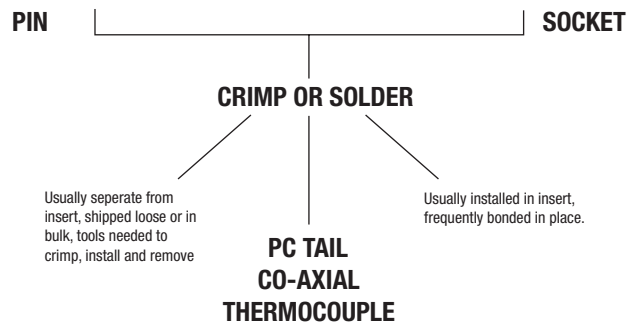

Dimensions shown in mm (inch)
Specifications and dimensions subject to change

www.ittcannon.com

PT/PTSE Connectors

PT Solder Connectors

Part Number Breakdown

Part Number Nomenclature for Solder Connector

To more easily illustrate ordering procedure, part number PT33A20 41PW(SR) is shown as follows:

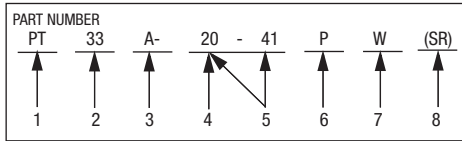

See code below:

1. Connector Families:

PT designates standard olive drab Tri-Lock coupling connector. This is the Veam proprietary version of the MIL-C-26482 solder contact connector B59522F0017 (Pattern 105).

2. Shell Styles:

- "33" designates wall mount receptacle.
- "55" designates cable connecting plug.
- "02" designates box mount receptacle.
- "44" designates in line receptacle.
- "06" designates cable connect plug with accessory
- "07" designates jam nut receptacle.
- "08" designates 90° plug.
- PTB designates thru-bulkhead receptacle.

3. Service Classes:

- "A" designates general duty back shell.
 - "E" designates environmental resisting with grommet and nut.
 - "P" designates potted with potting boot.
 - "W" designates compressing clamp and neoprene gland for moisture-proofing, multi-jacketed cables.
 - "H" designates hermetic seal receptacle.
4. "20" designates shell size. Shell sizes available are 8 through 24.
 5. "20-41" designates insert arrangements.
 6. "P" designates pin contacts. "S" for socket contacts.
 7. "W" designates that insert is rotated in its shell from the standard position to alternate position W. The basic rotations are W, X, Y and Z. No letter required for normal (no rotation) position. The keyways can also be oriented in various positions. The basic rotations are B, C, E and F.
 8. "SR" designates a strain relief clamp. Deviation suffixes would be inserted here. For example: (T01) Ribbed coupling Nut.

Dimensions shown in mm (inch)

Specifications and dimensions subject to change

www.ittcannon.com

PTSE Crimp Connectors

Part Number Breakdown

Proprietary Part Number Construction for Crimp Connectors

To more easily illustrate ordering procedure, part number PT33A20 41PW(SR) is shown as follows:

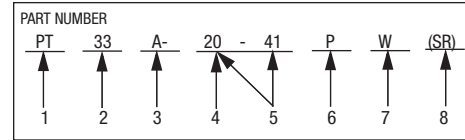

See code below:

1. Connector Families:

PT**SE designates standard olive drab Tri-Lock coupling connector with removable crimp contacts.

2. Shell Styles:

- "33" designates wall mount receptacle.
- "55" designates cable connecting plug.
- "02" designates box mount receptacle.
- "44" designates in line receptacle.
- "06" designates cable connect plug with accessory
- "07" designates jam nut receptacle.
- "08" designates 90° plug.

3. Service Classes:

- "SE" designates environmental crimp. The above are proprietary versions of the MIL-C-26482 crimp contact connector. The contact retention mechanism consists of a metal clip held in place by a nylon wafer.
4. "20" designates shell size. Shell sizes available are 8 through 24.
 5. "20-41" designates insert arrangements.
 6. "P" designates pin contacts. "S" for socket contacts.
 7. "W" designates that insert is rotated in its shell from the standard position to alternate position W. The basic rotations are W, X, Y and Z. No letter required for normal (no rotation) position. The keyways can also be oriented in various positions. The basic rotations are B, C, E and F.
 8. "SR" designates a strain relief clamp. Deviation suffixes would be inserted here. For example: (T01) Ribbed coupling Nut.

VEAM PT Connectors

Contact Arrangements PT, PTSE, CPT & Audio Connectors

CONTACT ARRANGEMENTS												
Contact Arrangements	Voltage Rating	Total Contacts	Contact Size					Plan forms available in the following range:				
			20	16	12	coax	8	PT	PTSE	CPT	AUDIO **	
8-2	1	2	2						•		•	
8-3	1	3	3						•		•	
8-4	1	4	4						•		•	•
8-33	1	3	3						•	•	•	•
8-98	1	3	3						•	•	•	•
10-2	2	2		2					•	□	•	•
10-6	1	6	6						•	•	•	•
10-7	1	7	7						•	□	•	•
SP 10-98	1	6	6						•		•	
SP 10-99	1	7	7						•		•	•
12-3	2	3		3					•	•	•	
SP 12-4	2	4	4	4					□		□	
12-8	1	8	8						•	•	•	
12-10	1	10	10						•	•	•	•
14-2	2	2			2				•	•	•	
14-5	2	5		5					•	•	•	
14-12	1	12	8	4					•	•	•	
14-15	1	15	14	1					•	•	•	
SP 14-18	1	18	18						□	□	□	
14-19	1	19	19						•	•	•	
SP 14-22	1	5	1		4				•	□	•	
SP 14-91	*	3	3						•		•	
16-8	2	8		8					•	•	•	
16-23	1	23	22	1					•	•	•	
16-26	1	26	26						•	•	•	
SP 16-99	1	23	21	2					□	□	□	
18-11	2	11		11					•	•	•	
SP 18-28	1	28	26	2					□	□	□	
SP 18-30	1	30	29	1					□		□	
18-32	1	32	32						•	•	•	
18-50	2	2				2			•		•	
SP 18-80	2	8	6		2				□		□	
SP 18-98	1	8	4		4				□	•	□	
20-16	2	16		16					•	•	•	
SP 20-24	1	24	24						□		□	
SP 20-25	1	25	25						□		□	
SP 20-27	1	27	27						□		□	
20-39	1	39	37	2					□	□	□	
20-41	1	41	41						•	•	•	
SP 22-7	coax	7			7				□	□	□	
SP 22-9	1	9	4		5				•	•	•	
22-21	2	21		21					•	•	•	
SP 22-32	1	32	32						□	□	□	
SP 22-34	1	34	34						□		□	
SP 22-36	1	36	36						□	□	□	
SP 22-41	1	41	27	14					•	•	•	
22-55	1	55	55						•	•	•	
24-61	1	61	61						•	•	•	

KEY

- Preferred ranges
- Non Preferred
- Consult ITT for other arrangements.

VOLTAGE RATING

- 1 2100 dc or ac peak
- 2 3000 dc or ac peak

* 5Kv rms

** See Audio Connectors (pages 00 & 00) for contact arrangements to shell style availability.















SP= Propriety to ITT Corporation



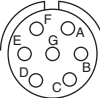

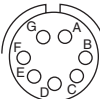
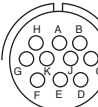
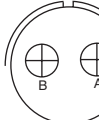
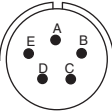

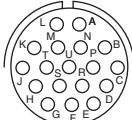
Dimensions shown in mm (inch)
Specifications and dimensions subject to change

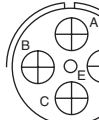
www.ittcannon.com

Contact Arrangements - Preferred Ranges

	8-2 2 X #20 1		8-3 3 X #20 1		8-4 4 X #20 1
	8-33 3 X #20 1		8-98 3 X #20 1		10-2 2 X #16 2
	10-6 6 X #20 1		10-7 7 X #20 1		10-98 6 X #20 1
	10-99 7 X #20 1		12-3 3 X #16 2		12-4 4 X #16 2
	12-8 8 X #20 1		12-10 1 X #20 1		14-2 2 X #12 2
	14-5 5 X #16 2		14-12 8 X #20 4 X #16 1		14-15 14 X #20 4 X #16 1
	14-18 18 X #20 1		14-19 19 X #20 1		14-22 1 X #20 4 X #12 1

CONTACT LEGEND

Contact Arrangement		
Number of Contacts		
Size of Contacts		
Service Rating		
		
8	12	16
		
20	coax	

Dimensions shown in mm (inch)
Specifications and dimensions subject to change

www.ittcannon.com



VEAM PT Connectors

Contact Arrangements - Preferred Ranges

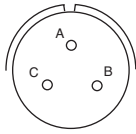

14-91
3 X #20
5 KV ms

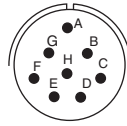

16-8
8 X #16
2

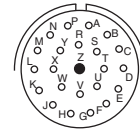

16-23
22 X #20
1 X #16
1

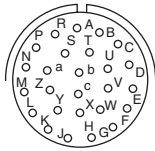

16-26
26 X #20
1

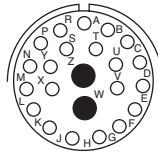

16-99
21 X #20
2 X #16
1

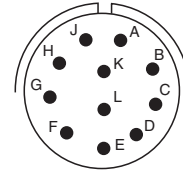

18-11
11 X #16
2

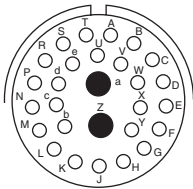

18-28
26 X #20
2 X #16
1

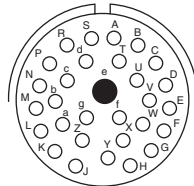

18-30
29 X #20
1 X #16
1

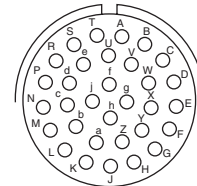

18-32
32 X #20
1

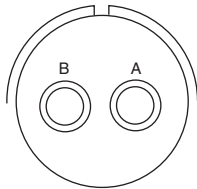

18-50
2 X #8
2

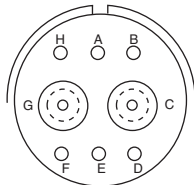

18-80
6 X #20
2 X #8 coax
2

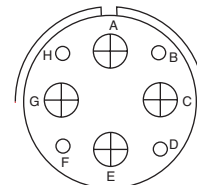

18-98
4 X #20
4 X #12
1

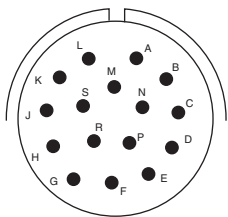

20-16
16 X #16
2

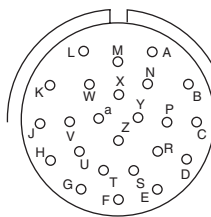

20-24
24 X #20
1

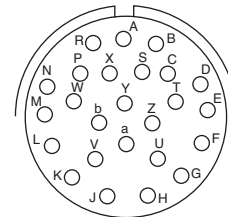

20-25
25 X #20
1



Dimensions shown in mm (inch)
Specifications and dimensions subject to change

www.ittcannon.com

Contact Arrangements - Preferred Ranges

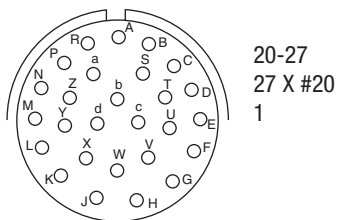

20-27
27 X #20
1

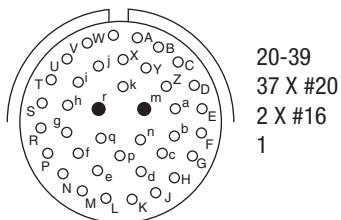

20-39
37 X #20
2 X #16
1

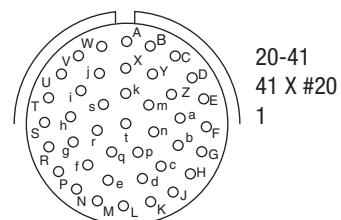

20-41
41 X #20
1

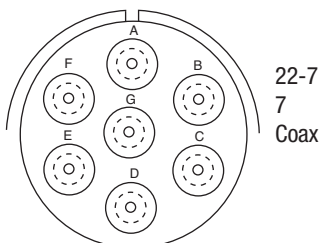

22-7
7
Coax

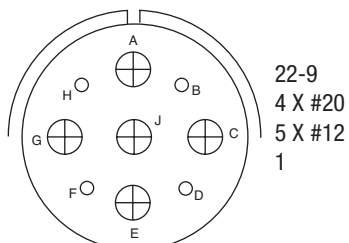

22-9
4 X #20
5 X #12
1

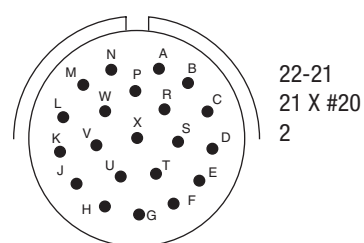

22-21
21 X #20
2

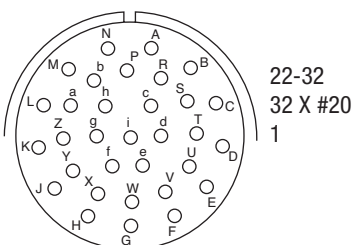

22-32
32 X #20
1

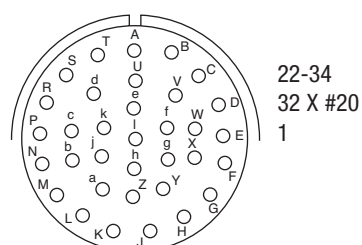

22-34
32 X #20
1

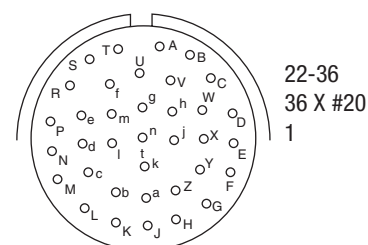

22-36
36 X #20
1

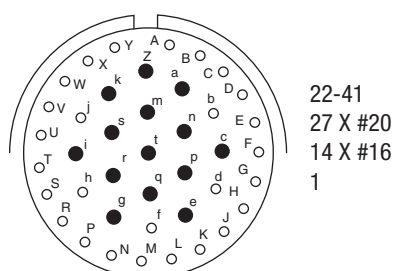

22-41
27 X #20
14 X #16
1

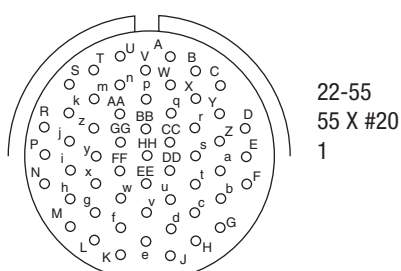

22-55
55 X #20
1

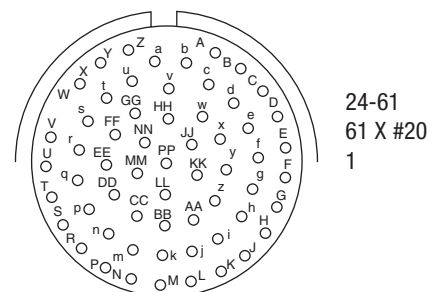

24-61
61 X #20
1

VEAM PT Connectors

Polarization

To avoid cross plugging of similar connectors which may be adjacently mounted, polarization is achieved by shell key/keyways. Up to five alternative positions are available designated N, B, C, E or F. The Diagrams illustrate the angular variation of the keys with the master key being the datum point.

Where no specific polarization is requested, the neutral position N will always be applied.

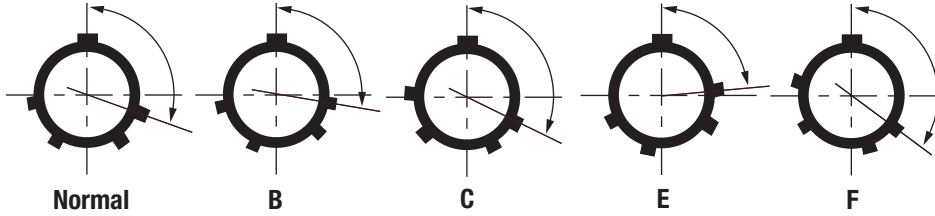

Shell Size	Normal	B	C	E	F
8	105°	-	-	182	82
10	105°	85	125	115	85
12	105°	89	121	115	85
14	105°	91	119	75	120
16	105°	93	117	75	120

Shell Size	Normal	B	C	E	F
18	105°	95	115	75	120
20	105°	95	115	75	120
22	105°	97	113	75	120
24	105°	97	113	75	120

Insert Orientation

The diagrams below illustrates the angular displacement of the insert within the housing, for each orientation in the range. This method is non-preferred and is intended for replacement purposes only.

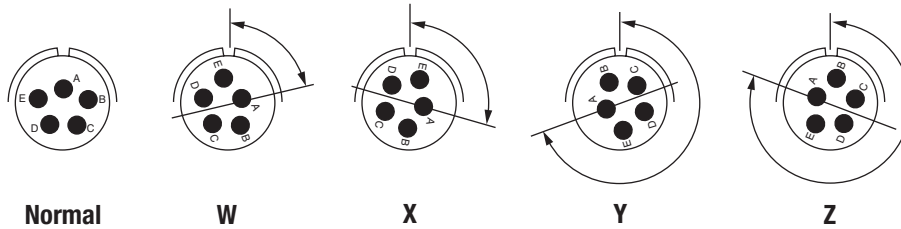

	Availability								
	N	B	C	E	F	W	X	Y	Z
8-2	▲			▲	▲	■	■		
8-3	▲			▲	▲				
8-4	▲			▲	▲	■			
8-33				▲	▲	■			
8-98	▲			▲	▲				
14-2	▲	▲	▲	▲	▲				
14-5	▲	▲	▲	▲	▲	■	■	■	■
14-12	▲	▲	▲	▲	▲	■	■	■	■
14-15	▲	▲	▲	▲	▲	■	■	■	■
14-18	▲	▲	▲	▲	▲				
14-19	▲	▲	▲	▲	▲	■	■	■	
14-22	▲	▲	▲	▲	▲				
14-91	▲	▲	▲	▲	▲				
20-16	▲	▲	▲	▲	▲	■	■	■	■
20-24	▲	▲	▲	▲	▲				
20-25	▲	▲	▲	▲	▲				
20-27	▲	▲	▲	▲	▲				
20-39	▲	▲	▲	▲	▲	■	■	■	■
20-41	▲	▲	▲	▲	▲	■	■	■	

	Availability								
	N	B	C	E	F	W	X	Y	Z
10-2	▲	▲	▲	▲	▲				
10-6	▲	▲	▲	▲	▲	■			
10-7	▲	▲	▲	▲	▲				
10-98	▲	▲	▲	▲	▲				
10-99	▲	▲	▲	▲	▲				
16-8	▲	▲	▲	▲	▲	■	■	■	■
16-23	▲	▲	▲	▲	▲	■	■	■	■
16-26	▲	▲	▲	▲	▲	■	■	■	■
16-99	▲	▲	▲	▲	▲	■	■	■	■
22-7	▲	▲	▲	▲	▲	■	■		
22-9	▲	▲	▲	▲	▲				
22-21	▲	▲	▲	▲	▲	■	■	■	■
22-32	▲	▲	▲	▲	▲				
22-34	▲	▲	▲	▲	▲				
22-36	▲	▲	▲	▲	▲	■	■	■	■
22-41	▲	▲	▲	▲	▲	■	■	■	■
22-55	▲	▲	▲	▲	▲	■	■	■	■

	Availability								
	N	B	C	E	F	W	X	Y	Z
12-3	▲	▲	▲	▲	▲			■	
12-4	▲	▲	▲	▲	▲				
12-8	▲	▲	▲	▲	▲	■	■	■	■
12-10	▲	▲	▲	▲	▲	■	■	■	■
18-11	▲	▲	▲	▲	▲	■	■	■	■
18-28	▲	▲	▲	▲	▲	■	■	■	■
18-30	▲	▲	▲	▲	▲	■	■	■	■
18-32	▲	▲	▲	▲	▲	■	■	■	■
18-50	▲	▲	▲	▲	▲				
18-80	▲	▲	▲	▲	▲	■	■	■	■
18-98	▲	▲	▲	▲	▲				
22-7	▲	▲	▲	▲	▲	■	■	■	■

- ▲ Preferred type
- Not Available
- For replacement purposes only

N.B. Consult factory for availability of
□ contact arrangements not shown



Dimensions shown in mm (inch)
Specifications and dimensions subject to change

www.ittcannon.com

How To Order PT Jam nut connectors

SERIES/ PREFIX	SHELL STYLE	CLASS	SHELL SIZE/ LAYOUT	CONTACT TYPE	polarization	PLATING/ MOD CODE
	NOTE 1	NOTE 1	NOTE 2	NOTE 3	NOTE 4	NOTE 5
PT	07 77	A E SE	(22-55)	S P	(B)	(T69)

How To Order

- 1 Select the shell style and classification eg. PT07E from following pages.
- 2 Add the shell size and contact arrangement eg. PT07E22 55 see pages xxx.
- 3 Add the contacts P=pins, S= sockets eg. PT07E22 55S.
- 4 For polarization add the relevant letter (E, B, C, F) or for orientation add (W, X, Y, Z) from page 14. For normal orientation no letter required.
- 5 Add suffix as required from typical list below.

No Code	Olive drab cadmium plate finish as standard (historically 014)
023	Electroless Nickel plating finish
T69	Zinc Cobalt Olive drab plate finish GB62
T61	Zinc Cobalt Black plate finish (ROHS)
T21	Marine ally Bronze (contact factory)
T62/T65/T66	Pin tail contacts (contact factory)

PT07 Cutout Details

- Formed locking jam nut standard
- Solid locking nut available for size 8/10/12
- Drilled locking nut available at extra cost
- Circular lock nut with slots for size 8 available

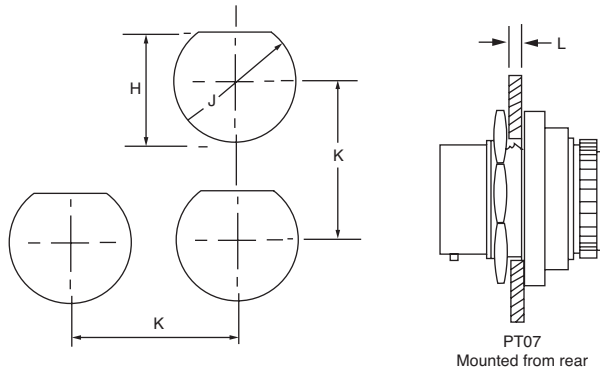

Shell Size	H ±.005	J Dia. ±.005	K Min	L Min.	L Max.
8	.540	.572	.969	.062	.125
10	.665	.697	1.093	.062	.125
12	.828	.885	1.281	.062	.125
14	.952	1.010	1.406	.062	.125
16	1.078	1.135	1.531	.062	.125
18	1.201	1.260	1.656	.062	.125
20	1.326	1.385	1.843	.062	.250
22	1.451	1.510	1.969	.062	.250
24	1.576	1.635	2.093	.062	.250

Dimensions shown in mm (inch)
Specifications and dimensions subject to change

www.ittcannon.com



VEAM PT Connectors

PT07A Jam Nut Receptacle without rear accessory thread (solder contacts)

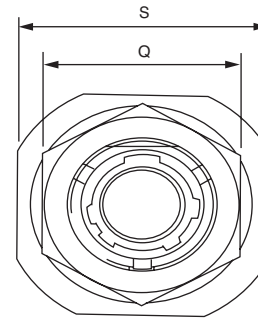
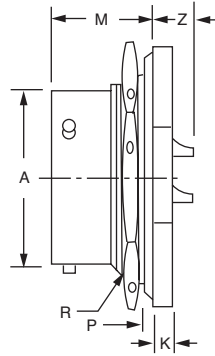

'A' General Duty

Shell size	A diameter	Q diameter	M depth	T length	S diameter	K panel thickness		R jam nut
tolerance	.003 (0.08)	.017 (0.43)	.031 (0.08)	max	max	min	max	thread
8	0.47	0.750	0.696	0.191	0.956	0.06	0.13	.5625-24 UNEF
10	0.59	0.875	0.696	0.191	1.062	0.06	0.13	.6875-24 UNEF
12	0.75	1.062	0.696	0.191	1.250	0.06	0.13	.8750-20 UNEF
14	0.88	1.188	0.696	0.191	1.375	0.06	0.13	1.000-20 UNEF
16	1.00	1.312	0.696	0.191	1.500	0.06	0.13	1.125-18 UNEF
18	1.13	1.458	0.696	0.191	1.625	0.06	0.13	1.250-18 UNEF
20	1.25	1.562	0.884	0.221	1.812	0.06	0.255	1.375-18 UNEF
22	1.38	1.688	0.884	0.221	1.938	0.06	0.255	1.500-18 UNEF
24	1.50	1.812	0.917	0.188	2.062	0.06	0.255	1.625-18 UNEF

PT07E Jam Nut Receptacle with internal rear accessory thread (solder contacts)

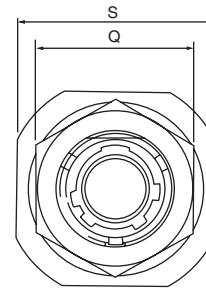
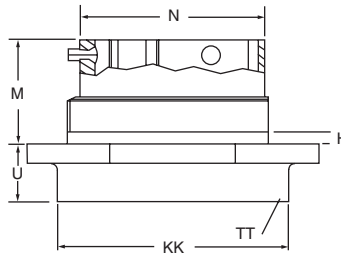

Shell size	N diameter	Q diameter	M depth	T length	S diameter	H panel thickness		G rear diameter	V jam nut
tolerance	.003 (0.08)	.017 (0.43)	.031 (0.08)	max	max	min	max	max	thread
8	0.473	0.750	0.696	0.568	0.956	0.06	0.125	0.729	.5625-24 UNEF
10	0.590	0.875	0.696	0.568	1.062	0.06	0.125	0.854	.6875-24 UNEF
12	0.750	1.062	0.696	0.568	1.250	0.06	0.125	0.979	.8750-20 UNEF
14	0.875	1.188	0.696	0.568	1.375	0.06	0.125	1.104	1.000-20 UNEF
16	1.000	1.312	0.696	0.568	1.500	0.06	0.125	1.229	1.125-18 UNEF
18	1.125	1.458	0.696	0.568	1.625	0.06	0.125	1.354	1.250-18 UNEF
20	1.250	1.562	0.884	0.63	1.812	0.06	0.250	1.510	1.375-18 UNEF
22	1.375	1.688	0.884	0.63	1.938	0.06	0.250	1.635	1.500-18 UNEF
24	1.500	1.812	0.917	0.66	2.062	0.06	0.250	1.760	1.625-18 UNEF



Dimensions shown in mm (inch)
Specifications and dimensions subject to change

www.ittcannon.com

PT77A Jam Nut Receptacle with external rear accessory thread (solder contacts)

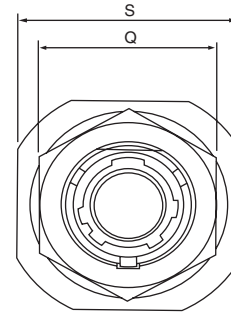
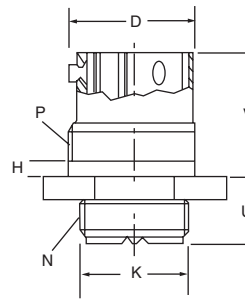

Shell size	D diameter	Q diameter	V depth	U length max	S diameter max	H panel thickness min	H panel thickness max	K rear diameter max	P jam nut thread	N rear access thread
tolerance	.003 (0.08)	.017 (0.43)	.031 (0.08)		max		max	max		
8	0.473	0.750	0.606	0.286	0.956	0.06	0.125	0.436	.5625-24 UNEF	.4375-28 UNEF
10	0.590	0.875	0.606	0.286	1.062	0.06	0.125	0.561	.6875-24 UNEF	.5625-24 UNEF
12	0.750	1.062	0.606	0.286	1.250	0.06	0.125	0.686	.8750-20 UNEF	.6875-24 UNEF
14	0.875	1.188	0.606	0.286	1.375	0.06	0.125	0.811	1.000-20 UNEF	.8125-20 UNEF
16	1.000	1.312	0.606	0.286	1.500	0.06	0.125	0.936	1.125-18 UNEF	.9375-20 UNEF
18	1.125	1.458	0.606	0.286	1.625	0.06	0.125	1.061	1.250-18 UNEF	1.0625-18 UNEF
20	1.250	1.562	0.764	0.306	1.812	0.06	0.250	1.186	1.375-18 UNEF	1.1875-18 UNEF
22	1.375	1.688	0.764	0.306	1.938	0.06	0.250	1.311	1.500-18 UNEF	1.3125-18 UNEF
24	1.500	1.812	0.782	0.306	2.062	0.06	0.250	1.436	1.625-18 UNEF	1.4375-18 UNEF

PT07SE Jam nut Receptacle with internal rear accessory thread (crimp contacts supplied)

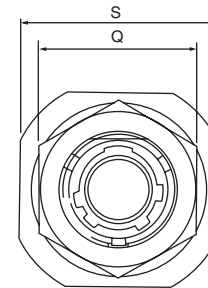
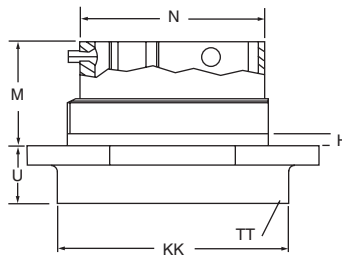

Shell size	N diameter	Q diameter	M depth	U length max	S diameter max	H panel thickness min	H panel thickness max	KK rear diameter max	P jam nut thread	TT rear internal thread
tolerance	.003 (0.08)	.017 (0.43)	.031 (0.08)		max		max	max		
8	0.473	0.750	0.696	0.376	0.956	0.06	0.125	0.719	.5625-24 UNEF	.6250-28 UNEF
10	0.590	0.875	0.696	0.376	1.062	0.06	0.125	0.844	.6875-24 UNEF	.7500-24 UNEF
12	0.750	1.062	0.696	0.376	1.250	0.06	0.125	0.969	.8750-20 UNEF	.8750-24 UNEF
14	0.875	1.188	0.696	0.376	1.375	0.06	0.125	1.094	1.000-20 UNEF	1.000-20 UNEF
16	1.000	1.312	0.696	0.376	1.500	0.06	0.125	1.219	1.125-18 UNEF	1.125-20 UNEF
18	1.125	1.458	0.696	0.376	1.625	0.06	0.125	1.344	1.250-18 UNEF	1.250-18 UNEF
20	1.250	1.562	0.884	0.391	1.812	0.06	0.250	1.500	1.375-18 UNEF	1.375-18 UNEF
22	1.375	1.688	0.884	0.391	1.938	0.06	0.250	1.625	1.500-18 UNEF	1.500-18 UNEF
24	1.500	1.812	0.917	0.411	2.062	0.06	0.250	1.750	1.625-18 UNEF	1.625-18 UNEF

Dimensions shown in mm (inch)
Specifications and dimensions subject to change

www.ittcannon.com



VEAM PT Connectors

PT77SE Jam Nut Receptacle with external rear accessory thread (crimp contacts supplied loose)

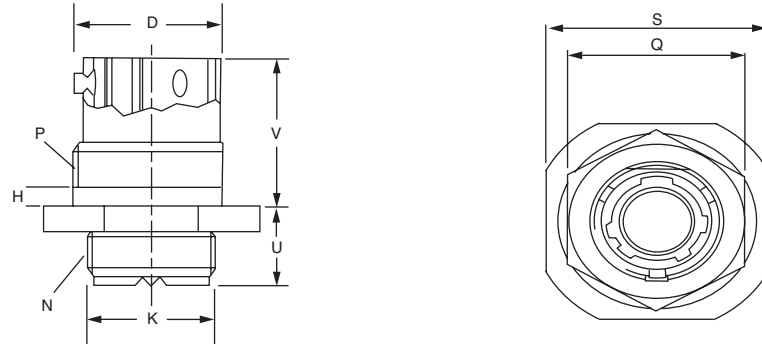

Shell size	D diameter tolerance .003 (0.08)	Q diameter tolerance .017 (0.43)	V depth tolerance .031 (0.08)	U length max	S diameter max	H panel thickness min	H panel thickness max	K rear diameter max	P jam nut thread	N rear access thread
8	0.473	0.750	0.636	0.255	0.956	0.06	0.125	0.436	.5625-24 UNEF	.4375-28 UNEF
10	0.590	0.875	0.636	0.255	1.062	0.06	0.125	0.561	.6875-24 UNEF	.5625-24 UNEF
12	0.750	1.062	0.636	0.255	1.250	0.06	0.125	0.686	.8750-20 UNEF	.6875-24 UNEF
14	0.875	1.188	0.636	0.255	1.375	0.06	0.125	0.811	1.000-20 UNEF	.8125-20 UNEF
16	1.000	1.312	0.636	0.255	1.500	0.06	0.125	0.936	1.125-18 UNEF	.9375-20 UNEF
18	1.125	1.458	0.636	0.255	1.625	0.06	0.125	1.061	1.250-18 UNEF	1.0625-18 UNEF
20	1.250	1.562	0.794	0.275	1.812	0.06	0.250	1.186	1.375-18 UNEF	1.1875-18 UNEF
22	1.375	1.688	0.794	0.275	1.938	0.06	0.250	1.311	1.500-18 UNEF	1.3125-18 UNEF
24	1.500	1.812	0.812	0.275	2.062	0.06	0.250	1.436	1.625-18 UNEF	1.4375-18 UNEF

PT Jam Nut Accessories

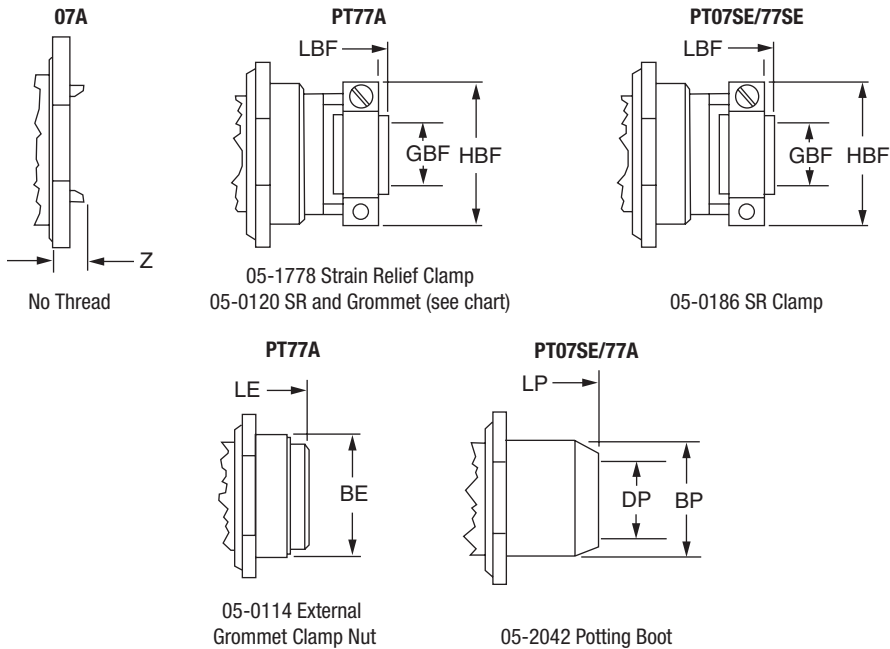

For dimensional data see accessories section on page's 33 to 39.

Protective caps are located on page 33.

For connector supplied complete with relevant accessory please use cross reference chart on page 42 or consult factory.



Dimensions shown in mm (inch)
Specifications and dimensions subject to change

www.ittcannon.com

How to order Panel Mount Connectors

SERIES/ PREFIX	SHELL STYLE	CLASS	SHELL SIZE/ LAYOUT	CONTACT TYPE	polarization	PLATING/ MOD CODE
	NOTE 1	NOTE 1	NOTE 2	NOTE 3	NOTE 4	NOTE 5
PT	02		(22-55)	S	(B)	(T69)
	33	A		P		
	44	SE				
	B					
	00	obsolete				

How To Order

- 1 Select the shell style and classification eg. PT02A from following pages.
- 2 Add the shell size and contact arrangement eg. PT02A22 55 see pages xxx.
- 3 Add the contacts P=pins, S= sockets eg. PT02A22 55S.
- 4 For polarization add the relevant letter (E, B, C, F) or for orientation add (W, X, Y, Z) from page 14. For normal orientation no letter required.
- 5 Add suffix as required from typical list below.

No Code	Olive drab cadmium plate finish as standard (historically 014)
023	Electroless Nickel plating finish
T69	Zinc Cobalt Olive drab plate finish GB62
T61	Zinc Cobalt Black plate finish (ROHS)
T21	Marine ally Bronze (contact factory)
T62/T65/T66	Pin tail contacts (contact factory)

Panel Mount Cut-Out Details

Front Mount

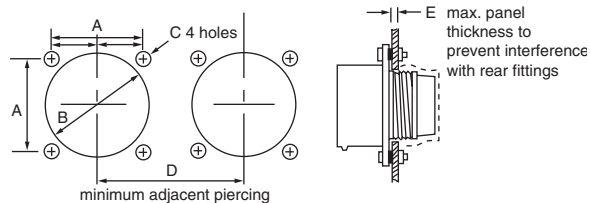

Shell Size	A	B Dia. +.000 -.010	C Dia. +.004 -.002	D	E
	t.p.			Min.	Max.
8	.594	.458	.120	.843	.100
10	.719	.583	.120	.969	.100
12	.812	.708	.120	1.062	.100
14	.906	.833	.120	1.156	.100
16	.969	.958	.120	1.250	.100
18	1.062	1.083	.120	1.343	.100
20	1.156	1.208	.120	1.469	.160
22	1.250	1.333	.120	1.593	.160
24	1.375	1.458	.147	1.718	.100

Rear Mount

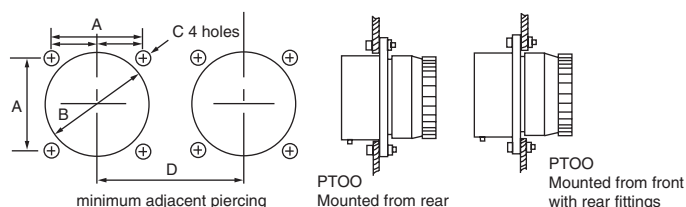

Shell Size	A	C Dia. +.004 -.002	D	F Dia. +.000 -.010	E
	t.p.		Min.		Max.
8	.594	.120	.843	.580	.100
10	.719	.120	.969	.700	.100
12	.812	.120	1.062	.859	.100
14	.906	.120	1.156	.983	.100
16	.969	.120	1.250	1.108	.100
18	1.062	.120	1.343	1.233	.100
20	1.156	.120	1.469	1.359	.230
22	1.250	.120	1.593	1.493	.230
24	1.375	.147	1.718	1.614	.230

Dimensions shown in mm (inch)
Specifications and dimensions subject to change

www.ittcannon.com



VEAM PT Connectors

PT02 Box Mount Receptacle without rear accessory thread (solder contacts)

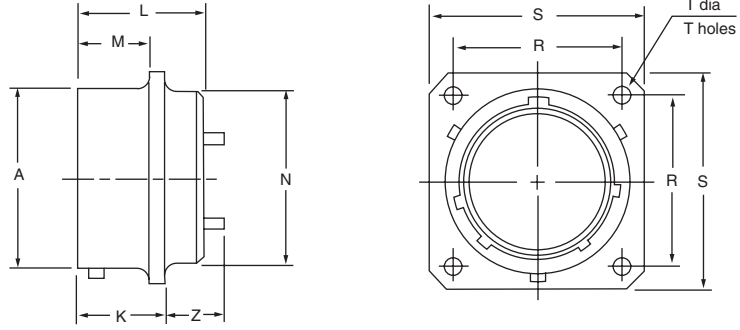

Shell size	A diameter	M length	L depth	N rear diameter	R hole space	S width	T hole diameter
tolerance	.003 (0.08)	0.01	0.825	0.01		0.016	0.005
8	0.473	0.431	0.825	0.449	0.594	0.812	0.120
10	0.590	0.431	0.825	0.573	0.719	0.938	0.120
12	0.750	0.431	0.825	0.699	0.812	1.031	0.120
14	0.875	0.431	0.825	0.823	0.906	1.125	0.120
16	1.000	0.431	0.825	0.949	0.969	1.219	0.120
18	1.125	0.431	0.825	1.073	1.062	1.312	0.120
20	1.250	0.556	1.076	1.199	1.156	1.438	0.120
22	1.375	0.556	1.076	1.323	1.250	1.562	0.120
24	1.500	0.589	1.109	1.449	1.375	1.688	0.147

PT33A Wall Mount Receptacle with external rear accessory thread (solder contacts)

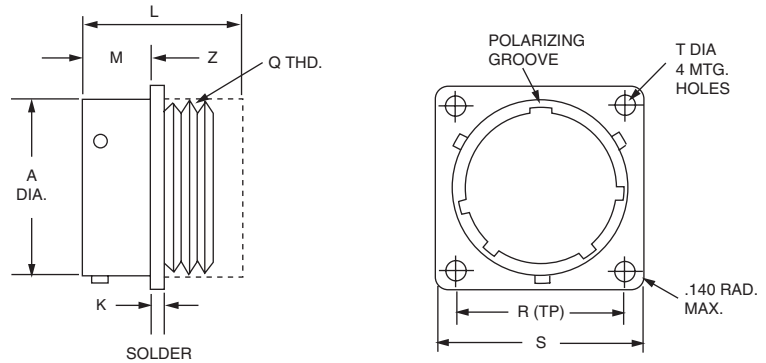

Shell size	A diameter	M length	L depth	K thickness	Z length	KK rear diameter	R hole space	S width	Q thread
tolerance	.003 (0.08)	0.01	0.020	0.01	0.04	0.01			
8	0.473	0.431	0.887	0.062	0.594	0.438	0.594	0.812	.4375-28 UNEF
10	0.590	0.431	0.887	0.062	0.394	0.562	0.719	0.938	.5625-24 UNEF
12	0.750	0.431	0.887	0.062	0.394	0.688	0.812	1.031	.6875-24 UNEF
14	0.875	0.431	0.887	0.062	0.394	0.812	0.906	1.125	.8125-20 UNEF
16	1.000	0.431	0.887	0.062	0.394	0.938	0.969	1.219	.9375-20 UNEF
18	1.125	0.431	0.887	0.062	0.394	1.062	1.062	1.312	1.0625-18 UNEF
20	1.250	0.556	1.105	0.094	0.455	1.188	1.156	1.438	1.1875-18 UNEF
22	1.375	0.556	1.105	0.094	0.455	1.312	1.250	1.562	1.3125-18 UNEF
24	1.500	0.589	1.105	0.094	0.422	1.438	1.375	1.688	1.4375-18 UNEF



Dimensions shown in mm (inch)
Specifications and dimensions subject to change

www.ittcannon.com

PT02SE Box Mount Receptacle without rear accessory thread (crimp contacts)

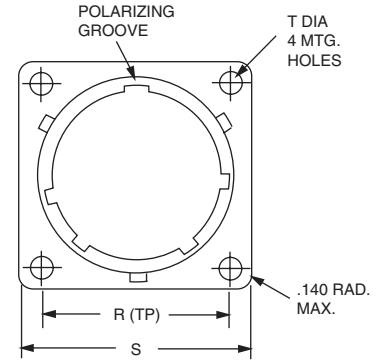
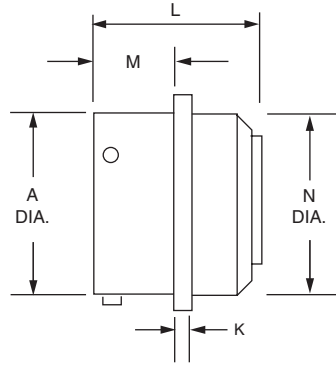

Shell size	A diameter	M length	L depth	K thickness	Z length	N rear diameter	R hole space	S width
tolerance	.003 (0.08)	0.01	0.020	0.01	0.04	0.01		
8	0.473	0.431	0.825	0.062	0.594	0.469	0.594	0.828
10	0.590	0.431	0.825	0.062	0.394	0.593	0.719	0.954
12	0.750	0.431	0.825	0.062	0.394	0.719	0.812	1.047
14	0.875	0.431	0.825	0.062	0.394	0.843	0.906	1.141
16	1.000	0.431	0.825	0.062	0.394	0.969	0.969	1.234
18	1.125	0.431	0.825	0.062	0.394	1.093	1.062	1.328
20	1.250	0.556	1.011	0.094	0.455	1.219	1.156	1.453
22	1.375	0.556	1.011	0.094	0.455	1.343	1.250	1.578
24	1.500	0.589	1.011	0.094	0.422	1.469	1.375	1.702

PT33SE Receptacle with external rear accessory thread (crimp contacts supplied)

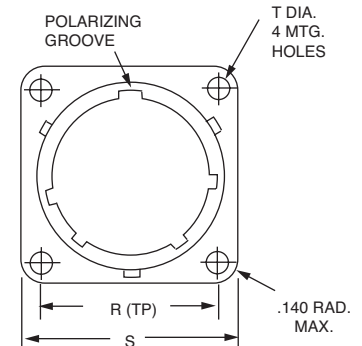
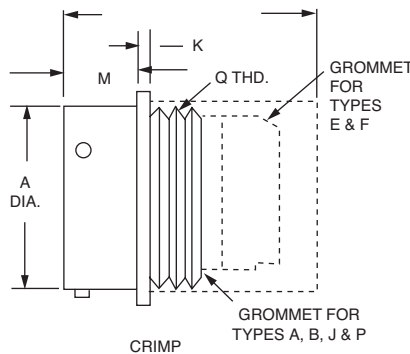

shell size	A diameter	M length	Z length	N rear diameter	Q thread	S width	R hole space
tolerance	.003 (0.08)	0.016	0.04	0.01			
8	0.473	0.431	0.948	0.469	.4375-28 UNEF	0.828	0.594
10	0.590	0.431	0.948	0.593	.5625-24 UNEF	0.954	0.719
12	0.750	0.431	0.948	0.719	.6875-24 UNEF	1.047	0.812
14	0.875	0.431	0.948	0.843	.8125-20 UNEF	1.141	0.906
16	1.000	0.431	0.948	0.969	.9375-20 UNEF	1.234	0.969
18	1.125	0.431	0.948	1.093	1.0625-18 UNEF	1.328	1.062
20	1.250	0.556	1.166	1.219	1.1875-18 UNEF	1.453	1.156
22	1.375	0.556	1.166	1.343	1.3125-18 UNEF	1.578	1.250
24	1.500	0.589	1.166	1.469	1.4375-18 UNEF	1.703	1.375

Dimensions shown in mm (inch)
 Specifications and dimensions subject to change

www.ittcannon.com



VEAM PT Connectors

PT44A Line Connecting Receptacle (no fixing holes) with rear accessory thread solder contacts

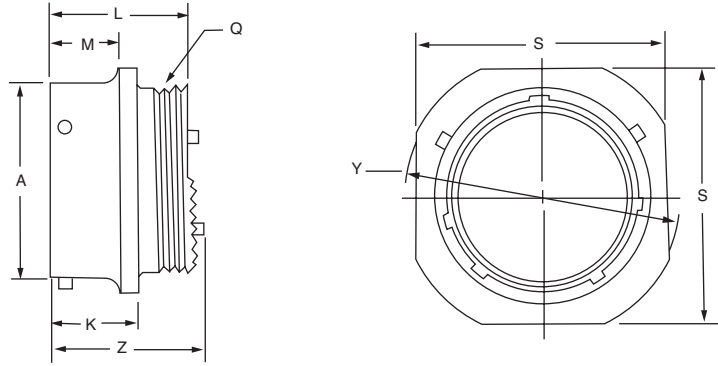

Shell size	A diameter	M length	Y diameter	Z length	N rear diameter	Q thread	S width
tolerance	.003 (0.08)	0.016	0.02	0.04	0.01		
8	0.473	0.400	0.938	0.948	0.469	.4375-28 UNEF	0.812
10	0.590	0.400	1.062	0.948	0.593	.5625-24 UNEF	0.938
12	0.750	0.400	1.156	0.948	0.719	.6875-24 UNEF	1.031
14	0.875	0.400	1.25	0.948	0.843	.8125-20 UNEF	1.125
16	1.000	0.400	1.344	0.948	0.969	.9375-20 UNEF	1.219
18	1.125	0.400	1.438	0.948	1.093	1.0625-18 UNEF	1.312
20	1.250	0.535	1.562	1.166	1.219	1.1875-18 UNEF	1.438
22	1.375	0.535	1.688	1.166	1.343	1.3125-18 UNEF	1.562
24	1.500	0.568	1.812	1.166	1.469	1.4375-18 UNEF	1.688

PT44SE Line Connecting Receptacle (no fixing holes) with rear accessory thread (crimp contacts supplied)

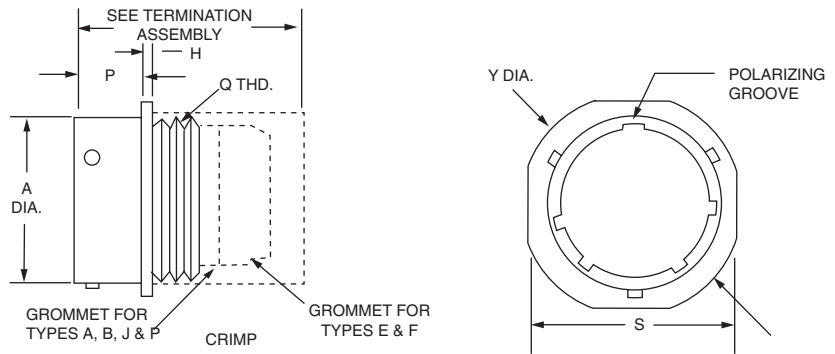

Shell size	A diameter	P length	H panel thickness	S width	Y diameter	Q thread
tolerance	.003 (0.08)	0.031	0.094			
8	0.473	0.400	0.094	0.828	0.958	.4375-28 UNEF
10	0.590	0.400	0.094	0.954	1.082	.5625-24 UNEF
12	0.750	0.400	0.094	1.047	1.176	.6875-24 UNEF
14	0.875	0.400	0.094	1.141	1.270	.8125-20 UNEF
16	1.000	0.400	0.094	1.234	1.364	.9375-20 UNEF
18	1.125	0.400	0.094	1.328	1.458	1.0625-18 UNEF
20	1.250	0.535	0.115	1.453	1.582	1.1875-18 UNEF
22	1.375	0.535	0.115	1.578	1.708	1.3125-18 UNEF
24	1.500	0.535	0.115	1.703	1.832	1.4375-18 UNEF



Dimensions shown in mm (inch)
Specifications and dimensions subject to change

www.ittcannon.com

PTB Thru Bulkhead Connector

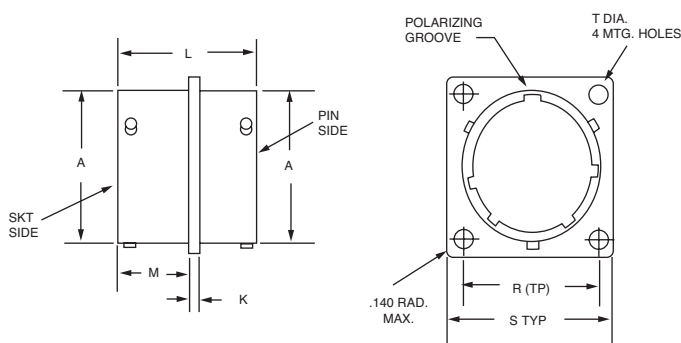

shell size	A diameter	M length	L	S width	R hole space	K panel thickness
tolerance	.003 (0.08)	0.031	1.125			0.016
8	0.473	0.562	1.125	0.828	0.594	0.062
10	0.590	0.562	1.125	0.954	0.719	0.062
12	0.750	0.562	1.125	1.047	0.812	0.062
14	0.875	0.562	1.125	1.141	0.906	0.062
16	1.000	0.562	1.125	1.234	0.969	0.062
18	1.125	0.562	1.125	1.328	1.062	0.062
20	1.250	0.688	1.406	1.453	1.156	0.094
22	1.375	0.688	1.406	1.578	1.250	0.094
24	1.500	0.688	1.406	1.703	1.375	0.009

This connector is a thru-bulkhead version with double faced non-removable pin and socket insert construction allowing mating from both ends for applications requiring the disconnection of a power source from either side of a panel, or where air leakage requirements are critical.

Dummy Stowage Connector 05-0167-XX

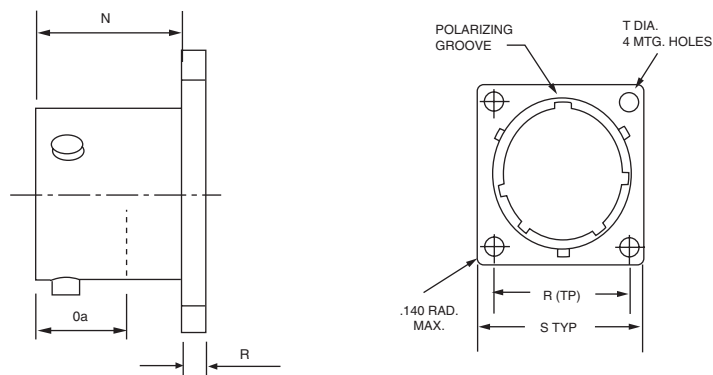

To complete receptacle part number replace xx with shell size and add plating mod code from "How to Order" section on page 19.

Size	Diameter	N Depth	Oa Mating	R Thickness
8	0.473	0.493	0.300	0.080
10	0.590	0.493	0.300	0.080
12	0.750	0.493	0.300	0.080
14	0.875	0.493	0.300	0.080
16	1.000	0.493	0.300	0.080
18	1.125	0.493	0.300	0.080
20	1.250	0.587	0.360	0.110
22	1.375	0.587	0.360	0.110
24	1.500	0.620	0.360	0.110

VEAM PT Connectors

Flange Mount Gaskets 05-0368-xx

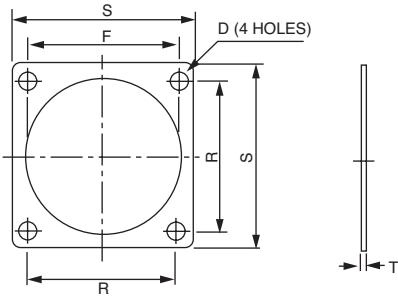

Size	Hole Diameter D	Hole to Hole R	Width S	Thick T
8	0.13	0.594	0.812	0.031
10	0.13	0.719	0.958	0.031
12	0.13	0.813	1.031	0.031
14	0.13	0.906	1.123	0.031
16	0.13	0.969	1.219	0.031
18	0.13	1.065	1.312	0.031
20	0.13	1.156	1.438	0.031
22	0.13	1.250	1.565	0.031
24	0.13	1.373	1.658	0.031

PT Panel Mount Accessories

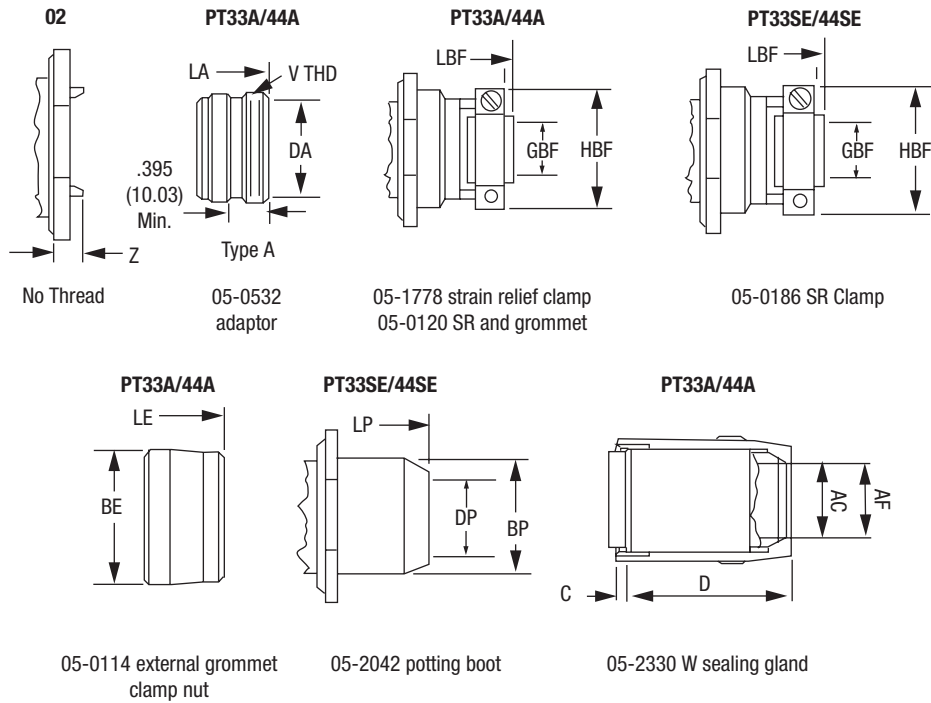

For dimensional data see accessories section on page's 33 to 39

Protective caps are located on page 33.

For connector supplied complete with relevant accessory please use cross reference chart on page 42 or consult factory



Dimensions shown in mm (inch)
Specifications and dimensions subject to change

www.ittcannon.com

How To Order PT Plug Connectors

PT plugs can be supplied with or without grounding springs, designated by G in part number.
Heavy ribbed (Arctic) coupling nuts are specified by adding T01 in mod code.

SERIES/ PREFIX	SHELL STYLE	CLASS	SHELL SIZE/ LAYOUT	CONTACT TYPE	polarization	PLATING/ MOD CODE
	NOTE 1	NOTE 1	NOTE 2	NOTE 3	NOTE 4	NOTE 5
PT	55	A	(22-55)	S	(B)	(T69)
PTG		SE		P		

How To Order

1 Select the shell style and classification eg. PT55A from following pages.

2 Add the shell size and contact arrangement eg. PT55A22 55 see pages xxx.

3 Add the contacts P=pins, S= sockets eg. PT55A22 55S.

4 For polarization add the relevant letter (E, B, C, F) or for orientation add (W, X, Y, Z) from page 14. For normal orientation no letter required.

5 Add suffix as required from typical list below.

No Code	Olive drab cadmium plate finish as standard (historically014)
23	Electroless Nickel plating finish
SR	Strain Relief
T01	Ribbed coupling nut
T02	Ribbed coupling nut and strain relief
T21	Marine ally Bronze (contact factory)
T62/T65/T66	Pin tail contacts (contact factory)
T69	Zinc cobalt olive drab plate finish

VEAM PT Connectors

PT55A Straight Plug with Solder Contacts

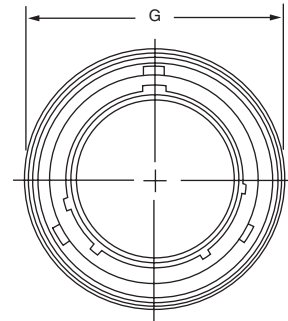
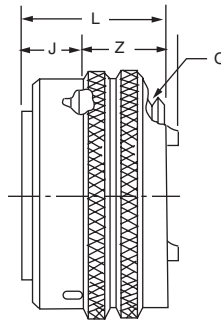

Shell Size	G diameter	J mate	Z depth	L body	Q thread
tolerance	.003 (0.08)	0.01			
8	.765	0.353	0.594	0.906	.4375-28 UNEF
10	.840	0.353	0.594	0.906	.5625-24 UNEF
12	.999	0.353	0.594	0.906	.6875-24 UNEF
14	1.139	0.353	0.594	0.906	.8125-20 UNEF
16	1.261	0.353	0.594	0.906	.9375-20 UNEF
18	1.337	0.353	0.594	0.906	1.0625-18 UNEF
20	1.477	0.415	0.672	1.062	1.1875-18 UNEF
22	1.602	0.415	0.672	1.062	1.3125-18 UNEF
24	1.723	0.415	0.672	1.125	1.4375-18 UNEF

PTG55A Straight Plug with Grounding Spring and Solder Contacts

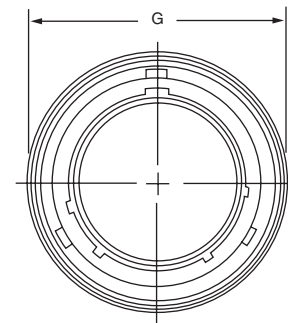
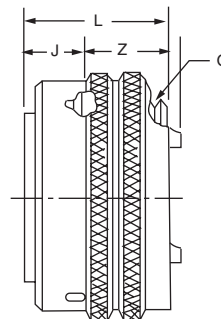

Shell Size	G diameter	J mate	Z depth	L body	Q thread
tolerance	.003 (0.08)	0.01			
8	.765	0.353	0.594	0.906	.4375-28 UNEF
10	.840	0.353	0.594	0.906	.5625-24 UNEF
12	.999	0.353	0.594	0.906	.6875-24 UNEF
14	1.139	0.353	0.594	0.906	.8125-20 UNEF
16	1.261	0.353	0.594	0.906	.9375-20 UNEF
18	1.337	0.353	0.594	0.906	1.0625-18 UNEF
20	1.477	0.415	0.672	1.062	1.1875-18 UNEF
22	1.602	0.415	0.672	1.062	1.3125-18 UNEF
24	1.723	0.415	0.672	1.125	1.4375-18 UNEF



Dimensions shown in mm (inch)
Specifications and dimensions subject to change

www.ittcannon.com

PT55SE Straight Plug with Crimp Contacts

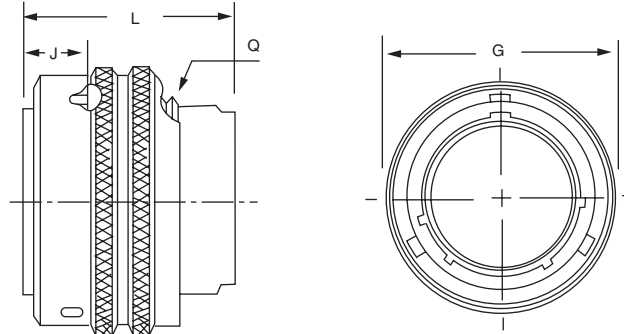

Shell Size	G diameter	J mate	L depth	Q thread
tolerance	.003 (0.08)	0.01		
8	.765	0.353	1.900	.4375-28 UNEF
10	.859	0.353	1.900	.5625-24 UNEF
12	1.031	0.353	1.900	.6875-24 UNEF
14	1.156	0.353	1.900	.8125-20 UNEF
16	1.281	0.353	1.987	.9375-20 UNEF
18	1.391	0.353	1.987	1.0625-18 UNEF
20	1.531	0.415	2.087	1.1875-18 UNEF
22	1.656	0.415	2.087	1.3125-18 UNEF
24	1.776	0.415	2.149	1.4375-18 UNEF

PTG55SE Straight Plug with Grounding Fingers and Crimp Contacts

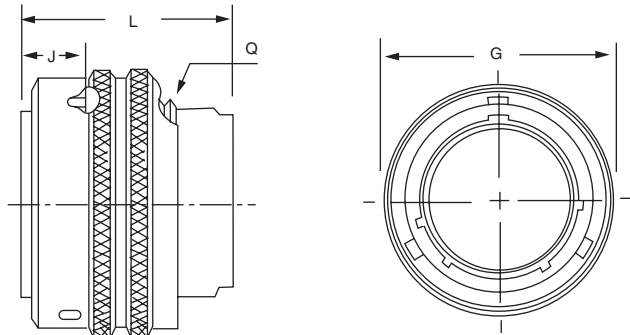

Shell Size	G diameter	J mate	L depth	Q thread
tolerance	.003 (0.08)	0.01		
8	.765	0.353	1.900	.4375-28 UNEF
10	.859	0.353	1.900	.5625-24 UNEF
12	1.031	0.353	1.900	.6875-24 UNEF
14	1.156	0.353	1.900	.8125-20 UNEF
16	1.281	0.353	1.987	.9375-20 UNEF
18	1.391	0.353	1.987	1.0625-18 UNEF
20	1.531	0.415	2.087	1.1875-18 UNEF
22	1.656	0.415	2.087	1.3125-18 UNEF
24	1.776	0.415	2.149	1.4375-18 UNEF

Dimensions shown in mm (inch)
Specifications and dimensions subject to change

www.ittcannon.com

VEAM PT Connectors

PT55A (T01) Straight Plug with Ribbed Coupling Nut and Solder Contacts

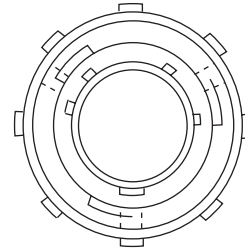
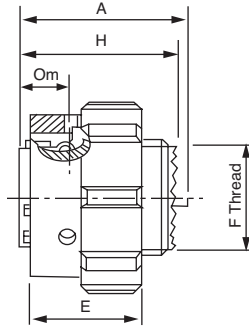

Shell Size	B diameter	D coupling nut dia	Om mate	H depth	F thread
tolerance	.003 (0.08)	0.038	0.01		
8	0.64	0.825	0.301	0.906	.4375-28 UNEF
10	0.756	0.937	0.301	0.906	.5625-24 UNEF
12	0.940	1.109	0.301	0.906	.6875-24 UNEF
14	1.063	1.234	0.301	0.906	.8125-20 UNEF
16	1.197	1.437	0.301	0.906	.9375-20 UNEF
18	1.308	1.548	0.301	0.906	1.0625-18 UNEF
20	1.430	1.67	0.301	1.062	1.1875-18 UNEF
22	1.565	1.78	0.341	1.062	1.3125-18 UNEF
24	1.678	1.905	0.341	1.125	1.4375-18 UNEF

PTG55A (T01) Straight Plug with Grounding Spring/Ribbed Coupling Nut and Solder Contacts

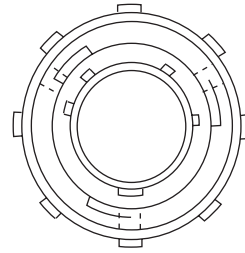
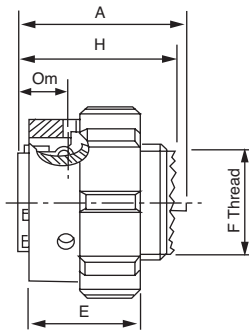

Shell Size	B diameter	D coupling nut dia	Om mate	H depth	F thread
tolerance	.003 (0.08)	0.038	0.01		
8	0.64	0.825	0.301	0.906	.4375-28 UNEF
10	0.756	0.937	0.301	0.906	.5625-24 UNEF
12	0.940	1.109	0.301	0.906	.6875-24 UNEF
14	1.063	1.234	0.301	0.906	.8125-20 UNEF
16	1.197	1.437	0.301	0.906	.9375-20 UNEF
18	1.308	1.548	0.301	0.906	1.0625-18 UNEF
20	1.430	1.67	0.301	1.062	1.1875-18 UNEF
22	1.565	1.78	0.341	1.062	1.3125-18 UNEF
24	1.678	1.905	0.341	1.125	1.4375-18 UNEF



Dimensions shown in mm (inch)
Specifications and dimensions subject to change

www.ittcannon.com

PT55SE (T01) Straight Plug with Grounding Fingers/Ribbed Coupling Nut and Crimp Contacts

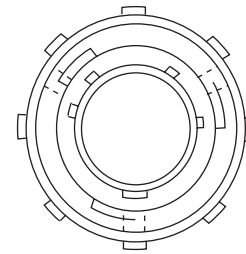
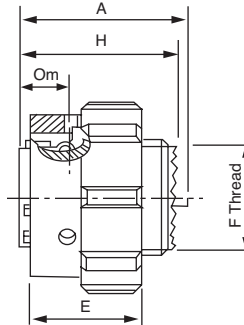

Shell Size	B diameter	D coupling nut dia	Om mate	H depth	F thread
tolerance	.003 (0.08)	0.038	0.01		
8	0.765	0.825	0.353	1.900	.4375-28 UNEF
10	0.859	0.937	0.353	1.900	.5625-24 UNEF
12	1.031	1.109	0.353	1.900	.6875-24 UNEF
14	1.156	1.234	0.353	1.900	.8125-20 UNEF
16	1.281	1.437	0.353	1.978	.9375-20 UNEF
18	1.391	1.548	0.353	1.978	1.0625-18 UNEF
20	1.531	1.67	0.415	2.087	1.1875-18 UNEF
22	1.656	1.78	0.415	2.087	1.3125-18 UNEF
24	1.776	1.905	0.415	2.149	1.4375-18 UNEF

PTG55SE (T01) Straight Plug with Grounding Fingers/Ribbed Coupling Nut and Crimp Contacts

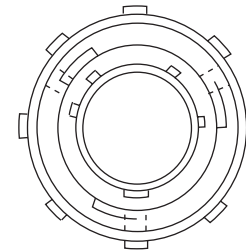
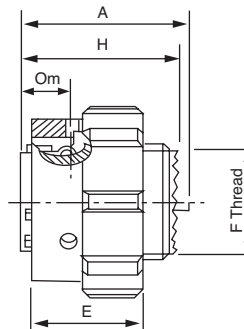

Shell Size	B diameter	D coupling nut dia	Om mate	H depth	F thread
tolerance	.003 (0.08)	0.038	0.01		
8	0.765	0.825	0.353	1.900	.4375-28 UNEF
10	0.859	0.937	0.353	1.900	.5625-24 UNEF
12	1.031	1.109	0.353	1.900	.6875-24 UNEF
14	1.156	1.234	0.353	1.900	.8125-20 UNEF
16	1.281	1.437	0.353	1.978	.9375-20 UNEF
18	1.391	1.548	0.353	1.978	1.0625-18 UNEF
20	1.531	1.67	0.415	2.087	1.1875-18 UNEF
22	1.656	1.78	0.415	2.087	1.3125-18 UNEF
24	1.776	1.905	0.415	2.149	1.4375-18 UNEF

Dimensions shown in mm (inch)
Specifications and dimensions subject to change

www.ittcannon.com

VEAM PT Connectors

PT Plug Accessories

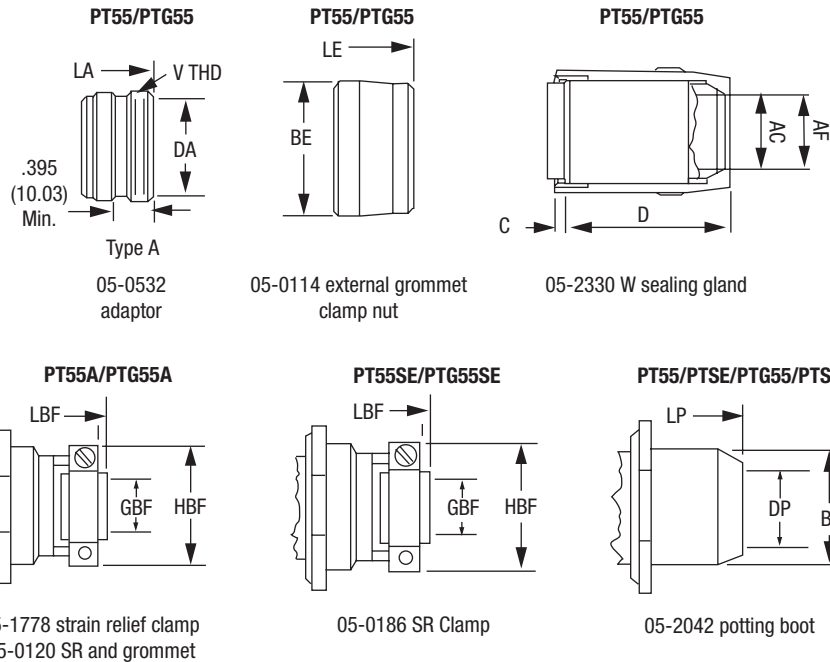

For dimensional data see accessories section on page's 33 to 39.

For connector supplied complete with relevant accessory please use cross reference chart on page 42 or consult factory.

Strain relief clamps are not supplied with cable clamp grommet, which should be ordered separately from data on page 33.

Protective caps are located on page 33.

CPT Connectors

- The CPT range is a proprietary design and is a commercial version of the PTSE crimp contact connectors, available in shell sizes 8 to 18.
- They are interchangeable and interchangeable with PT and PTSE ranges and offer similar mechanical and electrical performance.
- Since they use standard PT hardware they are dimensionally similar to that range, and all relevant dimensions can be obtained from that section of this catalog.
- CPT connectors can be supplied with or without contacts. Details of CPT contacts can be found in the "contacts" section of this catalog.

Available CPT variants in shell sizes 8 thru 18

- CPT77A jam nut receptacle with external rear accessory thread (crimp contacts)
- CPT07E jam nut receptacle with internal rear accessory thread (crimp contacts)
- CPT02 mount receptacle with without rear accessory thread (crimp contacts)
- CPT33A wall mount receptacle with external rear accessory thread (crimp contacts)
- CPT44A line connecting receptacle (no fixing holes) with rear accessory thread (crimp contacts)
- CPT55A straight plug with standard coupling nut (crimp contacts)
- CPT55AT01 straight plug with ribbed coupling nut (crimp contacts)
- CPTG55A straight plug with standard coupling nut/grounding spring (crimp contacts)
- CPTG55AT01 straight plug with ribbed coupling nut/grounding spring (crimp contacts)



Dimensions shown in mm (inch)
Specifications and dimensions subject to change

www.ittcannon.com

Crimp Contacts Insertion & Removal

Insertion

Remove the connector rear accessories that may be fitted and thread them on to the cables. Locate wire and crimped contact in the tool, insert the contact in to the relevant contact cavity from the rear. Maintain alignment with the axis of the connector until the contact is located in the correct position. With PTSE connectors a slight click may be heard as the positive stop is felt. All contacts must be fitted and sealing plugs used behind any contacts that are not wired.

Removal

Remove the connector back fittings. Align the tool over the front of the contact and maintain gentle pressure on the tool while pushing forward to eject the contact. With PTSE range the tip of the tool must locate in the contact retention device. Do not attempt to tilt or rotate the tool within the connector.

Contacts	Insertion	Extraction Tool	Crimp Tool	Locator
20 PTSE	05-2231-20	05-2230-20	M22520/1-01	M22520/1-02
20 PTSE	05-0407-20	05-2230-20	M22520/1-01	M22520/1-02
16 PTSE	05-2231-20	05-2230-16	M22520/1-01	M22520/1-02
16 PTSE	05-2231-20	05-2230-20	M22520/1-01	M22520/1-02
20&20/22CPT	05-0484-20	05-0485-20	11-7295	05-0026
16CPT	05-2231-16	05-2230-16	11-7295	Supplied with tool

Insertion Tools



A43240
Removal Kit



Crimp Tool



VEAM PT Connectors

Contacts, Tools & Assembly (PTSE, CPT)

PTSE CONTACTS		SEALING PLUGS		
size	Part Number	Part Number	Color	Wires Awg
20	Pin 05-1124 Socket 05-2376	05-2661-A20	red	24, 22 & 20
20	Pin 05-1127 Socket 05-1128	05-2661-A20	red	24, 22 & 20
16	Pin 05-1130 Socket 05-1131	05-2661-16	blue	18 & 16
12	Pin 05-1133 Socket 05-1134	05-2661-12	yellow	14 & 12

CPT CONTACTS			SEALING PLUGS		
size	Part Number	Shell Size	Part Number	Color	Wires Awg
20	Pin 05-1136 Socket 05-1138	8-18	05-2661-A20	red	24, 22 & 20
20/22	Pin 05-1171 Socket 05-1173	8-18	05-2661-A20	red	24, 22 & ??
16	Pin 05-1142 Socket 05-1144	8-18	05-2661-16	blue	18 & 16

CPT contacts are available for Shell sizes 8 thru 18 only.

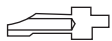

Size 20 solder contact
Nominal rating: 5 amps
Stripping length: 1/8"



Size 16 solder contact
Nominal rating: 15 amps
Stripping length: 3/16"



Size 12 solder contact
Nominal rating: 24 amps
Stripping length: 3/16"



Size 20 contacts S.E. range
Nominal rating: 15 amps
Stripping length: ."

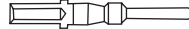

Size 16 contact S.E. range
Nominal rating: 15 amps
Stripping length: 1/4"

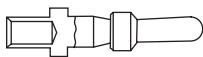

Size 12 contacts S.E. range
Nominal rating: 24 amps
Stripping length: 1/4"

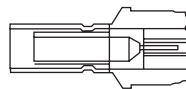

Co axial contacts S.E. range
for RG. 180/U & RG. 195/U
cables or equivalents



Dimensions shown in mm (inch)
Specifications and dimensions subject to change

www.ittcannon.com

Accessories

Panel Mount Protection Caps

Shell Size	Wall/box c/w chain	Wall/box c/w cord	In-line c/w chain	In-line c/w cord	Cap only	N diameter .001 variance	Length .015 variance
8	10-101960-8	05-0517-8	10-101961-8	05-0537-8	10-123094-8	0.734	0.562
10	10-101960-10	05-0517-10	10-101961-10	05-0537-10	10-123094-10	0.859	0.562
12	10-101960-12	05-0517-12	10-101961-12	05-0537-12	10-123094-12	1.000	0.562
14	10-101960-14	05-0517-14	10-101961-14	05-0537-14	10-123094-14	1.125	0.562
16	10-101960-16	05-0517-16	10-101961-16	05-0537-16	10-123094-16	1.250	0.562
18	10-101960-18	05-0517-18	10-101961-18	05-0537-18	10-123094-18	1.375	0.562
20	10-101960-20	05-0517-20	10-101961-20	05-0537-20	10-123094-20	1.500	0.562
22	10-101960-22	05-0517-22	10-101961-22	05-0537-22	10-123094-22	1.625	0.562
24	10-101960-24	05-0517-24	10-101961-24	05-0537-24	10-123094-24	1.750	0.602

Jam Nut Protection Caps

Shell Size	Part Numbers			N diameter .001 Variance	Length .015 Variance
	With Chain	With Cord	Cap Only		
8	10-101964-8	05-0527-8	10-123094-8	0.076	0.572
10	10-101964-10	05-0527-10	10-123094-10	0.816	0.572
12	10-101964-12	05-0527-12	10-123094-12	1.000	0.57
14	10-101964-14	05-0527-14	10-123094-14	1.128	0.572
16	10-101964-16	05-0527-16	10-123094-16	1.267	0.572
18	10-101964-18	05-0527-18	10-123094-18	1.367	0.572
20	10-101964-20	05-0527-20	10-123094-20	1.496	0.572
22	10-101964-22	05-0527-22	10-123094-22	1.624	0.572
24	10-101964-24	05-0527-24	10-123094-24	1.747	0.612

Cable Clamp Grommets

Size	Part
8	10-36565-101
10	10-36565-122
12	10-36565-143
14	10-36565-163
16	10-36565-183
18	10-36565-203
20	10-36565-203
22	10-36565-244
24	10-36565-232

A molded resilient grommet that is designed for use in the jaws of all strain relief clamps, forming a firm grip on the cable sheath. The cable clamp grommet is always specified as a separate item when ordering the clamps.

Plug Protection Caps

Shell Size	With chain	With cord	Cap only	N diameter .001 variance	Length .015 variance
8	05-0057-8	05-0507-8	05-0056-8	0.473	0.532
10	05-0057-10	05-0507-10	05-0056-10	0.590	0.532
12	05-0057-12	05-0507-12	05-0056-12	0.750	0.532
14	05-0057-14	05-0507-14	05-0056-14	0.875	0.532
16	05-0057-16	05-0507-16	05-0056-16	1.000	0.532
18	05-0057-18	05-0507-18	05-0056-18	1.125	0.532
20	05-0057-20	05-0507-20	05-0056-20	1.250	0.594
22	05-0057-22	05-0507-22	05-0056-22	1.375	0.594
24	05-0057-24	05-0507-24	05-0056-24	1.500	0.627

To complete protective cap part numbers add link length as follows + plate finish.

30=3" 35=3.5" 40=4" 45=4.5"
50=5" 60=6" 70=7" 80=8" etc.

Plate finish = see how to order section for each connector type for mod code required. ie 05-0527-8-70-T69 to receive jam nut receptacle cap with cord for size 8 with "&" cord and zinc cobalt plate.

Protective caps are also available with ribbed grip feature, and in other materials such as Nylon 66 and Stainless Steel. Please consult factory.

VEAM PT Connectors

A Threaded Type Adapter 05 0532 XX

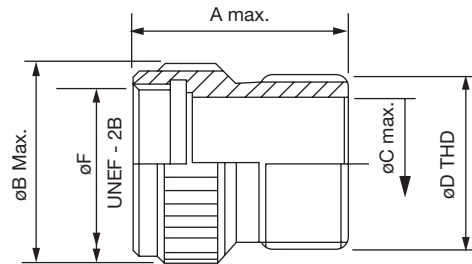

To correctly specify accessory part number replace XX with shell size required and plating needed which can be found in How to order section of each connector type. ie 05 0532 8 T69

Size	Front Thread F	Rear Thread D	Length A	Diameter B
8	7/16 x 28UNEF	1/2 x 28UNEF	0.935	0.590
10	9/16 x 24UNEF	5/8 x 24UNEF	0.935	0.720
12	11/16 x 24UNEF	3/4 x 20UNEF	0.935	0.850
14	13/16 x 20UNEF	7/8 x 20UNEF	0.935	0.980
16	15/16 x 20UNEF	1 x 20UNEF	0.935	1.096
18	1 1/16 x 18UNEF	1 3/16 x 18UNEF	0.935	1.210
20	1 3/16 x 18UNEF	1 3/16 x 18UNEF	0.935	1.350
22	1 5/16 x 18UNEF	1 7/16 x 18UNEF	0.935	1.480
24	1 7/16 x 18unef	1 7/16 x 18UNEF	0.935	1.600

E Type Grommet Clamp Nut 05 0114 XX XX

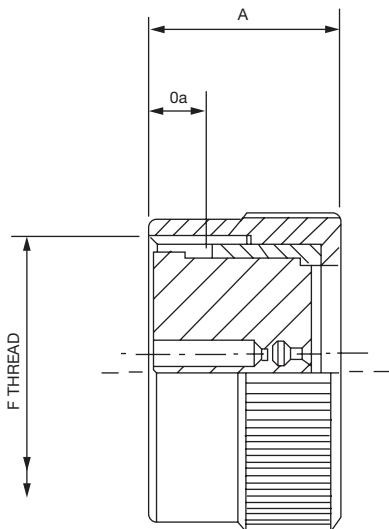

To correctly specify accessory part number replace XX with insert arrangement required and plating needed which can be found in How to order section of each connector type. ie 05 0114 8 98 T69

Size	Front Thread F	Cable Diameter C	Length A	Diameter D
8	7/16 x 28UNEF	0.600	0.650	0.190
10	9/16 x 24UNEF	0.730	0.650	0.190
12	11/16 x 24UNEF	0.860	0.650	0.190
14	13/16 x 20UNEF	0.990	0.650	0.190
16	15/16 x 20UNEF	1.110	0.650	0.190
18	1 1/16 x 18UNEF	1.240	0.650	0.190
20	1 3/16 x 18UNEF	1.360	0.680	0.190
22	1 5/16 x 18UNEF	1.480	0.680	0.190
24	1 7/16 x 18unef	1.510	0.680	0.190

Strain Relief Clamps

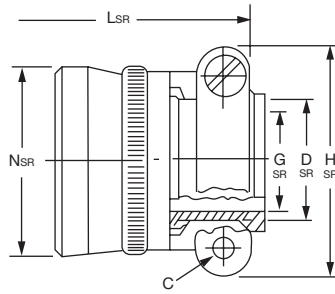

05-1778-XX
Basic SR clamp

05-0120-XX-XX
with Grommet

05-1886-XX
for SE connector

To correctly specify accessory part number replace XX with shell size/insert layout required and plating needed which can be found in How to order section of each connector type. Cable clamp grommet sold separately. See page 33.

Size	Front Thread	Diameter N	Max Clamp Width H	Cable Size G	Length L	Grommet P/N
8	7/16 x 28UNEF	0.550	0.812	0.125	1.761	10-36565-101
10	9/16 x 24UNEF	0.675	0.875	0.188	1.761	10-36565-122
12	11/16 x 24UNEF	0.803	1.000	0.312	1.761	10-36565-143
14	13/16 x 20UNEF	0.920	1.125	0.375	1.761	10-36565-163
16	15/16 x 20UNEF	0.047	1.188	0.500	1.893	10-36565-183
18	1 1/16 x 18UNEF	1.165	1.438	0.625	1.893	10-36565-203
20	1 3/16 x 18UNEF	1.290	1.438	0.625	2.081	10-36565-203
22	1 5/16 x 18UNEF	1.418	1.719	0.750	2.081	10-36565-244
24	1 7/16 x 18unef	1.543	1.750	0.800	2.143	10-36565-232

W Type Sealing Gland 05 2330 XX

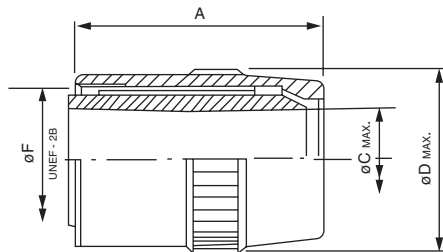

To correctly specify accessory part number replace XX with shell size required and plating needed which can be found in How to order section of each connector type. ie 05 2330 8 T69

Size	Front Thread F	Cable Diameter C	Length A	Diameter D
8	7/16 x 28UNEF	0.230	1.055	0.560
10	9/16 x 24UNEF	0.312	1.055	0.684
12	11/16 x 24UNEF	0.442	1.155	0.810
14	13/16 x 20UNEF	0.539	1.300	0.935
16	15/16 x 20UNEF	0.614	1.524	1.060
18	1 1/16 x 18UNEF	0.672	1.724	1.185
20	1 3/16 x 18UNEF	0.744	1.925	1.310
22	1 5/16 x 18UNEF	0.844	2.135	1.435
24	1 7/16 x 18unef	0.890	2.175	1.560

Dimensions shown in mm (inch)
Specifications and dimensions subject to change

www.ittcannon.com



VEAM PT Connectors

P Type Potting Boot 05 2042 XX

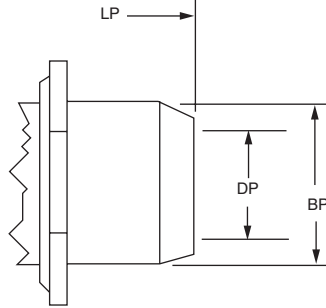

To correctly specify accessory part number replace XX with shell size required and plating needed which can be found in How to order section of each connector type. ie 05 2042 8 T69

Size	Front Thread F	Diameter B	Length L	Outlet Size D
8	7/16 x 28UNEF	0.608	1.526	0.317
10	9/16 x 24UNEF	0.734	1.526	0.434
12	11/16 x 24UNEF	0.858	1.526	0.548
14	13/16 x 20UNEF	0.984	1.526	0.673
16	15/16 x 20UNEF	1.110	1.526	0.798
18	1 1/16 x 18UNEF	1.234	1.526	0.899
20	1 3/16 x 18UNEF	1.360	1.646	1.024
22	1 5/16 x 18UNEF	1.484	1.646	1.149
24	1 7/16 x 18unef	1.610	1.646	1.274

Straight Outlet for Def Stan Cable 05 2058 XX

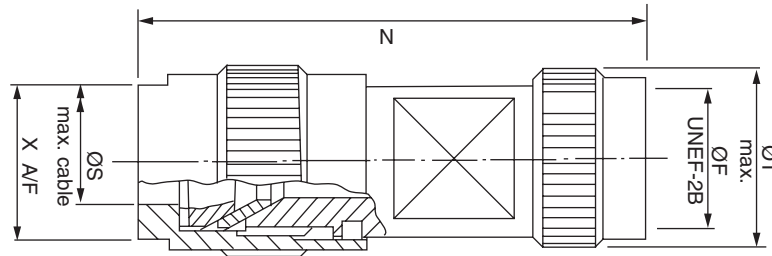

To correctly specify accessory part number replace XX with shell size required and plating needed which can be found in How to order section of each connector type. ie 05 2058 12 T69

Size	Front Thread F	Diameter T	Length N	Max Cable Size
8	7/16 x 28UNEF	0.690	2.020	0.283
10	9/16 x 24UNEF	0.760	2.020	0.343
12	11/16 x 24UNEF	0.856	2.492	0.465
14	13/16 x 20UNEF	1.044	2.516	0.492
16	15/16 x 20UNEF	1.174	2.640	0.575
18	Consult Factory			
20	1 3/16 x 18UNEF	1.404	2.640	0.657
22	Consult Factory			
24	1 7/16 x 18UNEF	1.654	3.015	0.800



Dimensions shown in mm (inch)
Specifications and dimensions subject to change

www.ittcannon.com

75 Degree Outlet with Strain Relief Clamp 995 7732 0XX

(replacement part for 05-2060 75 degree outlet with sealing gland)

To correctly specify accessory part number replace XX with shell size required and plating needed which can be found in How to order section of each connector type. Original backshell was two part open Architecture variant. ie. 05 2060 16 T69

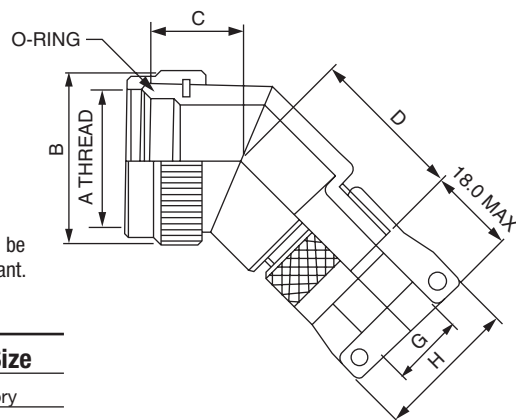

Size	Front Thread A	Diameter B	Length D+18mm	Max Cable Size
8	7/16 x 28UNEF	17.3mm	24.6mm	Consult Factory
10	9/16 x 24UNEF	20.3mm	25.4mm	Consult Factory
12	11/16 x 24UNEF	23.8mm	25.8mm	Consult Factory
14	13/16 x 20UNEF	26.8mm	26.7mm	Consult Factory
16	15/16 x 20UNEF	29.8mm	27.5mm	Consult Factory
18	Consult Factory	33.3mm	27.8mm	Consult Factory
20	1 3/16 x 18UNEF	36.3mm	28.6mm	Consult Factory
22	Consult Factory	39.8mm	29.0mm	Consult Factory
24	1 7/16 x 18UNEF	42.8mm	29.9mm	Consult Factory

90 Degree 1 Piece Outlet with Strain Relief Clamp 995 7711 0XX

(replacement part for 05-1774 two piece outlet with integral clamp)

To correctly specify accessory part number replace XX with shell size required and plating needed which can be found in How to order section of each connector type. Original backshell was two part open Architecture variant. ie 05 1774 16 T69

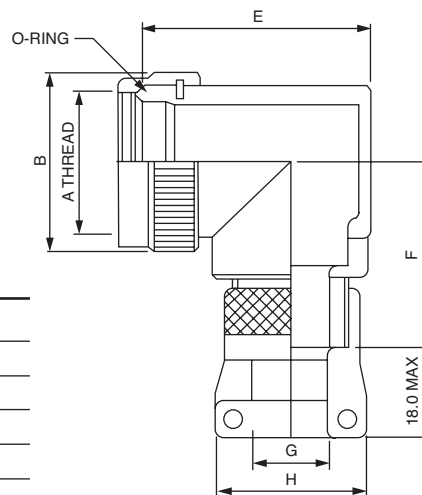

Size	Front Thread A	Diameter B	Length F+18mm	Max Cable Size
8	7/16 x 28UNEF	17.3mm	24.6mm	Consult Factory
10	9/16 x 24UNEF	20.3mm	25.4mm	Consult Factory
12	11/16 x 24UNEF	23.8mm	25.8mm	Consult Factory
14	13/16 x 20UNEF	26.8mm	26.7mm	Consult Factory
16	15/16 x 20UNEF	29.8mm	27.5mm	Consult Factory
18	Consult Factory	33.3mm	27.8mm	Consult Factory
20	1 3/16 x 18UNEF	36.3mm	28.6mm	Consult Factory
22	Consult Factory	39.8mm	29.0mm	Consult Factory
24	1 7/16 x 18UNEF	42.8mm	29.9mm	Consult Factory

Dimensions shown in mm (inch)
Specifications and dimensions subject to change

www.ittcannon.com



VEAM PT Connectors

Special Accessories

(Contact factory for further examples)

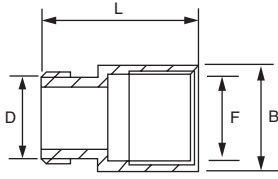

- 05-3226 screw-on direct harness Adapter

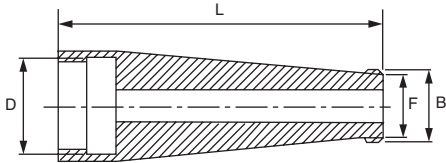

- 05-3228 long screw-on cable support

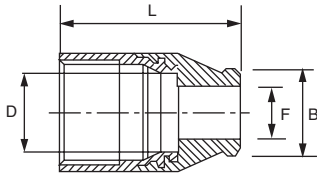

- 05-0564 short screw-on cable support

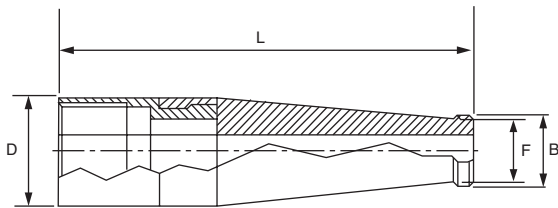

- 05-3229 long screw-on Adapter with screentrap

Special Adapter Dimensions

PART	SHELL SIZE	B DIAMETER	F THREAD	L LENGTH	D CABLE DIAMETER
005-0364-81	8	0.593	.5000 x 28unef	1.185	0.195
05-0364-82	8	0.593	.5000 x 28unef	1.185	0.250
05-3226-1	8	0.593	.5000 x 28unef	0.997	na
05-3228-1	8	0.593	.5000 x 28unef	0.563	0.210
05-3228-11	8	0.593	.5000 x 28unef	2.1320	0.210
05-3228-2	8	0.593	.5000 x 28unef	0.563	0.250
05-3229-1	8	0.593	.5000 x 28unef	1.185	0.997
05-3229-11	8	0.593	.5000 x 28unef	2.760	0.997
05-3229-2	8	0.593	.5000 x 28unef	1.185	0.997
05-0364-101	10	0.719	.6250 x 24unef	1.360	0.195
05-0364-102	10	0.719	.6250 x 24unef	1.360	0.250
05-0364-103	10	0.719	.6250 x 24unef	1.360	0.281
05-0326-2	10	0.719	.6250 x 24unef	1.047	na
05-3228-10	10	0.719	.6250 x 24unef	2.088	0.317
05-3228-3	10	0.719	.6250 x 24unef	0.688	0.195
05-3228-4	10	0.719	.6250 x 24unef	0.688	0.250
05-3228-5	10	0.719	.6250 x 24unef	0.688	0.281
05-3228-7	10	0.719	.6250 x 24unef	2.088	0.215
05-3228-8	10	0.719	.6250 x 24unef	2.088	0.255
05-3228-9	10	0.719	.6250 x 24unef	2.088	0.290
05-3229-10	10	0.719	.6250 x 24unef	2.760	1.047
05-3229-3	10	0.719	.6250 x 24unef	1.360	1.047
05-3229-4	10	0.719	.6250 x 24unef	1.360	1.047
05-3229-5	10	0.719	.6250 x 24unef	1.360	1.047
05-3229-7	10	0.719	.6250 x 24unef	2.760	1.047
05-3229-8	10	0.719	.6250 x 24unef	2.760	1.047
05-3229-9	10	0.719	.6250 x 24unef	2.760	1.047
05-0364-123	12	0.843	.7500 x 20unef	1.310	0.385
05-3226-3	12	0.843	.7500 x 20unef	1.042	na
05-3228-6	12	0.843	.7500 x 20unef	0.643	0.385
05-3229-3	12	0.843	.7500 x 20unef	1.310	1.042

Dimensions shown in mm (inch)
Specifications and dimensions subject to change

www.ittcannon.com



VEAM PT Connectors

Audio Connectors

To complete Audio connector part numbers replace xx with insert arrangement, contact gender, orientation and plating finish.

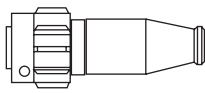
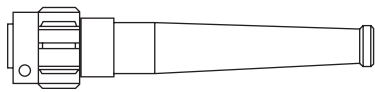
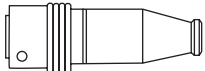
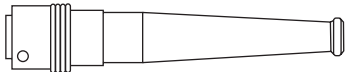
CONNECTOR STYLE	PART NUMBER & DESCRIPTION	CABLE	ARRANGEMENTS							
			8-4	8-33	8-98	10-2	10-6	10-7	10-99	12-10
 STRAIGHT PLUGS (bayonet coupling)	05-0596-XX crimp contacts	Deft STAN 61-12 (pt 7) crimp contacts				•	•	•	•	•
	05-1311-XX crimp contacts for lightweight tinsel cable	SD3/229879 RSRE 040/01	•	•	•		•	•	•	
	05-2041-XX solder contacts		•	•	•	•	•	•	•	•
 STRAIGHT PLUG (bayonet coupling)	05-1093-XX crimp contacts for lightweight tinsel cable	SD3/229879 RSRE 040/01					•	•	•	
	05-2467-XX crimp contacts non pre- ferred use 051093	Deft STAN 61-12 (pt 7) crimp contacts					•	•	•	
 STRAIGHT PLUGS (quick release)	05-0943-XX crimp contacts	Deft STAN 61-12 (pt 7) crimp contacts					•	•	•	
	05-1312-XX crimp contacts for lightweight tinsel cable	SD3/229879 RSRE 040/01					•	•	•	
	05-1630-XX crimp contacts non pre- ferred use 05 1312	SD4/24127 BS.6500 table 16				•				
 STRAIGHT PLUG (quick release)	05-2040-XX crimp contacts	SD3/229879 RSRE 040/01					•	•	•	
	05-2468-XX crimp contacts non pre- ferred use 05 2040	Deft STAN 61-12 (pt 7) crimp contacts					•	•	•	

Audio Connectors

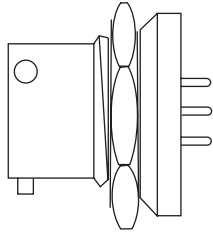
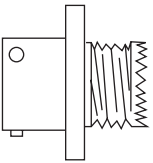
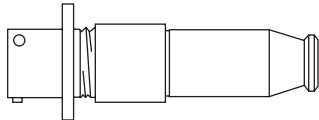
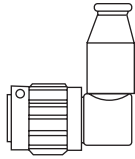
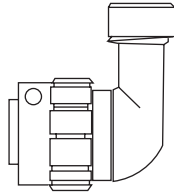
CONNECTOR STYLE	PART NUMBER & DESCRIPTION	CABLE	ARRANGEMENTS							
			8-4	8-33	8-98	10-2	10-6	10-7	10-99	12-10
 <p>PANEL MOUNTING RECEPTACLES (bayonet coupling)</p>	05-0599-XX solder contacts, 'O' ring seal, hexagonal nut only	OPEN WIRING	•			•	•	•	•	•
	05-1626-XX solder contacts, hexagonal nut only	OPEN WIRING	•				•	•	•	
	05-2676-XX solder contacts, 'O' ring seal, hexagonal nut only non preferred use 05 0599	OPEN WIRING				•	•	•	•	•
	05-1319-XX solder contacts, ring nut only	OPEN WIRING	•	•	•					
 <p>PANEL MOUNTING RECEPTACLES</p>	05-1318-XX solder contacts, no fittings	OPEN WIRING					•	•	•	•
 <p>LINE CONNECTING RECEPTACLES</p>	05-0771-XX crimp contacts	SD3/229879 RSRE 040/01					•	•	•	
	05-1941-XX solder contacts	Def STAN 61-12 (pt 4) 7-2-6C				•		•	•	
 <p>90 DEGREE PLUG</p>	05-1320-XX crimp contacts for light-weight tinsel cable	SD3/229879 RSRE 040/01					•	•	•	
 <p>90 DEGREE PLUGS</p>	05-1505-XX solder contacts	Def STAN 61-12 (pt 4) 7-2-6C				•		•	•	•
	05-2049-XX solder contacts	SD4/246127 BS.6500 table 16				•				
	05-2339-XX solder contacts, and screen termination outlet	Def STAN 61-12 (pt 4) 7-2-6C				•		•	•	•

Dimensions shown in mm (inch)
Specifications and dimensions subject to change

www.ittcannon.com

THIS NOTE MUST BE READ IN CONJUNCTION WITH THE PRODUCT DATA SHEET/CATALOG. FAILURE TO OBSERVE THE ADVICE IN THIS INFORMATION SHEET AND THE OPERATING CONDITIONS SPECIFIED IN THE PRODUCT DATA SHEET/ CATALOG COULD RESULT IN HAZARDOUS SITUATIONS.

1. MATERIAL CONTENT AND PHYSICAL FORM

Electrical connectors do not usually contain hazardous materials. They contain conducting and non-conducting materials and can be divided into two groups.

a) Printed circuit types and low cost audio types which employ all plastic insulators and casings.

b) Rugged, Fire Barrier and High Reliability types with metal casings and either natural rubber, synthetic rubber, plastic or glass insulating materials. Contact materials vary with type of connector and also application and are usually manufactured from either: Copper, copper alloys, nickel, alumel, chromel or steel. In special applications, other alloys may be specified.

2. FIRE CHARACTERISTICS AND ELECTRIC SHOCK HAZARD

There is no fire hazard when the connector is correctly wired and used within the specified parameters. Incorrect wiring or assembly of the connector or careless use of metal tools or conductive fluids, or transit damage to any of the component parts may cause electric shock or burns. Live circuits must not be broken by separating mated connectors as this may cause arcing, ionization and burning. Heat dissipation is greater at maximum resistance in a circuit. Hot spots may occur when resistance is raised locally by damage, e.g. cracked or deformed contacts, broken strands of wire. Local overheating may also result from the use of the incorrect application tools or from poor quality soldering or slack screw terminals. Overheating may occur if the ratings in the product Data Sheet/Catalog are exceeded and can cause breakdown of insulation and hence electric shock. If heating is allowed to continue it intensifies by further increasing the local resistance through loss of temper of spring contacts, formation of oxide film on contacts and wires and leakage currents through carbonization of insulation and tracking paths. Fire can then result in the presence of combustible materials and this may release noxious fumes. Overheating may not be visually apparent. Burns may result from touching overheated components.

3. HANDLING

Care must be taken to avoid damage to any component parts of electrical connectors during installation and use. Although there are normally no sharp edges, care must be taken when handling certain components to avoid injury to fingers. Electrical connectors may be damaged in transit to the customers, and damage may result in creation of hazards. Products should therefore be examined prior to installation/use and rejected if found to be damaged.

4. DISPOSAL

Incineration of certain materials may release noxious or even toxic fumes.

5. APPLICATION

Connectors with exposed contacts should not be selected for use on the current supply side of an electrical circuit, because an electric shock could result from touching exposed contacts on an unmated connector. Voltages in excess of 30 V ac or 42.5 V dc are potentially hazardous and care should be taken to ensure that such voltages cannot be transmitted in any way to exposed metal parts of the connector body. The connector and wiring should be checked, before making live, to have no damage to metal parts or insulators, no solder blobs, loose strands, conducting lubricants, swarf, or any other undesired conducting particles. Circuit resistance and continuity check should be made to make certain that there are no high resistance joints or spurious conducting paths. Always use the correct application tools as specified in the Data Sheet/Catalog. Do not permit untrained personnel to wire, assemble or tamper with connectors. For operation voltage please see appropriate national regulations.

IMPORTANT GENERAL INFORMATION

(i) Air and creepage paths/Operating voltage. The admissible operating voltages depend on the individual applications and the valid national and other applicable safety regulations.

For this reason the air and creepage path data are only reference values. Observe reduction of air and creepage paths due to PC board and/or harnessing.

(ii) Temperature

All information given are temperature limits. The operation temperature depends on the individual application.

(iii) Other important information

Cannon continuously endeavors to improve their products. Therefore, Cannon products may deviate from the description, technical data and shape as shown in this catalog and data sheets.

“Engineered for life” is a registered trademark of ITT Corporation ©2006. All other trademarks or registered trademarks are property of their respective owners. All data subject to change without notice.

Product Warranty

ITT Electronic Components, a Division of ITT Corporation manufactures the highest quality products available in the marketplace; however these products are intended to be used in accordance with the specifications in this publication. Any use or application that deviates from the stated operating specifications is not recommended and may be unsafe. No information and data contained in this publication shall be construed to create any liability on the part of Cannon. Any new issue of this publication shall automatically invalidate and supersede any and all previous issues. A limited warranty applies to Cannon products. Except for obligations assumed by Cannon under this warranty, Cannon shall not be liable for any loss, damage, cost of repairs, incidental or consequential damages of any kind, whether or not based on express or implied warranty, contract, negligence or strict liability arising in connection with the design, manufacture, sale, use or repair of the products. Product availability, prices and delivery dates are exclusively subject to our respective order confirmation form; the same applies to orders based on development samples delivered. This publication is not to be construed as an offer. It is intended merely as an invitation to make an offer. By this publication, Cannon does not assume responsibility or any liability for any patent infringements or other rights of third parties which may result from its use. Reprinting this publication is generally permitted, indicating the source. However, Cannon's prior consent must be obtained in all cases.



ITT

VEAM PT Connectors Customer Support Locations

UK

Jays Close, Viables Estate
Basingstoke, RG22 4BA
phone: 44.1256.311200
fax: 44.1256.323356

GERMANY

Cannonstrasse 1
Weinstadt, 71384
phone: 49.7151.699.0
fax: 49.7151.699.217

HONG KONG

Units 2405-6
24/F, ING Tower
308 Des Voeux Road Central
Hong Kong
phone: 852.2732.2720
fax: 852.2732.2919

ITALY

Corso Europa 41/43
Linate (MI),
Italy 20020
phone: 39.02938721
fax: 39.0293872300

FRANCE

15, Boulevard Robert Thiboust
77700 Serris
France
phone: 33.1.60.04.93.93
fax: 33.1.60.04.93.90

USA

100 New Wood Road
Watertown, CT 06795
phone: 1.860.274.9681
fax: 1.860.274.4963

www.ittcannon.com

©2007 ITT Corporation. "Engineered for life" and "Cannon" are registered trademarks of ITT Corporation. Specification and other data are based on information available at the time of printing, and are subject to change without notice.

VPT-aug-07