

REVISIONS				
REV.	ECO. NO	DESCRIPTION	DATE	BY
A	1249	INITIAL RELEASE	01-19-07	MNH
B	1397	UPDATE/CORRECT PCB LAYOUT	6/21/2007	MNH
C	1680	ADDED 'B' MOUNTING INFORMATION	5/6/2008	MNH

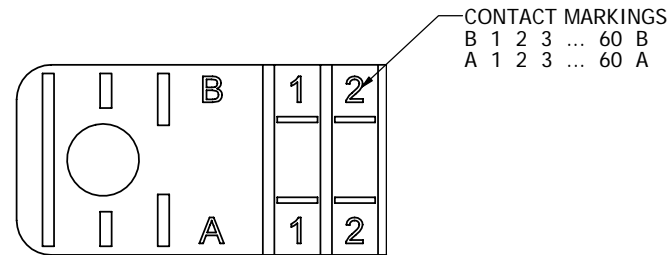

CONTACT ID
SCALE 2:1

- NOTES:
- INSULATOR MATERIAL: SEE PART NUMBER CODING
 - CONTACT MATERIAL: SEE PART NUMBER CODING
 - PLATING: SEE PART NUMBER CODING
 - TEMPERATURE: SEE PART NUMBER CODING
 - PROCESSING TEMP: SEE PART NUMBER CODING
 - UL FLAMMABILITY RATING: 94V-0
 - VOLTAGE RATING: 600 VDC MINIMUM AT SEA LEVEL.
 - CURRENT RATING: 3 AMP PER CONTACT PAIR
 - VOLTAGE DROP: 30 MILLI VOLT AT RATED CURRENT
 - INSULATION RESISTANCE: 5000 MEGA OHM
 - CONNECTOR IDENTIFICATION: THE PART SHALL BE MARKED WITH A PART NUMBER AND BARCODE
 - BOARD THICKNESS ACCOMMODATED: .062 ± .008"
 - BOARD INSERTION FORCE: 16 OZ MAX PER CONTACT PAIR WHEN USING A .062" TEST BLADE. INTERNAL INSPECTION TO BE PER SULLIN'S WORK INSTRUCTION W17.3-01.
 - BOARD WITHDRAWAL FORCE: 1 OUNCE MINIMUM PER CONTACT PAIR USING .062" PCB

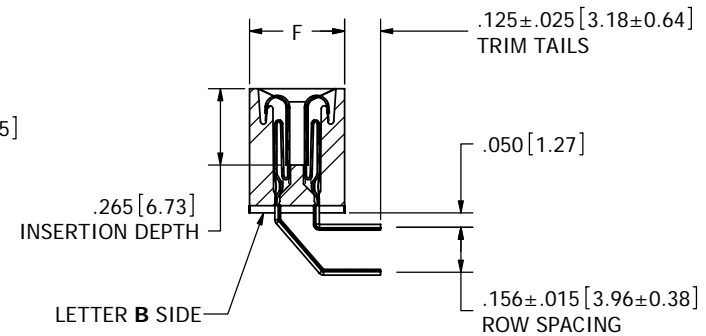
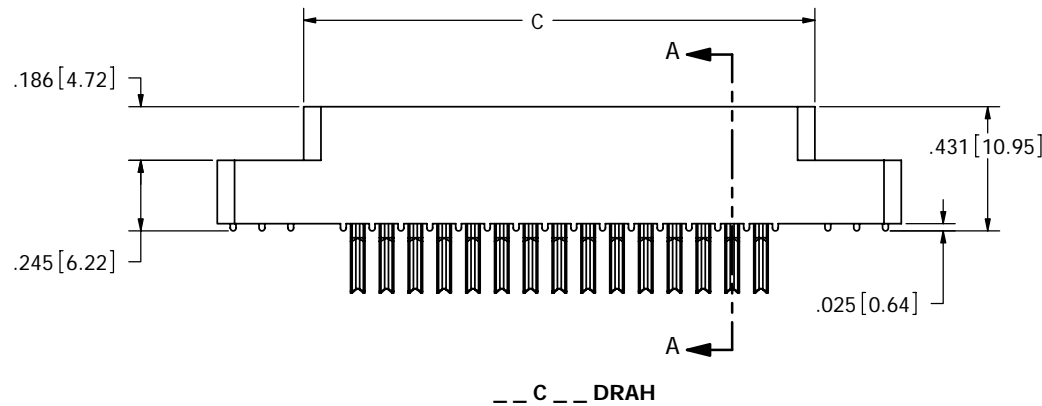
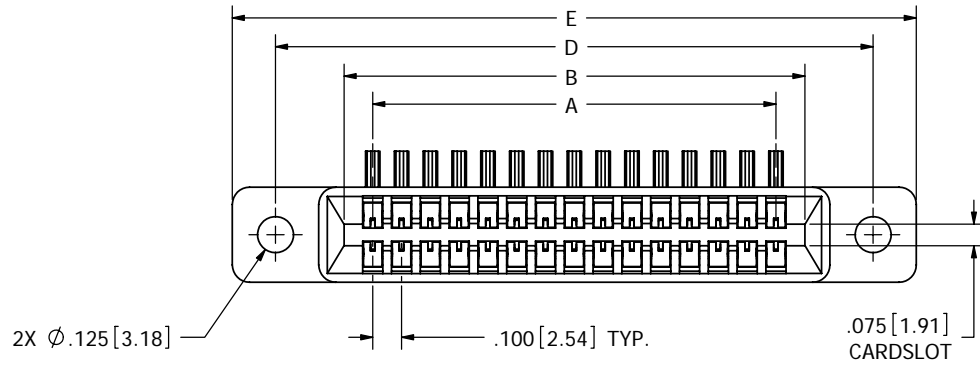

RoHS COMPLIANT

CUSTOMER COPY

UNLESS OTHERWISE SPECIFIED: DIMENSIONS ARE IN INCHES[MM] TOLERANCES: ANGULAR: ± 30° XX ± .02 [508] XXX ± .005 [1270] XXXX ± .0005 [0127] SURFACE FINISH: 63 Ra REMOVE ALL BURRS AND SHARP EDGES .010 MAX		DATE: 01-19-07 NAME: MNH	
THE INFORMATION HEREIN CONTAINS PROPRIETARY INFORMATION OF SULLINS ELECTRONICS AND IS NOT TO BE REPRODUCED, USED OR DISCLOSED TO OTHERS FOR ANY PURPOSE EXCEPT AS SPECIFICALLY AUTHORIZED IN WRITING BY AN OFFICER OF SULLINS ELECTRONICS.		DESCRIPTION: EDGECARD, .100 CC LP	
INTERPRET DIMENSIONS AND GEOMETRIC TOLERANCING PER: ANSI Y14.5M-1994		SIZE: C	PART NUMBER: -- C -- DRA -- DWG. NO: C10876 REV: C
		SCALE: 2:1	SHEET 1 OF 3

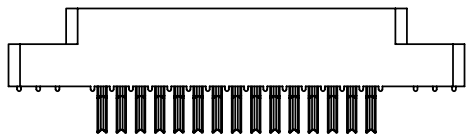
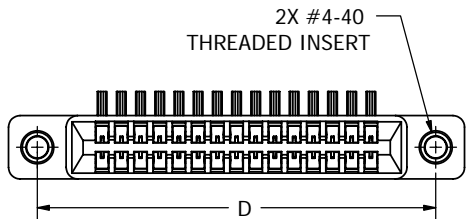

-- C -- DRAI

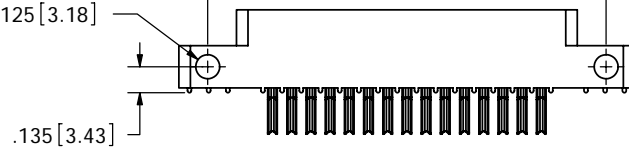
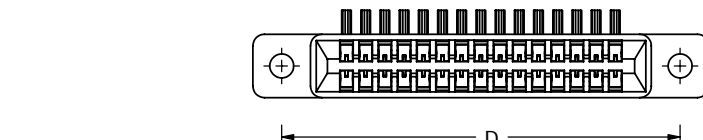

-- C -- DRAS

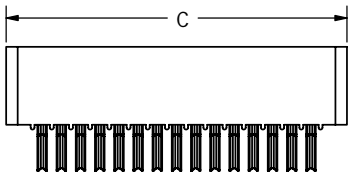
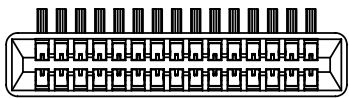

-- C -- DRAN

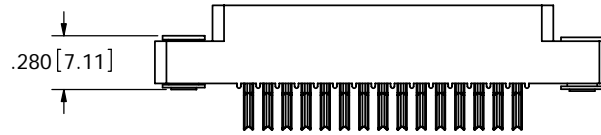
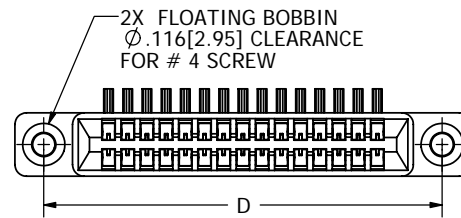

-- C -- DRAF

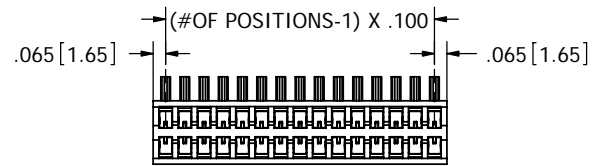

-- C -- DRAB
'B' MOUNTING CONNECTORS AVAILABLE
IN ANY POSITION COUNT FROM 1 TO 65

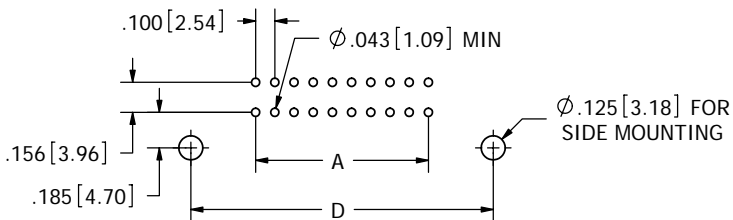

PCB LAYOUT

CUSTOMER COPY



RoHS COMPLIANT

UNLESS OTHERWISE SPECIFIED:
DIMENSIONS ARE IN INCHES[MM]
TOLERANCES:
ANGULAR: ± 30'
XX ± .02 [508]
XXX ± .005 [1270]
XXXX ± .0005 [0127]
SURFACE FINISH: 63 Ra
REMOVE ALL BURRS AND SHARP EDGES .010 MAX

INTERPRET DIMENSIONS AND GEOMETRIC
TOLERANCING
PER: ANSI Y14.5M-1994

DRAWN	DATE	NAME
MNH	01-19-07	MNH

THE INFORMATION HEREIN CONTAINS
PROPRIETARY INFORMATION OF
SULLINS ELECTRONICS AND IS NOT
TO BE REPRODUCED, USED OR
DISCLOSED TO OTHERS FOR ANY
PURPOSE EXCEPT AS SPECIFICALLY
AUTHORIZED IN WRITING BY AN
OFFICER OF SULLINS ELECTRONICS.

DESCRIPTION EDGE CARD, .100 CC LP	
PART NUMBER -- C -- DRA --	
SIZE C	DWG. NO. C10876
SCALE: 2:1	REV C

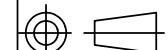

SIZE C	DWG. NO. C10876	REV C
-----------	--------------------	----------

PART NUMBER	NO. OF POS.	A ±.008[0.20]		B ±.008[0.20]		C ±.015[0.38]		D ±.010[0.25]		E ±.020[0.51]		F ±.005[0.13]	
		IN	MM	IN	MM	IN	MM	IN	MM	IN	MM	IN	MM
C04DRA *	4	0.300	7.62	0.500	12.70	0.675	17.15	0.975	24.77	1.275	32.39	0.330	8.38
C05DRA	5	0.400	10.16	0.600	15.24	0.775	19.69	1.075	27.31	1.375	34.93		
C06DRA	6	0.500	12.70	0.700	17.78	0.875	22.23	1.175	29.85	1.475	37.47		
C07DRA	7	0.600	15.24	0.800	20.32	0.975	24.77	1.275	32.39	1.575	40.01		
C08DRA	8	0.700	17.78	0.900	22.86	1.075	27.31	1.375	34.93	1.675	42.55		
C10DRA	10	0.900	22.86	1.100	27.94	1.275	32.39	1.575	40.01	1.875	47.63		
C12DRA	12	1.100	27.94	1.300	33.02	1.475	37.47	1.775	45.09	2.075	52.71		
C13DRA	13	1.200	30.48	1.400	35.56	1.575	40.01	1.875	47.63	2.175	55.25		
C15DRA	15	1.400	35.56	1.600	40.64	1.775	45.09	2.075	52.71	2.375	60.33		
C17DRA	17	1.600	40.64	1.800	45.72	1.975	50.17	2.275	57.79	2.575	65.41		
C18DRA	18	1.700	43.18	1.900	48.26	2.075	52.71	2.375	60.33	2.675	67.95		
C19DRA	19	1.800	45.72	2.000	50.80	2.175	55.25	2.475	62.87	2.775	70.49		
C20DRA	20	1.900	48.26	2.100	53.34	2.275	57.79	2.575	65.41	2.875	73.03		
C22DRA	22	2.100	53.34	2.300	58.42	2.475	62.87	2.775	70.49	3.075	78.11		
C23DRA *	23	2.200	55.88	2.400	60.96	2.575	65.41	2.875	73.03	3.175	80.65		
C25DRA	25	2.400	60.96	2.600	66.04	2.775	70.49	3.075	78.11	3.375	85.73		
C26DRA	26	2.500	63.50	2.700	68.58	2.875	73.03	3.175	80.65	3.475	88.27		
C28DRA	28	2.700	68.58	2.900	73.66	3.075	78.11	3.375	85.73	3.675	93.35		
C30DRA	30	2.900	73.66	3.100	78.74	3.275	83.19	3.575	90.81	3.875	98.43		
C31DRA	31	3.000	76.20	3.200	81.28	3.375	85.73	3.675	93.35	3.975	100.97		
C35DRA	35	3.400	86.36	3.600	91.44	3.775	95.89	4.075	103.51	4.375	111.13		
C36DRA	36	3.500	88.90	3.700	93.98	3.875	98.43	4.175	106.05	4.475	113.67		
C40DRA	40	3.900	99.06	4.100	104.14	4.275	108.59	4.575	116.21	4.875	123.83		
C43DRA	43	4.200	106.68	4.400	111.76	4.575	116.21	4.875	123.83	5.175	131.45		
C44DRA	44	4.300	109.22	4.500	114.30	4.675	118.75	4.975	126.37	5.275	133.99		
C49DRA	49	4.800	121.92	5.000	127.00	5.175	131.45	5.475	139.07	5.775	146.69		
C50DRA	50	4.900	124.46	5.100	129.54	5.275	133.99	5.575	141.61	5.875	149.23		
C52DRA *	52	5.100	129.54	5.300	134.62	5.475	139.07	5.775	146.69	6.075	154.31		
C60DRA	60	5.900	149.86	6.100	154.94	6.275	159.39	6.575	167.01	6.875	174.63		
C65DRA	65	6.400	162.56	6.600	167.64	6.775	172.09	7.075	179.71	7.375	187.33		

* CONSULT FACTORY FOR AVAILABILITY

PART NUMBER CODING

--- C --- DRA ---

MATERIAL (INSULATOR/CONTACT)

E = PBT/PHOSPHOR BRONZE
 OPERATING TEMP: -65°C TO +125°C
 PROCESSING TEMP: 260°C FOR 10 SECS MAX

R = PPS/PHOSPHOR BRONZE
 OPERATING TEMP: -65°C TO +125°C
 PROCESSING TEMP: 260°C FOR 120 SECS MAX

G = PA9T/PHOSPHOR BRONZE
 OPERATING TEMP: -65°C TO +125°C
 PROCESSING TEMP: 260°C FOR 120 SECS MAX

H = PBT/BERYLLIUM COPPER
 OPERATING TEMP: -65°C TO +125°C
 PROCESSING TEMP: 260°C FOR 10 SECS MAX

A = PPS/BERYLLIUM COPPER
 OPERATING TEMP: -65°C TO +150°C
 PROCESSING TEMP: 260°C FOR 120 SECS MAX

J = PA9T/BERYLLIUM COPPER
 OPERATING TEMP: -65°C TO +150°C
 PROCESSING TEMP: 260°C FOR 120 SECS MAX

F = PPS/SPINODAL (CONSULT FACTORY FOR SPECIAL SOLDERING REQUIREMENTS)
 OPERATING TEMP: -65°C TO +200°C
 PROCESSING TEMP: 260°C FOR 120 SECS MAX
 AVAILABLE IN OVERALL GOLD ONLY (S OR M PLATING CODE)

C = PPS/BERYLLIUM NICKEL (CONSULT FACTORY)
 OPERATING TEMP: -65°C TO +200°C
 PROCESSING TEMP: 260°C FOR 120 SECS MAX
 AVAILABLE IN OVERALL GOLD ONLY (S OR M PLATING CODE)

W = PEEK/BERYLLIUM NICKEL (CONSULT FACTORY)
 OPERATING TEMP: -65°C TO +250°C
 AVAILABLE IN OVERALL GOLD ONLY (S OR M PLATING CODE)

NUMBER OF POSITIONS (CONTACTS PER ROW)

PLATING
 ALL PLATINGS ARE LEAD FREE AND HAVE .000050" NICKEL UNDERPLATE

CONTACT SURFACE TERMINATION

G = .000010" GOLD .000005" GOLD
 Y = .000030" GOLD .000005" GOLD
 B = .000010" GOLD .000100" PURE TIN, MATTE
 C = .000030" GOLD .000100" PURE TIN, MATTE

* E = .000100" PURE TIN, MATTE, OVERALL
 S = .000010" GOLD OVERALL
 M = .000030" GOLD .000010" GOLD OVERALL

** OVERALL TIN ONLY AVAILABLE ON MATERIAL CODES E, R AND G

MOUNTING STYLE

H = .125" DIA. CLEARANCE HOLES (PAGE 1)
 I = #4-40 THREADED INSERT (PAGE 2)
 S = .125" DIA. SIDE MOUNTING (PAGE 2)
 N = NO MOUNTING EARS (PAGE 2)
 F = FLOATING BOBBIN (PAGE 2)
 B = OPEN ENDED (PAGE 2)

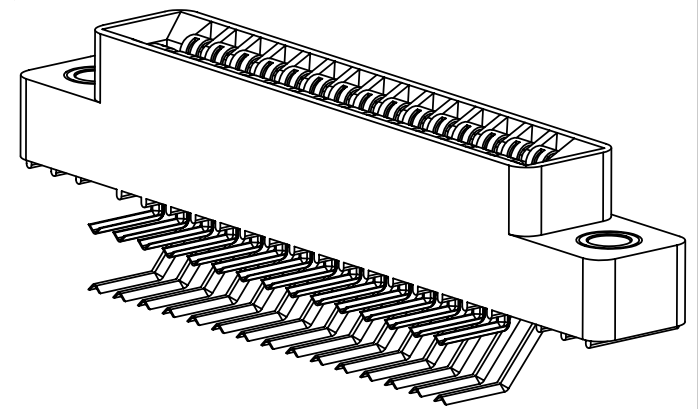

CUSTOMER COPY

UNLESS OTHERWISE SPECIFIED:
 DIMENSIONS ARE IN INCHES[MM]
 TOLERANCES:
 ANGULAR: ± 30'
 XX ± .02 [508]
 XXX ± .005 [1270]
 XXXX ± .0005 [0127]
 SURFACE FINISH: 63 Ra
 REMOVE ALL BURRS AND SHARP EDGES .010 MAX

INTERPRET DIMENSIONS AND GEOMETRIC TOLERANCING PER: ANSI Y14.5M-1994

DRAWN	01-19-07	DATE	MNH	NAME
THE INFORMATION HEREIN CONTAINS PROPRIETARY INFORMATION OF SULLINS ELECTRONICS AND IS NOT TO BE REPRODUCED, USED OR DISCLOSED TO OTHERS FOR ANY PURPOSE EXCEPT AS SPECIFICALLY AUTHORIZED IN WRITING BY AN OFFICER OF SULLINS ELECTRONICS.				
DESCRIPTION EDGECARD, .100 CC LP				
PART NUMBER --- C --- DRA ---				
SIZE	DWG. NO.		REV	
C	C10876		C	
SCALE: 4:1				SHEET 3 OF 3



RoHS COMPLIANT