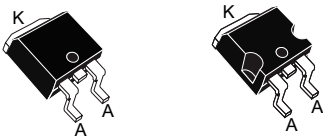
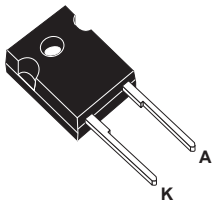
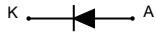

600 V ultrafast rectifier

 D²PAK

Features

- Ultrafast switching
- Low reverse current
- Low thermal resistance
- Reduces switching and conduction losses

Applications

- Telecom power supply
- OBC
- Industrial equipments
- Switching diode

Description

The **STTH30L06**, which is using ST Turbo 2 600 V technology, is specially suited for use in switching power supplies, and industrial applications, as rectification and discontinuous mode PFC boost diode.

Product status

STTH30L06

Product summary

$I_{F(AV)}$	30 A
V_{RRM}	600 V
$T_j(max.)$	175 °C
$V_F(typ.)$	1.00 V
$t_{rr(max.)}$	65 ns

1 Characteristics

Table 1. Absolute ratings (limiting values at 25 °C, unless otherwise specified)

Symbol	Parameter	Value	Unit
V_{RRM}	Repetitive peak reverse voltage	600	V
$I_{F(RMS)}$	Forward rms current	50	A
$I_{F(AV)}$	Average forward current $\delta = 0.5$, square wave	$T_C = 120\text{ °C}$ 30	A
I_{FSM}	Surge non repetitive forward current	$t_p = 10\text{ ms}$ sinusoidal 300	A
T_{stg}	Storage temperature range	-65 to +175	°C
T_j	Maximum operating junction temperature	175	°C

Table 2. Thermal resistance parameter

Symbol	Parameter	Value	Unit
$R_{th(j-c)}$	Junction to case	1.1	°C/W

For more information, please refer to the following application note:

- AN5088: Rectifiers thermal management, handling and mounting recommendations

Table 3. Static electrical characteristics

Symbol	Parameter	Test conditions	Min.	Typ.	Max.	Unit	
$I_R^{(1)}$	Reverse leakage current	$T_j = 25\text{ °C}$	$V_R = V_{RRM}$	-		25	μA
		$T_j = 150\text{ °C}$		-	80	800	
$V_F^{(2)}$	Forward voltage drop	$T_j = 25\text{ °C}$	$I_F = 30\text{ A}$	-		1.55	V
		$T_j = 150\text{ °C}$		-	1.00	1.25	

1. Pulse test: $t_p = 5\text{ ms}$, $\delta < 2\%$

2. Pulse test: $t_p = 380\text{ }\mu\text{s}$, $\delta < 2\%$

To evaluate the conduction losses, use the following equation: $P = 0.95 \times I_{F(AV)} + 0.010 \times I_F^2_{(RMS)}$

For more information, please refer to the following application notes related to the power losses:

- AN604: Calculation of conduction losses in a power rectifier
- AN4021: Calculation of reverse losses in a power diode

Table 4. Dynamic characteristics

Symbol	Parameter	Test conditions	Min.	Typ.	Max.	Unit	
t_{rr}	Reverse recovery time	$T_j = 25\text{ °C}$	$I_F = 0.5\text{ A}$, $I_{rr} = 0.25\text{ A}$, $I_R = 1\text{ A}$	-		65	ns
				-	65	90	
t_{fr}	Forward recovery time	$T_j = 25\text{ °C}$	$I_F = 30\text{ A}$, $V_{FR} = 1.1 \times V_{Fmax}$, $dI_F/dt = 100\text{ A}/\mu\text{s}$	-		500	ns
V_{FP}	Peak forward voltage	$T_j = 25\text{ °C}$	$I_F = 30\text{ A}$, $V_{FR} = 1.1 \times V_{Fmax}$, $dI_F/dt = 100\text{ A}/\mu\text{s}$	-	2.5		V
I_{RM}	Reverse recovery current	$T_j = 125\text{ °C}$	$I_F = 30\text{ A}$, $V_R = 400\text{ V}$, $dI_F/dt = 100\text{ A}/\mu\text{s}$	-	11.5	16	A

1.1 Characteristics (curves)

Figure 1. Conduction losses versus average forward current

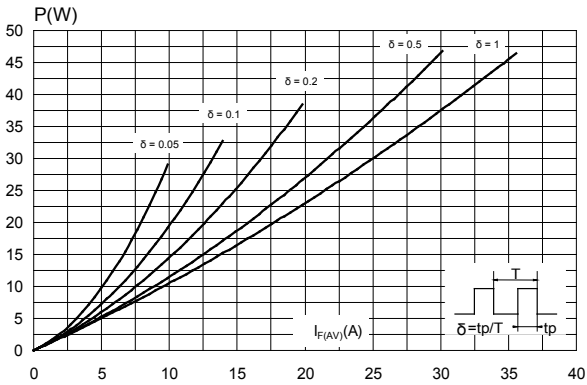

Figure 2. Forward voltage drop versus forward current

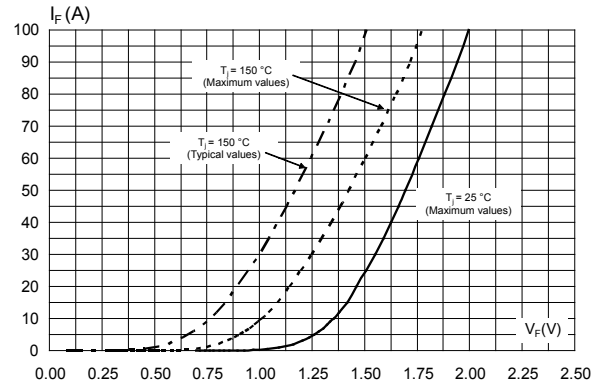

Figure 3. Relative variation of thermal impedance junction to case versus pulse duration

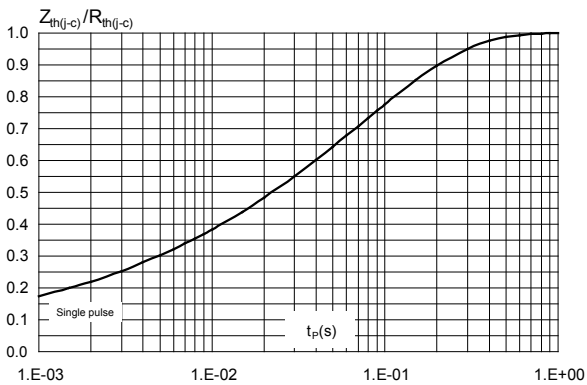

Figure 4. Peak reverse recovery current versus di_F/dt (typical values)

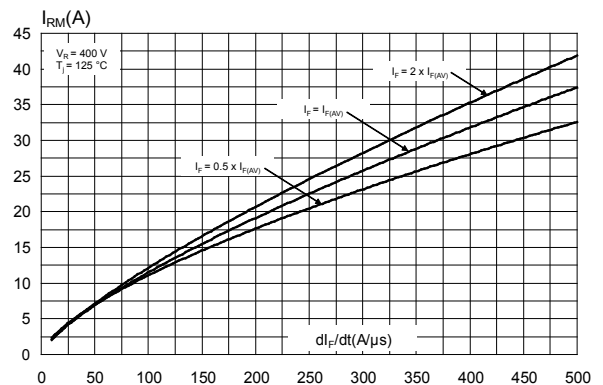

Figure 5. Reverse recovery time versus di_F/dt (typical values)

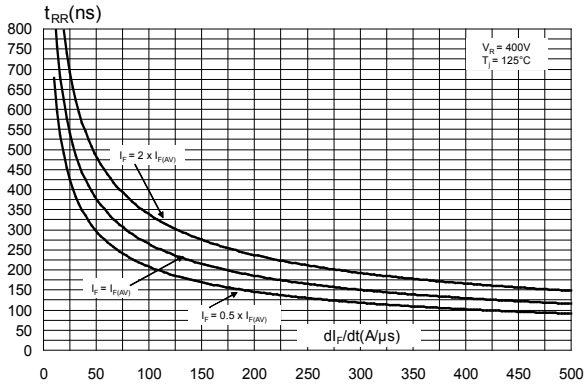

Figure 6. Reverse recovery charges versus di_F/dt (typical values)

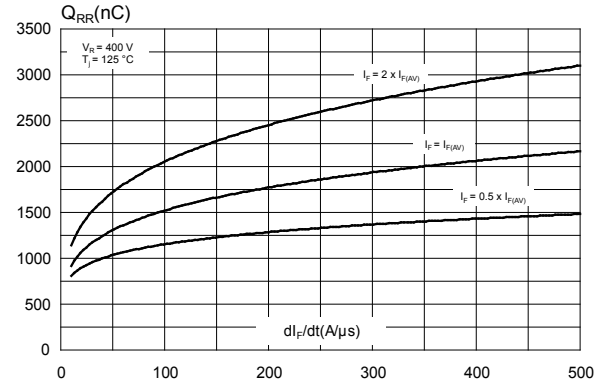

Figure 7. Reverse recovery softness factor versus di_F/dt (typical values)

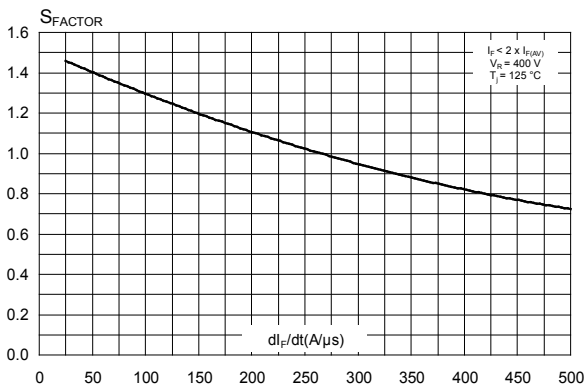

Figure 8. Relative variations of dynamic parameters versus junction temperature

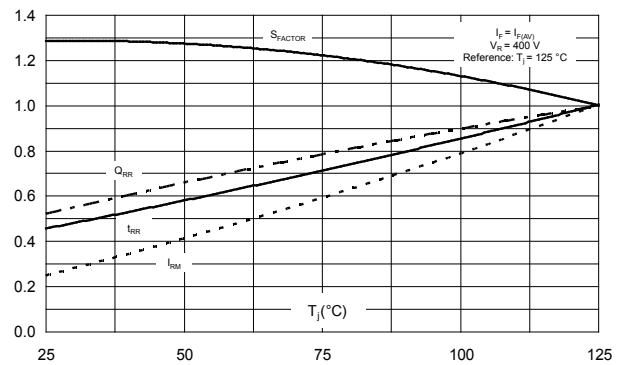

Figure 9. Transient peak forward voltage versus di_F/dt (typical values)

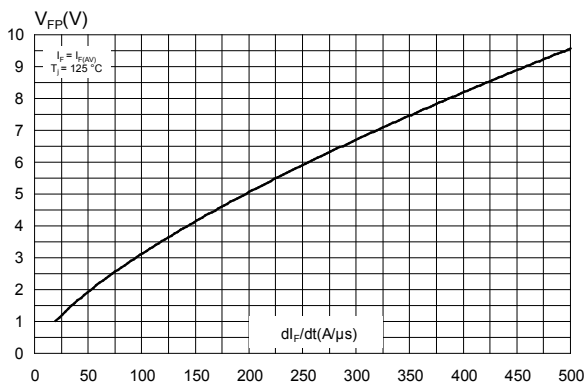

Figure 10. Junction capacitance versus reverse voltage applied (typical values)

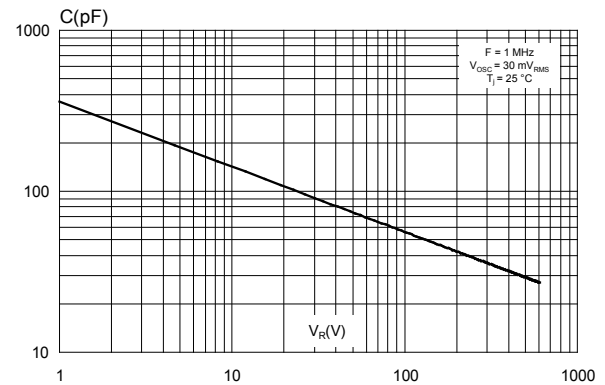
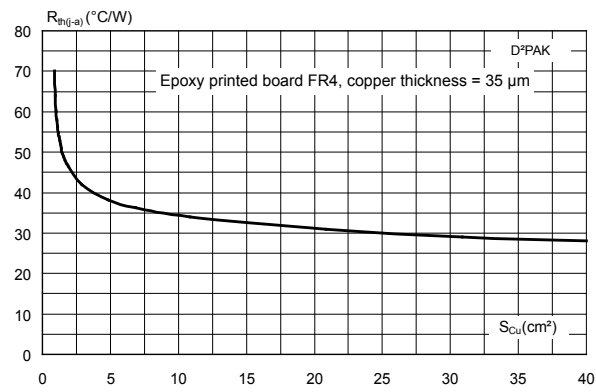

Figure 11. Thermal resistance, junction to ambient, versus copper surface under tab



2 Package information

In order to meet environmental requirements, ST offers these devices in different grades of ECOPACK® packages, depending on their level of environmental compliance. ECOPACK® specifications, grade definitions and product status are available at: www.st.com. ECOPACK® is an ST trademark.

2.1 D²PAK package information

- Epoxy meets UL94, V0
- Cooling method: by conduction (C)

Figure 12. D²PAK package outline

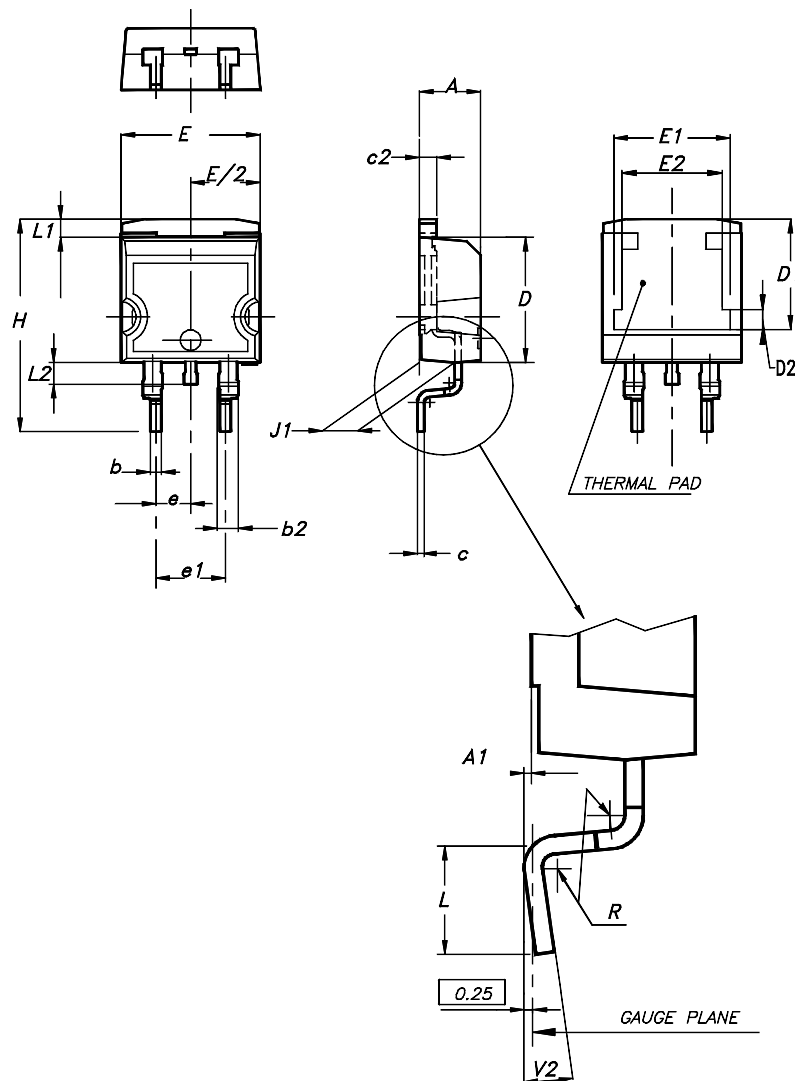

Note: This package drawing may slightly differ from the physical package. However, all the specified dimensions are guaranteed.

Table 5. D²PAK package mechanical data

Ref.	Dimensions			
	Millimeters		Inches (for reference only)	
	Min.	Max.	Min.	Max.
A	4.36	4.60	0.172	0.181
A1	0.00	0.25	0.000	0.010
b	0.70	0.93	0.028	0.037
b2	1.14	1.70	0.045	0.067
c	0.38	0.69	0.015	0.027
c2	1.19	1.36	0.047	0.053
D	8.60	9.35	0.339	0.368
D1	6.90	8.00	0.272	0.311
D2	1.10	1.50	0.043	0.060
E	10.00	10.55	0.394	0.415
E1	8.10	8.90	0.319	0.346
E2	6.85	7.25	0.266	0.282
e	2.54 typ.		0.100	
e1	4.88	5.28	0.190	0.205
H	15.00	15.85	0.591	0.624
J1	2.49	2.90	0.097	0.112
L	1.90	2.79	0.075	0.110
L1	1.27	1.65	0.049	0.065
L2	1.30	1.78	0.050	0.070
R	0.4 typ.		0.015	
V2	0°	8°	0°	8°

Figure 13. D²PAK recommended footprint (dimensions in mm)

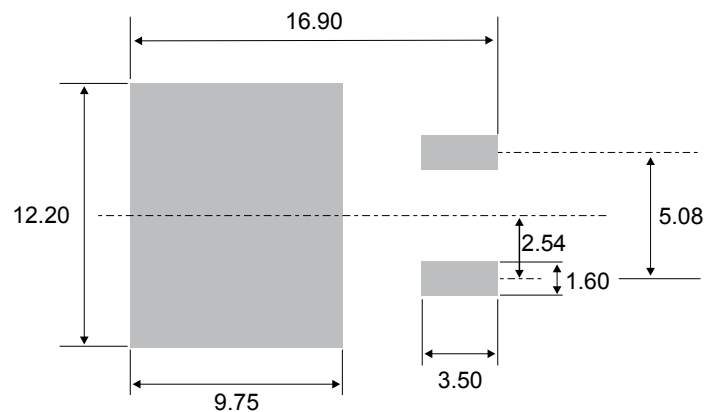

2.2 DO-247 package information

- Epoxy meets UL94, V0
- Cooling method: by conduction (C)
- Recommended torque value: 0.8 N·m
- Maximum torque value: 1.0 N·m

Figure 14. DO-247 package outline

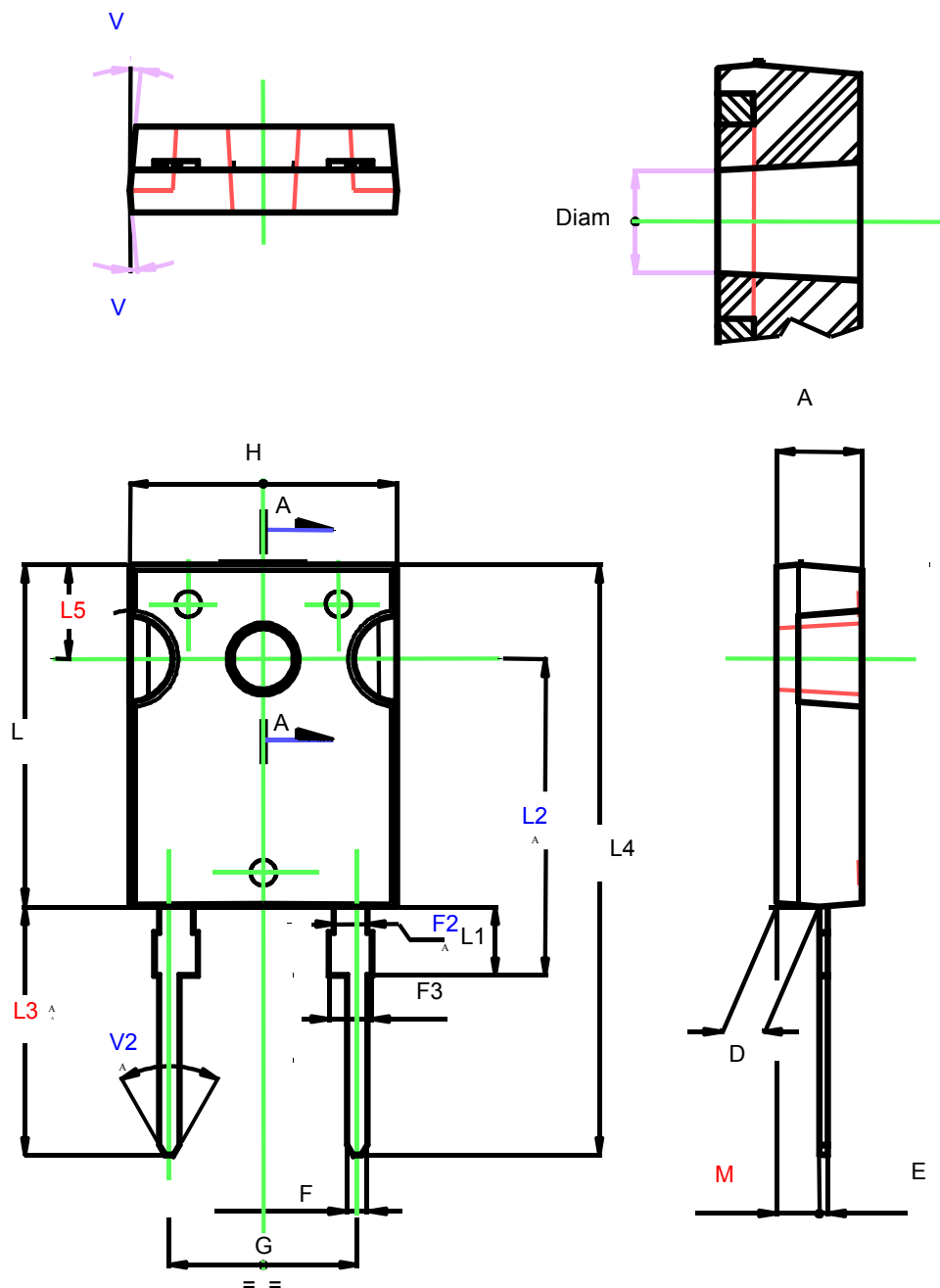

Table 6. DO-247 package mechanical data

Ref.	Dimensions					
	Millimeters			Inches (for reference only)		
	Min.	Typ.	Max.	Min.	Typ.	Max.
A	4.85		5.15	0.1909		0.2027
D	2.2		2.6	0.0866		0.1023
E	0.4		0.8	0.0157		0.0314
F	1		1.4	0.0393		0.0551
F2		2			0.0787	
F3	2		2.4	0.0787		0.0944
G		10.9			0.4291	
H	15.45		15.75	0.6082		0.6200
L	19.85		20.15	0.7814		0.7933
L1	3.7		4.3	0.1456		0.1692
L2		18.5			0.7283	
L3	14.2		14.8	0.5590		0.5826
L4		34.6			1.3622	
L5		5.5			0.2165	
M	2		3	0.0787		0.1181
V		5°			5°	
V2		60°			60°	
Diam.	3.55		3.65	0.1397		0.1437

3 Ordering information

Table 7. Ordering information

Order code	Marking	Package	Weight	Base qty.	Delivery mode
STTH30L06G	STTH30L06G	D ² PAK	1.48 g	50	Tube
STTH30L06G-TR	STTH30L06G	D ² PAK	1.48 g	1000	Tape and reel
STTH30L06W	STTH30L06W	DO-247	4.40 g	30	Tube

Revision history

Table 8. Document revision history

Date	Revision	Changes
07-Sep-2004	1	First issue.
21-Oct-2004	2	DOP3I package added.
11-Jan-06	3	On page 2: <ul style="list-style-type: none"> • $I_{F(RMS)}$ corrected from 30 A to 50 A • $I_{F(AV)}$ corrected from 50 A to 30 A
10-Aug-2006	4	Reformatted to current standards. SOD-93 package removed.
06-Sep-2011	5	Updated I_{FSM} from 160 A to 300 A. Removed TO-220 and DOP3I.
09-Nov-2017	6	Removed D ² PAK package. Minor text change to improve readability.
10-Jan-2018	7	Updated Table 7: "Ordering information"
25-Sep-2018	8	Added D ² PAK package. Updated Table 7. Ordering information . Removed figure 10.

IMPORTANT NOTICE – PLEASE READ CAREFULLY

STMicroelectronics NV and its subsidiaries (“ST”) reserve the right to make changes, corrections, enhancements, modifications, and improvements to ST products and/or to this document at any time without notice. Purchasers should obtain the latest relevant information on ST products before placing orders. ST products are sold pursuant to ST’s terms and conditions of sale in place at the time of order acknowledgement.

Purchasers are solely responsible for the choice, selection, and use of ST products and ST assumes no liability for application assistance or the design of Purchasers’ products.

No license, express or implied, to any intellectual property right is granted by ST herein.

Resale of ST products with provisions different from the information set forth herein shall void any warranty granted by ST for such product.

ST and the ST logo are trademarks of ST. All other product or service names are the property of their respective owners.

Information in this document supersedes and replaces information previously supplied in any prior versions of this document.

© 2018 STMicroelectronics – All rights reserved