

DP3T-SPDT Coaxial Switches DC to 6 GHz, DC to 20 GHz, DC to 26.5 GHz, DC to 40 GHz

Radiall's PLATINUM SERIES switches are optimised to perform at a high level over an extended life span. With outstanding RF performances, and a guaranteed Insertion Loss repeatability of 0.03 dB over a life span of 10 million switching cycles. PLATINUM SERIES switches are perfect for automated test and measurement equipment, as well as signal monitoring devices.

PART NUMBER SELECTION

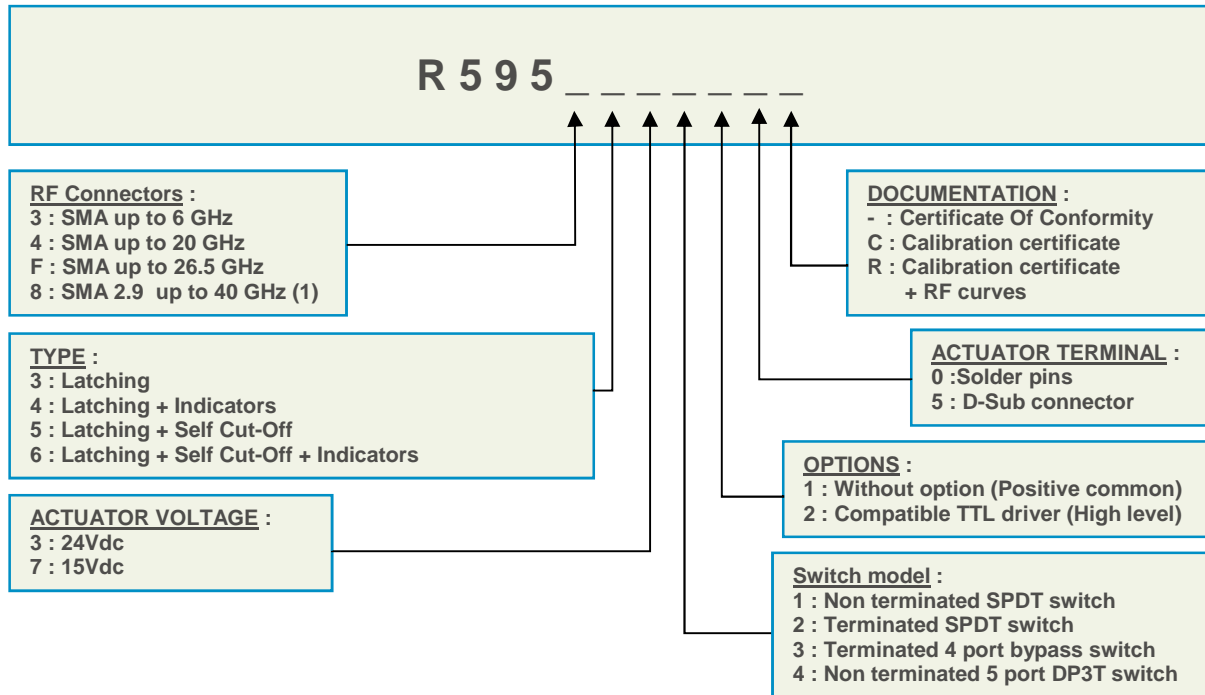

(1) Connector SMA2.9 is equivalent to "K Connector[®]", registered trademark of Anritsu

PICTURE



RF PERFORMANCES

PART NUMBER	R5953-----	R5954-----	R595F-----	R5958-----
Frequency Range GHz	DC to 6	DC to 20	DC to 26.5	DC to 40
Impedance Ohms	50			
Insertion Loss dB (Maximum)	0.20 + (0.45 / 26.5) x frequency (GHz)			
Isolation dB (Minimum)	85	DC to 6 GHz : 85 6 to 12.4 GHz : 75 12.4 to 20 GHz : 65	DC to 6 GHz : 85 6 to 12.4 GHz : 75 12.4 to 20 GHz : 65 20 to 26.5 GHz : 60	DC to 6 GHz : 85 6 to 12.4 GHz : 75 12.4 to 20 GHz : 65 20 to 26.5 GHz : 60 26.5 to 40 GHz : 55
V.S.W.R. (Maximum)	1.15	DC to 6 GHz : 1.15 6 to 12.4 GHz : 1.25 12.4 to 20 GHz : 1.30	DC to 6 GHz : 1.15 6 to 12.4 GHz : 1.25 12.4 to 20 GHz : 1.30 20 to 26.5 GHz : 1.60	DC to 6 GHz : 1.15 6 to 12.4 GHz : 1.25 12.4 to 20 GHz : 1.30 18 to 26.5 GHz : 1.60 26.5 to 40 GHz : 1.80
Third order Inter Modulation	-120 dBc typical (2 carriers 20W)			
Repeatability (up to 10 million cycles measured at 25°C)	0.03 dB maximum			0.05 dB maximum

TYPICAL RF PERFORMANCES

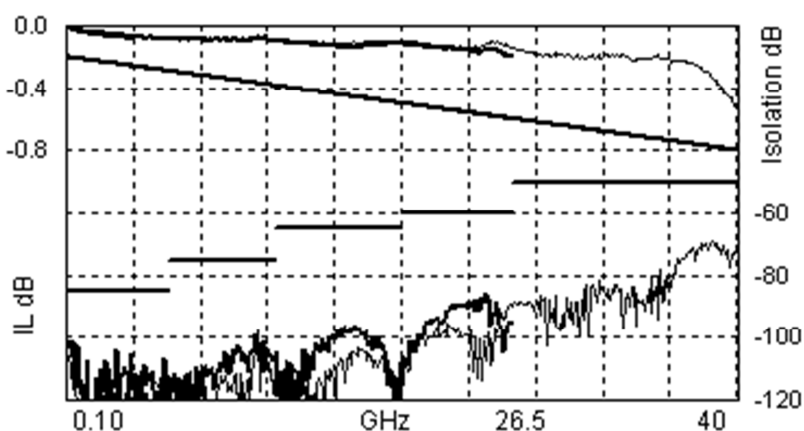

Insertion Loss and Isolation :

- 26.5GHz model with SMA connector
- 40GHz model with SMA2.9 connector

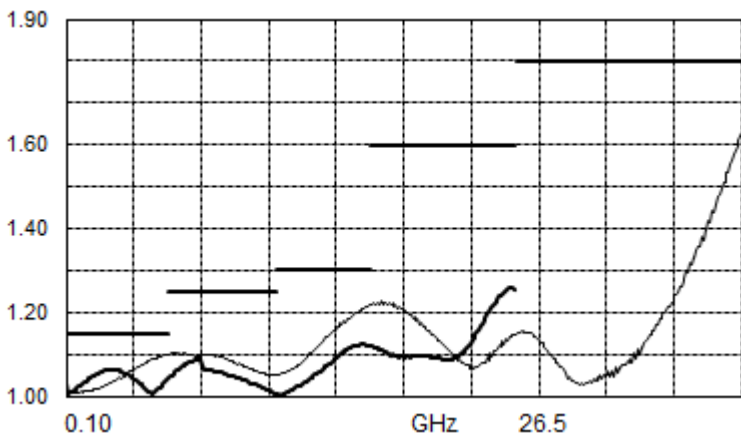

V.S.W.R. :

- 26.5GHz model with SMA connector
- 40GHz model with SMA2.9 connector

ADDITIONAL SPECIFICATIONS

Operating mode		Latching	
Nominal operating voltage (Vdc) (across operating temperature)			24 (20 / 32) 15 (12 / 20)
Coil resistance (+/-10%) (Ohms)		SPDT	350 120
		Terminated SPDT, DP3T, Bypass	175 60
Nominal operating current at 23°C (mA)		SPDT	68 125
		Terminated SPDT, DP3T, Bypass	140 250
Average power	All models	RF path Cold switching : See Power Rating Chart on final page Hot switching : 1 Watt CW	
	Terminated model	Internal terminations 1 Watt average into 50Ω	
		External terminations 0.5 Watt average into 50Ω	
TTL input	High Level	3 to 7 V	800 μA max at 7 V
	Low Level	0 to 0.8 V	20 μA max at 0.8V
Switching time max (ms)		15	
Life min for	SMA	10 million cycles	
	SMA 2.9	5 million cycles	
Connectors		SMA – SMA 2.9	
Actuator terminal		D-Sub pin female Solder pins	
Weight max (g)	SPDT	< 60	
	Terminated SPDT, DP3T, Bypass	< 100	

ENVIRONMENTAL SPECIFICATIONS

Operating temperature range (°C)	-25 to +75
Storage temperature range (°C)	-55 to +85
Temperature cycling (MIL-STD-202 , Method 107D , Cond.A) (°C)	-55 to +85 (10 cycles)
Sine vibration operating (MIL STD 202 , Method 204D , Cond.D)	10-2000 Hz, 20g
Random vibration operating	16.91g (rms) 50–2000 Hz 3min/axis
Shock operating (MIL STD 202 , Method 213B , Cond.G)	50g / 11 ms, sawtooth
Humidity operating	15 to 95% relative humidity
Humidity storage (MIL STD 202 , Method 106E , Cond.E)	65°C, 95% RH, 10 days
Altitude operating	15,000 feet (4,600 meters)
Altitude storage (MIL STD 202 , Method 105C , Cond.B)	50,000 feet (15,240 meters)

SWITCH MODEL 1 : NON TERMINATED SPDT SWITCH

The non-terminated SPDT switch is a single pole double throw switch. This switch is "break before make".

RF SCHEMATIC DIAGRAM



INDICATORS POSITION



Standard drive option "1" (Positive common):

- Connect pin +Vcc to supply
- Select desired RF path by applying ground to the corresponding "Close" pin (Ex: ground pin E1 to switch to position E1. RF path 1-2 closed and RF path 2-3 open).
- To open desired path and close the new RF path, connect ground to the corresponding "close" pin (Ex: ground pin E2 to open RF path 1-2 and close RF path 2-3)

TTL drive option "2"

- Connect pin GND to ground.
- Connect pin +Vcc to supply
- Select (close) desired RF path by applying TTL "High" to the corresponding "drive" pin (Ex: apply TTL "High" to pin E1 to switch to position E1. RF path 1-2 closed and RF path 2-3 open).
- To open desired path and close the new RF path, apply TTL "High" to the "drive" pin which corresponds to the desired RF path. (Ex: apply TTL "High" to pin E2 to open RF path 1-2 and close RF path 2-3).

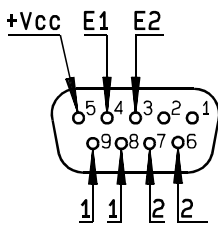

D-Sub connector

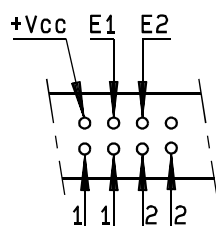

Solder pins

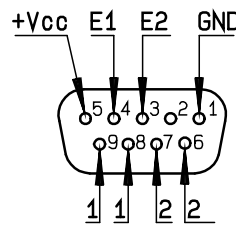

D-Sub connector

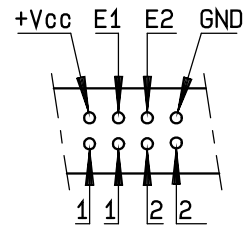

Solder pins

All dimensions are in millimetres [inches].

With D-Sub connector

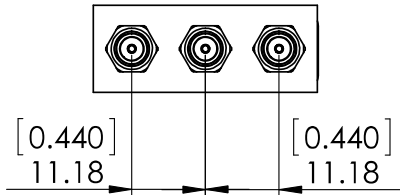

With solder pins

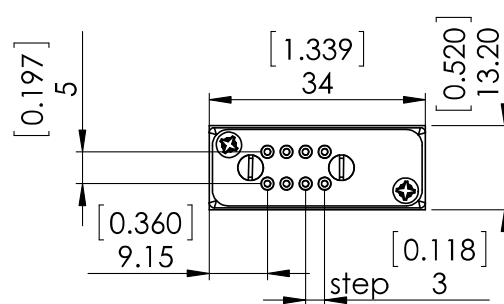
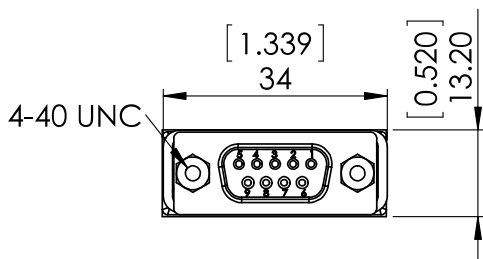
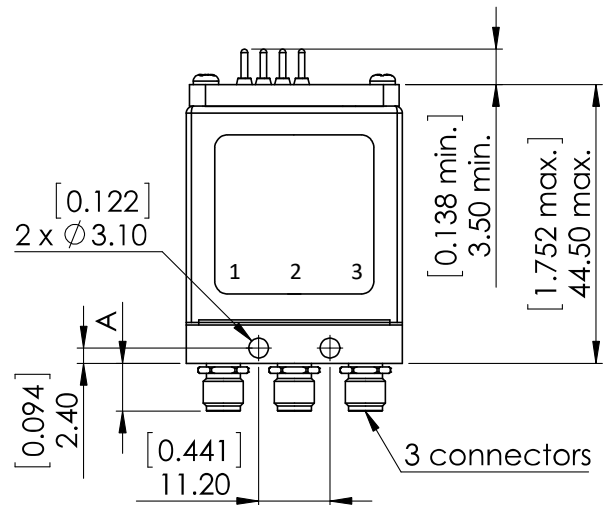
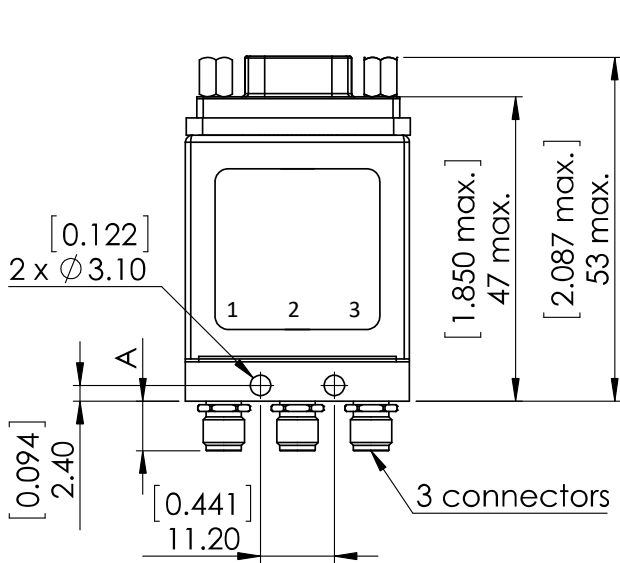
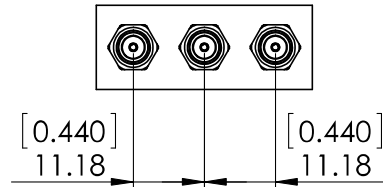

Connectors	A max mm [inches]
SMA up to 26.5GHz	7.7 [0.303]
SMA 2.9 up to 40GHz	6.7 [0.264]

SWITCH MODEL 2 : TERMINATED SPDT SWITCH

The-terminated SPDT switch is a single pole double throw switch. The unused ports are terminated into 50ohms. This switch is "break before make".

RF SCHEMATIC DIAGRAM

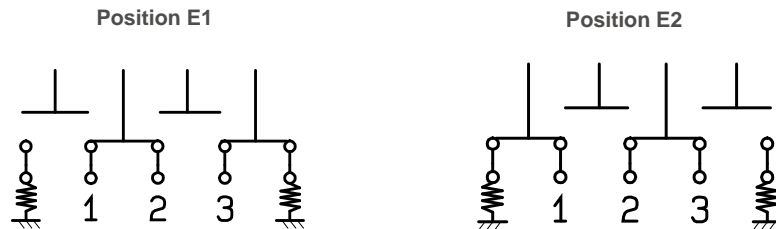

INDICATORS POSITION



Standard drive option "1" (Positive common):

- Connect pin +Vcc to supply
- Select desired RF path by applying ground to the corresponding "Close" pin (Ex: ground pin E1 to switch to position E1. RF path 1-2 closed and RF path 2-3 open).
- To open desired path and close the new RF path, connect ground to the corresponding "close" pin (Ex: ground pin E2 to open RF path 1-2 and close RF path 2-3)

TTL drive option "2"

- Connect pin GND to ground.
- Connect pin +Vcc to supply
- Select (close) desired RF path by applying TTL "High" to the corresponding "drive" pin (Ex: apply TTL "High" to pin E1 to switch to position E1. RF path 1-2 closed and RF path 2-3 open).
- To open desired path and close the new RF path, apply TTL "High" to the "drive" pin which corresponds to the desired RF path.
(Ex: apply TTL "High" to pin E2 to open RF path 1-2 and close RF path 2-3).

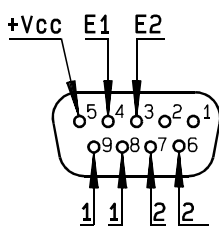

D-Sub connector

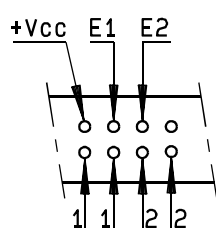

Solder pins

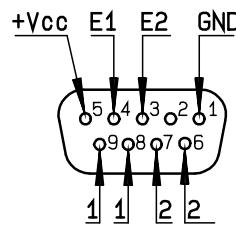

D-Sub connector

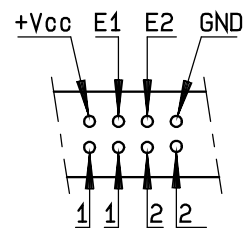

Solder pins

All dimensions are in millimetres [inches].

Model 26.5 GHz with D-Sub connector

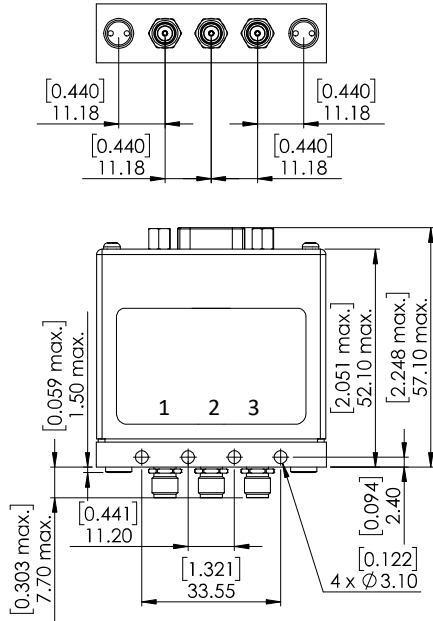

Model 26.5 GHz with solder pins

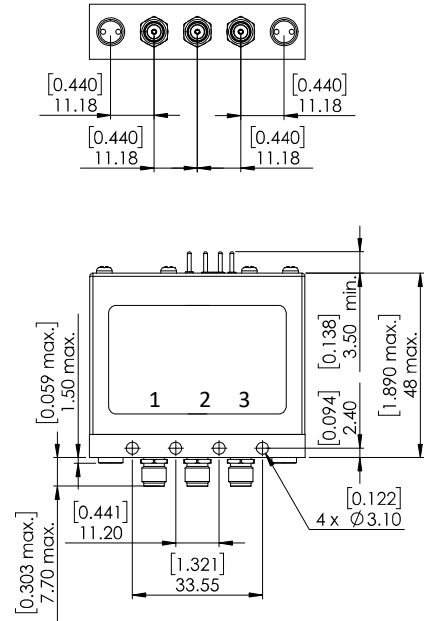

Model 40 GHz with D-Sub connector

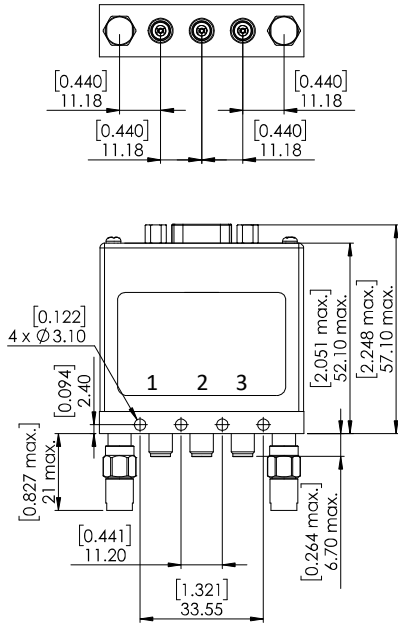

Model 40 GHz with solder pins

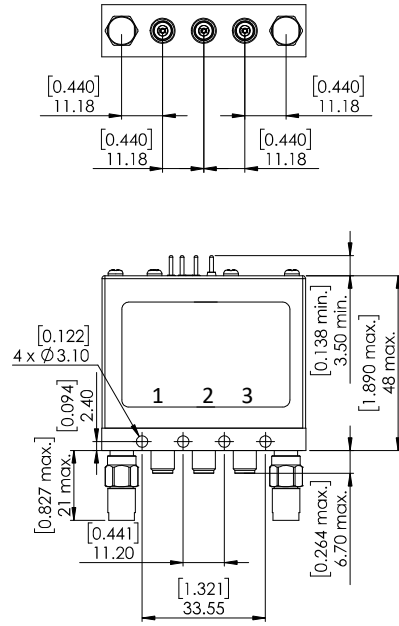

TOP view - D-Sub connector

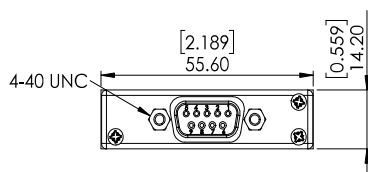

TOP view - solder pins

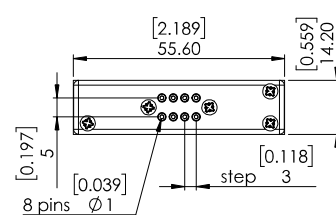

SWITCH MODEL 3 : TERMINATED 4 PORT BYPASS SWITCH

The terminated 4 port bypass switch can terminate into 50 ohms the device under test. These switches are "break before make".

RF SCHEMATIC DIAGRAM

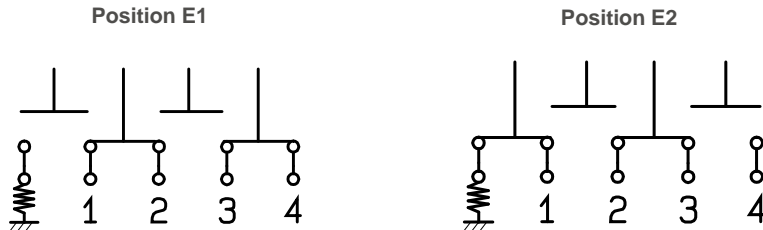

INDICATORS POSITION



Standard drive option "1" (Positive common):

- Connect pin +Vcc to supply
- Select desired RF path by applying ground to the corresponding "Close" pin (Ex: ground pin E1 to switch to position E1. RF path 1-2 closed and RF path 2-3 open).
- To open desired path and close the new RF path, connect ground to the corresponding "close" pin (Ex: ground pin E2 to open RF path 1-2 and close RF path 2-3)

TTL drive option "2"

- Connect pin GND to ground.
- Connect pin +Vcc to supply
- Select (close) desired RF path by applying TTL "High" to the corresponding "drive" pin (Ex: apply TTL "High" to pin E1 to switch to position E1. RF path 1-2 closed and RF path 2-3 open).
- To open desired path and close the new RF path, apply TTL "High" to the "drive" pin which corresponds to the desired RF path.
(Ex: apply TTL "High" to pin E2 to open RF path 1-2 and close RF path 2-3).

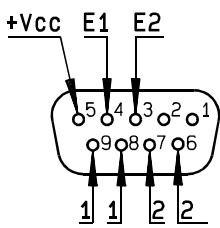

D-Sub connector

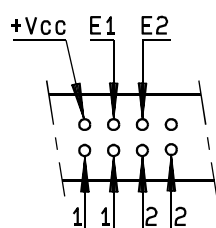

Solder pins

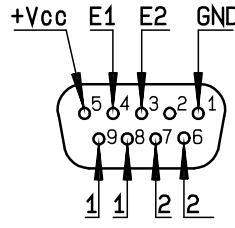

D-Sub connector

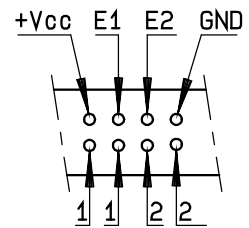

Solder pins

All dimensions are in millimetres [inches].

Model 26.5 GHz with D-Sub connector

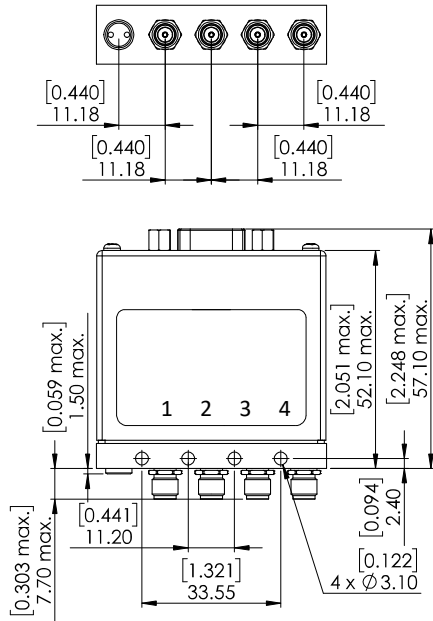

Model 26.5 GHz with solder pins

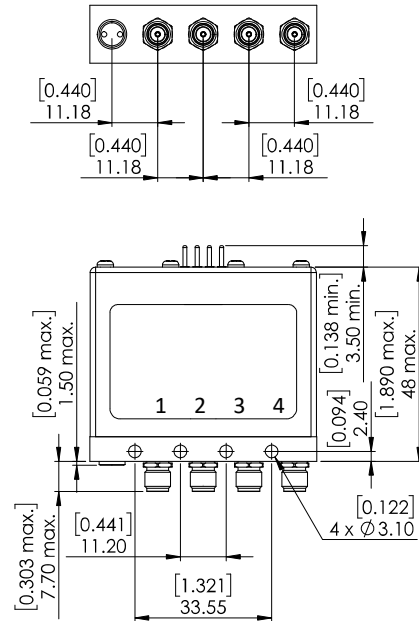

Model 40 GHz with D-Sub connector

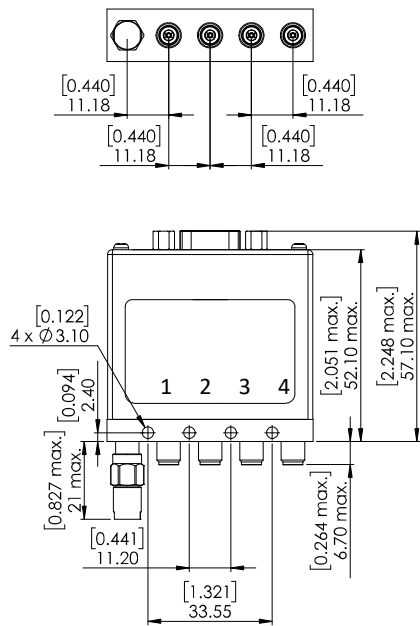

Model 40 GHz with solder pins

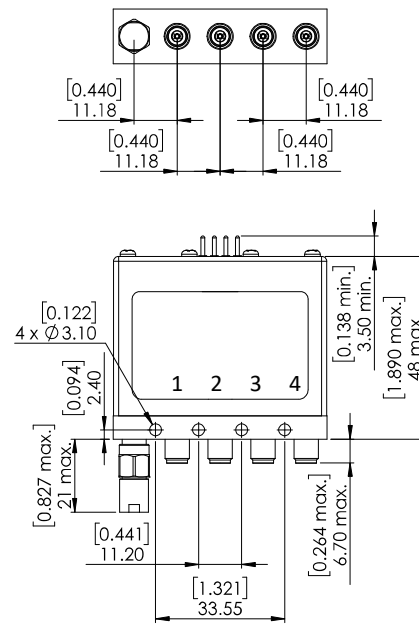

TOP view - D-Sub connector

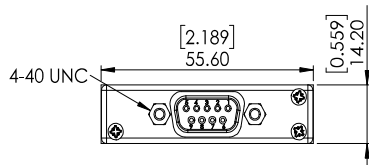

TOP view - solder pins

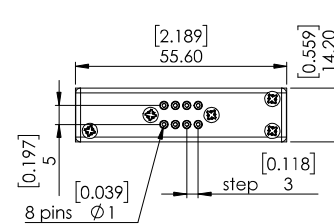

SWITCH MODEL 4 : NON TERMINATED 5 PORT DP3T SWITCH

The non-terminated 5 port DP3T switch can be used as SPDT with high power terminations, as a bypass switch. In this application, the fifth port can be terminated externally with a high power termination. These switches are "break before make".

RF SCHEMATIC DIAGRAM

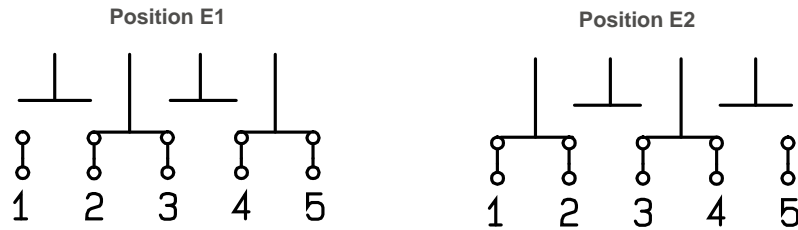

INDICATORS POSITION



Standard drive option "1" (Positive common):

- Connect pin +Vcc to supply
- Select desired RF path by applying ground to the corresponding "Close" pin (Ex: ground pin E1 to switch to position E1. RF path 2-3 and RF path 4-5 open).
- To open desired path and close the new RF path, connect ground to the corresponding "close" pin (Ex: ground pin E2 to open RF path 2-3 and 4-5 and close RF path 1-2 and 3-4)

TTL drive option "2"

- Connect pin GND to ground.
- Connect pin +Vcc to supply
- Select (close) desired RF path by applying TTL "High" to the corresponding "drive" pin (Ex: apply TTL "High" to pin E1 to switch to position E1. RF path 2-3 and RF path 4-5 closed and RF path 1-2 and 3-4 open).
- To open desired path and close the new RF path, apply TTL "High" to the "drive" pin which corresponds to the desired RF path.
(Ex: apply TTL "High" to pin E2 to open RF path 2-3 and 4-5 and close RF path 1-2 and 3-4).

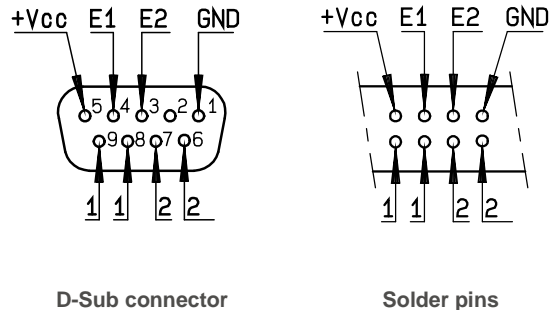
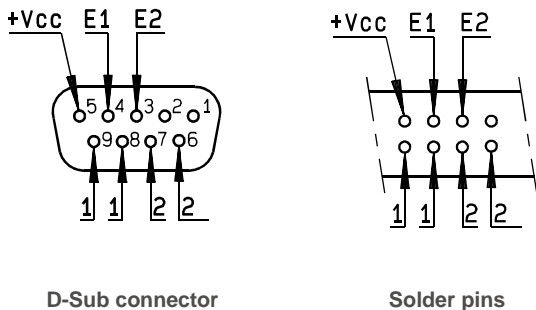

All dimensions are in millimetres [inches].

With D-Sub connector

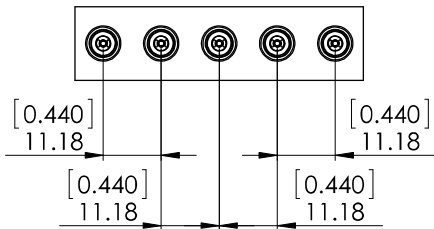

With solder pins

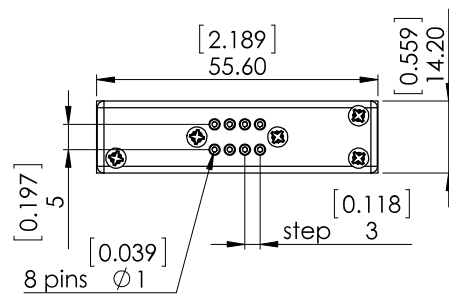
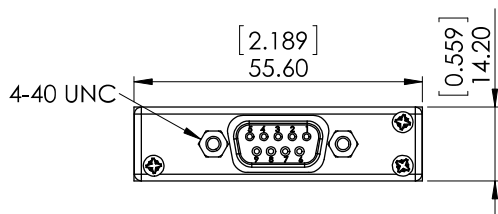
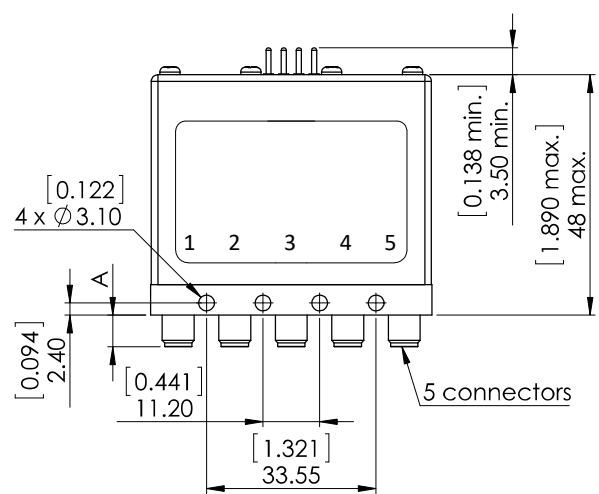
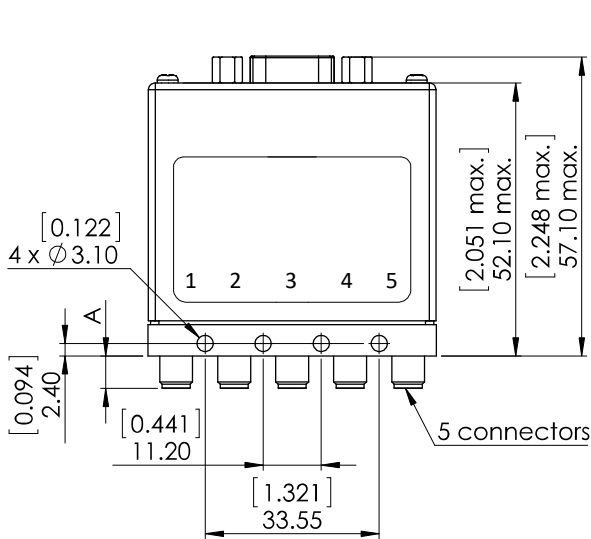
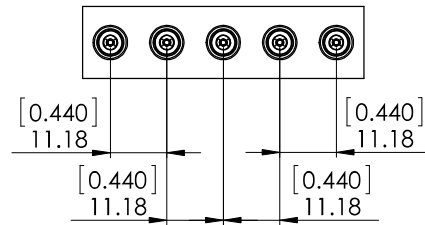

Connectors	A max mm [inches]
SMA up to 26.5GHz	7.7 [0.303]
SMA 2.9 up to 40GHz	6.7 [0.264]

PAGE 12/12	ISSUE 22-06-2018	SERIES DP3T/SPDT	PART NUMBER R595 XXX XXX
------------	------------------	------------------	--------------------------

POWER RATING CHART

This graph is based on the following conditions :

- Ambient temperature : + 25°C
- Sea level
- V.S.W.R. : 1 and cold switching

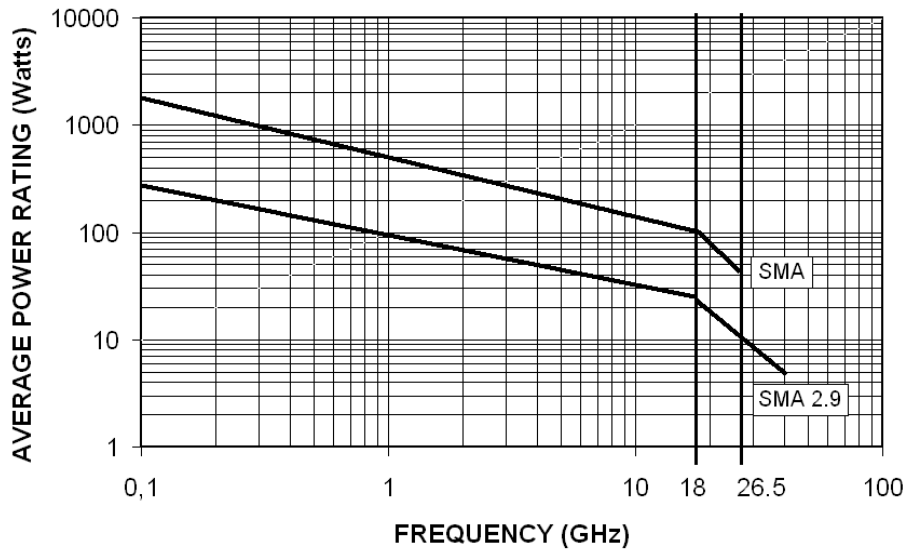

DERATING FACTOR VERSUS V.S.W.R.

The average power input must be reduced for load V.S.W.R. above 1.

