

N-channel 30 V, 2.15 mΩ typ., 120 A Power MOSFET in a TO-220 package

Datasheet - production data

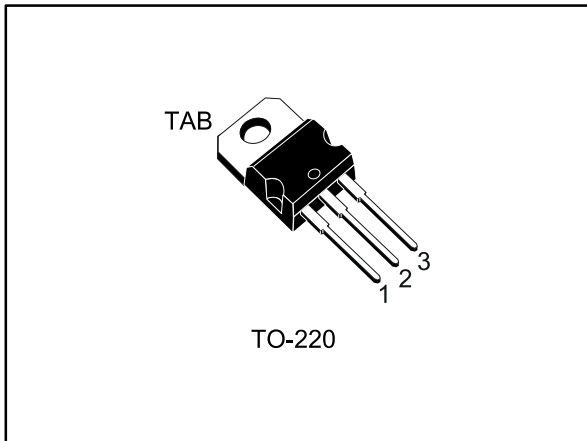
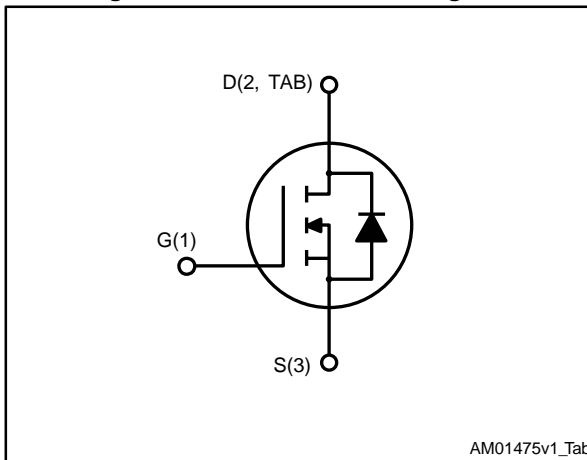

Figure 1: Internal schematic diagram



Features

Order code	V _{DS}	R _{DS(on)} max.	I _D	P _{TOT}
STP200N3LL	30 V	2.4 mΩ	120 A	176.5 W

- Very low on-resistance
- Very low gate charge
- High avalanche ruggedness
- Low gate drive power loss

Applications

- Switching applications

Description

This device is an N-channel Power MOSFET with very low R_{DS(on)} in all packages.

Table 1: Device summary

Order code	Marking	Package	Packing
STP200N3LL	200N3LL	TO-220	Tube

Contents

1	Electrical ratings	3
2	Electrical characteristics	4
	2.1 Electrical characteristics (curves).....	6
3	Test circuits	8
4	Package information	9
	4.1 TO-220 type A package information.....	10
5	Revision history	12

1 Electrical ratings

Table 2: Absolute maximum ratings

Symbol	Parameter	Value	Unit
V_{DS}	Drain-source voltage	30	V
V_{GS}	Gate-source voltage	± 20	
I_D	Drain current (continuous) at $T_{case} = 25\text{ }^{\circ}\text{C}$ (silicon limited)	200	A
$I_D^{(1)}$	Drain current (continuous) at $T_{case} = 25\text{ }^{\circ}\text{C}$	120	
I_D	Drain current (continuous) at $T_{case} = 100\text{ }^{\circ}\text{C}$	120	
$I_{DM}^{(2)}$	Drain current (pulsed)	480	
P_{TOT}	Total dissipation at $T_{case} = 25\text{ }^{\circ}\text{C}$	176.5	W
$E_{AS}^{(3)}$	Single pulse avalanche energy	300	mJ
T_{stg}	Storage temperature range	-55 to 175	$^{\circ}\text{C}$
T_j	Operating junction temperature range		

Notes:

- (1) Current is limited by package.
- (2) Pulse width is limited by safe operating area.
- (3) starting $T_j = 25\text{ }^{\circ}\text{C}$, $I_D = 68\text{ A}$

Table 3: Thermal data

Symbol	Parameter	Value	Unit
$R_{thj-case}$	Thermal resistance junction-case	0.85	$^{\circ}\text{C/W}$
$R_{thj-amb}$	Thermal resistance junction-ambient	62.5	

2 Electrical characteristics

($T_{\text{case}} = 25\text{ °C}$ unless otherwise specified)

Table 4: Static

Symbol	Parameter	Test conditions	Min.	Typ.	Max.	Unit
$V_{(\text{BR})\text{DSS}}$	Drain-source breakdown voltage	$V_{\text{GS}} = 0\text{ V}$, $I_{\text{D}} = 1\text{ mA}$	30			V
I_{DSS}	Zero gate voltage drain current	$V_{\text{GS}} = 0\text{ V}$, $V_{\text{DS}} = 30\text{ V}$			1	μA
		$V_{\text{GS}} = 0\text{ V}$, $V_{\text{DS}} = 30\text{ V}$, $T_{\text{case}} = 125\text{ °C}^{(1)}$			10	
I_{GSS}	Gate-body leakage current	$V_{\text{DS}} = 0\text{ V}$, $V_{\text{GS}} = \pm 20\text{ V}$			± 100	nA
$V_{\text{GS(th)}}$	Gate threshold voltage	$V_{\text{DS}} = V_{\text{GS}}$, $I_{\text{D}} = 250\text{ }\mu\text{A}$	1		2.5	V
$R_{\text{DS(on)}}$	Static drain-source on-resistance	$V_{\text{GS}} = 10\text{ V}$, $I_{\text{D}} = 60\text{ A}$		2.15	2.4	m Ω
		$V_{\text{GS}} = 4.5\text{ V}$, $I_{\text{D}} = 60\text{ A}$		2.5	3.1	

Notes:

⁽¹⁾Defined by design, not subject to production test.

Table 5: Dynamic

Symbol	Parameter	Test conditions	Min.	Typ.	Max.	Unit
C_{iss}	Input capacitance	$V_{\text{DS}} = 25\text{ V}$, $f = 1\text{ MHz}$, $V_{\text{GS}} = 0\text{ V}$	-	5200	-	pF
C_{oss}	Output capacitance		-	640	-	
C_{riss}	Reverse transfer capacitance		-	510	-	
Q_{g}	Total gate charge	$V_{\text{DD}} = 15\text{ V}$, $I_{\text{D}} = 120\text{ A}$, $V_{\text{GS}} = 4.5\text{ V}$ (see Figure 14: "Test circuit for gate charge behavior")	-	53	-	nC
Q_{gs}	Gate-source charge		-	13	-	
Q_{gd}	Gate-drain charge		-	27	-	
R_{G}	Intrinsic gate resistance	$f = 1\text{ MHz}$, $I_{\text{D}} = 0\text{ A}$, gate DC bias = 0 V , magnitude of alternative signal = 20 mV	-	1.1	-	Ω

Table 6: Switching times

Symbol	Parameter	Test conditions	Min.	Typ.	Max.	Unit
$t_{\text{d(on)}}$	Turn-on delay time	$V_{\text{DD}} = 15\text{ V}$, $I_{\text{D}} = 60\text{ A}$, $R_{\text{G}} = 4.7\text{ }\Omega$, $V_{\text{GS}} = 10\text{ V}$ (see Figure 13: "Test circuit for resistive load switching times" and Figure 18: "Switching time waveform")	-	18	-	ns
t_{r}	Rise time		-	183	-	
$t_{\text{d(off)}}$	Turn-off delay time		-	90	-	
t_{f}	Fall time		-	108	-	

Table 7: Source-drain diode

Symbol	Parameter	Test conditions	Min.	Typ.	Max.	Unit
$V_{SD}^{(1)}$	Forward on voltage	$V_{GS} = 0 \text{ V}$, $I_{SD} = 60 \text{ A}$	-		1.1	V
t_{rr}	Reverse recovery time	$I_{SD} = 120 \text{ A}$, $di/dt = 100 \text{ A}/\mu\text{s}$, $V_{DD} = 24 \text{ V}$ (see Figure 15: "Test circuit for inductive load switching and diode recovery times")	-	35		ns
Q_{rr}	Reverse recovery charge		-	34		nC
I_{RRM}	Reverse recovery current		-	2		A

Notes:

(1) Pulse test: pulse duration = 300 μs , duty cycle 1.5%.

2.1 Electrical characteristics (curves)

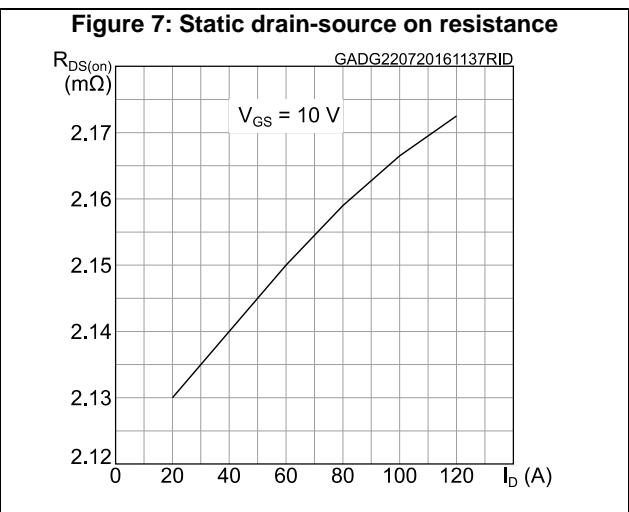
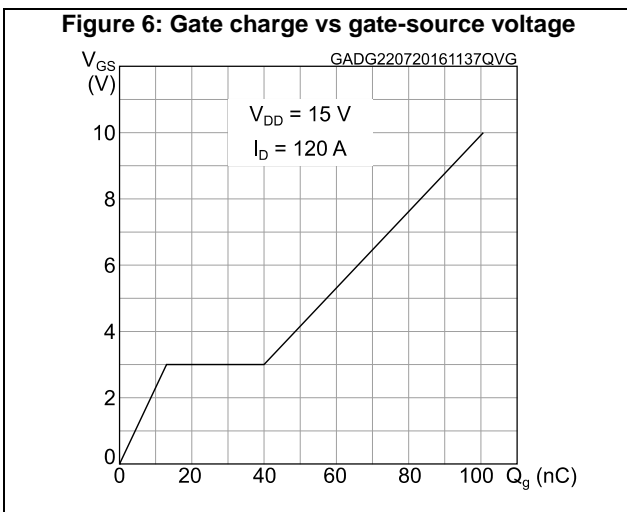
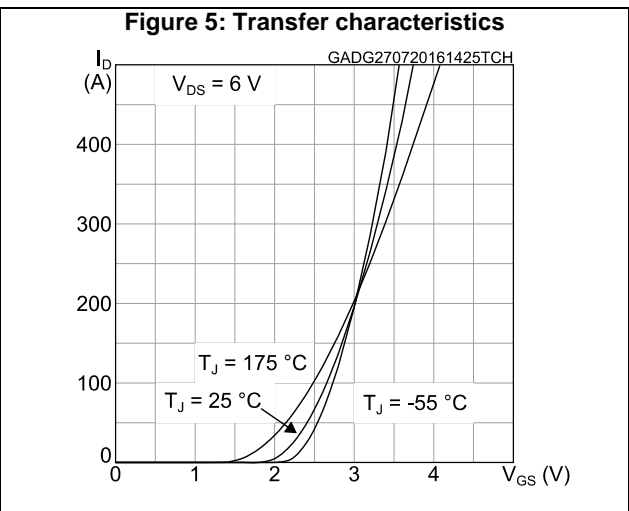
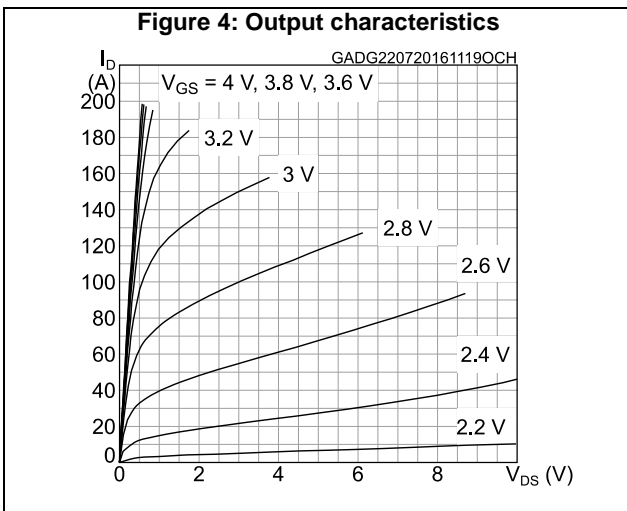
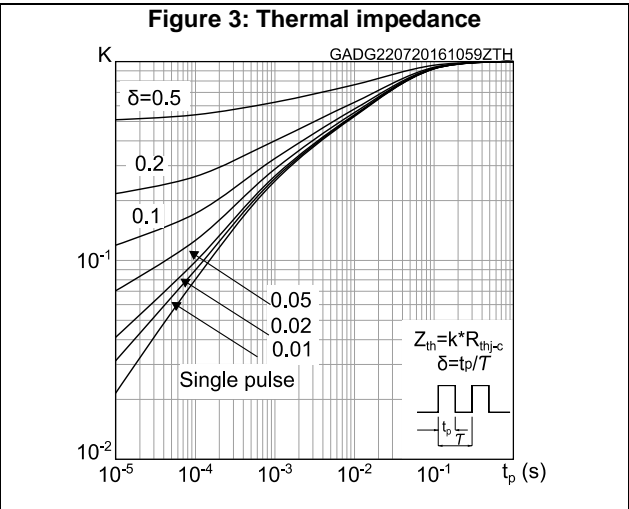
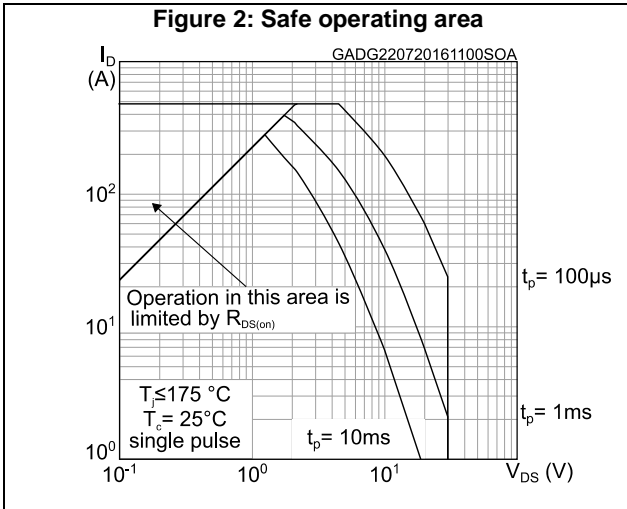

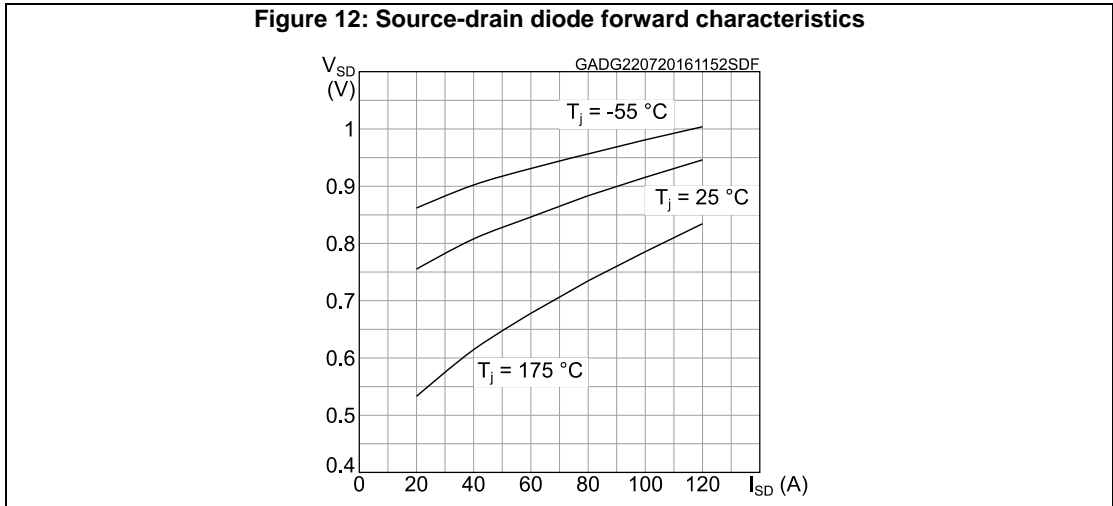
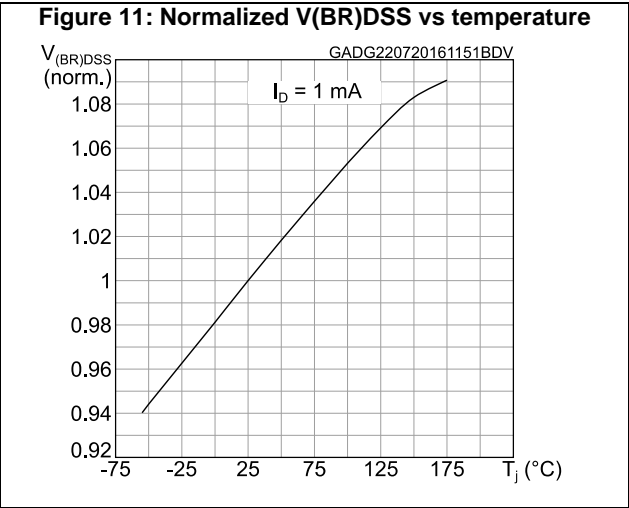
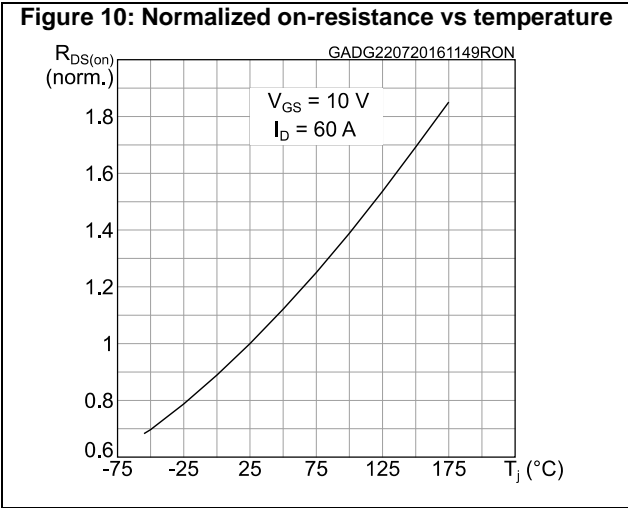
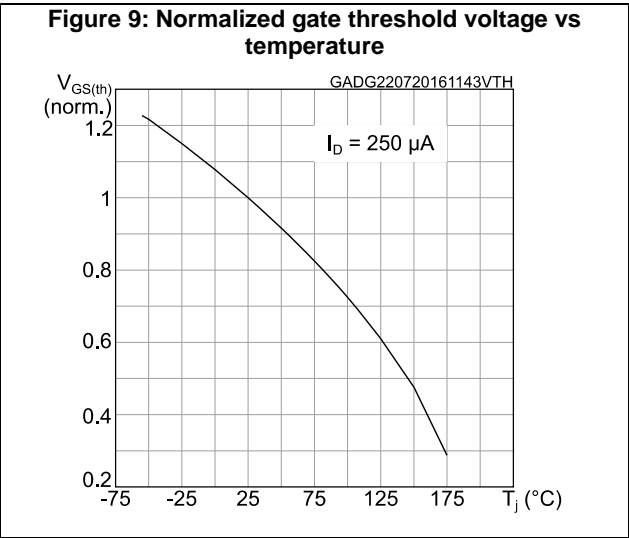
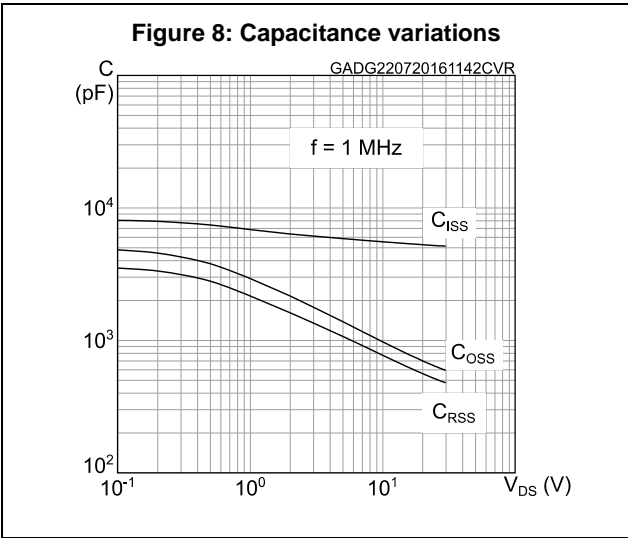

3 Test circuits

Figure 13: Test circuit for resistive load switching times



AM01468v1

Figure 14: Test circuit for gate charge behavior



AM01469v1

Figure 15: Test circuit for inductive load switching and diode recovery times

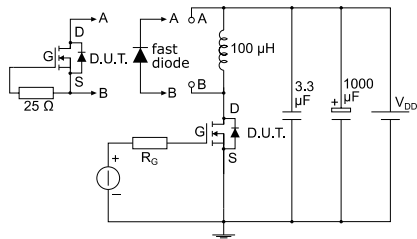

AM01470v1

Figure 16: Unclamped inductive load test circuit

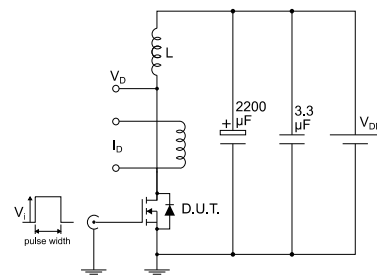

AM01471v1

Figure 17: Unclamped inductive waveform

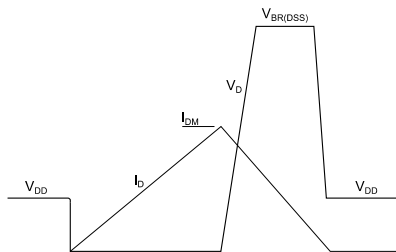

AM01472v1

Figure 18: Switching time waveform

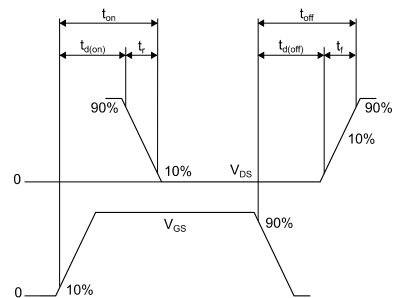

AM01473v1

4 Package information

In order to meet environmental requirements, ST offers these devices in different grades of ECOPACK® packages, depending on their level of environmental compliance. ECOPACK® specifications, grade definitions and product status are available at: www.st.com. ECOPACK® is an ST trademark.

4.1 TO-220 type A package information

Figure 19: TO-220 type A package outline

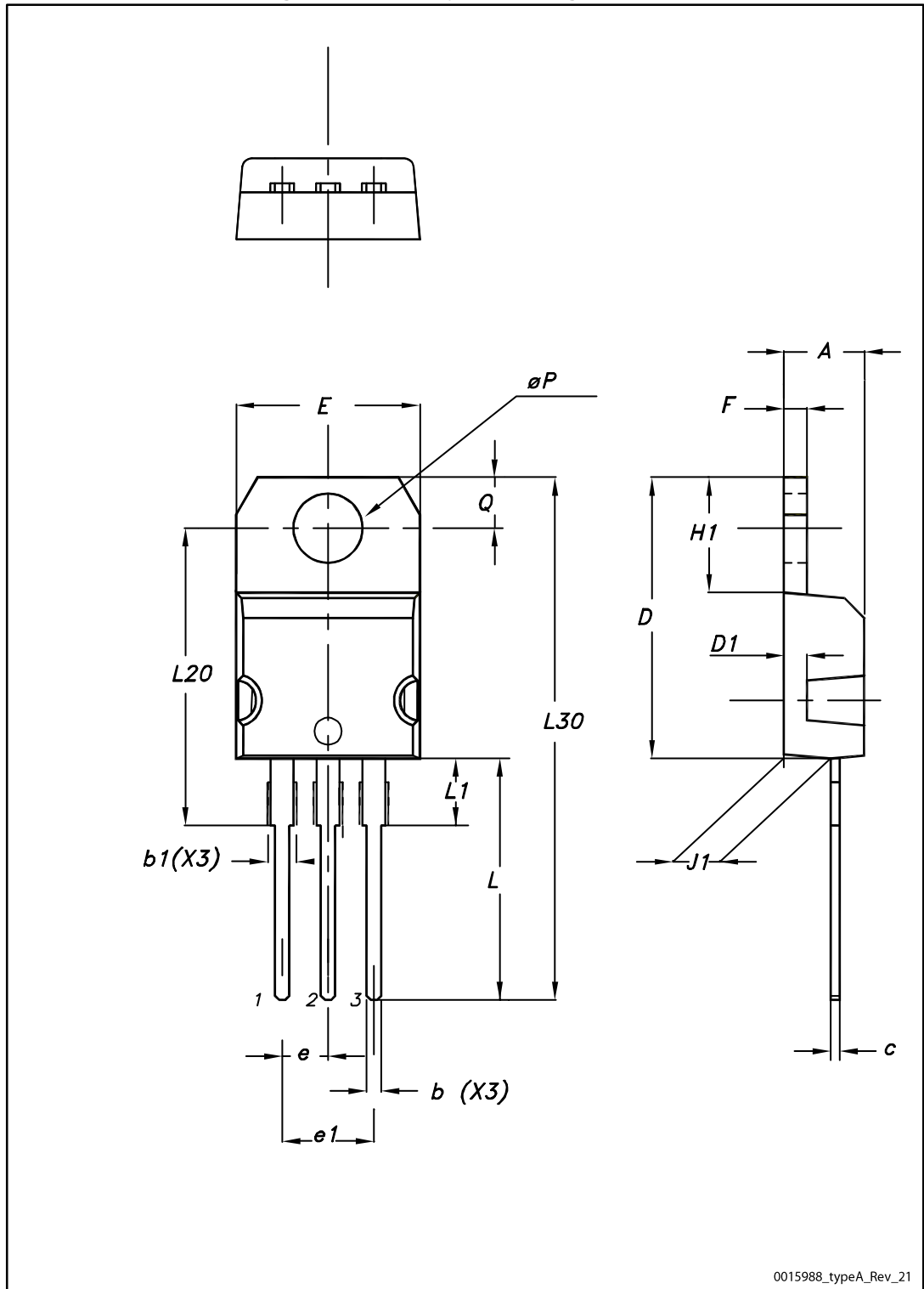

Table 8: TO-220 type A mechanical data

Dim.	mm		
	Min.	Typ.	Max.
A	4.40		4.60
b	0.61		0.88
b1	1.14		1.55
c	0.48		0.70
D	15.25		15.75
D1		1.27	
E	10.00		10.40
e	2.40		2.70
e1	4.95		5.15
F	1.23		1.32
H1	6.20		6.60
J1	2.40		2.72
L	13.00		14.00
L1	3.50		3.93
L20		16.40	
L30		28.90	
øP	3.75		3.85
Q	2.65		2.95

5 Revision history

Table 9: Document revision history

Date	Revision	Changes
14-Dec-2015	1	First release.
27-Jul-2016	2	Document status promoted from preliminary to production data. Updated <i>Section 2: "Electrical ratings"</i> and <i>Section 3: "Electrical characteristics"</i> . Added <i>Section 3.1: "Electrical characteristics (curves)"</i> . Minor text changes.

IMPORTANT NOTICE – PLEASE READ CAREFULLY

STMicroelectronics NV and its subsidiaries ("ST") reserve the right to make changes, corrections, enhancements, modifications, and improvements to ST products and/or to this document at any time without notice. Purchasers should obtain the latest relevant information on ST products before placing orders. ST products are sold pursuant to ST's terms and conditions of sale in place at the time of order acknowledgement.

Purchasers are solely responsible for the choice, selection, and use of ST products and ST assumes no liability for application assistance or the design of Purchasers' products.

No license, express or implied, to any intellectual property right is granted by ST herein.

Resale of ST products with provisions different from the information set forth herein shall void any warranty granted by ST for such product.

ST and the ST logo are trademarks of ST. All other product or service names are the property of their respective owners.

Information in this document supersedes and replaces information previously supplied in any prior versions of this document.

© 2016 STMicroelectronics – All rights reserved