



Features

- No backlash
- Compact - requires minimal panel space (22.2 mm diameter requirement)
- For use with precision potentiometers or other rotating devices, up to 15 turns
- Designed for metal shaft
- High Force "Click Brake"
- Available in three versions - black on satin chrome background, white on black background or satin body/black dial
- RoHS compliant*

H-22 Turns-Counting Dial

Mechanical and Physical Characteristics

Number of Turns	0 to 15
Dial Divisions	50 per turn
Readability - Over 10 Turns2 parts in 1000
Torque With Brake Engaged	6.95 oz-in. (500 g-cm) minimum
Markings	Black on satin chrome background or white on black background
Locking Brake	Yes
Weight	15 grams (0.53 oz.)
Set Screw	UNC N2-56, one included
Set Screw Tightening Torque	16.94 N-cm (1.5 lbs.-in.) minimum
Hex Key Size	0.05 in. hex

Shaft and Bushing Requirements

Shaft Diameter Requirements	Refer to chart below
Shaft Extension Beyond Panel	18.1 mm (0.712 in.) minimum 22.2 mm (0.875 in.) maximum
Bushing Extension Beyond Panel	9.53 mm (0.375 in.) maximum

H-22 MOUNTING INSTRUCTIONS

1. Insert potentiometer in panel.
2. Install anti-rotation device using hardware supplied with potentiometer.
3. Turn potentiometer shaft counterclockwise to minimum resistance or voltage ratio.
4. Set the dial to "0.0" and brake on.
5. Insert the dial on the potentiometer shaft lightly against the panel.
6. Tighten set screw to potentiometer shaft.

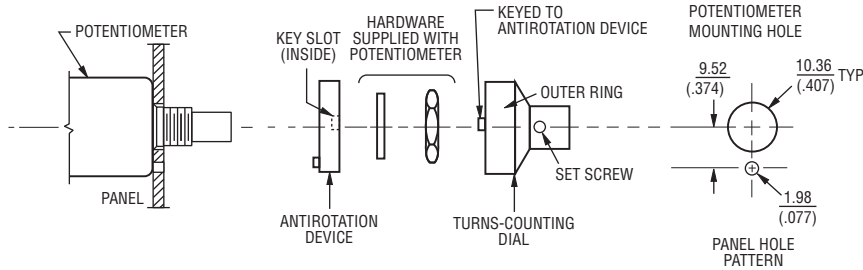

Dimensional Drawings

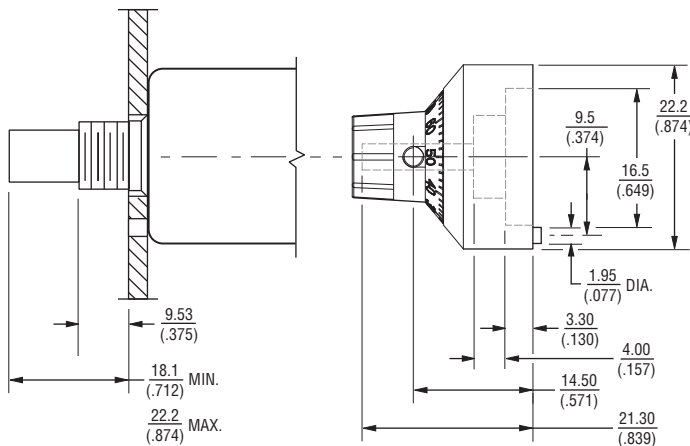

How To Order

Part Number	Accepts Shaft Diameter	Finish
H-22-6A	6.35 (.250)	Satin chrome
H-22-6M	6.0 (.236)	Satin chrome
H-22-3A	3.17 (.124)	Satin chrome
H-22-6A-B	6.35 (.250)	All black
H-22-6A-SB	6.35 (.250)	Satin body/ black dial

DIMENSIONS: $\frac{\text{MM}}{\text{(INCHES)}}$

REV. 10/12

*RoHS Directive 2002/95/EC Jan. 27, 2003 including annex and RoHS Recast 2011/65/EU June 8, 2011.

Specifications are subject to change without notice.

Customers should verify actual device performance in their specific applications.