

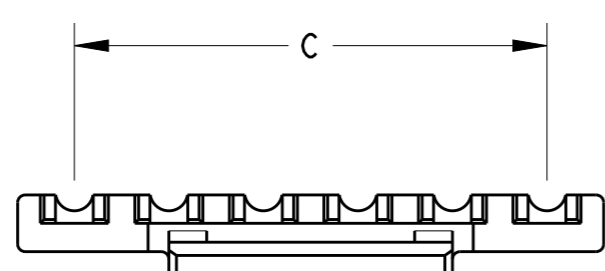

THIS DRAWING IS UNPUBLISHED. RELEASED FOR PUBLICATION
 © COPYRIGHT - BY - TE CONNECTIVITY ALL RIGHTS RESERVED.

LOC	DIST	REVISIONS					
-	-	P	LTR	DESCRIPTION	DATE	DWN	APVD
			A	INITIAL RELEASE	21FEB2012	ZHJ	E. K
			B	ADD 4P/7P PRODUCT	28MAY2013	HJ. Z	YH. M

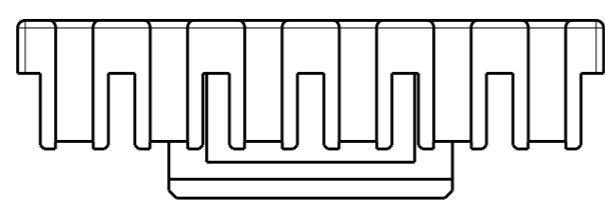
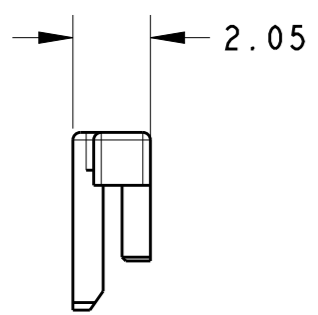
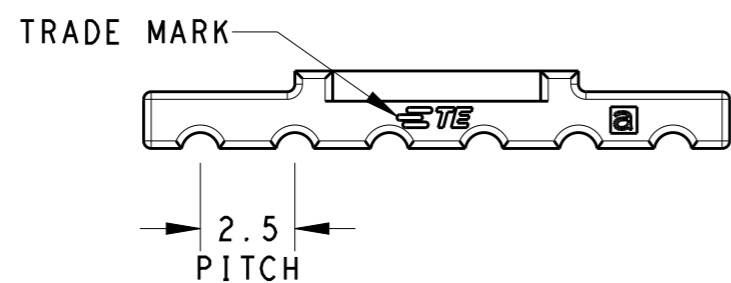
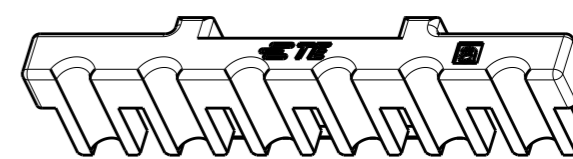
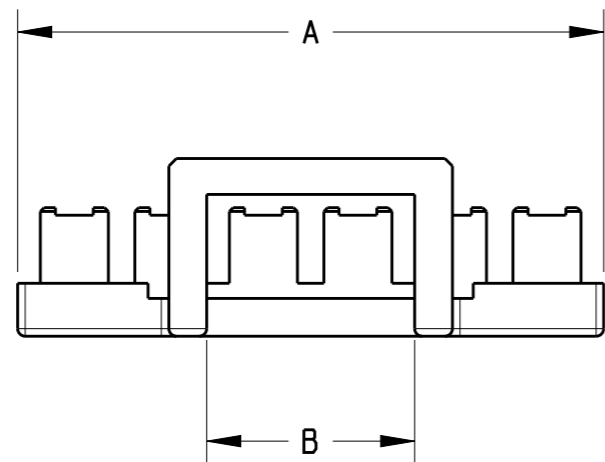

*The part is assembled with plug housing: X-1971793-X

17.5	8.4	20.5	8	8-1971794-1
15	8.4	18	7	7-1971794-1
12.5	5.5	15.5	6	6-1971794-1
10	3.3	13	5	5-1971794-1
7.5	3.7	10.5	4	4-1971794-1
5	2.5	8	3	3-1971794-1
2.5	2.4	5.5	2	2-1971794-1
C	B	A	POS	P/N

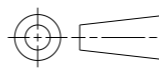
THIS DRAWING IS A CONTROLLED DOCUMENT.		DWN HJ.M 28MAY2013	 TE Connectivity TPA, 2.5 PITCH NEXT GENERATION GI CONNECTOR	
DIMENSIONS: mm		CHK HJ.M 28MAY2013		
		APVD HJ.M 28MAY2013		
TOLERANCES UNLESS OTHERWISE SPECIFIED: 0 PLC ±- 1 PLC ±0.3 2 PLC ±0.13 3 PLC ±0.013 4 PLC ±0.0001 ANGLES ±-		PRODUCT SPEC 108-106077		
MATERIAL PA66 GF	FINISH -	APPLICATION SPEC -	WEIGHT -	NAME TPA, 2.5 PITCH NEXT GENERATION GI CONNECTOR
Customer Drawing		SIZE A3	CAGE CODE -	DRAWING NO C-1971794
		RESTRICTED TO -	SCALE /	SHEET 1 OF 1 REV B