

Eveready 1250

D
SUPER HEAVY DUTY



Industry Standard Dimensions

mm (inches)

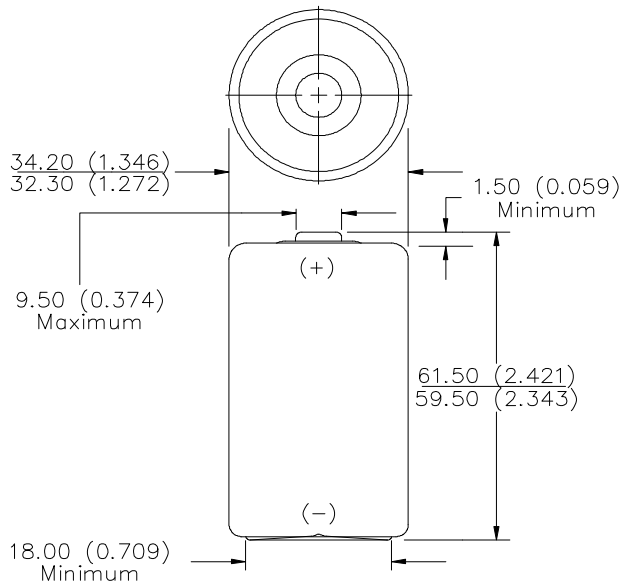

Chemical System: Zinc-Manganese Dioxide (Zn/MnO₂)
(No Added Mercury or Cadmium)

Designation: ANSI-13D, IEC-R20

Battery Voltage: 1.5 Volts

Operating Temp: -18°C to 55°C (0°F to 130°F)

Average Weight: 89.0 grams (3.1 oz.)

Volume: 53 cubic centimeters (3.2 cubic inch)

Average Capacity: 8,000 mAh to 0.8 volts
(Rated at 25 mA continuous at 21°C)

Cell: One No. 50 (size "D")

Jacket: Metal

TYPICAL PERCENT SERVICE
3.9 ohm - 4 hours/day to 0.75 volts

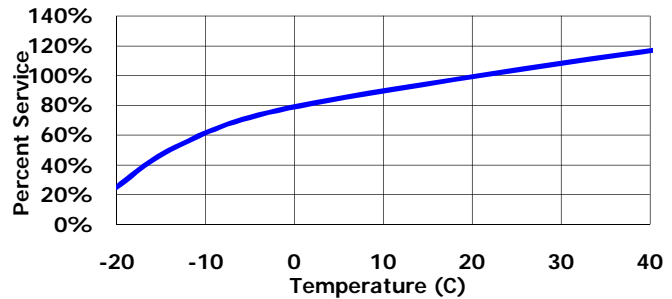

CONSTANT RESISTANCE PERFORMANCE
Typical Service

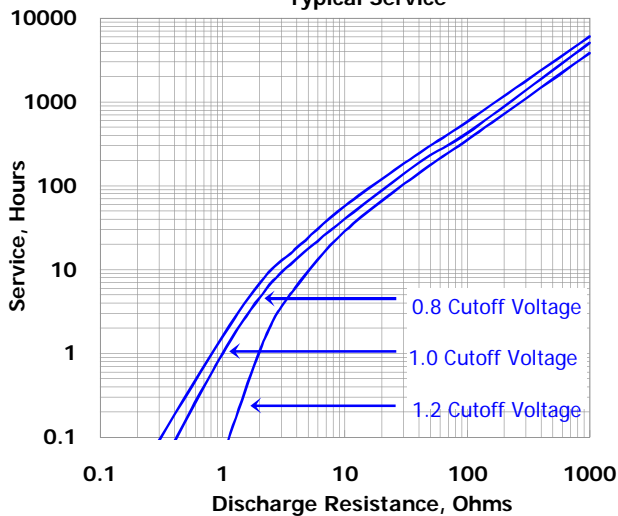

CONSTANT CURRENT DISCHARGE
Typical Service

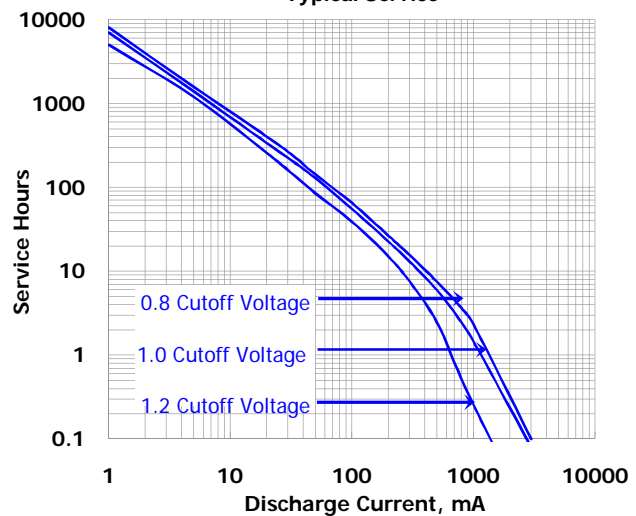

Important Notice

This data sheet contains information specific to batteries manufactured at the time of its publication.

Contents herein do not constitute a warranty.

Copyright © Eveready Battery Co. - All rights reserved

Eveready 1250

Industry Standard Tests (21° C)

RADIO
10 ohm - 4 hours/day

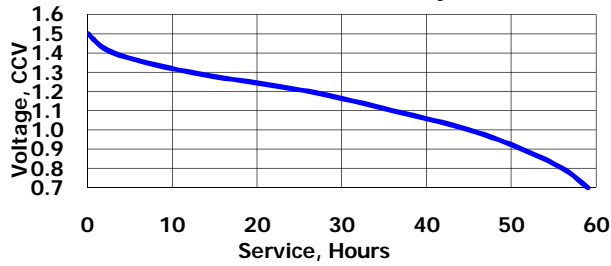

PORTABLE STEREO
3.9 ohm - 1 hr/day

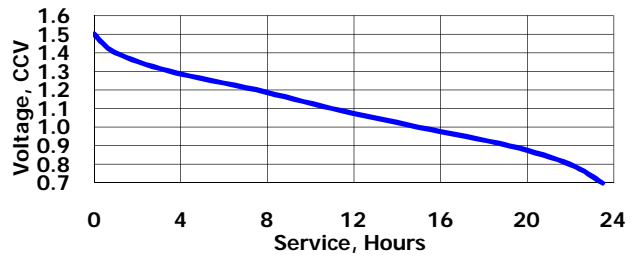

TOY
2.2 ohm - 1 hr/day

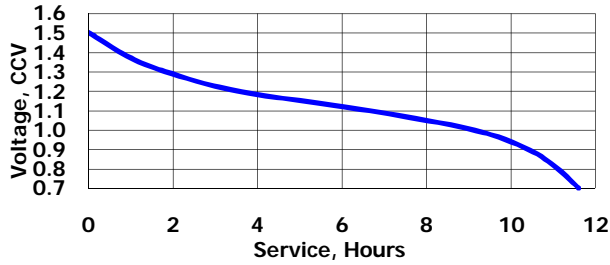

PORTABLE LIGHT
2.2 ohms - 4 min/hour 8 hours/day

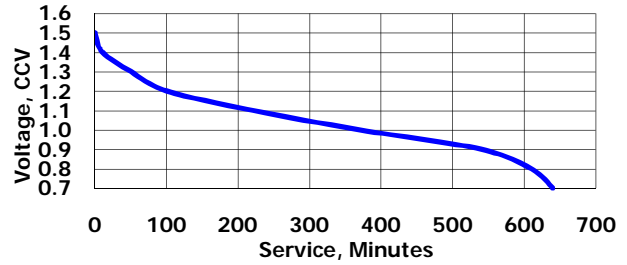

Important Notice

This data sheet contains information specific to batteries manufactured at the time of its publication.

Contents herein do not constitute a warranty.

Copyright © Eveready Battery Co. - All rights reserved