

## FEATURES

- Simultaneously Monitors Three Supplies  
 LTC1326: 5V, 3.3V and ADJ  
 LTC1326-2.5: 2.5V, 3.3V and ADJ
- Guaranteed Threshold Accuracy:  $\pm 0.75\%$
- Low Supply Current: 20 $\mu$ A
- Internal Reset Time Delay: 200ms
- Manual Push-Button Reset Input
- Active Low and Active High Reset Outputs
- Active Low "Soft" Reset Output
- Power Supply Glitch Immunity
- Guaranteed  $\overline{\text{RESET}}$  for  $V_{\text{CC3}} \geq 1\text{V}$  or  $V_{\text{CC5}} \geq 1\text{V}$  or  $V_{\text{CC25}} \geq 1\text{V}$
- 8-Pin SO and MSOP Packages

## APPLICATIONS

- Desktop Computers
- Notebook Computers
- Intelligent Instruments
- Portable Battery-Powered Equipment

## DESCRIPTION

The LTC<sup>®</sup>1326/LTC1326-2.5 are triple supply monitors intended for systems with multiple supply voltages. They provide micropower operation, small size and high accuracy supply monitoring.

Tight 0.75% threshold accuracy and glitch immunity ensure reliable reset operation without false triggering. The 20 $\mu$ A typical supply current makes the LTC1326/LTC1326-2.5 ideal for power-conscious systems.

The  $\overline{\text{RST}}$  output is guaranteed to be in the correct state for  $V_{\text{CC3}}$ ,  $V_{\text{CC5}}$  or  $V_{\text{CC25}}$  down to 1V. The LTC1326/LTC1326-2.5 can be configured to monitor one, two or three inputs, depending on system requirements.

A manual push-button reset input provides the ability to generate a very narrow "soft" reset pulse (100 $\mu$ s typ) or a 200ms reset pulse equivalent to a power-on reset. Both  $\overline{\text{SRST}}$  and  $\overline{\text{RST}}$  outputs are open-drain and can be OR-tied with other reset sources.

LT, LT, LTC and LTM are registered trademarks of Linear Technology Corporation. All other trademarks are the property of their respective owners. Protected by U.S. Patents, including 4843302.

## TYPICAL APPLICATION

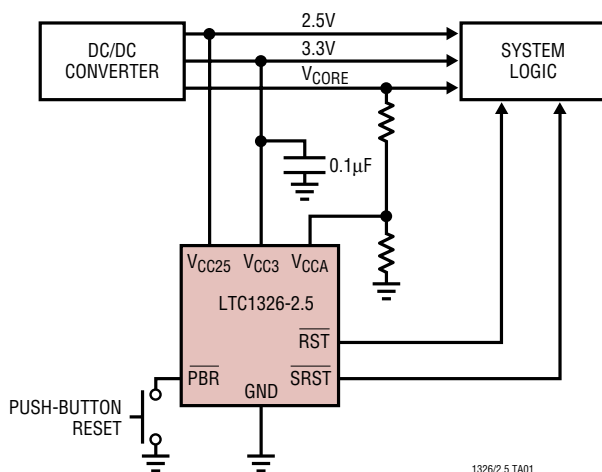

$\overline{\text{RST}}$  Output Voltage vs Supply Voltage (LTC1326-2.5)

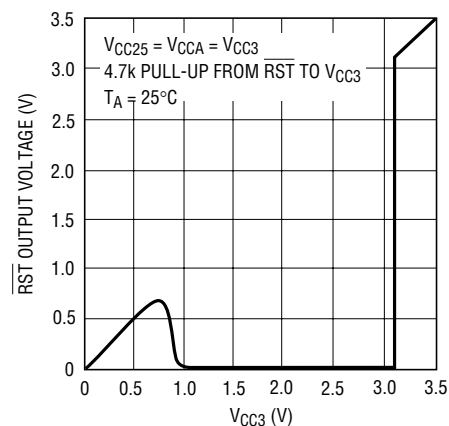

1326/2.5 TA02

# LTC1326/LTC1326-2.5

## ABSOLUTE MAXIMUM RATINGS (Notes 1, 2)

### Terminal Voltage

$V_{CC3}, V_{CC5}, V_{CC25}, V_{CCA}$ .....	-0.5V to 7V
$\overline{RST}, \overline{SRST}$ .....	-0.5V to 7V
$\overline{RST}$ .....	-0.5V to ( $V_{CC3} + 0.3V$ )
$\overline{PBR}$ .....	-7V to 7V

### Operating Temperature Range

LTC1326C/LTC1326C-2.5 .....	0°C to 70°C
LTC1326I/LTC1326I-2.5 .....	-40°C to 85°C
Storage Temperature Range .....	-65°C to 150°C
Lead Temperature (Soldering, 10 sec) .....	300°C

## PACKAGE/ORDER INFORMATION

ORDER PART NUMBER	MS8 PART NUMBER	ORDER PART NUMBER	S8 PART NUMBER
LTC1326CMS8 LTC1326IMS8	LTBA LTUH	LTC1326CS8 LTC1326IS8	1326 1326I
ORDER PART NUMBER	MS8 PART NUMBER	ORDER PART NUMBER	S8 PART NUMBER
LTC1326CMS8-2.5 LTC1326IMS8-2.5	LTEK LTUJ	LTC1326CS8-2.5 LTC1326IS8-2.5	132625 326I25
<b>Order Options</b> Tape and Reel: Add #TR Lead Free: Add #PBF Lead Free Tape and Reel: Add #TRPBF Lead Free Part Marking: <a href="http://www.linear.com/leadfree/">http://www.linear.com/leadfree/</a>			

Consult factory for parts specified with wider operating temperature ranges.

**ELECTRICAL CHARACTERISTICS** The ● denotes the specifications which apply over the full operating temperature range, otherwise specifications are at  $T_A = 25^\circ\text{C}$ .  $V_{CC3} = 3.3\text{V}$ ,  $V_{CC5} = 5\text{V}$  (for LTC1326),  $V_{CC25} = 2.5\text{V}$  (for LTC1326-2.5),  $V_{CCA} = V_{CC3}$ ,  $T_A = 25^\circ\text{C}$  unless otherwise noted.

SYMBOL	PARAMETER	CONDITIONS	MIN	TYP	MAX	UNITS	
$V_{RT3}$	Reset Threshold $V_{CC3}$	$0^\circ\text{C} \leq T_A \leq 70^\circ\text{C}$	● 3.094	3.118	3.135	V	
		$-40^\circ\text{C} \leq T_A \leq 85^\circ\text{C}$	● 3.052	3.118	3.143	V	
$V_{RT5}$	Reset Threshold $V_{CC5}$ (LTC1326)	$0^\circ\text{C} \leq T_A \leq 70^\circ\text{C}$	● 4.687	4.725	4.750	V	
		$-40^\circ\text{C} \leq T_A \leq 85^\circ\text{C}$	● 4.625	4.725	4.762	V	
$V_{RT25}$	Reset Threshold $V_{CC25}$ (LTC1326-2.5)	$0^\circ\text{C} \leq T_A \leq 70^\circ\text{C}$	● 2.344	2.363	2.375	V	
		$-40^\circ\text{C} \leq T_A \leq 85^\circ\text{C}$	● 2.312	2.363	2.381	V	
$V_{RTA}$	Reset Threshold $V_{CCA}$	$0^\circ\text{C} \leq T_A \leq 70^\circ\text{C}$	● 0.992	1.000	1.007	V	
		$-40^\circ\text{C} \leq T_A \leq 85^\circ\text{C}$	● 0.980	1.000	1.007	V	
$V_{CC}$	$V_{CC3}$ Operating Voltage	$\overline{\text{RST}}$ in Correct Logic State	● 1		7	V	
$I_{VCC3}$	$V_{CC3}$ Supply Current	$\overline{\text{PBR}} = V_{CC3}$	●	20	40	$\mu\text{A}$	
$I_{VCC5}$	$V_{CC5}$ Input Current (LTC1326)	$V_{CC5} = 5\text{V}$	●	4	10	$\mu\text{A}$	
$I_{VCC25}$	$V_{CC25}$ Input Current (LTC1326-2.5)	$V_{CC25} = 2.5\text{V}$	●	2.8	7	$\mu\text{A}$	
$I_{VCCA}$	$V_{CCA}$ Input Current	$V_{CCA} = 1\text{V}$	●	-15	0	nA	
$t_{\text{RST}}$	Reset Pulse Width	$\overline{\text{RST}}$ Low with 10k $\Omega$ Pull-Up to $V_{CC3}$	●				
		$0^\circ\text{C} \leq T_A \leq 70^\circ\text{C}$	● 140	200	280	ms	
		$-40^\circ\text{C} \leq T_A \leq 85^\circ\text{C}$	● 140	200	300	ms	
$t_{\text{SRST}}$	Soft Reset Pulse Width	$\overline{\text{SRST}}$ Low with 10k $\Omega$ Pull-Up to $V_{CC3}$	●	50	100	200	$\mu\text{s}$
$t_{\text{UV}}$	$V_{CC}$ Undervoltage Detect to $\overline{\text{RST}}$	$V_{CC25}$ , $V_{CC3}$ or $V_{CCA}$ Less Than Reset Threshold $V_{RT}$ by More Than 1%		13		$\mu\text{s}$	
$I_{\text{PBR}}$	$\overline{\text{PBR}}$ Pull-Up Current	$\overline{\text{PBR}} = 0\text{V}$	●				
		$0^\circ\text{C} \leq T_A \leq 70^\circ\text{C}$	● 3	7	10	$\mu\text{A}$	
		$-40^\circ\text{C} \leq T_A \leq 85^\circ\text{C}$	● 3	7	15	$\mu\text{A}$	
$V_{\text{IL}}$	$\overline{\text{PBR}}$ , $\overline{\text{RST}}$ Input Low Voltage		●		0.8	V	
$V_{\text{IH}}$	$\overline{\text{PBR}}$ , $\overline{\text{RST}}$ Input High Voltage		●	2		V	
$t_{\text{PW}}$	$\overline{\text{PBR}}$ Min Pulse Width		●	40		ns	
$t_{\text{DB}}$	$\overline{\text{PBR}}$ Debounce	Deassertion of $\overline{\text{PBR}}$ Input to $\overline{\text{SRST}}$ Output ( $\overline{\text{PBR}}$ Pulse Width = 1 $\mu\text{s}$ )	●	20	35	ms	
$t_{\text{PB}}$	$\overline{\text{PBR}}$ Assertion Time for Transition from Soft to Hard Reset Mode	$\overline{\text{PBR}}$ Held Less Than $V_{\text{IL}}$	●				
		$0^\circ\text{C} \leq T_A \leq 70^\circ\text{C}$	● 1.4	2.0	2.8	s	
		$-40^\circ\text{C} \leq T_A \leq 85^\circ\text{C}$	● 1.4	2.0	3.0	s	
$V_{\text{OL}}$	RST Output Voltage Low	$I_{\text{SINK}} = 5\text{mA}$	●	0.15	0.4	V	
		$I_{\text{SINK}} = 100\mu\text{A}$ , $0^\circ\text{C} \leq T_A \leq 70^\circ\text{C}$	$V_{CC3} = 1\text{V}$ , $V_{CC5} = 0\text{V}$	●	0.05	0.4	V
			$V_{CC3} = 0\text{V}$ , $V_{CC5} = 1\text{V}$	●	0.05	0.4	V
			$V_{CC3} = 1\text{V}$ , $V_{CC5} = 1\text{V}$	●	0.05	0.4	V
		$I_{\text{SINK}} = 100\mu\text{A}$ , $-40^\circ\text{C} \leq T_A \leq 85^\circ\text{C}$	$V_{CC3} = 1.1\text{V}$ , $V_{CC5} = 0\text{V}$	●	0.05	0.4	V
			$V_{CC3} = 0\text{V}$ , $V_{CC5} = 1.1\text{V}$	●	0.05	0.4	V
			$V_{CC3} = 1.1\text{V}$ , $V_{CC5} = 1.1\text{V}$	●	0.05	0.4	V
$I_{\text{SINK}} = 100\mu\text{A}$ , $0^\circ\text{C} \leq T_A \leq 70^\circ\text{C}$	$V_{CC3} = 1\text{V}$ , $V_{CC25} = 0\text{V}$	●	0.05	0.4	V		
	$V_{CC3} = 0\text{V}$ , $V_{CC25} = 1\text{V}$	●	0.05	0.4	V		
	$V_{CC3} = 1\text{V}$ , $V_{CC25} = 1\text{V}$	●	0.05	0.4	V		
$I_{\text{SINK}} = 100\mu\text{A}$ , $-40^\circ\text{C} \leq T_A \leq 85^\circ\text{C}$	$V_{CC3} = 1.1\text{V}$ , $V_{CC25} = 0\text{V}$	●	0.05	0.4	V		
	$V_{CC3} = 0\text{V}$ , $V_{CC25} = 1.1\text{V}$	●	0.05	0.4	V		
	$V_{CC3} = 1.1\text{V}$ , $V_{CC25} = 1.1\text{V}$	●	0.05	0.4	V		
	$\overline{\text{SRST}}$ Output Voltage Low	$I_{\text{SINK}} = 2.5\text{mA}$	●	0.15	0.4	V	
	RST Output Voltage Low	$I_{\text{SINK}} = 2.5\text{mA}$	●	0.15	0.4	V	

## ELECTRICAL CHARACTERISTICS

The ● denotes the specifications which apply over the full operating temperature range, otherwise specifications are at  $T_A = 25^\circ\text{C}$ . LTC1326 Only  $V_{CC3} = 3.3\text{V}$ ,  $V_{CC5} = 5\text{V}$ ,  $V_{CCA} = V_{CC3}$ ,  $T_A = 25^\circ\text{C}$  unless otherwise noted.

SYMBOL	PARAMETER	CONDITIONS	MIN	TYP	MAX	UNITS
$V_{OH}$	$\overline{\text{RST}}$ Output Voltage High (Note 3)	$I_{SOURCE} = 1\mu\text{A}$	● $V_{CC3} - 1$			V
	$\overline{\text{SRST}}$ Output Voltage High (Note 3)	$I_{SOURCE} = 1\mu\text{A}$	● $V_{CC3} - 1$			V
	$\overline{\text{RST}}$ Output Voltage High	$I_{SOURCE} = 600\mu\text{A}$	● $V_{CC3} - 1$			V
$t_{PHL}$	Prop Delay $\overline{\text{RST}}$ to RST High Input to Low Output	$C_{RST} = 20\text{pF}$		25		ns
$t_{PLH}$	Prop Delay $\overline{\text{RST}}$ to RST Low Input to High Output	$C_{RST} = 20\text{pF}$		45		ns
$V_{OVR}$	$V_{CC5}$ Reset Override Voltage	Override $V_{CC5}$ Ability to Assert $\overline{\text{RST}}$ (Note 4)		$V_{CC3} \pm 0.025$		V

**Note 1:** Stresses beyond those listed under Absolute Maximum Ratings may cause permanent damage to the device. Exposure to any Absolute Maximum Rating condition for extended periods may affect device reliability and lifetime.

**Note 2:** All voltage values are with respect to GND.

**Note 3:** The output pins  $\overline{\text{SRST}}$  and  $\overline{\text{RST}}$  have weak internal pull-ups to  $V_{CC3}$  of  $6\mu\text{A}$  typ. However, external pull-up resistors may be used when faster rise times are required.

**Note 4:** The  $V_{CC5}$  reset override voltage is valid for an operating range less than approximately 4.15V. Above this point the override is turned off and the  $V_{CC5}$  pin functions normally.

## TYPICAL PERFORMANCE CHARACTERISTICS

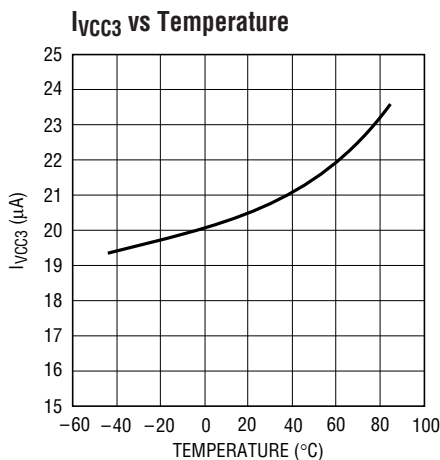

1326/2.5 G01

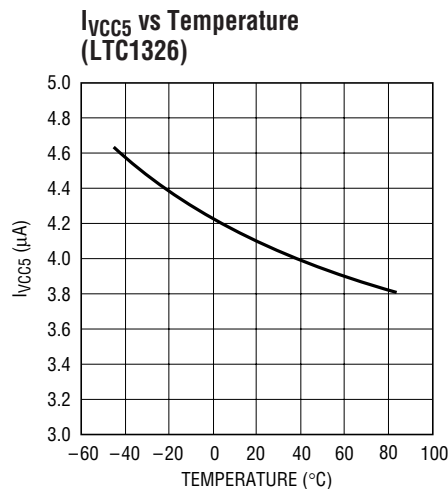

1326/2.5 G02

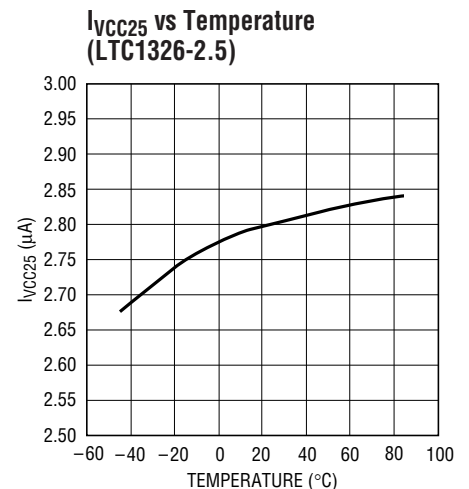

1326/2.5 G03

# TYPICAL PERFORMANCE CHARACTERISTICS

**V<sub>CCA</sub> Input Current vs Input Voltage**

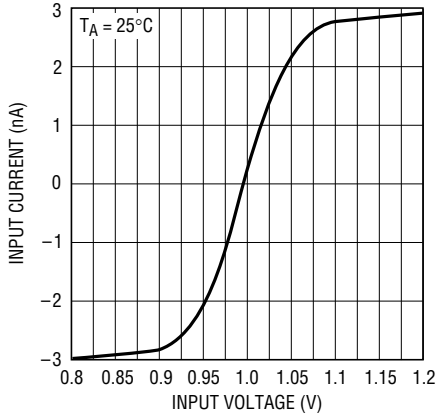

1326/2.5 G04

**V<sub>CC5</sub> Transient Immunity (LTC1326)**

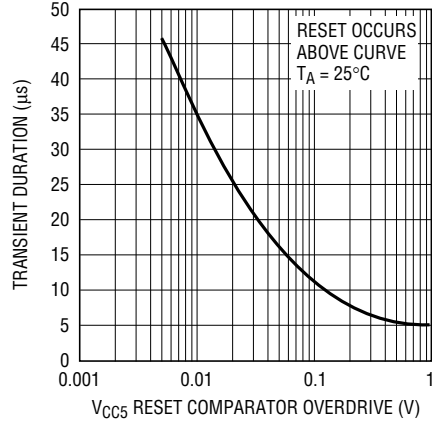

1326/2.5 G05

**V<sub>CC25</sub> Transient Immunity (LTC1326-2.5)**

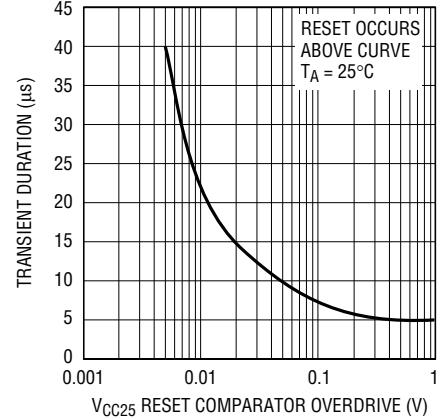

1326/2.5 G06

**V<sub>CCA</sub> Transient Immunity**

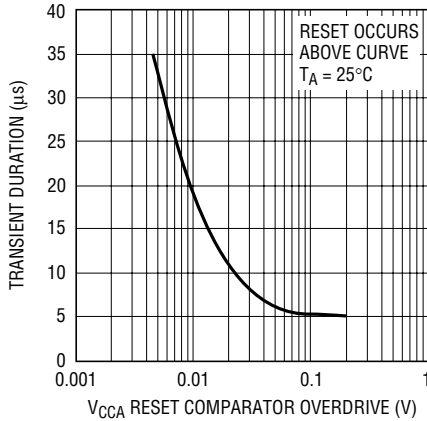

1326/2.5 G07

**V<sub>CC3</sub> Transient Immunity**

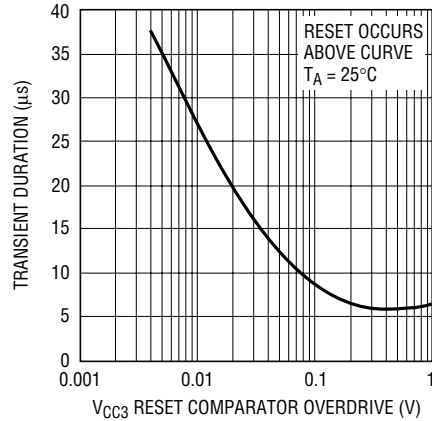

1326/2.5 G08

**V<sub>CC5</sub> Threshold Voltage vs Temperature (LTC1326)**

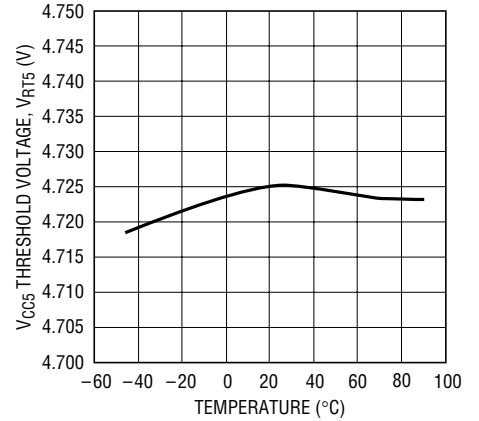

1326/2.5 G09

**V<sub>CC25</sub> Threshold Voltage vs Temperature (LTC1326-2.5)**

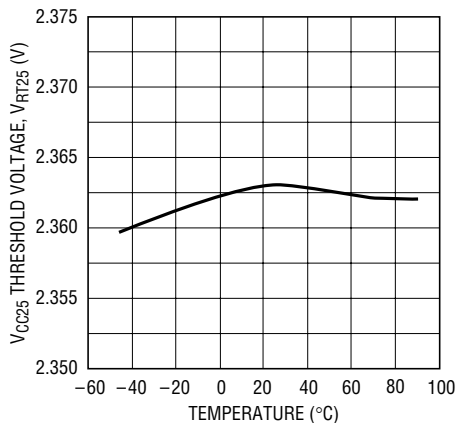

1326/2.5 G10

**V<sub>CC3</sub> Threshold Voltage vs Temperature**

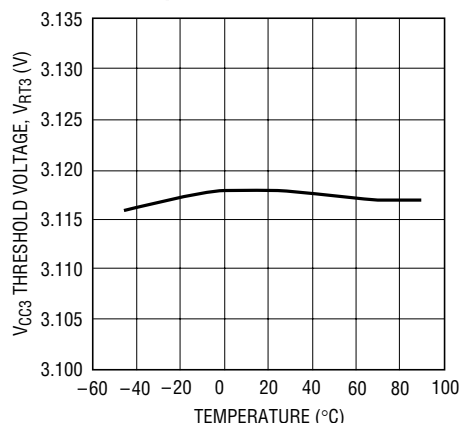

1326/2.5 G11

**V<sub>CCA</sub> Threshold Voltage vs Temperature**

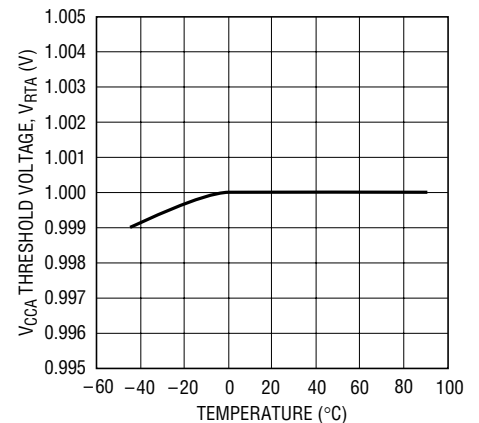

1326/2.5 G12

## TYPICAL PERFORMANCE CHARACTERISTICS

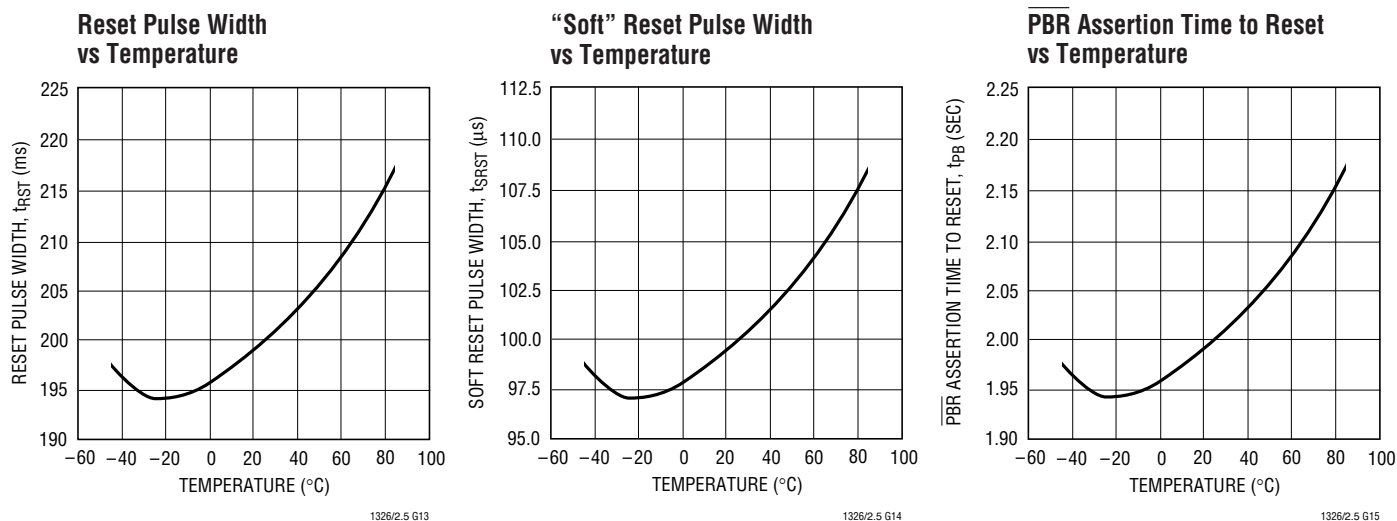

## PIN FUNCTIONS

**V<sub>CC3</sub> (Pin 1):** 3.3V Sense Input and Power Supply Pin for the IC. Bypass to ground with  $\geq 0.1\mu\text{F}$  ceramic capacitor.

**V<sub>CC5</sub> (Pin 2) (LTC1326):** 5V Sense Input. Used as gate drive for the  $\overline{\text{RST}}$  output FET when the voltage on V<sub>CC3</sub> is less than the voltage on V<sub>CC5</sub>. If unused, it can be tied to V<sub>CC3</sub> (see Dual and Single Supply Monitor Operation in the Applications Information section).

**V<sub>CC25</sub> (Pin 2) (LTC1326-2.5):** 2.5V Sense Input. Used as gate drive for RST output FET when the voltage on V<sub>CC3</sub> is less than the voltage on V<sub>CC25</sub>. If unused, it can be tied to V<sub>CC3</sub>.

**V<sub>CCA</sub> (Pin 3):** 1V Sense, High Impedance Input. Can be used as a logic input with a 1V threshold. If unused, it can be tied to either V<sub>CC3</sub> or V<sub>CC25</sub>.

**GND (Pin 4):** Ground.

**RST (Pin 5):** Reset Logic Output. Active high CMOS logic output, drives high to V<sub>CC3</sub>, buffered complement of  $\overline{\text{RST}}$ . An external pull-down on the RST pin will drive this pin high.

**$\overline{\text{RST}}$  (Pin 6):** Reset Logic Output. Active low, open-drain logic output with weak pull-up to V<sub>CC3</sub>. Can be pulled up greater than V<sub>CC3</sub> when interfacing to 5V logic. Asserted when one or more of the supplies are below trip thresholds and held for 200ms after all supplies become valid. Also asserted after PBR is held low for more than 2 seconds and for an additional 200ms after PBR is released.

**SRST (Pin 7):** Soft Reset. Active low, open-drain logic output with weak pull-up to V<sub>CC3</sub>. Can be pulled up greater than V<sub>CC3</sub> when interfacing to 5V logic. Asserted for 100 $\mu\text{s}$  after PBR is held low for less than 2 seconds and released.

**PBR (Pin 8):** Push-Button Reset. Active low logic input with weak pull-up to V<sub>CC3</sub>. Can be pulled up greater than V<sub>CC3</sub> when interfacing to 5V logic. When asserted for less than 2 seconds, outputs a soft reset 100 $\mu\text{s}$  pulse on the SRST pin. When PBR is asserted for greater than 2 seconds, the  $\overline{\text{RST}}$  output is forced low and remains low until 200ms after PBR is released.

**BLOCK DIAGRAMS**

LTC1326

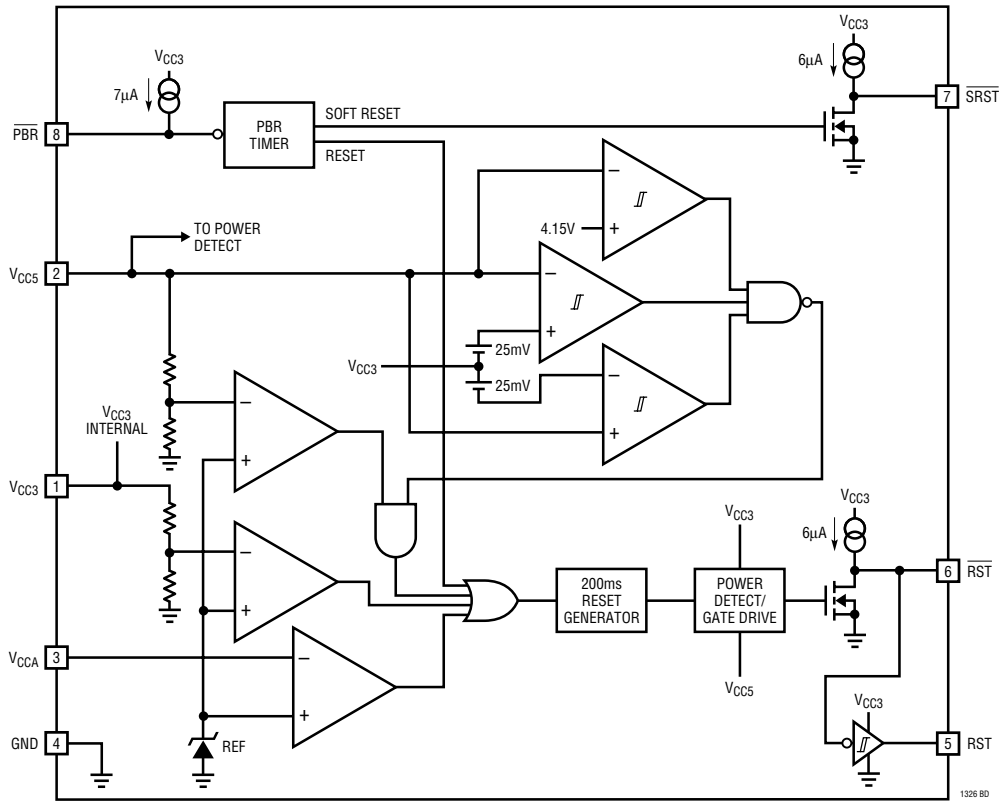

LTC1326-2.5

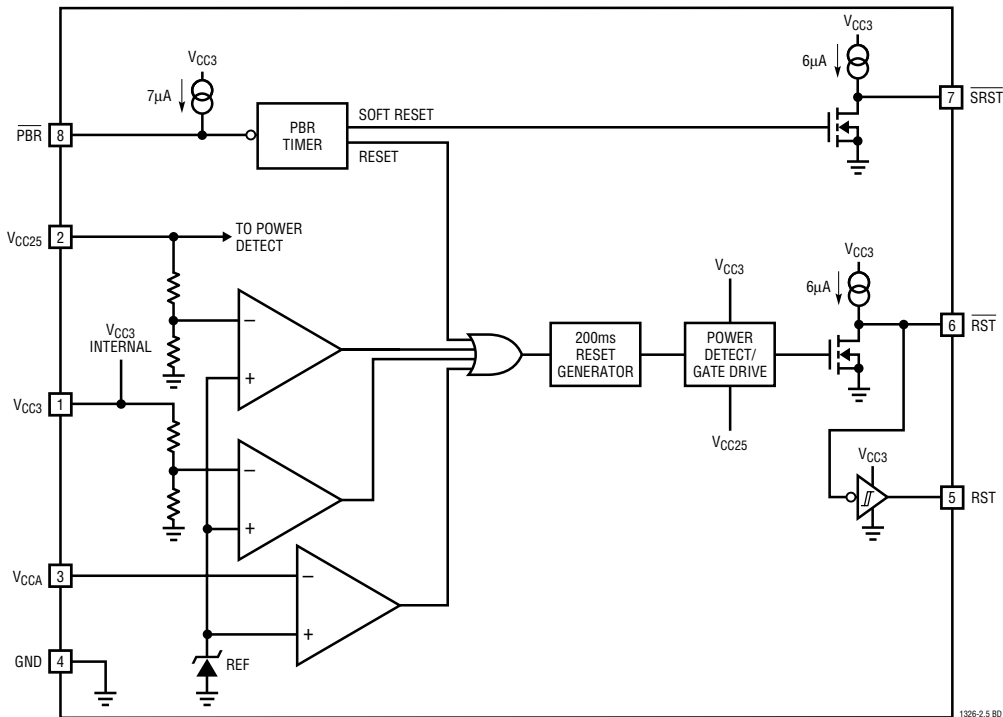

## TIMING DIAGRAMS

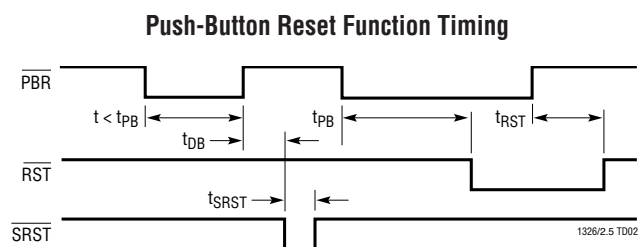
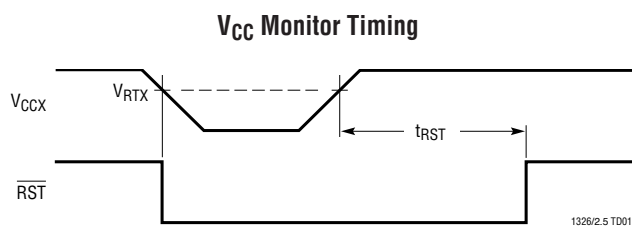

## APPLICATIONS INFORMATION

## Operation

The LTC1326/LTC1326-2.5 are micropower, high accuracy triple supply monitoring circuits. The parts have two basic functions: generation of a reset when power supplies are out of range, and generation of reset or a “soft” reset when the  $\overline{\text{PBR}}$  pin is pulled low.

## Supply Monitoring

All three  $V_{\text{CC}}$  inputs must be above predetermined thresholds for 200ms before the reset output is released. The parts will assert reset during power-up, power-down and brownout conditions on any one or more of the  $V_{\text{CC}}$  inputs.

On power-up, either the  $V_{\text{CC5}}$  or  $V_{\text{CC3}}$  pin on the LTC1326, or the  $V_{\text{CC25}}$  or  $V_{\text{CC3}}$  pin on the LTC1326-2.5, can power the drive circuits for the  $\overline{\text{RST}}$  pin. This ensures that  $\overline{\text{RST}}$  will be low when  $V_{\text{CC5}}$ ,  $V_{\text{CC25}}$  or  $V_{\text{CC3}}$  reaches 1V. As long as any one of the  $V_{\text{CC}}$  inputs is below its predetermined threshold,  $\overline{\text{RST}}$  will stay a logic low. Once all of the  $V_{\text{CC}}$  inputs rise above their thresholds, an internal timer is started and  $\overline{\text{RST}}$  is released after 200ms. The  $\overline{\text{RST}}$  pin outputs the inverted state of what is seen on  $\overline{\text{RST}}$  pin.

$\overline{\text{RST}}$  is reasserted whenever any one of the  $V_{\text{CC}}$  inputs drops below its predetermined threshold and remains asserted until 200ms after all of the  $V_{\text{CC}}$  inputs are above their thresholds.

On power-down, once any of the  $V_{\text{CC}}$  inputs drop below its threshold,  $\overline{\text{RST}}$  is held at a logic low. A logic low of 0.4V is guaranteed until  $V_{\text{CC3}}$  and  $V_{\text{CC5}}$  on the LTC1326 or  $V_{\text{CC3}}$  and  $V_{\text{CC25}}$  on the LTC1326-2.5 drop below 1V.

The three internal precision voltage comparators have response times that are typically 13 $\mu\text{s}$ . This slow response time helps prevent mistripping due to transients on each of the  $V_{\text{CC}}$  inputs. The part's ability to suppress transients can be improved by bypassing each of the  $V_{\text{CC}}$  inputs with a 0.1 $\mu\text{F}$  capacitor to ground.

## Push-Button Reset

The parts provide a push-button reset input pin. The  $\overline{\text{PBR}}$  input has an internal pull-up current source to  $V_{\text{CC3}}$ . If the  $\overline{\text{PBR}}$  pin is not used it can be left floating.

When the  $\overline{\text{PBR}}$  is pulled low for less than  $t_{\text{PB}}$  ( $\approx 2$  sec), a narrow (100 $\mu\text{s}$  typ) soft reset pulse is generated on the  $\overline{\text{SRST}}$  output pin after the button is released. The push-button circuitry contains an internal debounce counter which delays the output of the soft reset pulse by typically 20ms. This pin can be OR-tied to the  $\overline{\text{RST}}$  pin and issue what is called a “soft” reset. The  $\overline{\text{SRST}}$  thereby resets the microprocessor without interrupting the DRAM refresh cycle. In this manner DRAM information remains undisturbed. Alternatively,  $\overline{\text{SRST}}$  may be monitored by the processor to initiate a software-controlled reset.

When the  $\overline{\text{PBR}}$  pin is held low for longer than  $t_{\text{PB}}$  ( $\approx 2$  sec), a standard reset is generated on the  $\overline{\text{RST}}$  and  $\overline{\text{RST}}$  pins. Once the 2 second period has elapsed, a reset signal is produced by the push-button logic, thereby clearing the reset counter. Once the button is released, the reset counter begins counting the reset period (200ms nominal). Consequently, the reset outputs remain asserted for approximately 200ms after the button is released.



## APPLICATIONS INFORMATION

During a supply induced reset condition, the ability of the PBR pin to force a soft reset condition on the SRST pin is disabled. In other words SRST will remain high. If the PBR pin is held low, both during and after a supply induced reset (low RST), the RST pin will remain low until 200ms after the PBR goes high.

### Power Detect/Gate Drive

The LTC1326/LTC1326-2.5 for the most part are powered internally from the V<sub>CC3</sub> pin. The exception is at the gate drive of the output FET on the RST pin. On the input to this FET is power detection circuitry used to detect and drive the gate from either the 3.3V input pin (V<sub>CC3</sub>) or the 5V input pin (V<sub>CC5</sub>) on the LTC1326 or the 2.5V input pin (V<sub>CC25</sub>) on the LTC1326-2.5. The gate drive is derived from the pin with the highest potential. This ensures the part pulls the RST pin low as soon as either input pin is ≥ 1V.

### Dual and Single Supply Monitor Operation

The V<sub>CC3</sub>, V<sub>CC5</sub> and V<sub>CCA</sub> inputs may be individually disabled by the following override techniques which allow the LTC1326 or LTC1326-2.5 to be used as a dual or single supply monitor.

### LTC1326 Override Functions

The V<sub>CCA</sub> pin, if unused, can be tied to either V<sub>CC3</sub> or V<sub>CC5</sub>. This is an obvious solution since the trip points for V<sub>CC3</sub> and V<sub>CC5</sub> will always be greater than the trip point for V<sub>CCA</sub>.

The V<sub>CC5</sub> input trip point is disabled if its voltage is equal to the voltage on V<sub>CC3</sub> ±25mV and the voltage on V<sub>CC5</sub> is less than 4.15V. In this manner, the part will behave as a 3.3V monitor and the V<sub>CC5</sub> reset will be disabled.

The V<sub>CC5</sub> trip point is reenabled when the voltage on V<sub>CC5</sub> is equal to the voltage on V<sub>CC3</sub> ±25mV and the two inputs are greater than approximately 4.15V. In this manner, the LTC1326 can function as a 5V monitor with the 3.3V monitor disabled.

When monitoring either 3.3V or 5V with V<sub>CC3</sub> strapped to V<sub>CC5</sub> (see Figure 1), the LTC1326 determines which is the

appropriate range. The LTC1326 handles this situation as shown in Figure 2. Above 1V and below V<sub>RT3</sub>, RST is held low. From V<sub>RT3</sub> to approximately 4.15V, the LTC1326 assumes 3.3V supply monitoring and RST is deasserted. Above approximately 4.15V, the LTC1326 operates as a 5V monitor. In most systems, the 5V supply will pass through the 3.1V to 4.15V region in <200ms during power-up, and the RST output will behave as desired. Table 1 summarizes the state of RST and RST at various operating voltages with V<sub>CC3</sub> = V<sub>CC5</sub>.

Table 1. Override Truth Table (V<sub>CC3</sub> = V<sub>CC5</sub>)

INPUTS (V <sub>CC3</sub> = V <sub>CC5</sub> = V <sub>CC</sub> )	RST	RST
0V ≤ V <sub>CC</sub> ≤ 1V	—	—
1V ≤ V <sub>CC</sub> ≤ V <sub>RT3</sub>	0	1
V <sub>RT3</sub> ≤ V <sub>CC</sub> ≤ 4.15V	1	0
4.15V ≤ V <sub>CC</sub> ≤ V <sub>RT5</sub>	0	1
V <sub>RT5</sub> ≤ V <sub>CC</sub>	1	0

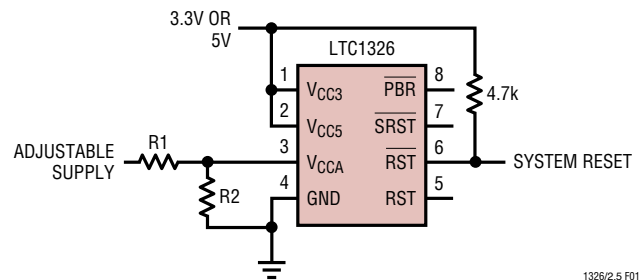

Figure 1

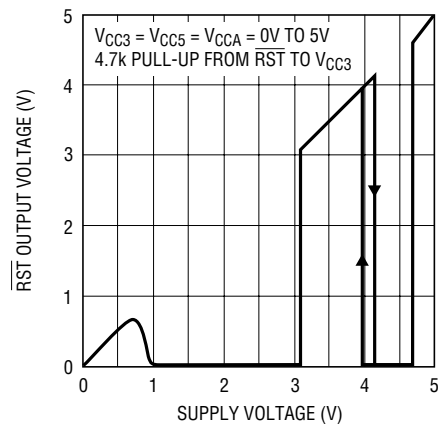
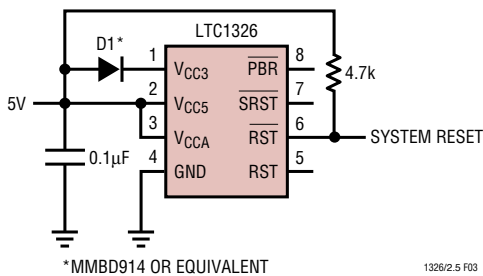

Figure 2. RST Voltage vs Supply Voltage

## APPLICATIONS INFORMATION

Figure 3 contains a simple circuit for 5V systems that can't risk the  $\overline{\text{RST}}$  output going high in the 3.1V to 4.15V range (possibly due to very slow rise time on the 5V supply). Diode D1 powers the LTC1326 while dropping  $\approx 0.6\text{V}$  from the  $V_{\text{CC5}}$  pin to the  $V_{\text{CC3}}$  pin. This prevents the part's internal override circuit from being activated. Without the override circuit active, the  $\overline{\text{RST}}$  pin stays low until  $V_{\text{CC5}}$  reaches  $V_{\text{RT5}} \cong 4.725\text{V}$  (See Figure 4).



**Figure 3. LTC1326 Monitoring a Single 5V Supply. D1 Used to Avoid  $\overline{\text{RST}}$  High Near 3.3V to 4V (See Figure 2).**

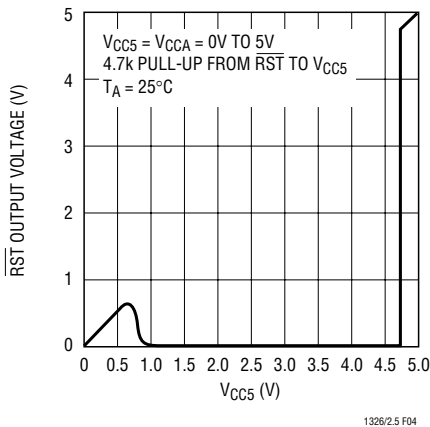

**Figure 4.  $\overline{\text{RST}}$  Output Voltage Characteristics of the Circuit in Figure 3**

### LTC1326-2.5 Override Functions

The  $V_{\text{CCA}}$  pin, if unused, can be tied to either  $V_{\text{CC3}}$  or  $V_{\text{CC25}}$ . This is an obvious solution since the trip points for  $V_{\text{CC3}}$  and  $V_{\text{CC25}}$  will always be greater than the trip point for  $V_{\text{CCA}}$ . Likewise, the  $V_{\text{CC25}}$ , if unused, can be tied to  $V_{\text{CC3}}$ .  $V_{\text{CC3}}$  must always be used. Tying  $V_{\text{CC3}}$  to  $V_{\text{CC25}}$  and operating off of a 2.5V supply will result in the continuous assertion of  $\overline{\text{RST}}$ .

### Extending ESD Tolerance on the $\overline{\text{PBR}}$ Input Pin

The  $\overline{\text{PBR}}$  pin is susceptible to ESD since it may be brought out to a front panel in normal applications. The ESD tolerance of this pin can be increased by adding a resistor in series with the  $\overline{\text{PBR}}$  pin. A 10k resistor can increase the ESD tolerance of the  $\overline{\text{PBR}}$  pin to approximately 10kV. The  $\overline{\text{PBR}}$ 's internal pull-up current of  $7\mu\text{A}$  typical means there is only 70mV (150mV max) dropped across the resistor. See Figure 5.

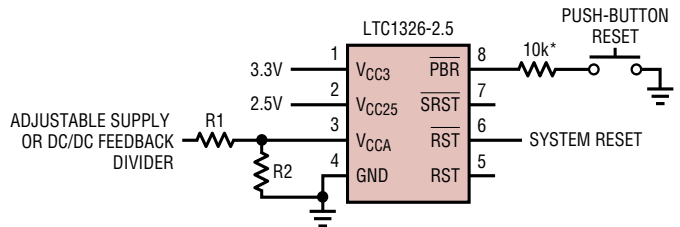

\*OPTIONAL RESISTOR EXTENDS ESD TOLERANCE OF  $\overline{\text{PBR}}$  INPUT TO APPROXIMATELY 10kV  
1326/2.5 F05

**Figure 5. Triple Supply Monitor (3.3V, 2.5V and Adjustable) with Extended ESD Tolerance**

# TYPICAL APPLICATIONS

## Triple Supply Monitor (3.3V, 5V and Adjustable)

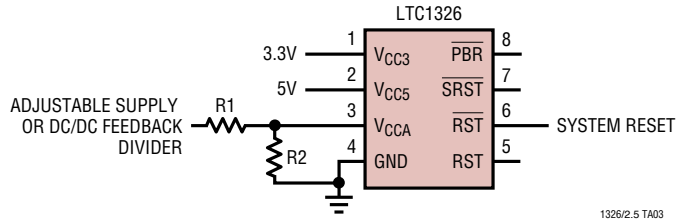

## Dual Supply Monitor (3.3V and 5V, Defeat VCCA Input)

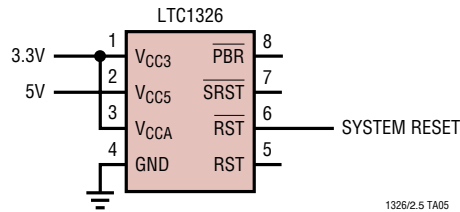

## Dual Supply Monitor (3.3V or 5V Plus Adj)

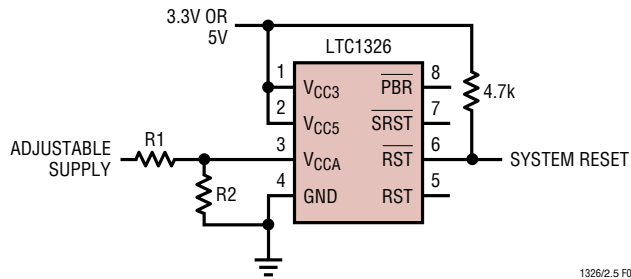

REFER TO LTC1326 OVERRIDE FUNCTIONS IN THE APPLICATIONS INFORMATION SECTION.

## Dual Supply Monitor (3.3V Plus Adj)

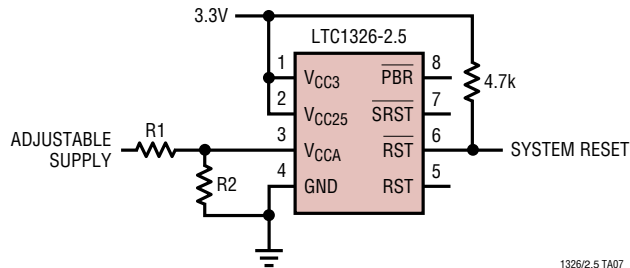



# TYPICAL APPLICATIONS

## Monitoring a Negative Supply

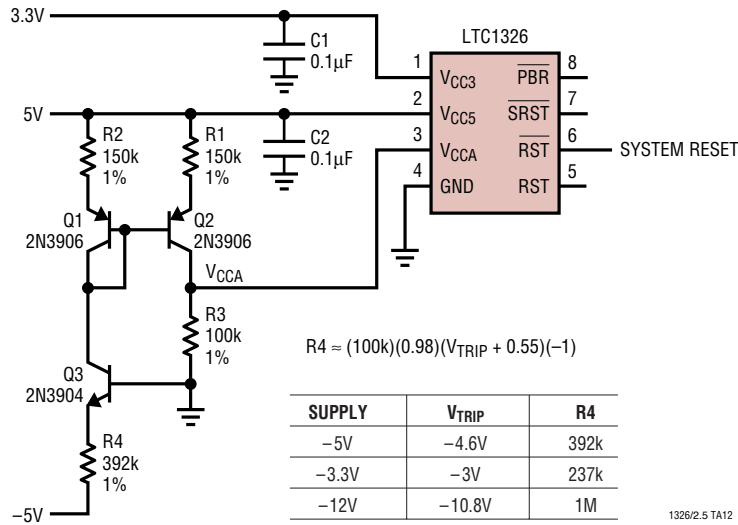

## Reset Valid for $V_{CC3}$ Down to 0V

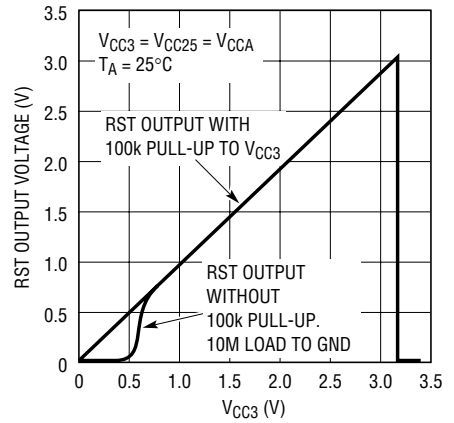
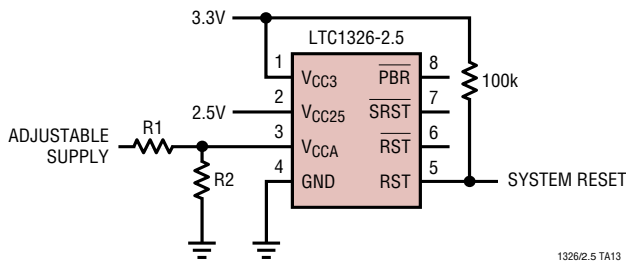

**PACKAGE DESCRIPTION**

**MS8 Package**  
**8-Lead Plastic MSOP**  
 (Reference LTC DWG # 05-08-1660)

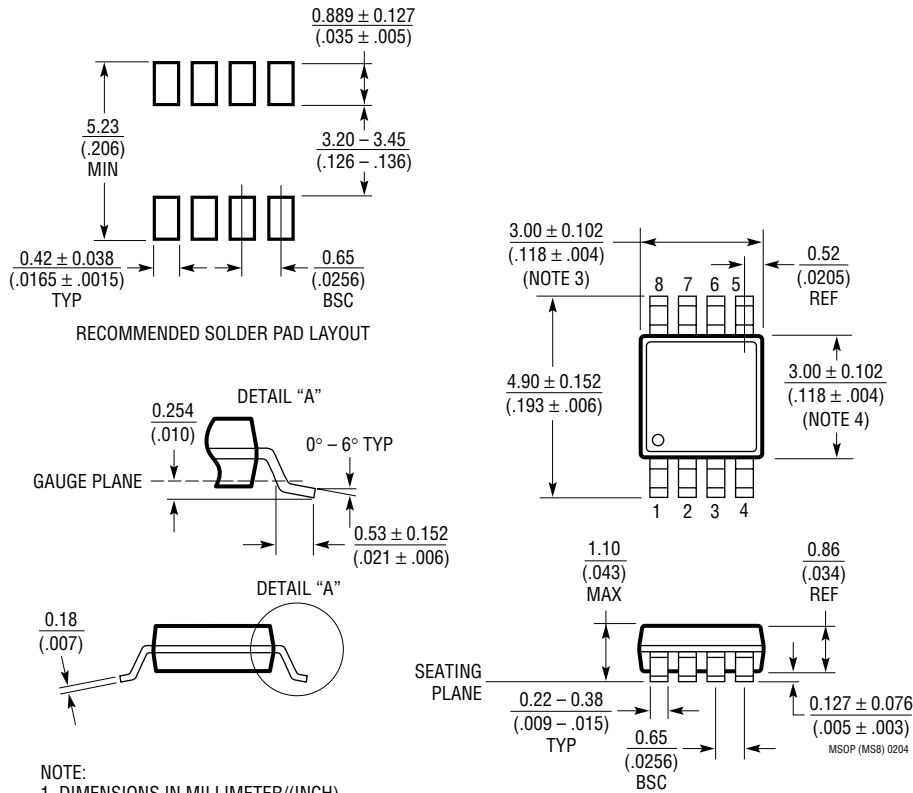

- NOTE:
1. DIMENSIONS IN MILLIMETER/(INCH)
  2. DRAWING NOT TO SCALE
  3. DIMENSION DOES NOT INCLUDE MOLD FLASH, PROTRUSIONS OR GATE BURRS.  
MOLD FLASH, PROTRUSIONS OR GATE BURRS SHALL NOT EXCEED 0.152mm (.006") PER SIDE
  4. DIMENSION DOES NOT INCLUDE INTERLEAD FLASH OR PROTRUSIONS.  
INTERLEAD FLASH OR PROTRUSIONS SHALL NOT EXCEED 0.152mm (.006") PER SIDE
  5. LEAD COPLANARITY (BOTTOM OF LEADS AFTER FORMING) SHALL BE 0.102mm (.004") MAX

# PACKAGE DESCRIPTION

## S8 Package 8-Lead Plastic Small Outline (Narrow .150 Inch) (Reference LTC DWG # 05-08-1610)

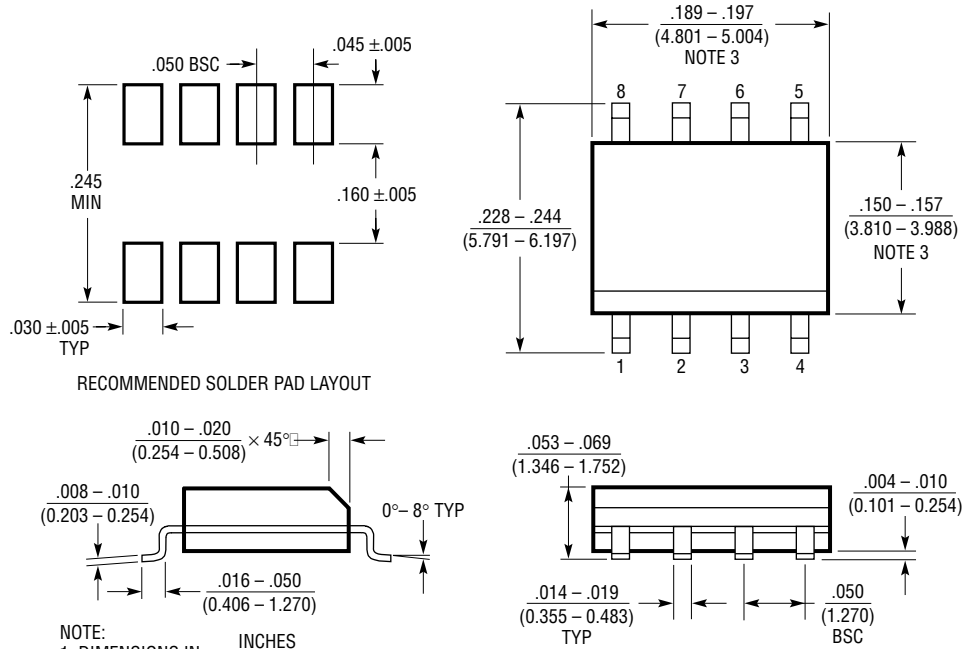

- NOTE:  
 1. DIMENSIONS IN INCHES (MILLIMETERS)  
 2. DRAWING NOT TO SCALE  
 3. THESE DIMENSIONS DO NOT INCLUDE MOLD FLASH OR PROTRUSIONS. MOLD FLASH OR PROTRUSIONS SHALL NOT EXCEED .006" (0.15mm)

S08 0303

## TYPICAL APPLICATION

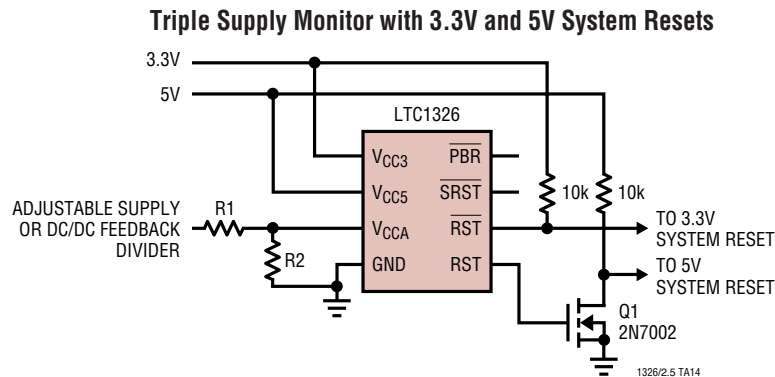

## RELATED PARTS

PART NUMBER	DESCRIPTION	COMMENTS
LTC690	5V Supply Monitor, Watchdog Timer and Battery Backup	4.65V Threshold
LTC694-3.3	3.3V Supply Monitor, Watchdog Timer and Battery Backup	2.9V Threshold
LTC699	5V Supply Monitor and Watchdog Timer	4.65V Threshold
LTC1232	5V Supply Monitor, Watchdog Timer and Push-Button Reset	4.37V/4.62V Threshold
LTC1443/LTC1444/ LTC1445	Micropower Quad Comparators with 1% Reference	LTC1443 has 1.182V Reference, LTC1444/LTC1445 have 1.221V Reference and Adjustable Hysteresis
LTC1536	Precision Triple Supply Monitor for PCI Applications	Meets PCI $t_{FAIL}$ Timing Specifications
LTC1540	Nanopower Comparator with 2% Reference	1.182V Reference, 300nA Supply Current, 8-Pin MSOP
LTC1726-2.5	Micropower Triple Supply Monitor for 2.5V, 3.3V and ADJ	Adjustable $\overline{RESET}$ and Watchdog Time Outs
LTC1726-5	Micropower Triple Supply Monitor for 5V, 3.3V and ADJ	Adjustable $\overline{RESET}$ and Watchdog Time Outs
LTC1727-2.5	Micropower Triple Supply Monitor with Individual Outputs	2.338V, 3.086V, 1V Thresholds ( $\pm 1.5\%$ ) 2.5, 3.3V, ADJ
LTC1727-5	Micropower Triple Supply Monitor with Individual Outputs	4.675V, 3.086V, 1V Thresholds ( $\pm 1.5\%$ ) 5V, 3.3V, ADJ
LTC1728-1.8	Micropower Triple Supply Monitor in 5-Pin SOT-23 Package	2.805V, 1.683V, 1V Thresholds ( $\pm 1.5\%$ ) 3V, 1.8V, ADJ
LTC1728-2.5	Micropower Triple Supply Monitor in 5-Pin SOT-23 Package	2.338V, 3.086V, 1V Thresholds ( $\pm 1.5\%$ ) 2.5, 3.3V, ADJ
LTC1728-5	Micropower Triple Supply Monitor in 5-Pin SOT-23 Package	4.675V, 3.086V, 1V Thresholds ( $\pm 1.5\%$ ) 5V, 3.3V, ADJ
LTC1985-1.8	Micropower Triple Supply Monitor for 3V, 1.8V and ADJ	Push-Pull $\overline{RESET}$ Output, SOT-23
LTC2900	Programmable Quad Supply Monitor	Adjustable Reset, 10-Lead MSOP and 3mm $\times$ 3mm 10-Lead DFN Package
LTC2901	Programmable Quad Supply Monitor	Adjustable Reset and Watchdog Timer, 16-Lead SSOP Package
LTC2902	Programmable Quad Supply Monitor	Adjustable Reset and Tolerance, 16-Lead SSOP Package, Margining Functions
LTC2903	Precision Quad Supply Monitor	6-Lead SOT-23 Package, Ultralow Voltage Reset
LTC2904/LTC3905	3-State Programmable Precision Dual Supply Monitor	Adjustable Tolerance and Reset Timer, 8-Lead SOT-23 Package
LTC2906/LTC2907	Precision Dual Supply Monitor 1-Selectable and 1 Adjustable	Separate $V_{CC}$ Pin, RST/ $\overline{RST}$ Outputs/Adjustable Reset Timer
LTC2908	Precision Six Supply Monitor (4 Fixed and 2 Adjustable)	8-Lead SOT-23 and DDB Packages