



Compact size and well known for its proven reliability, the A-Series utilizes the hydraulic magnetic principle which provides precise operation and performance even when exposed to extremely hot and/or cold application environments. When aesthetics demand a clean contemporary and functional design, the visi-rocker two-color actuator can be specified. A rockerguard and push-to-reset bezel help prevent inadvertent actuation. A specially constructed version is now available for applications requiring CE markings. The A-Series is used in many telecommunications and marine applications. In addition, these breakers meet CSA Standard 22.2 No. 100 for the Generator & Welder markets.

1-6 poles (handle), 1-3 poles (rocker). 0.02 - 50 amps, up to 277 VAC or 80 VDC, with a choice of time delays, terminals and actuator colors.

Agency Certifications

UL Recognized

UL Standard 1077



Component Recognition Program as Protectors Supplementary (Guide CCN/QVNU2, File E75596)

UL Standard 508



Switches, Industrial Control (Guide CCN/NRNT2, File E148683)

UL Standard 1500



Protectors, Supplementary for Marine Electrical & Fuel Systems (Guide PEQZ2, File E75596) Ignition Protection

UL Listed

UL Standard 489A



Communications Equipment (Guide CCN/DITT, File E189195)

CSA Accepted



Component Supplementary Protector under Class 3215 30, File 047848 0 000 CSA Standard C22.2 No. 235

TUV Certified



EN60934, under License No. R72040875

VDE Certified



EN60934, VDE 0642 under File No. 10537

Electrical

Table A: Lists UL Recognized & CSA Accepted configurations and performance capabilities as a Component Supplementary Protector.

A-SERIES TABLE A: COMPONENT SUPPLEMENTARY PROTECTORS										
CIRCUIT CONFIGURATION	VOLTAGE			CURRENT RATING		SHORT CIRCUIT CAPACITY (AMPS)		APPLICATION CODES		CONSTRUCTION NOTES
	MAX. RATING	FREQUENCY	PHASE	FULL LOAD AMPS	GENERAL PURPOSE AMPS	UL/CSA		UL	CSA	
						WITH BACKUP FUSE	WITHOUT BACKUP FUSE			
SERIES	32	DC	--	0.02 - 50	---	--	5000	TC1, OL1,U2	TC1, OL1,U2	
	65	DC	--	31 - 50	---	--	7500	TC1,2, OL1,U1	TC1,2, OL1,U1	
	80	DC	--	0.02 - 30	---	--	7500	TC1,2, OL1,U1	TC1,2, OL1,U1	
				---	31 - 50	--	7500	TC1,2, OL0,U1	TC1,2, OL0,U1	
	125	50 / 60	1	0.02 - 30	---	--	3000	TC1, OL1,U2	TC1, OL1,U2	Rocker Version
	125	50 / 60	1	1 - 50	---	--	2000	TC1, OL1,U2	TC1, OL1,U2	
	125	50 / 60	1 ⁴	1 - 50	---	--	1000	TC1, OL1,U2	TC3, OL1,U3	
	125 / 250	50 / 60	1 ³	0.02 - 30	---	--	3000	TC1,2, OL1,U2	TC1,2, OL1,U2	Rocker Version
	125 / 250	50 / 60	1 ³	0.02 - 50	---	--	3000	TC1,2, OL1,U2	TC1,2, OL1,U2	
	250	50 / 60	1	0.02 - 30	---	--	1500	TC1, OL0,U2	TC1, OL0,U2	Single Pole Break
				0.02 - 30	---	--	3000	TC1, OL1,U2	TC1, OL1,U2	Two Pole Break
				---	31 - 50	--	3000	TC1,2, OL0,U1	TC1,2, OL1,U1	
			1 ⁴	1 - 50	---	1000	TC1, OL1,U2	TC3, OL1,U3		
			3	0.02 - 30	---	5000 ²	---	TC1,2, OL1,C1	TC1,2, OL1,C1	
			31 - 50	---	2000 ¹	---	TC1,2, OL1,C1	TC1,2, OL1,C1		
277	50 / 60	1	0.02 - 30	---	5000 ¹	---	TC1,2, OL1,C1	TC1,2, OL1,C1		
DUAL COIL	32	DC	--	0.02 - 50	---	--	5000	TC1, OL1,U2	TC1, OL1,U2	
	65	DC	--	0.02 - 50	---	--	7500	TC1,2, OL1,U1	TC1,2, OL1,U1	
	80	DC	--	0.02 - 30	---	--	7500	TC1,2, OL1,U1	TC1,2, OL1,U1	
				---	31 - 50	--	7500	TC1,2, OL0,U1	TC1,2, OL0,U1	
	125	50 / 60	1	0.02 - 30	---	--	3000	TC1, OL1,U2	TC1, OL1,U2	Rocker Version
				1 - 50	---	--	2000	TC1, OL1,U2	TC1, OL1,U2	
	125	50 / 60	1 ⁴	1 - 50	---	--	1000	TC1, OL1,U2	TC3, OL1,U3	
	125 / 250	50 / 60	1 ³	0.02 - 30	---	--	3000	TC1,2, OL1,U1	TC1,2, OL1,U1	Rocker Version
	125 / 250	50 / 60	1 ³	0.02 - 50	---	--	3000	TC1,2, OL1,U2	TC1,2, OL1,U2	
	250	50 / 60	1	0.02 - 30	---	--	1500	TC1, OL0,U2	TC1, OL0,U2	Single Pole Break
				0.02 - 30	---	--	3000	TC1, OL1,U2	TC1, OL1,U2	Two Pole Break
				---	31 - 50	--	3000	TC1,2, OL0,U1	TC1,2, OL0,U1	
			1 ⁴	1 - 50	---	1000	TC1, OL1,U2	TC3, OL1,U3		
			3	0.02 - 30	---	5000 ²	---	TC1,2, OL1,C1	TC1,2, OL1,C1	
			31 - 50	---	2000 ¹	---	TC1,2, OL1,C1	TC1,2, OL1,C1		
277	50 / 60	1	0.02 - 30	---	5000 ¹	---	TC1,2, OL1,U1	TC1,2, OL1,U1		
SHUNT	80	DC	--	0.02 - 30	---	--	7500	TC1,2, OL1,U1	TC1,2, OL1,U1	
	125 / 250	50 / 60	1	0.02 - 30	---	--	3000	TC1,2, OL1,U1	TC1,2, OL1,U1	
	250	50 / 60	1	0.02 - 30	---	--	3000	TC1,2, OL1,U1	TC1,2, OL1,U1	
			3	0.02 - 30	---	5000 ²	---	TC1,2, OL1,C1	TC1,2, OL1,C1	
	277	50 / 60	1	0.02 - 30	---	5000 ¹	---	TC1,2, OL1,C1	TC1,2, OL1,C1	
RELAY	80	DC	--	0.02 - 30	---	--	7500	TC1,2, OL1,U1	TC1,2, OL1,U1	
	125 / 250	50 / 60	1 ³	0.02 - 30	---	--	3000	TC1,2, OL1,U1	TC1,2, OL1,U1	
	250	50 / 60	1	0.02 - 30	---	--	3000	TC1,2, OL1,U1	TC1,2, OL1,U1	
			3	0.02 - 30	---	5000 ²	---	TC1,2, OL1,C1	TC1,2, OL1,C1	
277	50 / 60	1	0.02 - 30	---	5000 ¹	---	TC1,2, OL1,C1	TC1,2, OL1,C1		
SWITCH ONLY	65	DC	--	0.02 - 50	---					
	80	DC	--	0.02 - 30	---					
	250	50 / 60	1	---	31 - 50					
			3	0.02 - 50	---					
277	50 / 60	1	0.02 - 30	31 - 50						

Notes for Table A:

- 1 Requires branch circuit backup with a UL LISTED Type K5 or RK5 fuse (15A minimum) at no more than 4 times the rating of the protector.
- 2 Same as note 1, except that backup fuse is limited to 80 A maximum.
- 3 2 pole protector required (with one pole per power line) for: 250/125 VAC, 125/250 VAC and 208Y/120 VAC Power Systems. 1 pole protector required for : 125 VAC, 1Ø Power System.
- 4 Meets the requirements of CSA 22.2 No. 100-04 - Motors and Generators.

Electrical

Table B: Lists UL Recognized, CSA Accepted, VDE & TUV Certified configurations & performance capabilities as a Component Supplementary Protector.

A-SERIES TABLE B: COMPONENT SUPPLEMENTARY PROTECTORS														
CIRCUIT CONFIGURATION	VOLTAGE			CURRENT RATING		SHORT CIRCUIT CAPACITY (AMPS)					APPLICATION CODES		VDE CONSTRUCTION NOTES	
	MAX. RATING	FREQUENCY	PHASE	FULL LOAD AMPS	GENERAL PURPOSE AMPS	UL/CSA		VDE		TUV		UL		CSA
						WITH BACKUP FUSE	WITHOUT BACKUP FUSE	(Inc) WITH BACKUP FUSE	(Inc) WITHOUT BACKUP FUSE	(Inc) WITH BACKUP FUSE	(Inc) WITHOUT BACKUP FUSE			
SERIES	65	DC	---	0.10 - 50	---	---	7500	---	---	5000	3000	TC1,2, OL1,U1	TC1,2, OL1,U1	World Market Breaker TUV Only
	80	DC	---	0.10 - 30	---	---	7500	3000	1500	3000	1500	TC1,2, OL1,U1	TC1,2, OL1,U1	Handle Version 1 Pole Only
				31 - 50	31 - 50	---	7500	3000	1500	3000	1500	TC1,2, OL0,U1	TC1,2, OL0,U1	Handle Version 1 Pole Only
				0.10 - 30	---	---	7500	3000	1500	3000	1500	TC1,2, OL1,U1	TC1,2, OL1,U1	Rocker Version 1 - 3 Poles
				31 - 32	---	---	7500	3000	1500	3000	1500	TC1,2, OL1,U1	TC1,2, OL1,U1	Rocker Version 2 Pole Only
	250	50 / 60	1	0.10 - 30	---	---	7500	3000	1500	3000	1500	TC1,2, OL0,U1	TC1,2, OL0,U1	Rocker Version 1 Pole Only
				31 - 50	31 - 50	---	7500	3000	1500	3000	1500	TC1,2, OL0,U1	TC1,2, OL0,U1	Rocker Version 1 Pole Only
				0.10 - 30	---	---	3000	3000	1500	5000	1500	TC1,2, OL1,U1	TC1,2, OL1,U1	Rocker Version 1 - 3 Poles
				31 - 50	31 - 50	---	3000	---	---	5000	1500	TC1,2, OL0,U1	TC1,2, OL0,U1	Rocker Version 1 - 3 Poles
				31 - 32	---	---	3000	6000	1500	5000	1500	TC1,2, OL1,U1	TC1,2, OL1,U1	Rocker Version 2 Pole Only
				1	0.10 - 30	---	---	3000	6000	1500	5000	1500	TC1, OL1,U2	TC1, OL1,U2
	3	1 ⁴	1	1 - 30	---	---	1000	---	---	5000	1500	TC1, OL1,U2	TC3, OL1,U3	Rocker Version 1 - 3 Poles
				0.10 - 30	---	5000 ²	---	3000	1500	3000	1500	TC1,2, OL1,C1	TC1,2, OL1,C1	Rocker Version 1 - 3 Poles
	3	3	3	31 - 50	---	2000 ¹	---	3000	1500	3000	1500	TC1,2, OL1,C1	TC1,2, OL1,C1	Rocker Version 1 - 3 Poles
0.10 - 30				---	---	7500	3000	1500	3000	1500	TC1,2, OL1,U1	TC1,2, OL1,U1	Rocker Version 1 - 3 Poles	
DUAL COIL	80	DC	---	0.10 - 30	---	---	7500	3000	1500	3000	1500	TC1,2, OL1,U1	TC1,2, OL1,U1	Rocker Version 1 - 3 Poles
	250	50 / 60	1	0.10 - 30	---	---	3000	3000	1500	5000	1500	TC1,2, OL1,U1	TC1,2, OL1,U1	Rocker Version 1 - 3 Poles
				30 - 50	31 - 50	---	3000	---	---	5000	1500	TC1,2, OL0,U1	TC1,2, OL0,U1	Rocker Version 1 - 3 Poles
				0.10 - 30	---	5000 ²	---	3000	1500	3000	1500	TC1,2, OL1,C1	TC1,2, OL1,C1	Rocker Version 1 - 3 Poles
3	3	3	31 - 50	---	2000 ¹	---	---	---	3000	1500	TC1,2, OL1,C1	TC1,2, OL1,C1	Rocker Version 1 - 3 Poles	
			0.10 - 30	---	---	7500	3000	1500	3000	1500	TC1,2, OL1,U1	TC1,2, OL1,U1	Handle Version 1 Pole Only	
SHUNT	80	DC	---	0.10 - 30	---	---	7500	3000	1500	3000	1500	TC1,2, OL1,U1	TC1,2, OL1,U1	Rocker Version 1 - 3 Poles
				0.10 - 30	---	---	7500	3000	1500	3000	1500	TC1,2, OL1,U1	TC1,2, OL1,U1	Rocker Version 1 - 3 Poles
	250	50 / 60	1	0.10 - 30	---	---	3000	3000	1500	5000	1500	TC1,2, OL1,U1	TC1,2, OL1,U1	Rocker Version 1 - 3 Poles
				30 - 50	31 - 50	---	3000	---	---	5000	1500	TC1,2, OL0,U1	TC1,2, OL0,U1	Rocker Version 1 - 3 Poles
				0.10 - 30	---	5000 ²	---	3000	1500	3000	1500	TC1,2, OL1,C1	TC1,2, OL1,C1	Rocker Version 1 - 3 Poles
				31 - 50	---	2000 ¹	---	---	---	3000	1500	TC1,2, OL1,C1	TC1,2, OL1,C1	Rocker Version 1 - 3 Poles

Notes for Table B:

- 1 General Purpose Ratings for UL/CSA Only.
- 2 Requires branch circuit backup with a UL LISTED Type K5 or RK5 fuse (15A minimum) at no more than 4 times the rating of the protector.
- 3 Same as note 2, except that backup fuse is limited to 80 A maximum.
- 4 Meets the requirements of CSA 22.2 No. 100-04 - Motors and Generators.

Table C: Lists UL Recognized, CSA Accepted configurations and performance capabilities as Protectors, Supplementary for Marine Electrical and Fuel Systems (Guide PEQZ2, File E75596). Ignition Protected per UL 1500. UL Classified Small Craft Electrical Devices, Marine in accordance with ISO 8846 (Guide UZMK, File MQ1515) as Marine Supplementary Protectors.

A-SERIES TABLE C: UL1500 (Marine Ignition Protected)							
CIRCUIT CONFIGURATION	VOLTAGE			CURRENT RATING	SHORT CIRCUIT CAPACITY (AMPS)	APPLICATION CODES	
	MAX. RATING	FREQUENCY	PHASE			UL	CSA
SERIES	14 ¹	DC	---	0.02 - 50	5000	TC1,2,OL1,U1	TC1,2,OL1,U1
	32 ¹	DC	---	0.02 - 50	5000	TC1,2,OL1,U2	TC1,2,OL1,U2
	65	DC	---	0.02 - 50	3000	TC1,2,OL1,U1	TC1,2,OL1,U1
	125 / 250	50 / 60	1 ²	0.02 - 50	1500	TC1,2,OL1,U1	TC1,2,OL1,U1
	250	50 / 60	1	0.02 - 30	1000	TC1,2,OL1,U1	TC1,2,OL1,U1

Notes for Table C:

- 1 Available with special catalog number only (consult factory).
- 2 2 pole protector required (with one pole per power line) for: 250/125 VAC, 125/250 VAC and 208Y/120 VAC Power Systems. 1 pole protector required for: 125 VAC, 1Ø Power System.

Table D: Lists UL Listed configurations and performance capabilities as Circuit Breakers for use in Communications Equipment (Guide DITT, File E189195), under UL489A.

A-SERIES TABLE D: UL489A (COMMUNICATIONS EQUIPMENT)				
CIRCUIT CONFIGURATION	VOLTAGE		CURRENT RATING	INTERRUPTING CAPACITY (AMPS)
	MAX. RATING	FREQUENCY		
SERIES	80	DC	0.10 - 50	5000
	80	DC	60 - 90 ¹	5000

Notes for Table C:

- 1 Parallel Pole Construction

Electrical

Maximum Voltage 277VAC 50/60 Hz, 80VDC
 Current Ratings Standard current coils: 0.100, 0.250, 0.500, 0.750, 1.00, 2.50, 5.00, 7.50, 10.0, 15.0, 20.0, 25.0, 30.0, 35.0, 40.0, 50.0. Other ratings available - consult ordering scheme.
 Standard Voltage Coils DC-6V, 12V; AC-120V, Other ratings available, consult ordering scheme.
 Auxiliary Switch Rating SPDT; 10.1 A - 250VAC, 1.0 A-65VDC/0.5 A - 80 VDC, 0.1A - 125VAC (with gold contacts).
 Insulation Resistance Minimum: 100 Megohms at 500 VDC
 Dielectric Strength UL, CSA - 1500V 60 Hz for one minute between all electrically isolated terminals. A-Series rocker circuit breakers comply with the 8mm spacing & 3750V dielectric requirements from hazardous voltage to operator accessible surfaces per EN 60950 and VDE 0805.
 Resistance, Impedance Values from Line to Load Terminal - based on Series Trip Circuit Breaker.

RESISTANCE, IMPEDANCE VALUES from Line to Load Terminals (Values Based on Series Trip Circuit Breaker)

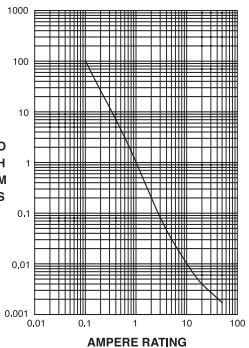

CURRENT (AMPS)	TOLERANCE (%)
0.10 - 5.0	15%
5.1 - 20.0	25%
20.1 - 50.0	35%

Pulse Tolerance Curves

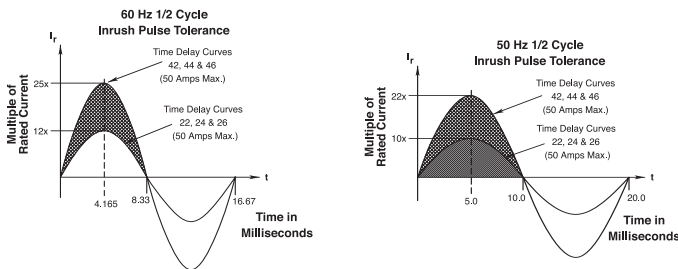

Mechanical

Endurance 10,000 ON-OFF operations @ 6 per minute; with rated Current & Voltage.
 Trip Free All A-Series Circuit Breakers will trip on overload, even when the actuator is forcibly held in the ON position.
 Trip Indication The operating actuator moves positively to the OFF position when an overload causes the circuit breaker to trip. When mid-trip handle is specified, the handle moves to the mid position on electrical trip of the circuit breaker. When mid-trip handle with alarm switch is specified, the handle moves to the mid position & the alarm switch actuates when the circuit breaker is electrically tripped.

Physical

Number of Poles 1 - 6 Poles (handle) and 1-3 poles (rocker) at 30 Amps or less. 1 and 2 poles at 31 Amps thru 50 Amps.
 Internal Circuit Configurations Series, (with or without auxiliary switch), Shunt and Relay with current or voltage trip coils, Dual Coil, Switch Only with or without auxiliary switch.
 Weight Approximately 65 grams/pole. (Approximately 2.32 ounces/pole)
 Standard Colors Housing - Black; Actuator- See Ordering Scheme.

Environmental

Designed and tested in accordance with requirements of specification MIL-PRF-55629 & MIL-STD-202 as follows:
 Shock Withstands 100 Gs, 6ms, sawtooth while carrying rated current per Method 213, Test Condition "I". Instantaneous and ultra-short curves tested @ 90% of rated current.
 Vibration Withstands 0.060" excursion from 10-55 Hz, and 10 Gs 55-500 Hz, at rated current per Method 204C, Test Condition A. Instantaneous and ultrashort curves tested at 90% of rated current.
 Moisture Resistance Method 106D; ten 24-hour cycles @ + 25°C to +65°C, 80-98% RH.56 days @ +85°C, 85% RH.
 Salt Spray Method 101, Condition A (90-95% RH @ 5% NaCl Solution, 96 hrs).
 Thermal Shock Method 107D, Condition A (Five cycles @ -55°C to +25°C to +85°C to +25°C).
 Operating Temperature -40° C to +85° C

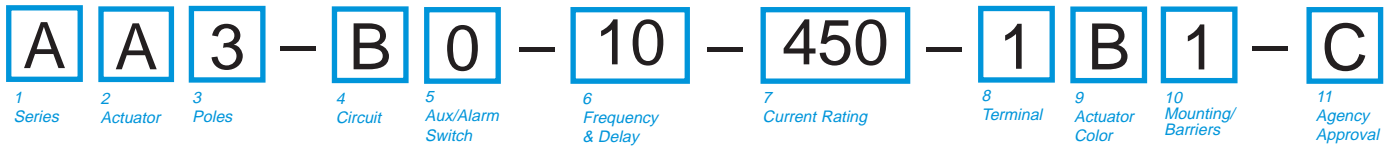

1 SERIES

A

2 ACTUATOR¹

A	Handle, one per pole
B	Handle, one per multipole unit
S	Mid-Trip Handle, one per pole
T	Mid-Trip Handle, one per pole & Alarm Switch

3 POLES

1	One	3	Three	5	Five
2	Two	4	Four	6	Six

4 CIRCUIT

A²	Switch Only (No Coil)	F³	Relay Trip (Current)
B	Series Trip (Current)	G³	Relay Trip (Voltage)
C	Series Trip (Voltage)	H^{3,4}	Dual Coil with Shunt Trip Voltage Coil
D³	Shunt Trip (Current)	K^{3,4}	Dual Coil with Relay Trip Voltage Coil
E³	Shunt Trip (Voltage)		

5 AUXILIARY/ALARM SWITCH⁵

0	w/o Aux Switch	5	S.P.S.T., 0.093 Q.C. Term.(Gold Contacts)
1	S.P.D.T., 0.093 Q.C. Term.	6	S.P.S.T., 0.139 Solder Lug
2	S.P.D.T., 0.110 Q.C. Term.	7	S.P.S.T., 0.110 Q.C. Term.(Gold Contacts)
3	S.P.D.T., 0.139 Solder Lug	8	S.P.S.T., 0.187 Q.C. Term.
4	S.P.D.T., 0.110 Q.C. Term.(Gold Contacts)	9	S.P.D.T., 0.187 Q.C. Term.

6 FREQUENCY & DELAY

03	DC 50/60Hz, Switch Only	30	DC, 50/60Hz Instantaneous
10⁶	DC Instantaneous	31	DC, 50/60Hz Ultra Short
11	DC Ultra Short	32	DC, 50/60Hz Short
12	DC Short	34	DC, 50/60Hz Medium
14	DC Medium	36	DC, 50/60Hz Long
16	DC Long	42⁷	50/60Hz Short, Hi-Inrush
20⁶	50/60Hz Instantaneous	44⁷	50/60Hz Medium, Hi-Inrush
21	50/60Hz Ultra Short	46⁷	50/60Hz Long, Hi-Inrush
22	50/60Hz Short0	52⁷	DC, Short,Hi-Inrush
24	50/60Hz Medium	54⁷	DC,Medium, Hi-Inrush
26	50/60Hz Long	56⁷	DC, Long, Hi-Inrush

- Notes:
- Actuator Code:
A: Handle tie pin spacer(s) and retainers provided unassembled with multi-pole units.
B: Handle location as viewed from front of breaker:
2 pole - left pole 3 pole - center pole
4 pole - two handles at center poles 5 pole - three handles at center poles
6 pole - four handles at center poles
S: Handle moves to mid-position only upon electrical trip of the breaker. Available with circuit codes B, C, D, E, F, G, H and K.
T: Handle moves to mid-position and alarm switch activates only upon electrical trip of the breaker. Available with circuit codes B & C.
 - Switch Only circuits, rated up to 50 amps and 6 poles, and only available with VDE Certification when tied to a protected pole (Circuit Code B, C, D or H.). For .02 to 30 amps, select Current Code 630. For 35 - 50 amps, select Current Code 650.
 - Available with terminal Codes 1, 2 and 3. Current Rating limited to 30 amps maximum.
 - Consult factory for available Dual Coil options, as special catalog number is required. With Shunt construction, Dual Coils will trip instantaneously on line voltage. Dual coils require 30VA minimum power to trip and are rated for intermittent duty only.
 - Auxiliary Switch breakers with Series Trip & Switch Only circuits: ≤ 30A - supplied with standard half shells. 35-50A - supplied with extended boat (B-Style) half shells. On multi-pole breakers, one auxiliary switch is supplied, mounted in the extreme right pole.
 - Separate pole type voltage coils not rated for continuous duty. Available only with delay codes 10 and 20.
 - Available with Circuit Codes B & D only. VDE Certified to 30 amps. UL Recognized, CSA Accepted & TUV Certified to 50 amps.
 - VDE Certification available with single pole breakers with DC Delay only. UL Recognition and CSA Accepted available in one and two pole breakers.
 - Screw Terminals are recommended on ratings greater than 20 amps. Ratings over 30 amps are only available with Terminal Codes 5, 9, G, H, M and Q..
 - Terminal Code 1: VDE Certification up to 25 amps and UL Recognition and CSA Certification up to 30 amps, but not recommended over 20 amps.
 - Terminal Codes 3, 5, E and H (Bus Type) with VDE, are supplied with Lock Washers, and Terminal Code M (M6 Threaded Stud) with VDE is supplied with Lock and Flat Washers. These breakers are only VDE Certified when the washers are used.
 - Terminal Code L: VDE Certified available up to 12A. UL Recognized & CSA Accepted available up to 30A.
 - Single pole breakers with Terminal Code P (Printed Circuit Board) are available up to 30 amps with VDE Certification and 50 amps with UL Recognition and CSA Accepted, with Circuit Codes A, B and C. Two pole breakers with Terminal Code P (Printed Circuit Board) are available up to 40 amps with UL Recognition and CSA Accepted with Circuit Codes A, B and C.
 - Terminal Code Q not available with VDE certification.
 - Single pole only.

7 CURRENT RATING (AMPERES)

020	0.020	225	0.250	420	2.000	611	11.000
025	0.025	230	0.300	522	2.250	711	11.500
030	0.030	235	0.350	527	2.750	612	12.000
035	0.035	240	0.400	430	3.000	712	12.500
040	0.040	245	0.450	435	3.500	613	13.000
045	0.045	250	0.500	440	4.000	614	14.000
050	0.050	255	0.550	445	4.500	615	15.000
055	0.055	260	0.600	450	5.000	616	16.000
060	0.060	265	0.650	455	5.500	617	17.000
065	0.065	270	0.700	460	6.000	618	18.000
070	0.070	275	0.750	465	6.500	620	20.000
075	0.075	280	0.800	470	7.000	622	22.000
080	0.080	285	0.850	475	7.500	624	24.000
085	0.085	290	0.900	480	8.000	625	25.000
090	0.090	295	0.950	485	8.500	630	30.000
095	0.095	410	1.000	490	9.000	635⁹	35.000
210	0.100	512	1.250	495	9.500	640⁹	40.000
215	0.150	415	1.500	610	10.000	645⁹	45.000
220	0.200	517	1.750	710	10.500	650⁹	50.000

OR VOLTAGE COIL (NOMINAL RATED VOLTAGE)⁶

A06	6 DC	A32	32 DC	J12	12 AC	J65	65 AC
A12	12 DC	A48	48 DC	J18	18 AC	K20	120 AC
A18	18 DC	A65	65 DC	J24	24 AC	L40	240 AC
A24	24 DC	J06	6 AC	J48	48 AC		

8 TERMINAL⁹

1¹⁰	Push-On 0.250 Tab (Q.C.)	E¹¹	Screw M4 (Bus Type)
2	Screw 8-32 w/upturned lugs	F	Screw M5 w/upturned lugs and 30° bend
3¹¹	Screw 8-32 (Bus Type)	G	Screw M5 (Bus Type) and 30° bend
4	Screw 10-32 w/upturned lugs	H¹¹	Screw M5 (Bus Type)
5¹¹	Screw 10-32 (Bus Type)	L¹²	0.250 Q.C./ Solder Lug
6	Screw 8-32 w/upturned lugs and 30° bend	M¹¹	M6 Threaded Stud
7	Screw 8-32 (Bus Type) and 30° bend	Q¹⁴	Push-In Stud
8	Screw 10-32 w/upturned lugs and 30° bend	R	Screw M4 w/upturned lugs and 30° bend
9	Screw 10-32 (Bus Type) and 30° bend	T¹¹	Screw M4 (Bus Type) and 30° bend
B	Screw M5 w/upturned lugs	P¹³	Printed Circuit Board Terminals
C	Screw M4 w/upturned lugs	S¹³	Push-On 0.110 Tab (Q.C.)

9 ACTUATOR COLOR & LEGEND

Actuator Color	I-O	ON-OFF	Dual	Legend Color
White	A	B	1	Black
Black	C	D	2	White
Red	F	G	3	White
Green	H	J	4	White
Blue	K	L	5	White
Yellow	M	N	6	Black
Gray	P	Q	7	Black
Orange	R	S	8	Black
Black (short handle) ¹⁵	T	U	9	White

10 MOUNTING/BARRIERS

	MOUNTING STYLE	BARRIERS
	Threaded Inserts, 2 per pole	
1	6-32 x 0.195 inches	no
A	6-32 X 0.195 inches	yes
2	ISO M3 x 5mm	no
B	ISO M3 x 5mm (multipole only)	yes
5	Front panel Snap-In, 0.75" wide bezel without Handleguard	no
6	without Handleguard (multipole only)	yes
7	Front panel Snap-In, 0.96" wide bezel without Handleguard, 1-pole 0.96" wide; multipole units have .105" bezel overhang on all sides	no
8	without Handleguard, 1-pole 0.96" wide; (multipole only) .105" bezel overhang on all sides	yes

11 AGENCY APPROVAL

C	UL Recognized & CSA Accepted
D	VDE Certified, UL Recognized & CSA Accepted
E	TUV Certified, UL Recognized & CSA Accepted
I	UL Rec. STD 1077, UL Rec. 1500 (ignition protected), & CSA Accepted

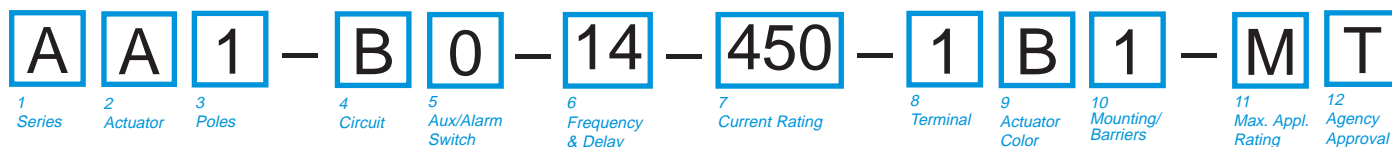

1 SERIES
A

2 ACTUATOR¹
A Handle, one per pole
S Mid-Trip Handle, one per pole
T Mid-Trip Handle, one per pole & Alarm Switch

3 POLES²
1 One 2 Two 3 Three 4 Four

4 CIRCUIT
B Series Trip (Current)

5 AUXILIARY/ALARM SWITCH²

0	w/o Aux Switch	7	S.P.S.T., 0.110 Q.C.
1	S.P.D.T., 0.093 Q.C. Term.		Term.(Gold Contacts)
2	S.P.D.T., 0.110 Q.C. Term.	8	S.P.S.T., 0.187 Q.C. Term.
3	S.P.D.T., 0.139 Solder Lug	9	S.P.D.T., 0.187 Q.C. Term.

6 FREQUENCY & DELAY

11	DC Ultra Short	52 ³	DC, Short, Hi-Inrush
12	DC Short	54 ³	DC, Medium, Hi-Inrush
14	DC Medium	56 ³	DC, Long, Hi-Inrush
16	DC Long		

7 CURRENT RATING (AMPERES)

210	0.100	415	1.500	710	10.500
215	0.150	517	1.750	611	11.000
220	0.200	420	2.000	711	11.500
225	0.250	522	2.250	612	12.000
230	0.300	527	2.750	712	12.500
235	0.350	430	3.000	613	13.000
240	0.400	435	3.500	614	14.000
245	0.450	440	4.000	615	15.000
250	0.500	445	4.500	616	16.000
255	0.550	450	5.000	617	17.000
260	0.600	455	5.500	618	18.000
265	0.650	460	6.000	620	20.000
270	0.700	465	6.500	622	22.000
275	0.750	470	7.000	624	24.000
280	0.800	475	7.500	625	25.000
285	0.850	480	8.000	630	30.000
290	0.900	485	8.500	635 ⁴	35.000
295	0.950	490	9.000	640 ⁴	40.000
410	1.000	495	9.500	645 ⁴	45.000
512	1.250	610	10.000	650 ⁴	50.000

8 TERMINAL⁵

1 ⁶	Push-On 0.250 Tab (Q.C.)	9	Screw 10-32 (Bus Type) and 30° bend
2	Screw 8-32 w/upturned lugs	B	Screw M5 w/upturned lugs
3 ⁷	Screw 8-32 (Bus Type)	F	Screw M5 w/upturned lugs and 30° bend
4	Screw 10-32 w/upturned lugs	G	Screw M5 (Bus Type) and 30° bend
5 ⁷	Screw 10-32 (Bus Type)	H	Screw M5 (Bus Type)
6	Screw 8-32 w/upturned lugs and 30° bend	M ⁷	M6 Threaded Stud
7	Screw 8-32 (Bus Type) and 30° bend	P ⁸	Printed Circuit Board Terminals
8	Screw 10-32 w/upturned lugs and 30° bend	Q ⁹	Push-In Stud

9 ACTUATOR COLOR

LEGEND			
	ON-OFF	Dual	Legend Color
White	B	1	Black
Black	D	2	White
Red	G	3	White
Green	J	4	White
Blue	L	5	White
Yellow	N	6	Black
Gray	Q	7	Black
Orange	S	8	Black
Black (short handle) ¹⁰	U	9	White

10 MOUNTING/BARRIERS

MOUNTING STYLE	BARRIERS
Threaded Insert, 2 per pole	
1 6-32 x 0.195 inches	no
A 6-32 X 0.195 inches	yes
2 ISO M3 x 5mm	no
B ISO M3 x 5mm (multipole only)	yes
Front panel Snap-In, 0.75" wide bezel	
5 without Handleguard	no
6 without Handleguard (multipole only)	yes
Front panel Snap-In, 0.96" wide bezel	
7 without Handleguard, 1-pole 0.96" wide; multipole units have .105" bezel overhang on all sides	no
8 without Handleguard, 1-pole 0.96" wide; (multipole only) .105" bezel overhang on all sides	yes

11 MAXIMUM APPLICATION RATING
M 80 DC

12 AGENCY APPROVAL
T UL489A LISTED
K UL489A LISTED, VDE CERTIFIED
J UL489A LISTED, TUV CERTIFIED

Notes:
1 Actuator Code:
A: Handle tie pin spacer(s) and retainers provided unassembled with multi-pole units.
S: Handle moves to mid-position only upon electrical trip of the breaker.
T: Handle moves to mid-position and alarm switch activates only upon electrical trip of the breaker.
2 On multi-pole breakers, one auxiliary switch is supplied, mounted in the extreme right pole.
3 VDE Certified to 30 amps. UL489A Listed to 50 amps.
4 VDE Certification available with single pole breakers only. UL489A Listing available with one and two pole breakers.
5 Screw Terminals are recommended on ratings greater than 20 amps. Ratings over 30 amps are only available with Terminal Codes 5, 9 G, H, M and Q.
6 Terminal Code 1 (Push-On) available up to 25 amps with VDE Certification and 30 amps with UL489A Listing, but is not recommended over 20 amps.
7 Terminal Codes 3, 5 and H (Bus Type) with VDE, are supplied with Lock Washers, and Terminal Code M (M6 Threaded Stud) with VDE is supplied with Lock and Flat Washers. These breakers are only VDE Certified when the washers are used.
8 Single pole breakers with Terminal Code P (Printed Circuit Board) are available up to 30 amps with VDE Certification and 50 amps with UL489A Listing.
9 Terminal Code Q not available with VDE certification.
10 Single pole only.

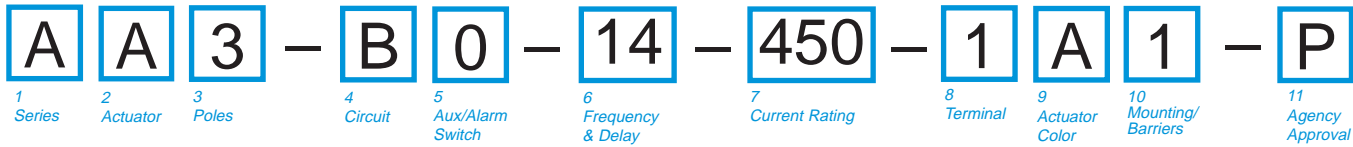

1 SERIES	
A	
2 ACTUATOR¹	
A	Handle, one per pole
S	Mid-Trip Handle, one per pole
T	Mid-Trip Handle, one per pole & Alarm Switch
3 POLES	
1	One
2	Two
3	Three
4	Four
5	Five
6	Six
4 CIRCUIT	
A ²	Switch Only (No Coil)
B	Series Trip (Current)
C	Series Trip (Voltage)
D ³	Shunt Trip (Current)
E ³	Shunt Trip (Voltage)
H ^{3,4}	Dual Coil with Shunt Trip Voltage Coil
5 AUXILIARY/ALARM SWITCH⁵	
0	w/o Aux Switch
2	S.P.D.T., 0.110 Q.C. Term.
3	S.P.D.T., 0.139 Solder Lug
4	S.P.D.T., 0.110 Q.C. Term. (Gold Contacts)
6 FREQUENCY & DELAY	
03	DC 50/60Hz, Switch Only
10 ⁶	DC Instantaneous
11	DC Ultra Short
12	DC Short
14	DC Medium
16	DC Long
20 ⁶	50/60Hz Instantaneous
21	50/60Hz Ultra Short
22	50/60Hz Short0
24	50/60Hz Medium
26	50/60Hz Long
30	DC, 50/60Hz Instantaneous
31	DC, 50/60Hz Ultra Short
32	DC, 50/60Hz Short
34	DC, 50/60Hz Medium
36	DC, 50/60Hz Long
42 ⁷	50/60Hz Short, Hi-Inrush
44 ⁷	50/60Hz Medium, Hi-Inrush
46 ⁷	50/60Hz Long, Hi-Inrush
52 ⁷	DC, Short, Hi-Inrush
54 ⁷	DC, Medium, Hi-Inrush
56 ⁷	DC, Long, Hi-Inrush

7 CURRENT RATING (AMPERES)							
210	0.100	285	0.850	455	5.500	613	13.000
215	0.150	290	0.900	460	6.000	614	14.000
220	0.200	295	0.950	465	6.500	615	15.000
225	0.250	410	1.000	470	7.000	616	16.000
230	0.300	512	1.250	475	7.500	617	17.000
235	0.350	415	1.500	480	8.000	618	18.000
240	0.400	517	1.750	485	8.500	620	20.000
245	0.450	420	2.000	490	9.000	622	22.000
250	0.500	522	2.250	495	9.500	624	24.000
255	0.550	527	2.750	610	10.000	625	25.000
260	0.600	430	3.000	710	10.500	630	30.000
265	0.650	435	3.500	611	11.000	635 ⁸	35.000
270	0.700	440	4.000	711	11.500	640 ⁸	40.000
275	0.750	445	4.500	612	12.000	645 ⁸	45.000
280	0.800	450	5.000	712	12.500	650 ⁸	50.000
OR VOLTAGE COIL (NOMINAL RATED VOLTAGE)⁸							
A06	6 DC	A32	32 DC	J12	12 AC	J65	65 AC
A12	12 DC	A48	48 DC	J18	18 AC	K20	120 AC
A18	18 DC	A65	65 DC	J24	24 AC	L40	240 AC
A24	24 DC	J06	6 AC	J48	48 AC		

8 TERMINAL⁹		B Screw M5 w/upturned lugs	
1 ¹⁰	Push-On 0.250 Tab (Q.C.)	C	Screw M4 w/upturned lugs
2	Screw 8-32 w/upturned lugs	E	Screw M4 (Bus Type)
3 ¹¹	Screw 8-32 (Bus Type)	F	Screw M5 w/upturned lugs and 30° bend
4	Screw 10-32 w/upturned lugs	G	Screw M5 (Bus Type) and 30° bend
5 ¹¹	Screw 10-32 (Bus Type)	H	Screw M5 (Bus Type)
6	Screw 8-32 w/upturned lugs and 30° bend	R	Screw M4 w/upturned lugs and 30° bend
7	Screw 8-32 (Bus Type) and 30° bend	T	Screw M4 (Bus Type) and 30° bend
8	Screw 10-32 w/upturned lugs and 30° bend		
9	Screw 10-32 (Bus Type) and 30° bend		

9 ACTUATOR COLOR & LEGEND			
Actuator Color	I-O	Dual	Legend Color
White	A	1	Black
Black	C	2	White
Red	F	3	White
Green	H	4	White
Blue	K	5	White
Yellow	M	6	Black
Gray	P	7	Black
Orange	R	8	Black

10 MOUNTING/BARRIERS		
MOUNTING STYLE		
<i>Threaded Inserts, 2 per pole</i>		
1	6-32 x 0.195 inches	no
A	6-32 X 0.195 inches	yes
2	ISO M3 x 5mm	no
B	ISO M3 x 5mm (multipole only)	yes
<i>Front panel Snap-In, 0.75" wide bezel</i>		
5	without Handleguard	no
6	without Handleguard (multipole only)	yes
<i>Front panel Snap-In, 0.96" wide bezel</i>		
7	without Handleguard, 1-pole 0.96" wide; multipole units have .105" bezel overhang on all sides	no
8	without Handleguard, 1-pole 0.96" wide; (multipole only) .105" bezel overhang on all sides	yes

11 AGENCY APPROVAL	
P	TUV Certified, UL Recognized & CSA Accepted
Q	UL Rec. STD 1077, UL Rec. 1500 (ignition protected), & CSA Accepted

Notes:

- Actuator Code:
A: Handle tie pin spacer(s) and retainers provided unassembled with multi-pole units.
S: Handle moves to mid-position only upon electrical trip of the breaker. Available with circuit codes B, C, D, E, and H.
T: Handle moves to mid-position and alarm switch activates only upon electrical trip of the breaker. Available with circuit codes B & C.
- Switch Only circuits, rated up to 50 amps and 6 poles, and only available when tied to a protected pole (Circuit Code B, C, D or H.), For .01 to 30 amps, select Current Code 630. For 35 - 50 amps, select Current Code 650.
- Available with terminal Codes 1, 2 and 3. Current Rating limited to 30 amps maximum. Consult factory for available Dual Coil options, as special catalog number is required.
- With Shunt construction, Dual Coils will trip instantaneously on line voltage. Dual coils require 30VA minimum power to trip and are rated for intermittent duty only.
- On multi-pole breakers, one auxiliary switch is supplied, mounted in the extreme right pole.
- Separate pole type voltage coils not rated for continuous duty. Available only with delay codes 10, 20 & 30.
- Available with Circuit Codes B & D only. VDE Certified to 30 amps. UL Recognized, CSA Accepted & TUV Certified to 50 amps.
- Available up to two poles with AC or DC delays.
- Screw Terminals are recommended on ratings greater than 20 amps. Ratings over 30 amps are only available with Terminal Codes 5, 9, G and H.
- Terminal Code 1: TUV Certification up to 30 amps, but not recommended over 20 amps.
- Terminal Codes 3, 5, 7, 9, E, G and H (Bus Type) are supplied with Lock Washers. These breakers are ONLY TUV Certified when the washers are used.

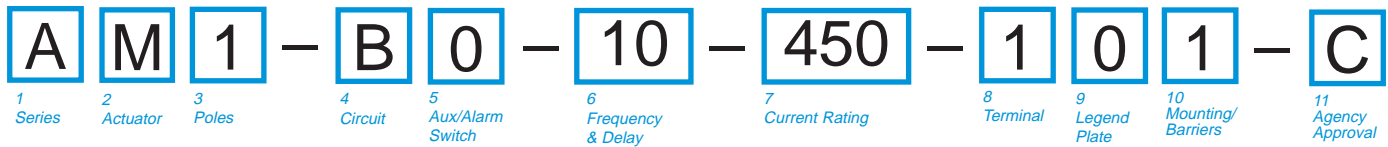

1 SERIES	
A	
2 ACTUATOR¹	
M Sealed Toggle, one per unit	
3 POLES	
1	One
2	Two
3	Three
4 CIRCUIT	
A ²	Switch Only (No Coil)
B	Series Trip (Current)
C	Series Trip (Voltage)
D ³	Shunt Trip (Current)
E ³	Shunt Trip (Voltage)
F ³	Relay Trip (Current)
G ³	Relay Trip (Voltage)
H ^{3,4}	Dual Coil with Shunt Trip Voltage Coil
K ^{3,4}	Dual Coil with Relay Trip Voltage Coil
5 AUXILIARY/ALARM SWITCH⁵	
0	w/o Aux Switch
1	S.P.D.T., 0.093 Q.C. Term.
2	S.P.D.T., 0.110 Q.C. Term.
3	S.P.D.T., 0.139 Solder Lug
4	S.P.D.T., 0.110 Q.C. Term. (Gold Contacts)
5	S.P.S.T., 0.093 Q.C. Term.(Gold Contacts)
6	S.P.S.T., 0.139 Solder Lug
7	S.P.S.T., 0.110 Q.C. Term.(Gold Contacts)
8	S.P.S.T., 0.187 Q.C. Term.
9	S.P.D.T., 0.187 Q.C. Term.
6 FREQUENCY & DELAY	
03	DC 50/60Hz, Switch Only
10 ⁶	DC Instantaneous
11	DC Ultra Short
12	DC Short
14	DC Medium
16	DC Long
20 ⁶	50/60Hz Instantaneous
21	50/60Hz Ultra Short
22	50/60Hz Short0
24	50/60Hz Medium
26	50/60Hz Long
30	DC, 50/60Hz Instantaneous
31	DC, 50/60Hz Ultra Short
32	DC, 50/60Hz Short
34	DC, 50/60Hz Medium
36	DC, 50/60Hz Long
42 ⁷	50/60Hz Short, Hi-Inrush
44 ⁷	50/60Hz Medium, Hi-Inrush
46 ⁷	50/60Hz Long, Hi-Inrush
52 ⁷	DC, Short,Hi-Inrush
54 ⁷	DC,Medium, Hi-Inrush
56 ⁷	DC, Long, Hi-Inrush

7 CURRENT RATING (AMPERES)							
020	0.020	225	0.250	420	2.000	611	11.000
025	0.025	230	0.300	522	2.250	711	11.500
030	0.030	235	0.350	527	2.750	612	12.000
035	0.035	240	0.400	430	3.000	712	12.500
040	0.040	245	0.450	435	3.500	613	13.000
045	0.045	250	0.500	440	4.000	614	14.000
050	0.050	255	0.550	445	4.500	615	15.000
055	0.055	260	0.600	450	5.000	616	16.000
060	0.060	265	0.650	455	5.500	617	17.000
065	0.065	270	0.700	460	6.000	618	18.000
070	0.070	275	0.750	465	6.500	620	20.000
075	0.075	280	0.800	470	7.000	622	22.000
080	0.080	285	0.850	475	7.500	624	24.000
085	0.085	290	0.900	480	8.000	625	25.000
090	0.090	295	0.950	485	8.500	630	30.000
095	0.095	410	1.000	490	9.000	635*	35.000
210	0.100	512	1.250	495	9.500	640*	40.000
215	0.150	415	1.500	610	10.000	645*	45.000
220	0.200	517	1.750	710	10.500	650*	50.000
OR VOLTAGE COIL (NOMINAL RATED VOLTAGE)⁶							
A06	6 DC	A32	32 DC	J12	12 AC	J65	65 AC
A12	12 DC	A48	48 DC	J18	18 AC	K20	120 AC
A18	18 DC	A65	65 DC	J24	24 AC	L40	240 AC
A24	24 DC	J06	6 AC	J48	48 AC		

8 TERMINAL⁸		E	Screw M4 (Bus Type)
1 ¹⁰	Push-On 0.250 Tab (Q.C.)	F	Screw M5 w/upturned lugs and 30° bend
2	Screw 8-32 w/upturned lugs	G	Screw M5 (Bus Type) and 30° bend
3	Screw 8-32 (Bus Type)	H	Screw M5 (Bus Type)
4	Screw 10-32 w/upturned lugs	L ¹¹	0.250 Q.C./ Solder Lug
5	Screw 10-32 (Bus Type)	M	M6 Threaded Stud
6	Screw 8-32 w/upturned lugs and 30° bend	Q	Push-In Stud
7	Screw 8-32 (Bus Type) and 30° bend	R	Screw M4 w/upturned lugs and 30° bend
8	Screw 10-32 w/upturned lugs and 30° bend	T	Screw M4 (Bus Type) and 30° bend
9	Screw 10-32 (Bus Type) and 30° bend	P ¹²	Printed Circuit Board Terminals
B	Screw M5 w/upturned lugs	S ¹²	Push-On 0.110 Tab (Q.C.)
C	Screw M4 w/upturned lugs		

9 LEGEND PLATE	
0	No legend plate

10 MOUNTING/BARRIERS		
MOUNTING STYLE		BARRIERS
1	Standard Hex Nut	no
A	Standard Hex Nut (multipole only)	yes

11 AGENCY APPROVAL	
C	UL Recognized & CSA Accepted

- Notes:
- Actuator Code M: Handle location as viewed from front of panel:
2 pole - right pole 3 pole - center pole
 - Switch Only circuits, rated up to 50 amps and 3 poles. For .02 to 30 amps, select Current Code 630. For 35 - 50 amps, select Current Code 650.
 - Available with terminal Codes 1, 2 and 3. Current Rating limited to 30 amps maximum.
 - Consult factory for available Dual Coil options, as special catalog number is required. With Shunt construction, Dual Coils will trip instantaneously on line voltage. Dual coils require 30VA minimum power to trip and are rated for intermittent duty only.
 - Auxiliary Switch available on Series Trip & Switch Only circuits, limited to 30 amps. On multi-pole breakers, one auxiliary switch is supplied, mounted in the extreme right pole.
 - Voltage coils not rated for continuous duty. Available only with delay codes 10 and 20.
 - Available with Circuit Codes B & D only. VDE Certified to 30 amps. UL Recognized, CSA Accepted & TUV Certified to 50 amps.
 - UL Recognition and CSA Certification available on one and two pole breakers.
 - Screw Terminals are recommended on ratings greater than 20 amps. Ratings over 30 amps are only available with Terminal Codes 5, 9, G, H, M and Q..
 - Terminal Code 1: UL Recognition and CSA Certification up to 30 amps, but not recommended over 20 amps.
 - Terminal Code L : available up to 30A.
 - Single pole breakers with Terminal Code P (Printed Circuit Board) are available up to 50 amps, with Circuit Codes A, B and C. Two pole breakers with Terminal Code P (Printed Circuit Board) are available up to 40 amps with Circuit Codes A, B and C.

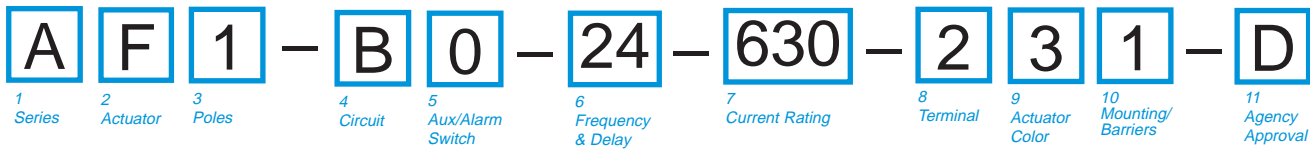

1 SERIES
A

2 ACTUATOR ¹

Two Color Visi-Rocker

- C Indicate ON, vertical legend
- D Indicate ON, horizontal legend
- E Indicate ON, no legend
- F Indicate OFF, vertical legend
- G Indicate OFF, horizontal legend
- H Indicate OFF, no legend

Push-To-Reset, Single color

- R Vertical legend
- U Horizontal legend
- V No legend

Push-To-Reset, Visi-Rocker

- N Indicate OFF, vertical legend
- O Indicate OFF, horizontal legend
- P Indicate OFF, no legend

Single color

- J Vertical legend
- K Horizontal legend
- L No legend

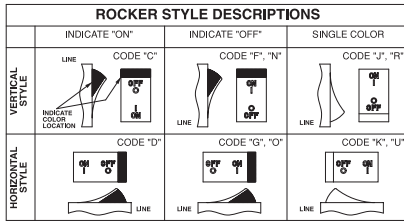

3 POLES²

- 1 One
- 2 Two
- 3 Three

4 CIRCUIT

- A³ Switch Only (No Coil)
- B Series Trip (Current)
- C Series Trip (Voltage)
- D⁴ Shunt Trip (Current)
- E⁴ Shunt Trip (Voltage)
- F⁴ Relay Trip (Current)
- G⁴ Relay Trip (Voltage)
- H^{4,5} Dual Coil with Shunt Trip Voltage Coil
- K^{4,5} Dual Coil with Relay Trip Voltage Coil

5 AUXILIARY/ALARM SWITCH^{6,7}

- 0 w/o Aux Switch
- 1 S.P.D.T., 0.093 Q.C. Term.
- 2 S.P.D.T., 0.110 Q.C. Term.
- 3 S.P.D.T., 0.139 Solder Lug
- 4 S.P.D.T., 0.110 Q.C. Term. (Gold Contacts)
- 5 S.P.S.T., 0.093 Q.C. Term. (Gold Contacts)
- 6 S.P.S.T., 0.139 Solder Lug
- 7 S.P.S.T., 0.110 Q.C. Term. (Gold Contacts)
- 8 S.P.S.T., 0.187 Q.C. Term.
- 9 S.P.D.T., 0.187 Q.C. Term.

6 FREQUENCY & DELAY

- 03 DC 50/60Hz, Switch Only
- 08 DC Instantaneous
- 11 DC Ultra Short
- 12 DC Short
- 14 DC Medium
- 16 DC Long
- 20⁸ 50/60Hz Instantaneous
- 21 50/60Hz Ultra Short
- 22 50/60Hz Short
- 24 50/60Hz Medium
- 26 50/60Hz Long
- 30 DC, 50/60Hz Instantaneous
- 31 DC, 50/60Hz Ultra Short
- 32 DC, 50/60Hz Short
- 34 DC, 50/60Hz Medium
- 36 DC, 50/60Hz Long
- 42⁹ 50/60Hz Short, Hi-Inrush
- 44⁹ 50/60Hz Medium, Hi-Inrush
- 46⁹ 50/60Hz Long, Hi-Inrush
- 52⁹ DC, Short, Hi-Inrush
- 54⁹ DC, Medium, Hi-Inrush
- 56 DC, Long, Hi-Inrush

Notes:
 1 Push-To-Reset actuators have OFF portion of rocker shrouded.
 2 Multi-pole breakers have all breakers identical except when specifying Aux. switch and/or mixed poles, and have one rocker per breaker.
 3 Switch Only circuits, rated up to 50 amps & 3 poles, are available with VDE Certification when tied to a protected pole (Circuit Code B, C, D or H). For .02 to 30 amps, select Current Code 630. For 35 - 50 amps, select Current Code 650.
 4 Available with terminal Codes 1, 2 and 3. Current Rating limited to 30 amps maximum.
 5 Consult factory for Dual Coil options, as special catalog number is required. With Shunt construction, Dual Coils will trip instantaneously on line voltage. Dual coils require 30VA minimum power to trip and are rated for intermittent duty only.
 6 Auxiliary Switch breakers with Series Trip & Switch Only circuits: ≤ 30A, are supplied with standard half shells. 30-50A are supplied with extended boat (B-Style) half shells.
 7 On multi-pole breakers, one aux. switch is supplied, mounted in the extreme right pole.
 8 Separate pole type voltage coils not rated for continuous duty. Available only with delay codes 10 and 20.
 9 Available with Circuit Codes B & D only. VDE Certified to 30 amps. UL Recognized, CSA Accepted & TUV Certified to 50 amps.
 10 Series Trip current ratings: VDE Certification available with single pole breakers with DC Delay only. UL Recognition & CSA Accepted available in one and two pole breakers.
 11 Screw Terminals are recommended on ratings greater than 20 amps. Ratings over 30 amps are only available with Terminal Codes 5, 9, G, H, M and Q.
 12 Terminal Code 1: VDE Certification up to 25 amps and UL Recognition and CSA Accepted up to 30 amps, but not recommended over 20 amps.
 13 Terminal Codes 3, 5 E & H (Bus Type) with VDE, are supplied with Lock Washers; Terminal Code M (M6 Threaded Stud) with VDE is supplied with Lock and Flat Washers. These breakers are only VDE Certified when the washers are used. VDE Cert. available up to 12 amps. UL Rec. & CSA Accepted available up to 30 amps.
 14 Single pole breakers with Terminal Code P (Printed Circuit Board) are available up to 30 amps with VDE Certification and 50 amps with UL Recognition and CSA Accepted, with Circuit Codes A, B and C. Two pole breakers with Terminal Code P (Printed Circuit Board) are available up to 40 amps with UL Recognition and CSA Certification with Circuit Codes A, B and C.
 15 Terminal Code Q not available with VDE.
 16 Terminal Code S used on voltage coil circuit constructions only.
 17 Color shown is visi and legend with remainder of rocker black.
 18 Dual = ON-OFF/I-O legend with actuator. None = no legend on actuator
 19 Legend on Push-to-reset bezel/shroud is white with single color actuator codes R, & U. Legend on Push-to-reset bezel/shroud matches Visi-color of rocker with actuator codes N & O. Rockerguard available with actuator codes C through L.
 20

7 CURRENT RATING (AMPERES)

020	0.020	225	0.250	420	2.000	611	11.000
025	0.025	230	0.300	522	2.250	711	11.500
030	0.030	235	0.350	527	2.750	612	12.000
035	0.035	240	0.400	430	3.000	712	12.500
040	0.040	245	0.450	435	3.500	613	13.000
045	0.045	250	0.500	440	4.000	614	14.000
050	0.050	255	0.550	445	4.500	615	15.000
055	0.055	260	0.600	450	5.000	616	16.000
060	0.060	265	0.650	455	5.500	617	17.000
065	0.065	270	0.700	460	6.000	618	18.000
070	0.070	275	0.750	465	6.500	620	20.000
075	0.075	280	0.800	470	7.000	622	22.000
080	0.080	285	0.850	475	7.500	624	24.000
085	0.085	290	0.900	480	8.000	625	25.000
090	0.090	295	0.950	485	8.500	630	30.000
095	0.095	410	1.000	490	9.000	635 ¹⁰	35.000
210	0.100	512	1.250	495	9.500	640 ¹⁰	40.000
215	0.150	415	1.500	610	10.000	645 ¹⁰	45.000
220	0.200	517	1.750	710	10.500	650 ¹⁰	50.000

OR VOLTAGE COIL (NOMINAL RATED VOLTAGE)

A06	6 DC	A32	32 DC	J12	12 AC	J65	65 AC
A12	12 DC	A48	48 DC	J18	18 AC	K20	120 AC
A18	18 DC	A65	65 DC	J24	24 AC	L40	240 AC
A24	24 DC	J06	6 AC	J48	48 AC		

8 TERMINAL ¹¹

- 1¹² Push-On 0.250 Tab (Q.C.)
- 2 Screw 8-32 w/upturned lugs
- 3¹³ Screw 8-32 (Bus Type)
- 4 Screw 10-32 w/upturned lugs
- 5¹³ Screw 10-32 (Bus Type)
- 6 Screw 8-32 w/upturned lugs and 30° bend
- 7 Screw 8-32 (Bus Type) and 30° bend
- 8 Screw 10-32 w/upturned lugs and 30° bend
- 9 Screw 10-32 (Bus Type) and 30° bend
- B Screw M5 w/upturned lugs
- C Screw M4 w/upturned lugs
- E¹³ Screw M4 (Bus Type)
- F Screw M5 w/upturned lugs and 30° bend
- G Screw M5 (Bus Type) and 30° bend
- H¹³ Screw M5 (Bus Type)
- L¹⁴ 0.250 Q.C./ Solder Lug
- M¹³ M6 Threaded Studs
- P¹⁵ Printed Circuit Board Terminals
- Q¹⁶ Push-In Stud
- R Screw M4 w/upturned lugs and 30° bend
- S¹⁷ Push-On 0.110 Tab (Q.C.)
- T Screw M4 (Bus Type) and 30° bend

9 ACTUATOR COLOR & LEGEND

Actuator or Visi-Color ¹²	Marking:			Marking Color:	
	I-O	ON-OFF	Dual ¹²	Single Color	Visi-Rocker
White	A	B	1	Black	White
Black	C	D	2	White	n/a
Red	F	G	3	White	Red
Green	H	J	4	White	Green
Blue	K	L	5	White	Blue
Yellow	M	N	6	Black	Yellow
Gray	P	Q	7	Black	Gray
Orange	R	S	8	Black	Orange

10 MOUNTING/BARRIERS²⁰

	BARRIERS	
STANDARD ROCKER BEZEL, Threaded Insert, 2 per pole		
1	6-32 x 0.195 inches	no
A	6-32 X 0.195 inches (multi-pole units only)	yes
2	ISO M3 x 5mm	no
B	ISO M3 x 5mm (multi-pole units only)	yes
ROCKERGUARD & PUSH-TO-RESET BEZEL, Threaded Insert, 2 per pole		
3	6-32 x 0.195 inches	no
C	6-32 x 0.195 inches (multi-pole units only)	yes
4	ISO M3 x 5mm	no
D	ISO M3 x 5mm (multi-pole units only)	yes
FRONT PANEL SNAP-IN BRACKET, 0.744" wide bezel		
8	without Rockerguard (single pole units only)	no
H	with Rockerguard (single pole units only)	no
FRONT PANEL SNAP-IN BRACKET, 0.96" wide bezel		
9	without Rockerguard (single pole units only)	no
J	with Rockerguard (single pole units only)	no

11 AGENCY APPROVAL

- C UL Recognized & CSA Accepted
- D VDE Certified, UL Recognized & CSA Accepted
- E TUV Certified, UL Recognized & CSA Accepted
- I UL Rec. STD 1077, UL Rec. 1500 (ignition protected), & CSA Accepted

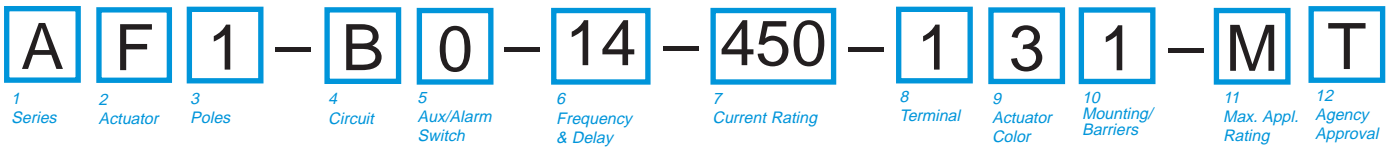

1 SERIES

A

2 ACTUATOR¹

Two Color Visi-Rocker

Push-To-Reset, Visi-Rocker

- C** Indicate ON, vertical legend
- D** Indicate ON, horizontal legend
- F** Indicate OFF, vertical legend
- G** Indicate OFF, horizontal legend

- N** Indicate OFF, vertical legend
- O** Indicate OFF, horizontal legend

Single color

Push-To-Reset, Single color

- J** Vertical legend
- K** Horizontal legend

- R** Vertical legend
- U** Horizontal legend

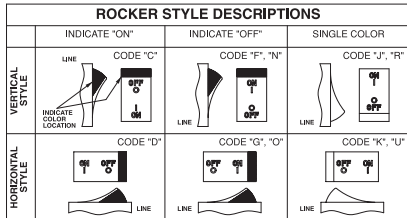

3 POLES²

- 1 One 2 Two 3 Three

4 CIRCUIT

B Series Trip (Current)

5 AUXILIARY/ALARM SWITCH³

- | | |
|-------------------------------------|-------------------------------------|
| 0 w/o Aux Switch | 7 S.P.S.T., 0.110 Q.C. |
| 1 S.P.D.T., 0.093 Q.C. Term. | Term.(Gold Contacts) |
| 2 S.P.D.T., 0.110 Q.C. Term. | 8 S.P.S.T., 0.187 Q.C. Term. |
| 3 S.P.D.T., 0.139 Solder Lug | 9 S.P.D.T., 0.187 Q.C. Term. |

6 FREQUENCY & DELAY

- | | |
|--------------------------|---------------------------------|
| 11 DC Ultra Short | 52 DC, Short, Hi-Inrush |
| 12 DC Short | 54 DC, Medium, Hi-Inrush |
| 14 DC Medium | 56 DC, Long, Hi-Inrush |
| 16 DC Long | |

7 CURRENT RATING (AMPERES)

210	0.100	415	1.500	710	10.500
215	0.150	517	1.750	611	11.000
220	0.200	420	2.000	711	11.500
225	0.250	522	2.250	612	12.000
230	0.300	527	2.750	712	12.500
235	0.350	430	3.000	613	13.000
240	0.400	435	3.500	614	14.000
245	0.450	440	4.000	615	15.000
250	0.500	445	4.500	616	16.000
255	0.550	450	5.000	617	17.000
260	0.600	455	5.500	618	18.000
265	0.650	460	6.000	620	20.000
270	0.700	465	6.500	622	22.000
275	0.750	470	7.000	624	24.000
280	0.800	475	7.500	625	25.000
285	0.850	480	8.000	630	30.000
290	0.900	485	8.500	635 ⁵	35.000
295	0.950	490	9.000	640 ⁵	40.000
410	1.000	495	9.500	645 ⁵	45.000
512	1.250	610	10.000	650 ⁵	50.000

8 TERMINAL⁵

- | | |
|---|--|
| <ul style="list-style-type: none"> 1⁶ Push-On 0.250 Tab (Q.C.) 2 Screw 8-32 w/upturned lugs 3⁷ Screw 8-32 (Bus Type) 4 Screw 10-32 w/upturned lugs 5⁷ Screw 10-32 (Bus Type) 6 Screw 8-32 w/upturned lugs and 30° bend 7 Screw 8-32 (Bus Type) and 30° bend 8 Screw 10-32 w/upturned lugs and 30° bend | <ul style="list-style-type: none"> 9 Screw 10-32 (Bus Type) and 30° bend B Screw M5 w/upturned lugs F Screw M5 w/upturned lugs and 30° bend G Screw M5 (Bus Type) and 30° bend H Screw M5 (Bus Type) M⁷ M6 Threaded Stud P⁸ Printed Circuit Board Terminals Q⁹ Push-In Stud |
|---|--|

9 ACTUATOR COLOR & LEGEND

Actuator or Visi-Color¹⁰

	Marking		Marking Color:	
	ON-OFF	Dual ¹⁰	Single Color	Visi-Rocker
White	B	1	Black	White
Black	D	2	White	n/a
Red	G	3	White	Red
Green	J	4	White	Green
Blue	L	5	White	Blue
Yellow	N	6	Black	Yellow
Gray	Q	7	Black	Gray
Orange	S	8	Black	Orange

10 MOUNTING/BARRIERS¹¹

	STANDARD ROCKER BEZEL Threaded Insert, 2 per pole	BARRIERS
1	6-32 x 0.195 inches	no
A	6-32 X 0.195 inches (multi-pole units only)	yes
2	ISO M3 x 5mm	no
B	ISO M3 x 5mm (multi-pole units only)	yes
	ROCKERGUARD & PUSH-TO-RESET BEZEL Threaded Insert, 2 per pole	
3	6-32 x 0.195 inches	no
C	6-32 x 0.195 inches (multi-pole units only)	yes
4	ISO M3 x 5mm	no
D	ISO M3 x 5mm (multi-pole units only)	yes
	FRONT PANEL SNAP-IN BRACKET, 0.744" [18.90mm] wide bezel	
8	without Rockerguard (single pole units only)	no
H	with Rockerguard (single pole units only)	no
	FRONT PANEL SNAP-IN BRACKET, 0.96" [24.48mm] wide bezel	
9	without Rockerguard (single pole units only)	no
J	with Rockerguard (single pole units only)	no

11 MAXIMUM APPLICATION RATING

M 80 DC

12 AGENCY APPROVAL

- T** UL489A Listed
- K** UL489A Listed, VDE Certified
- J** UL489A Listed, TUV Certified

Notes:

- 1 Push-To-Reset actuators have OFF portion of rocker shrouded.
- 2 Multi-pole breakers have all breakers identical except when specifying Aux. switch and/or mixed poles, and have one rocker per breaker.
- 3 Auxiliary Switch breakers with Series Trip circuits: ≤ 30A, are supplied with standard half shells. 30-50A are supplied with extended boat (B-Style) half shells.
- 4 VDE Certification available with single pole breakers only. UL489A Listing available with one and two pole breakers.
- 5 Screw Terminals are recommended on ratings greater than 20 amps. Ratings over 30 amps are only available with Terminal Codes 5, 9, G, H, M and Q.
- 6 Terminal Code 1 (Push-On) available up to 25 amps with TUV or VDE Certification and 30 amps with UL489A Listing, but is not recommended over 20 amps.
- 7 Terminal Codes 3, 5 and H (Bus Type) with TUV or VDE, are supplied with Lock Washers, and Terminal Code M (M6 Threaded Stud) with VDE is supplied with Lock and Flat Washers. These breakers are only TUV or VDE Certified when the washers are used.
- 8 Single pole breakers with Terminal Code P (Printed Circuit Board) are available up to 30 amps with VDE Certification and 50 amps with UL489A Listing.
- 9 Terminal Code Q not available with VDE certification.
- 10 Color shown is Visi and Legend with remainder of rocker black. Dual = ON-OFF/-O legend.
- 11 Legend on Push-to-reset bezel/shroud is white with single color actuator codes R & U. Legend on Push-To-Reset bezel/shroud matches Visi-Color of rocker with actuator codes N & O. Rockerguard available with actuator codes C through K.

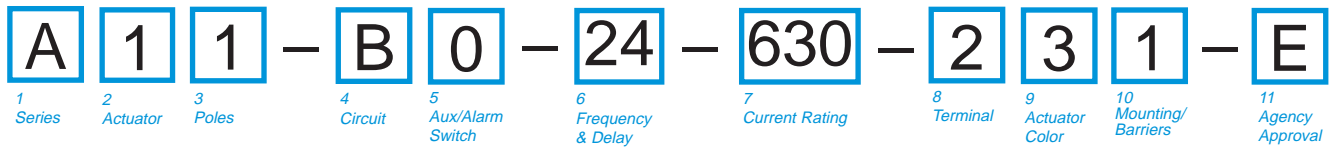

1 SERIES
A

2 ACTUATOR ¹
Two Color Visi-Rocker
 1 Indicate OFF, vertical legend
 2 Indicate OFF, horizontal legend
Single color
 3 Vertical legend
 4 Horizontal legend
Push-To-Reset, Visi-Rocker
 5 Indicate OFF, vertical legend
 6 Indicate OFF, horizontal legend
Push-To-Reset, Single color
 7 Vertical legend
 8 Horizontal legend

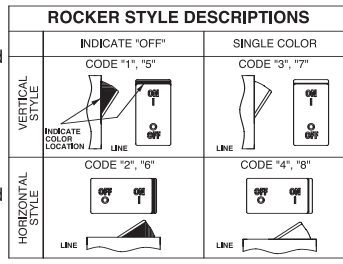

3 POLES²
 1 One 2 Two 3 Three

4 CIRCUIT

A ³ Switch Only (No Coil)	F ⁴ Relay Trip (Current)
B Series Trip (Current)	G ⁴ Relay Trip (Voltage)
C Series Trip (Voltage)	H ^{4,5} Dual Coil with Shunt Trip Voltage Coil
D ⁴ Shunt Trip (Current)	K ^{4,5} Dual Coil with Relay Trip Voltage Coil
E ⁴ Shunt Trip (Voltage)	

5 AUXILIARY/ALARM SWITCH^{6,7}

0 w/o Aux Switch	5 S.P.S.T., 0.093 Q.C. Term.(Gold Contacts)
1 S.P.D.T., 0.093 Q.C. Term.	6 S.P.S.T., 0.139 Solder Lug
2 S.P.D.T., 0.110 Q.C. Term.	7 S.P.S.T., 0.110 Q.C. Term.(Gold Contacts)
3 S.P.D.T., 0.139 Solder Lug	8 S.P.S.T., 0.187 Q.C. Term.
4 S.P.D.T., 0.110 Q.C. Term. (Gold Contacts)	9 S.P.D.T., 0.187 Q.C. Term.

6 FREQUENCY & DELAY

03 DC 50/60Hz, Switch Only	30 DC, 50/60Hz Instantaneous
10 ⁸ DC Instantaneous	31 DC, 50/60Hz Ultra Short
11 DC Ultra Short	32 DC, 50/60Hz Short
12 DC Short	34 DC, 50/60Hz Medium
14 DC Medium	36 DC, 50/60Hz Long
16 DC Long	42 ⁹ 50/60Hz Short, Hi-Inrush
20 ⁸ 50/60Hz Instantaneous	44 ⁹ 50/60Hz Medium, Hi-Inrush
21 50/60Hz Ultra Short	46 ⁹ 50/60Hz Long, Hi-Inrush
22 50/60Hz Short	52 ⁹ DC, Short, Hi-Inrush
24 50/60Hz Medium	54 ⁹ DC, Medium, Hi-Inrush
26 50/60Hz Long	56 DC, Long, Hi-Inrush

- Notes:
- 1 Push-To-Reset actuators have OFF portion of rocker shrouded.
 - 2 Multi-pole breakers have all breakers identical except when specifying Aux. switch and/or mixed poles, and have one rocker per breaker.
 - 3 Switch Only circuits, rated up to 50 amps & 3 poles. For .02 to 30 amps, select Current Code 630. For 35 - 50 amps, select Current Code 650.
 - 4 Available with terminal Codes 1, 2 and 3. Current Rating limited to 30 amps maximum.
 - 5 Consult factory for Dual Coil options, as special catalog number is required. With Shunt construction, Dual Coils will trip instantaneously on line voltage. Dual coils require 30VA minimum power to trip and are rated for intermittent duty only.
 - 6 Auxiliary Switch breakers with Series Trip & Switch Only circuits: ≤ 30A, are supplied with standard half shells. 30-50A are supplied with extended boat (B-Style) half shells.
 - 7 On multi-pole breakers, one aux. switch is supplied, mounted in the extreme right pole.
 - 8 Separate pole type voltage coils not rated for continuous duty. Available only with delay codes 10 & 20.
 - 9 Available with Circuit Codes B & D only, UL Recognized, CSA Accepted & TUV Certified to 50 amps.
 - 10 UL Recognition, CSA Acceptance & TUV Certification available in one and two pole breakers.
 - 11 Screw Terminals are recommended on ratings greater than 20 amps. Ratings over 30 amps are only available with Terminal Codes 5, 9, G, H, M and Q.
 - 12 Terminal Code 1: Available up to 30 amps, but not recommended over 20 amps.
 - 13 Terminal Codes 3, 5 E & H (Bus Type) with TUV, are supplied with Lock Washers; Terminal Code M (M6 Threaded Stud) with TUV is supplied with Lock and Flat Washers. These breakers are only TUV Certified when the washers are used.
 - 14 TUV Cert. available up to 12 amps. UL Rec. & CSA Accepted available up to 30 amps.
 - 15 Single pole breakers with Terminal Code P (Printed Circuit Board) are available up to 50 amps with UL Recognition, CSA Accepted & TUV Certification, with Circuit Codes A, B and C. Two pole breakers with Terminal Code P (Printed Circuit Board) are available up to 40 amps with UL Recognition and CSA Accepted with Circuit Codes A, B and C.
 - 16 Terminal Code S used on voltage coil circuit constructions only.
 - 17 Color shown is visi and legend with remainder of rocker black, Dual = ON-OFF/I-O legend.
 - 18 Legend on Push-to-reset bezel/shroud is white with single color actuator codes 7 & 8. Legend on Push-To-Reset bezel/shroud matches Visi-Color of rocker with actuator codes 5 & 6.
 - 19 Recessed "off-side" available with actuator codes 1, 2, 3 & 4. Legends on rocker are available in ink stamping only.

7 CURRENT RATING (AMPERES)

020 0.020	225 0.250	420 2.000	611 11.000
025 0.025	230 0.300	522 2.250	711 11.500
030 0.030	235 0.350	527 2.750	612 12.000
035 0.035	240 0.400	430 3.000	712 12.500
040 0.040	245 0.450	435 3.500	613 13.000
045 0.045	250 0.500	440 4.000	614 14.000
050 0.050	255 0.550	445 4.500	615 15.000
055 0.055	260 0.600	450 5.000	616 16.000
060 0.060	265 0.650	455 5.500	617 17.000
065 0.065	270 0.700	460 6.000	618 18.000
070 0.070	275 0.750	465 6.500	620 20.000
075 0.075	280 0.800	470 7.000	622 22.000
080 0.080	285 0.850	475 7.500	624 24.000
085 0.085	290 0.900	480 8.000	625 25.000
090 0.090	295 0.950	485 8.500	630 30.000
095 0.095	410 1.000	490 9.000	635 ¹⁰ 35.000
210 0.100	512 1.250	495 9.500	640 ¹⁰ 40.000
215 0.150	415 1.500	610 10.000	645 ¹⁰ 45.000
220 0.200	517 1.750	710 10.500	650 ¹⁰ 50.000

OR VOLTAGE COIL (NOMINAL RATED VOLTAGE)

A06 6 DC	A32 32 DC	J12 12 AC	J65 65 AC
A12 12 DC	A48 48 DC	J18 18 AC	K20 120 AC
A18 18 DC	A65 65 DC	J24 24 AC	L40 240 AC
A24 24 DC	J06 6 AC	J48 48 AC	

8 TERMINAL ¹¹

1 ¹² Push-On 0.250 Tab (Q.C.)	E ¹³ Screw M4 (Bus Type)
2 Screw 8-32 w/upturned lugs	F Screw M5 w/upturned lugs and 30° bend
3 ¹³ Screw 8-32 (Bus Type)	G Screw M5 (Bus Type) and 30° bend
4 Screw 10-32 w/upturned lugs	H ¹³ Screw M5 (Bus Type)
5 ¹³ Screw 10-32 (Bus Type)	L ¹⁴ 0.250 Q.C./ Solder Lug
6 Screw 8-32 w/upturned lugs and 30° bend	M ¹³ M6 Threaded Studs
7 Screw 8-32 (Bus Type) and 30° bend	P ¹⁵ Printed Circuit Board Terminals
8 Screw 10-32 w/upturned lugs and 30° bend	Q Push-In Stud
9 Screw 10-32 (Bus Type) and 30° bend	R Screw M4 w/upturned lugs and 30° bend
B Screw M5 w/upturned lugs	S ¹⁶ Push-On 0.110 Tab (Q.C.)
C Screw M4 w/upturned lugs	T Screw M4 (Bus Type) and 30° bend

9 ACTUATOR COLOR & LEGEND

Actuator or Visi-Color ¹⁷	Marking:			Marking Color:	
I-O	ON-OFF	Dual ¹⁷	Single Color	Visi-Rocker	
White	A	B	1	Black	White
Black	C	D	2	White	n/a
Red	F	G	3	White	Red
Green	H	J	4	White	Green
Blue	K	L	5	White	Blue
Yellow	M	N	6	Black	Yellow
Gray	P	Q	7	Black	Gray
Orange	R	S	8	Black	Orange

10 MOUNTING/BARRIERS¹⁸

	BARRIERS
STANDARD ROCKER BEZEL, Threaded Insert, 2 per pole	
FLAT ROCKER ACTUATOR	
1 6-32 x 0.195 inches	no
A 6-32 X 0.195 inches (multi-pole units only)	yes
2 ISO M3 x 5mm	no
B ISO M3 x 5mm (multi-pole units only)	yes
RECESSED OFF SIDE ROCKER ACTUATOR ¹⁹	
5 6-32 x 0.195 inches	no
E 6-32 x 0.195 inches (multi-pole units only)	yes
6 ISO M3 x 5mm	no
F ISO M3 x 5mm (multi-pole units only)	yes
PUSH-TO-RESET BEZEL, Threaded Insert, 2 per pole	
3 6-32 x 0.195 inches	no
C 6-32 x 0.195 inches (multi-pole units only)	yes
4 ISO M3 x 5mm	no
D ISO M3 x 5mm (multi-pole units only)	yes

11 AGENCY APPROVAL

C	UL Recognized & CSA Accepted
E	TUV Certified, UL Recognized & CSA Accepted
I	UL Rec. STD 1077, UL Rec. 1500 (ignition protected), & CSA Accepted

A **1** **1** – **B** **0** – **14** – **630** – **2** **3** **1** – **M** **T**

1 Series 2 Actuator 3 Poles 4 Circuit 5 Aux/Alarm Switch 6 Frequency & Delay 7 Current Rating 8 Terminal 9 Actuator Color 10 Mounting/Barriers 11 Max. Appl. Rating 12 Agency Approval

1 SERIES
A

2 ACTUATOR¹
Two Color Visi-Rocker
1 Indicate OFF, vertical legend
2 Indicate OFF, horizontal legend
Single color
3 Vertical legend
4 Horizontal legend
Push-To-Reset, Visi-Rocker
5 Indicate OFF, vertical legend
6 Indicate OFF, horizontal legend
Push-To-Reset, Single color
7 Vertical legend
8 Horizontal legend

ROCKER STYLE DESCRIPTIONS	
	INDICATE "OFF"
VERTICAL STYLE	CODE "1", "5"
	CODE "3", "7"
HORIZONTAL STYLE	CODE "2", "6"
	CODE "4", "8"

3 POLES²
1 One 2 Two 3 Three

4 CIRCUIT
B Series Trip (Current)

5 AUXILIARY/ALARM SWITCH^{3,4}

0 w/o Aux Switch	7 S.P.S.T., 0.110 Q.C. Term.(Gold Contacts)
1 S.P.D.T., 0.093 Q.C. Term.	8 S.P.S.T., 0.187 Q.C. Term.
2 S.P.D.T., 0.110 Q.C. Term.	9 S.P.D.T., 0.187 Q.C. Term.
3 S.P.D.T., 0.139 Solder Lug	

6 FREQUENCY & DELAY

11 DC Ultra Short	52 DC, Short, Hi-Inrush
12 DC Short	54 DC, Medium, Hi-Inrush
14 DC Medium	56 DC, Long, Hi-Inrush
16 DC Long	

7 CURRENT RATING (AMPERES)

210 0.100	285 0.850	455 5.500	613 13.000
215 0.150	290 0.900	460 6.000	614 14.000
220 0.200	295 0.950	465 6.500	615 15.000
225 0.250	410 1.000	470 7.000	616 16.000
230 0.300	512 1.250	475 7.500	617 17.000
235 0.350	415 1.500	480 8.000	618 18.000
240 0.400	517 1.750	485 8.500	620 20.000
245 0.450	420 2.000	490 9.000	622 22.000
250 0.500	522 2.250	495 9.500	624 24.000
255 0.550	527 2.750	610 10.000	625 25.000
260 0.600	430 3.000	710 10.500	630 30.000
265 0.650	435 3.500	611 11.000	635 ⁵ 35.000
270 0.700	440 4.000	711 11.500	640 ⁵ 40.000
275 0.750	445 4.500	612 12.000	645 ⁵ 45.000
280 0.800	450 5.000	712 12.500	650 ⁵ 50.000

8 TERMINAL⁶

1 ⁷ Push-On 0.250 Tab (Q.C.)	B Screw M5 w/upturned lugs
2 Screw 8-32 w/upturned lugs	C Screw M4 w/upturned lugs
3 ⁸ Screw 8-32 (Bus Type)	F Screw M5 w/upturned lugs and 30° bend
4 Screw 10-32 w/upturned lugs	G Screw M5 (Bus Type) and 30° bend
5 ⁸ Screw 10-32 (Bus Type)	H ⁸ Screw M5 (Bus Type)
6 Screw 8-32 w/upturned lugs and 30° bend	M ⁶ M6 Threaded Studs
7 Screw 8-32 (Bus Type) and 30° bend	P ⁹ Printed Circuit Board Terminals
8 Screw 10-32 w/upturned lugs and 30° bend	Q ¹⁰ Push-In Stud
9 Screw 10-32 (Bus Type) and 30° bend	

9 ACTUATOR COLOR & LEGEND
Actuator or Visi-Color¹¹

	Marking		Marking Color:	
	ON-OFF	Dual ¹¹	Single Color	Visi-Rocker
White	B	1	Black	White
Black	D	2	White	n/a
Red	G	3	White	Red
Green	J	4	White	Green
Blue	L	5	White	Blue
Yellow	N	6	Black	Yellow
Gray	Q	7	Black	Gray
Orange	S	8	Black	Orange

10 MOUNTING/BARRIERS¹²

	BARRIERS
STANDARD ROCKER BEZEL, Threaded Insert, 2 per pole	
FLAT ROCKER ACTUATOR	
1 6-32 x 0.195 inches	no
A 6-32 X 0.195 inches (multi-pole units only)	yes
2 ISO M3 x 5mm	no
B ISO M3 x 5mm (multi-pole units only)	yes
RECESSED OFF SIDE ROCKER ACTUATOR¹³	
5 6-32 x 0.195 inches	no
E 6-32 x 0.195 inches (multi-pole units only)	yes
6 ISO M3 x 5mm	no
F ISO M3 x 5mm (multi-pole units only)	yes
PUSH-TO-RESET BEZEL, Threaded Insert, 2 per pole	
3 6-32 x 0.195 inches	no
C 6-32 x 0.195 inches (multi-pole units only)	yes
4 ISO M3 x 5mm	no
D ISO M3 x 5mm (multi-pole units only)	yes

11 MAXIMUM APPLICATION RATING
M 80 DC

12 AGENCY APPROVAL
T UL489A Listed
J UL489A Listed, TUV Certified

- Notes:
- 1 Push-To-Reset actuators have OFF portion of rocker shrouded.
 - 2 Multi-pole breakers have all breakers identical except when specifying Aux. switch and/or mixed poles, and have one rocker per breaker.
 - 3 Auxiliary Switch breakers with Series Trip circuits: ≤ 30A, are supplied with standard half shells. 30-50 amps are supplied with extended boat (B-Style) half shells.
 - 4 On multi-pole breakers, one aux. switch is supplied, mounted in the extreme right pole.
 - 5 VDE Certification available with single pole breakers only. UL489A Listing available with one and two pole breakers.
 - 6 Screw Terminals are recommended on ratings greater than 20 amps. Ratings over 30 amps are only available with Terminal Codes 5, 9 G, H, M and Q.
 - 7 Terminal Code 1 (Push-On) available up to 25 amps with VDE Certification and 30 amps with UL489A Listing, but is not recommended over 20 amps.
 - 8 Terminal Codes 3, 5 and H (Bus Type) with TUV or VDE, are supplied with Lock Washers, and Terminal Code M (M6 Threaded Stud) with VDE is supplied with Lock and Flat Washers. These breakers are only TUV or VDE Certified when the washers are used.
 - 9 Single pole breakers with Terminal Code P (Printed Circuit Board) are available up to 30 amps with VDE Certification and 50 amps with UL489A Listing.
 - 10 Terminal Code Q not available with VDE certification.
 - 11 Color shown is visi and legend with remainder of rocker black, Dual = ON-OFF/I-O legend.
 - 12 Legend on Push-to-reset bezel/shroud is white with single color actuator codes 7 & 8. Legend on Push-To-Reset bezel/shroud matches Visi-Color of rocker with actuator codes 5 & 6.
 - 13 Recessed "off-side" available with actuator codes 1, 2, 3 & 4. Legends on rocker are available in ink stamping only.

CIRCUIT BREAKER PROFILE	CIRCUIT SCHEMATIC		CIRCUIT SCHEMATIC			
	ANSI	CIRCUIT CODE	ANSI	CIRCUIT CODE		
2 TERMINALS 	SWITCH ONLY (NO COIL) 	A	0	SERIES TRIP 	BC	0
5 TERMINALS 	SWITCH ONLY (NO COIL) WITH AUXILIARY SWITCH 	A	1 2 3 4	SERIES TRIP WITH (3) AUXILIARY/ALARM SWITCH 	BC	1 2 3 4
3 TERMINALS 	SHUNT TRIP 	DE	0	DUAL COIL; SERIES TRIP CURRENT COIL, SHUNT TRIP VOLTAGE COIL 	H	0
4 TERMINALS 	RELAY TRIP 	FG	0	DUAL COIL; SERIES TRIP CURRENT COIL, RELAY TRIP VOLTAGE COIL 	K	0

AUXILIARY/ALARM SWITCH TERMINAL DETAIL

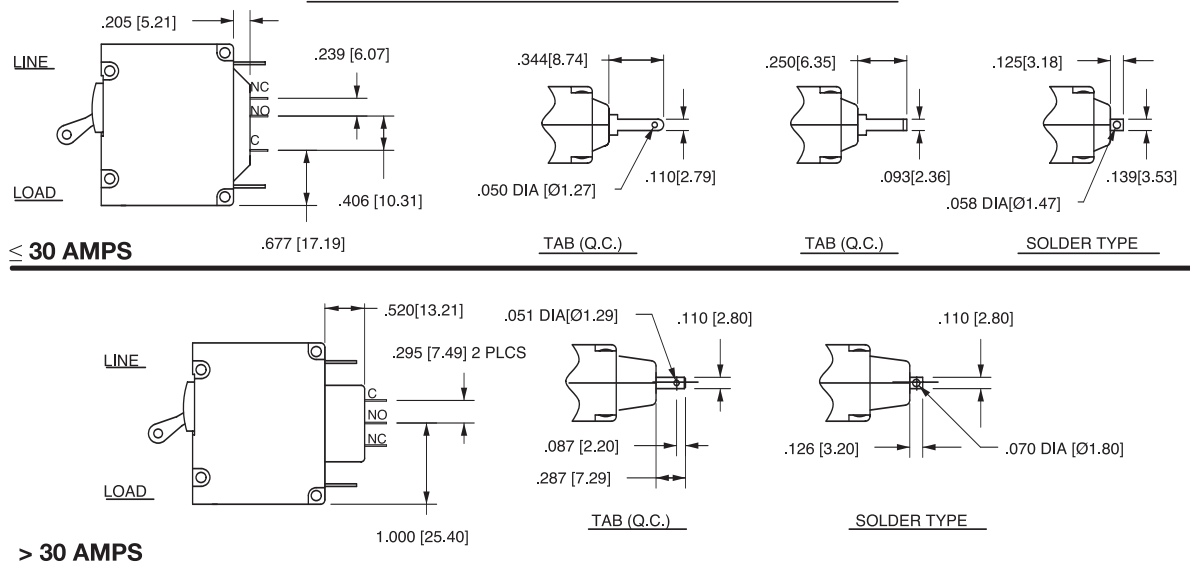

- Notes:
- All dimensions are in inches [millimeters].
 - Tolerance $\pm .020$ [.51] unless otherwise specified.
 - Alarm Switch available with .110 x .020 Q.C. & Solder Lug Terminals Only.

HANDLE POSITION VS. AUX/ALARM SWITCH MODE						
CIRCUIT BREAKER MODE	STANDARD C/B		MID TRIP C/B		MID TRIP C/B	
	HANDLE POSITION	AUX. SWITCH MODE	HANDLE POSITION	ALARM SWITCH MODE	HANDLE POSITION	AUX. SWITCH MODE (w/o ALARM SWITCH)
OFF						
ON						
ELECTRICAL TRIP						

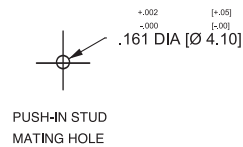
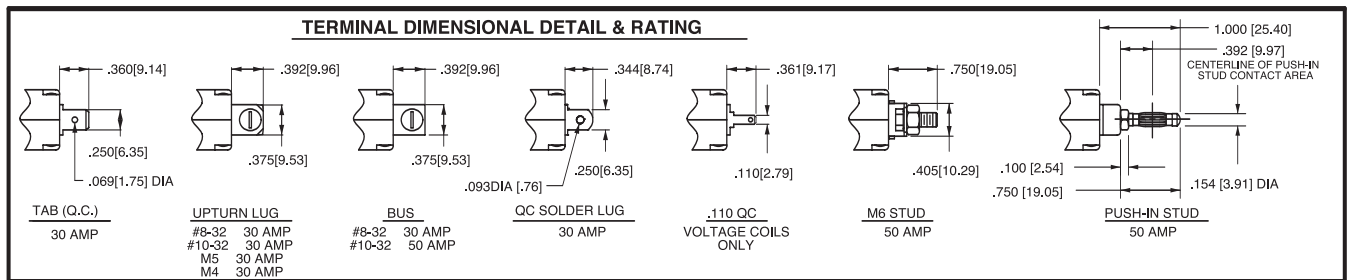

TABLE A TIGHTENING TORQUE SPECIFICATIONS

THREAD SIZE	TORQUE
#6-32 & M3 MOUNTING HARDWARE	7-9 IN-LBS [0.8-1.0 NM]
#8-32 & M4 THREAD TERMINAL SCREW	12-15 IN-LBS [1.4-1.7 NM]
#10-32 & M5 THREAD TERMINAL SCREW	15-20 IN-LBS [1.7-2.3 NM]

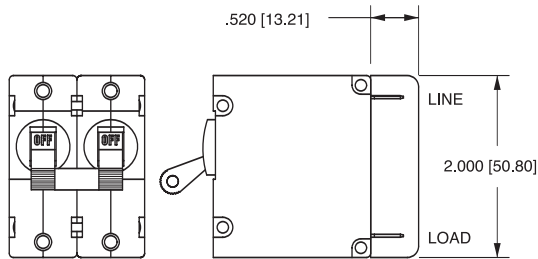
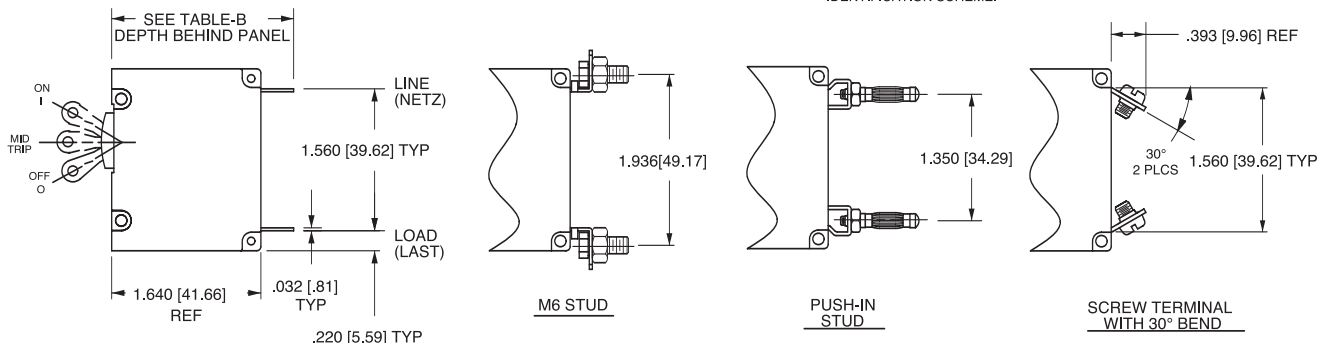

TABLE B

TERMINAL DESCRIPTION		DEPTH BEHIND PANEL
MAIN	TAB (Q.C.)	2.000 [50.80]
	SCREW TYPE	2.032 [51.60]
SHUNT, RELAY & DUAL COIL	TAB (Q.C.)	2.207 [56.10]
	SCREW #8-32 W/UPTURNED LUGS	2.364 [60.05]
AUX. SWITCH*	.093 TAB (Q.C.)	2.095 [53.20]
	.110 TAB (Q.C.)	2.189 [55.60]
	SOLDER TYPE	1.970 [50.00]

* AVAILABLE ON SERIES TRIP AND SWITCH ONLY CIRCUITS. WHEN CALLED FOR ON MULTI-POLE UNITS, ONLY ONE AUX. SWITCH IS NORMALLY SUPPLIED, AS SHOWN IN MULTI-POLE IDENTIFICATION SCHEME.



- Notes:
- All dimensions are in inches [millimeters].
 - Tolerance ±.020 [.51] unless otherwise specified.
 - Alarm Switch available with .110 x .020 QC & solder lug terminals only.

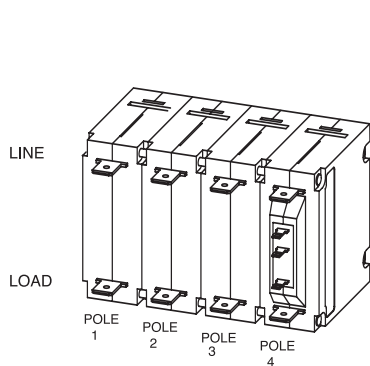
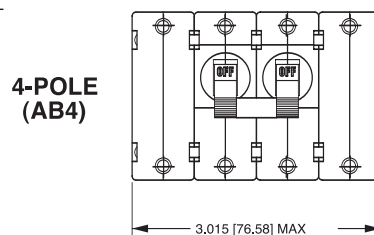
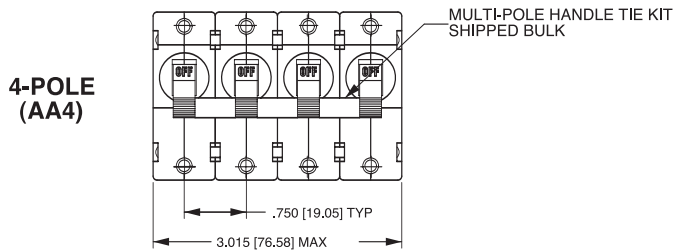
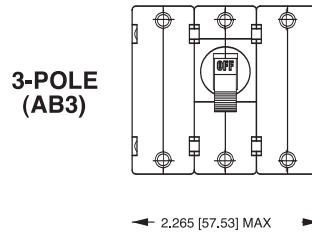
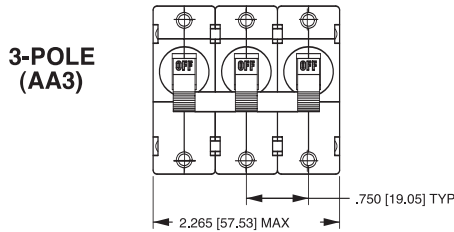
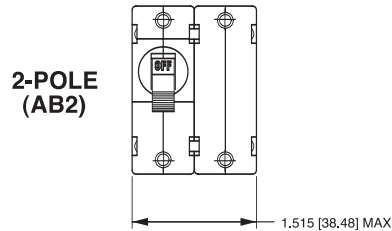
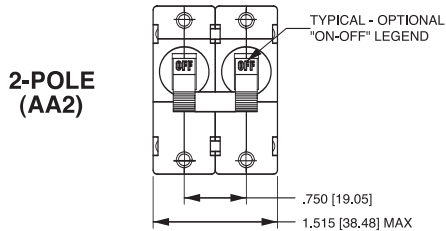
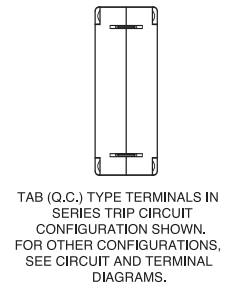
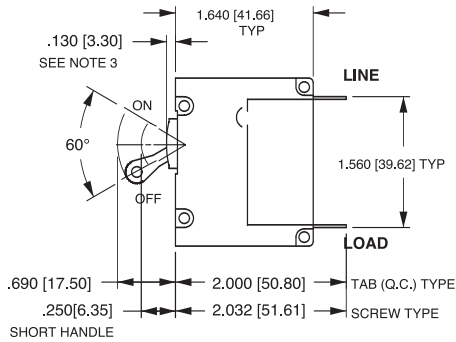
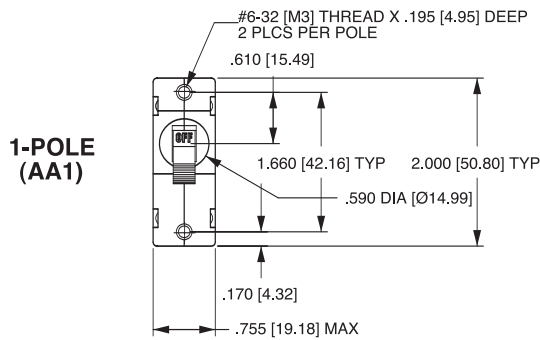

MULTI-POLE IDENTIFICATION SCHEME AS VIEWED FROM TERMINAL END OF BREAKER.

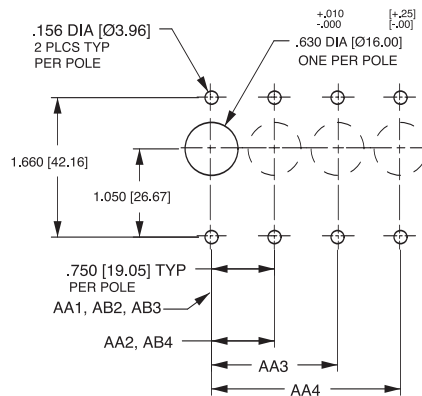

PANEL CUTOUT DETAIL
TOLERANCES ±.005 [±.12] UNLESS OTHERWISE SPECIFIED

- Notes:
- 1 All dimensions are in inches [millimeters].
 - 2 Tolerance ± 0.20 [.51] unless otherwise specified.
 - 3 For agency code P = .150 [3.81].

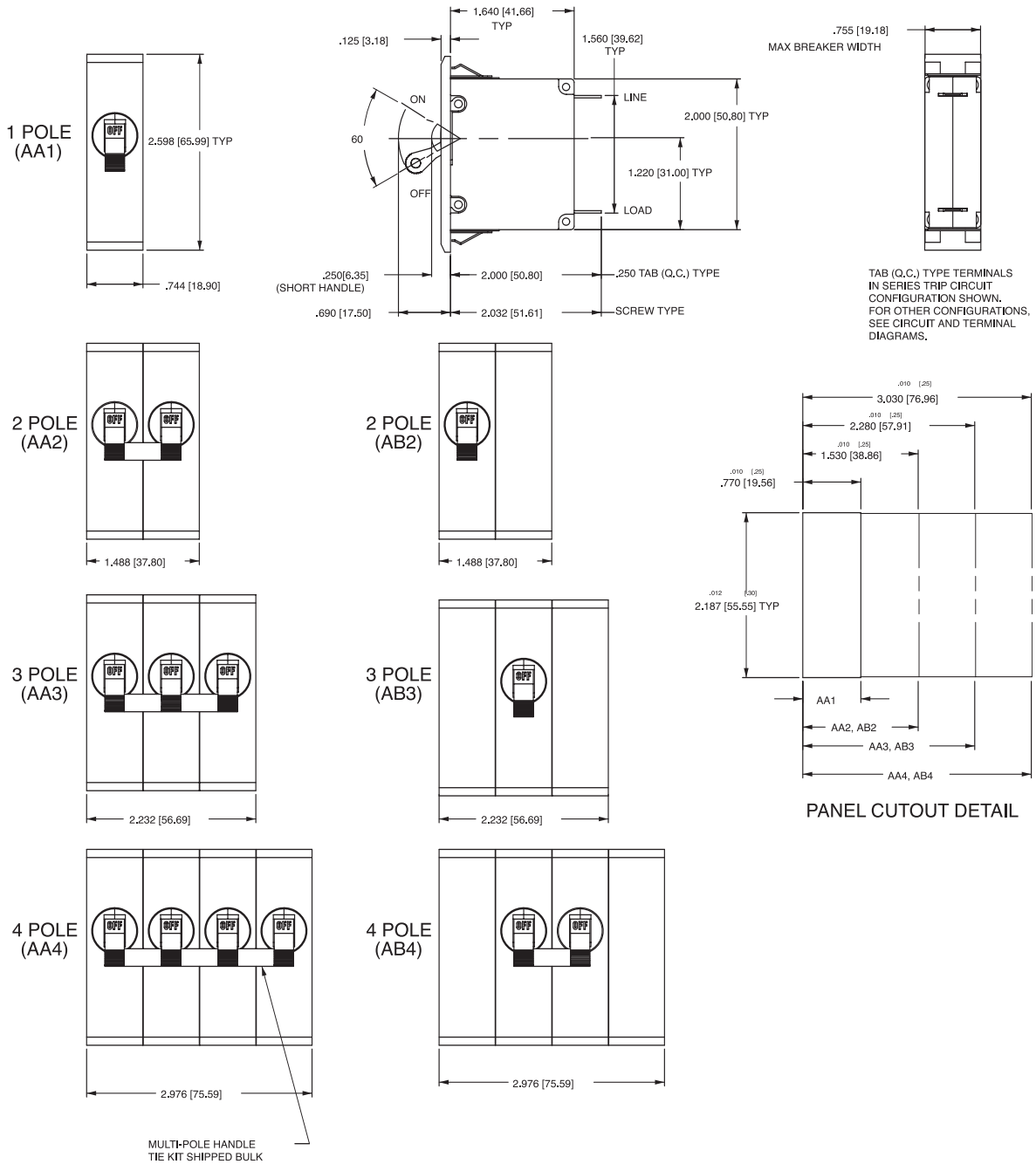

Notes:

- 1 All dimensions are in inches [millimeters].
- 2 Recommended panel thickness: .040 [1.02] to .100 [2.54].
- 3 Tolerance ±.020 [.51] unless otherwise specified.

A-Series Handle – Front Panel Snap-In Mounting Style 7

1 POLE (AA1)

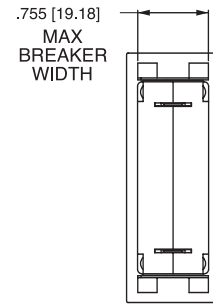
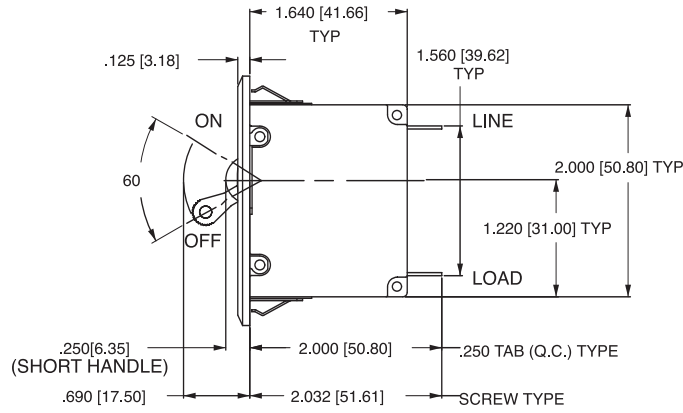
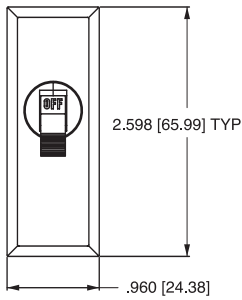

TAB (Q.C.) TYPE TERMINALS IN SERIES TRIP CIRCUIT CONFIGURATION SHOWN. FOR OTHER CONFIGURATIONS, SEE CIRCUIT AND TERMINAL DIAGRAMS.

2 POLE (AA2)

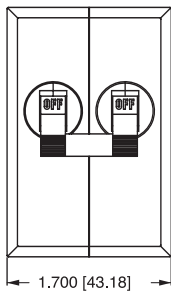

2 POLE (AB2)

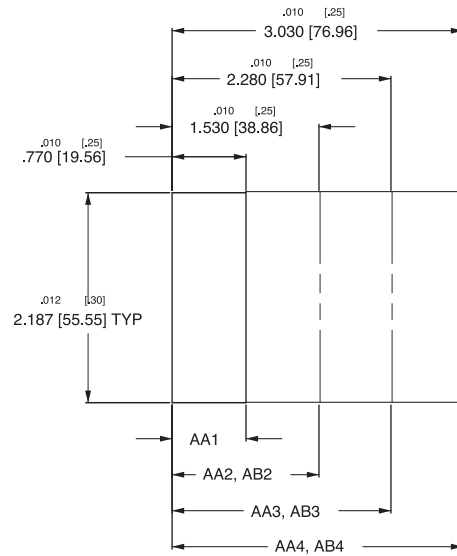
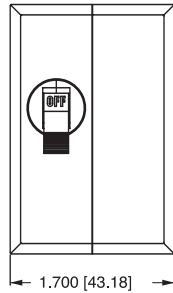

PANEL CUTOUT DETAIL

3 POLE (AA3)

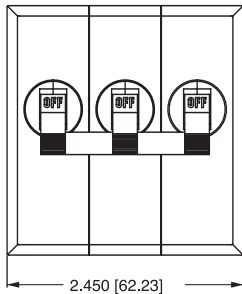

3 POLE (AB3)

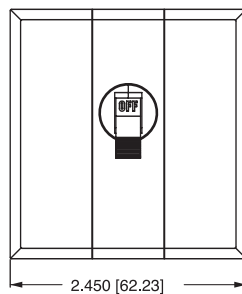

4 POLE (AA4)

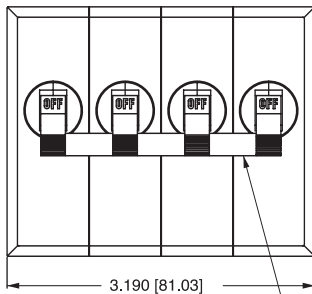

4 POLE (AB4)

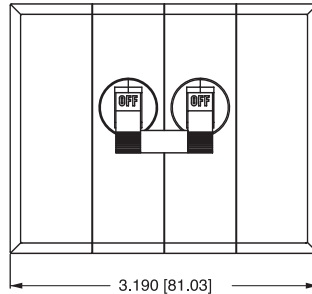

MULTI-POLE HANDLE TIE KIT SHIPPED BULK

- Notes:
- 1 All dimensions are in inches [millimeters].
 - 2 Recommended panel thickness: .040 [1.02] to .100 [2.54].
 - 3 Tolerance $\pm .020$ [.51] unless otherwise specified.

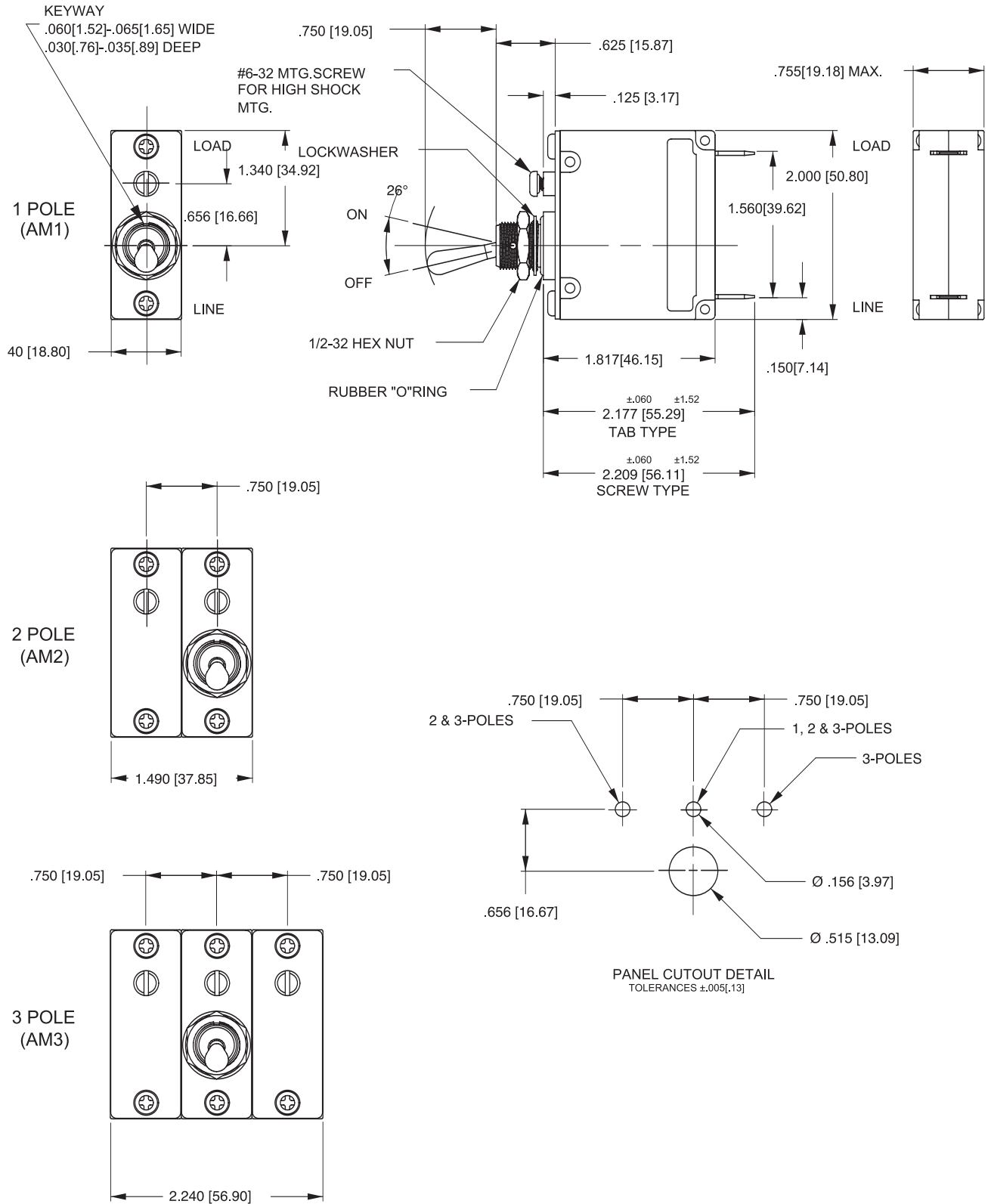

- Notes:
 1 All dimensions are in inches [millimeters].
 2 Tolerance ±.020 [.51] unless otherwise specified.

CIRCUIT BREAKER PROFILE	CIRCUIT SCHEMATIC		CIRCUIT CODE	AUX SWITCH CODE	CIRCUIT SCHEMATIC		CIRCUIT CODE	AUX SWITCH CODE
	ANSI	IEC			ANSI	IEC		
2 TERMINALS 	SWITCH ONLY (NO COIL) 	IEC 	A	0	SERIES TRIP 	IEC 	B C	0
5 TERMINALS 	SWITCH ONLY (NO COIL) WITH AUXILIARY SWITCH (4) 	IEC 	A	1 2 3 4	SERIES TRIP WITH AUXILIARY SWITCH (4) 	IEC 	B C	1 2 3 4
3 TERMINALS 	SHUNT TRIP 	IEC 	D E	0	DUAL COIL; SERIES TRIP CURRENT COIL, SHUNT TRIP VOLTAGE COIL 	IEC 	H	0
4 TERMINALS 	RELAY TRIP 	IEC 	F G	0	DUAL COIL; SERIES TRIP CURRENT COIL, RELAY TRIP VOLTAGE COIL 	IEC 	K	0

TERMINAL DESCRIPTION		DEPTH BEHIND PANEL
MAIN	TAB (Q.C.)	2.370 [60.20]
	SCREW TYPE	2.402 [61.01]
SHUNT, RELAY & DUAL COIL	TAB (Q.C.)	2.577 [65.46]
	SCREW #8-32 W/UPTURNED LUGS	2.734 [69.44]
AUX. SWITCH*	.093 TAB (Q.C.)	2.465 [62.61]
	.110 TAB (Q.C.)	2.559 [65.00]
	SOLDER TYPE	2.340 [59.44]

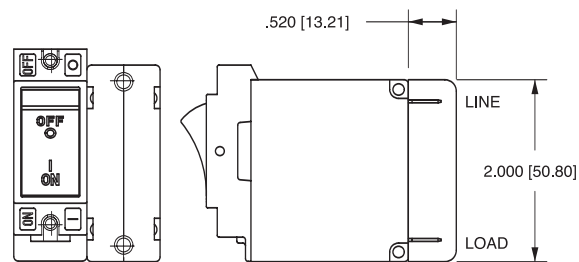

BARRIER FOR UL-RECOGNIZED MULTI-POLE BREAKERS

* AVAILABLE ON SERIES TRIP AND SWITCH ONLY CIRCUITS. WHEN CALLED FOR ON MULTI-POLE UNITS, ONLY ONE AUX. SWITCH IS NORMALLY SUPPLIED, AS VIEWED IN MULTI-POLE IDENTIFICATION SCHEME.

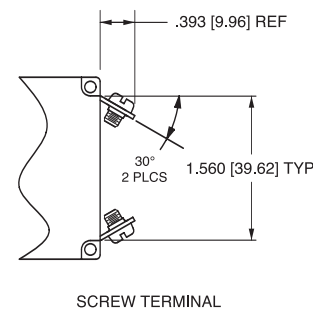
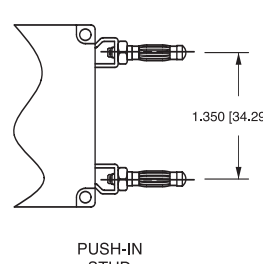
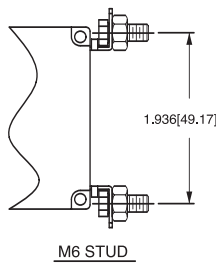
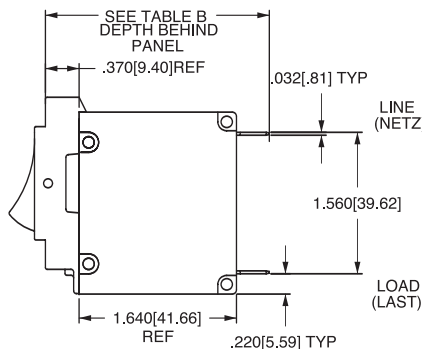

- Notes:
- All dimensions are in inches [millimeters].
 - Tolerance $\pm .020$ [.51] unless otherwise specified.
 - Schematic shown represents current trip circuit.
 - Circuits shown for >30 amps / VDE.

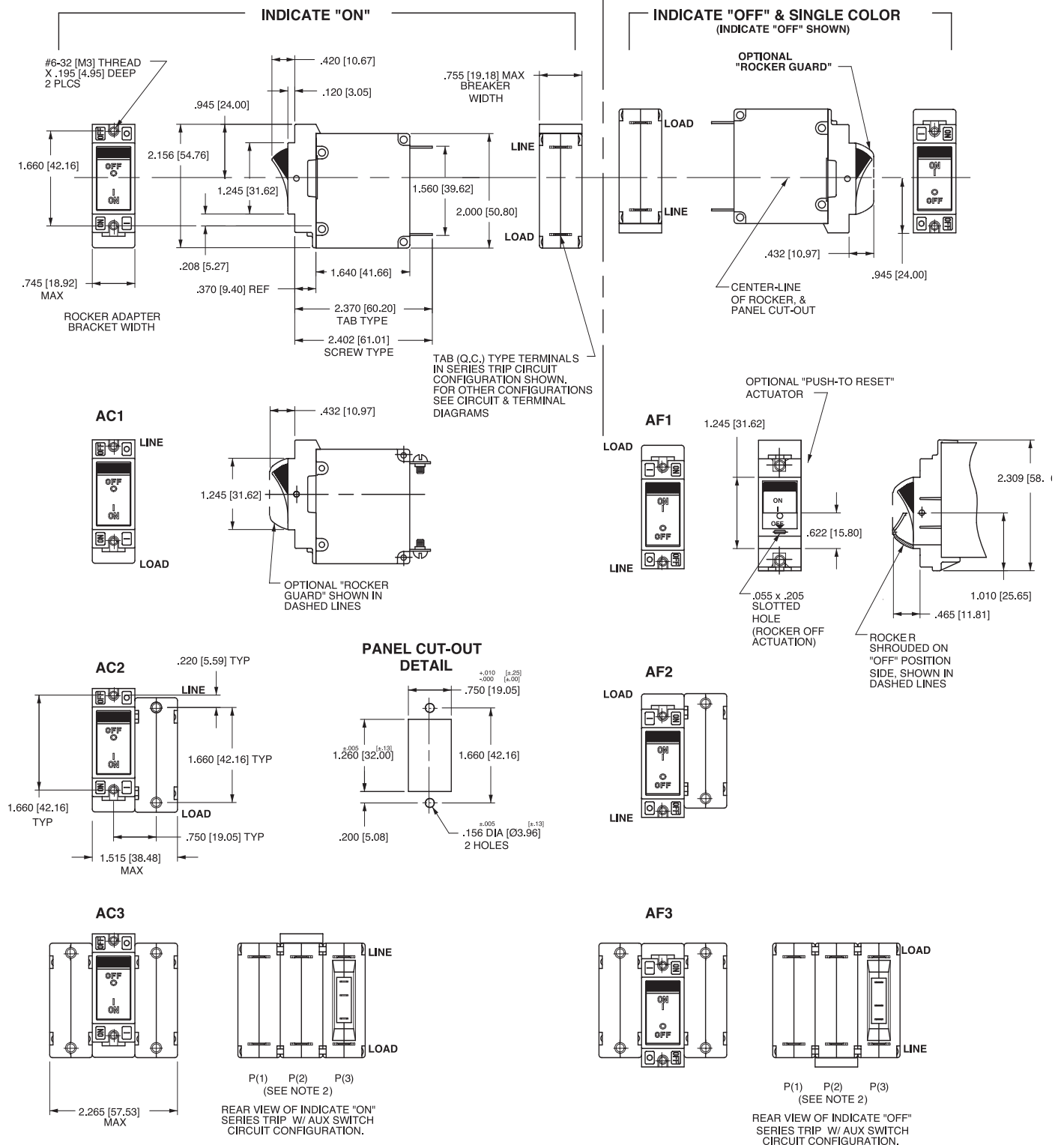

Notes:

- 1 Dimensions apply to all variations shown. Notice that circuit breaker line & load terminal orientation on indicate OFF is opposite of indicate ON.
- 2 For pole orientation with horizontal legend, rotate front view clockwise 90°.
- 3 All dimensions are in inches [millimeters].
- 4 Tolerance ± 0.20 [.51] unless otherwise specified.

INDICATE "ON"

FRONT PANEL SNAP-IN BRACKET, 0.96" [24.48 mm] wide bezel

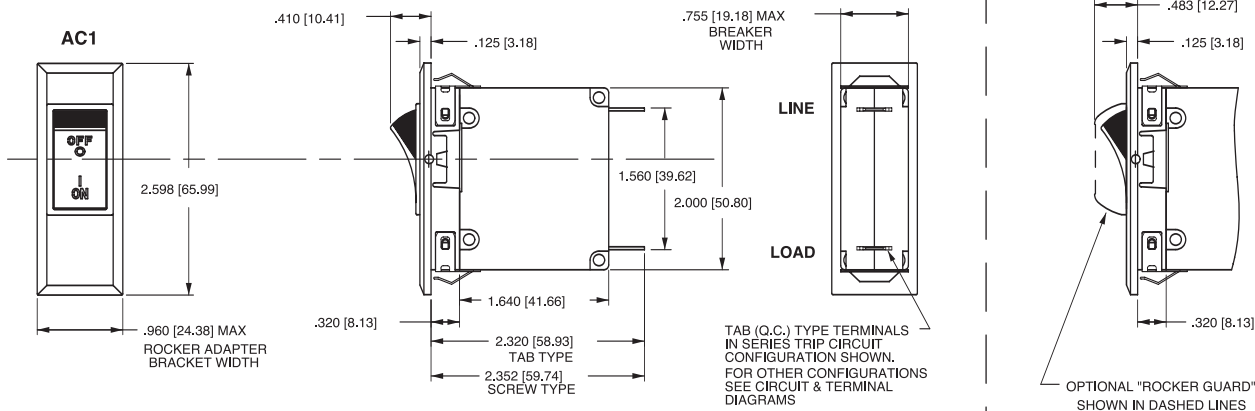

FRONT PANEL SNAP-IN BRACKET, 0.744" [18.90 mm] wide bezel

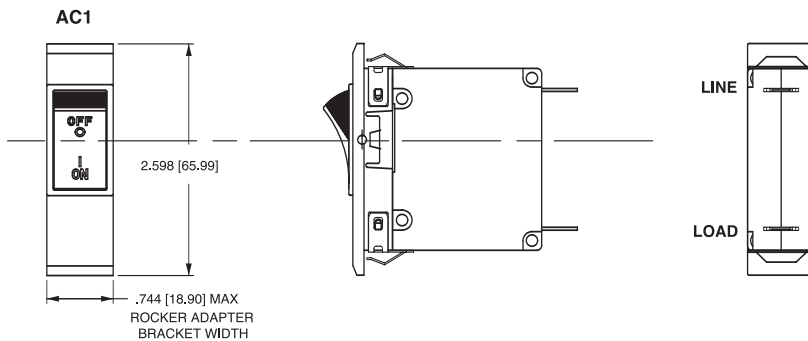

INDICATE "OFF"

FRONT PANEL SNAP-IN BRACKET, 0.96" [24.48 mm] wide bezel

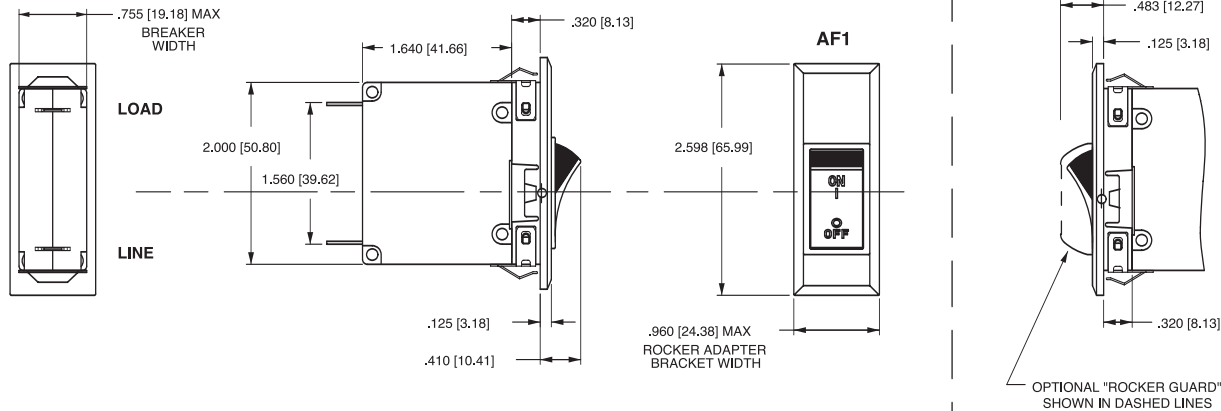

FRONT PANEL SNAP-IN BRACKET, 0.744" [18.90 mm] wide bezel

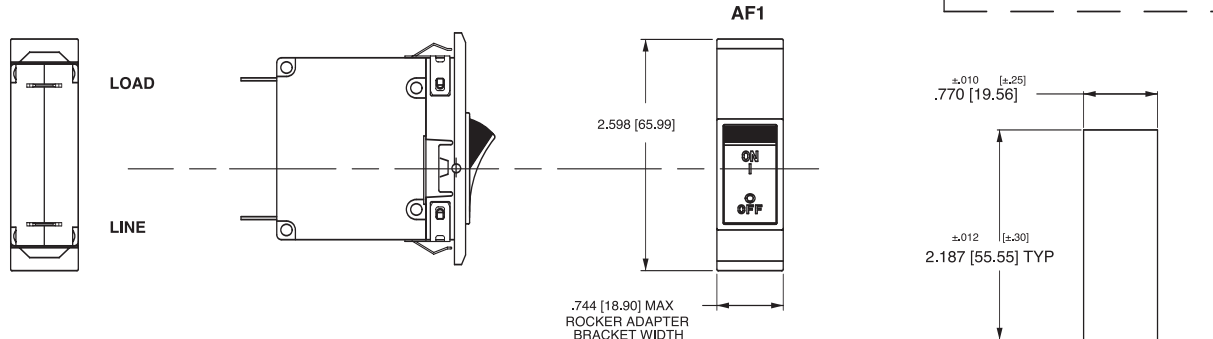

PANEL CUTOUT DETAIL

Notes:

- 1 Dimensions apply to all variations shown. Notice that circuit breaker line & load terminal
- 2 For pole orientation with horizontal legend, rotate front view clockwise 90°. Orientation on indicate "OFF" is opposite of indicate "ON"
- 3 Recommended panel thickness: .040 [1.02] to .100 [2.54]
- 4 All dimensions are in Inches [millimeters].
- 5 Tolerance ±.020 [1.51] unless otherwise specified.

INDICATE "OFF" & SINGLE COLOR
(INDICATE "OFF" SHOWN)

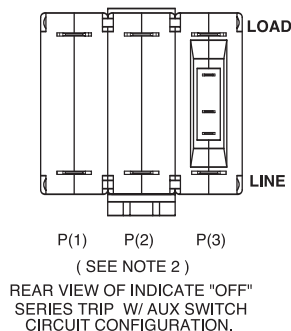
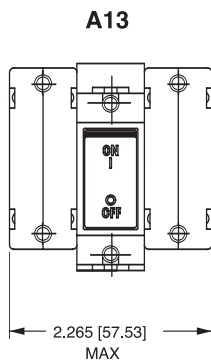
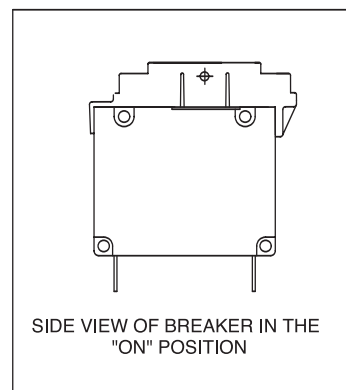
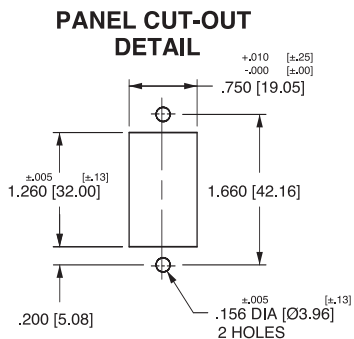
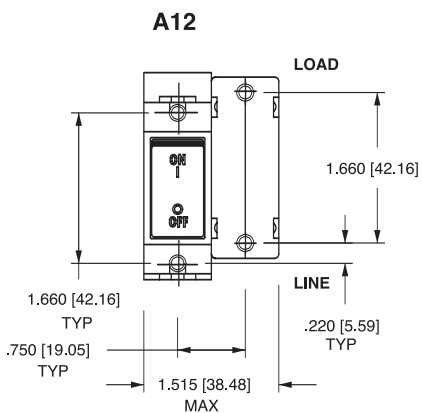
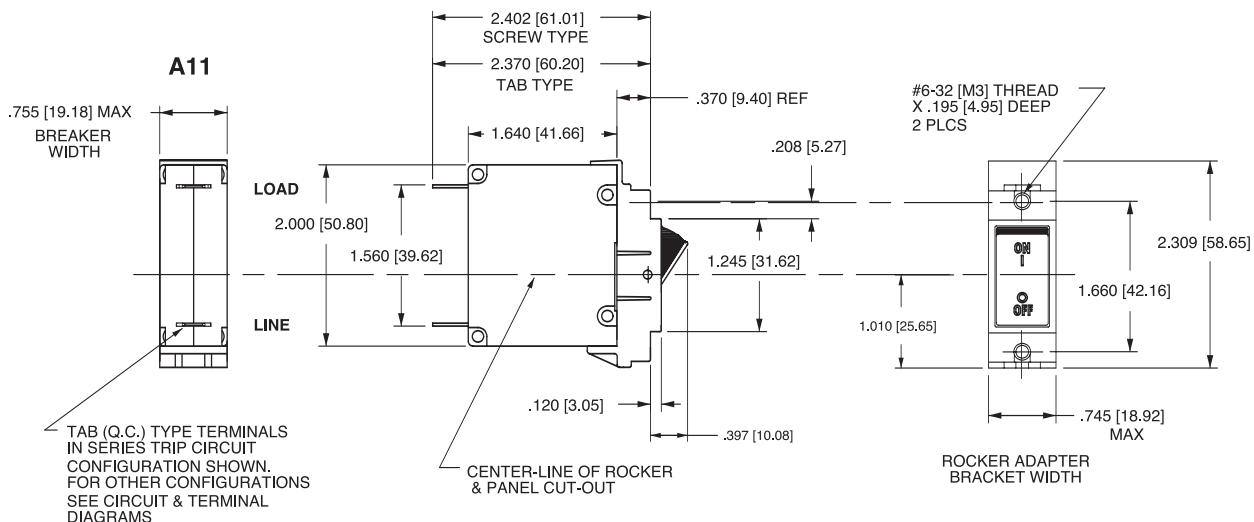

PUSH-TO-RESET ACTUATOR

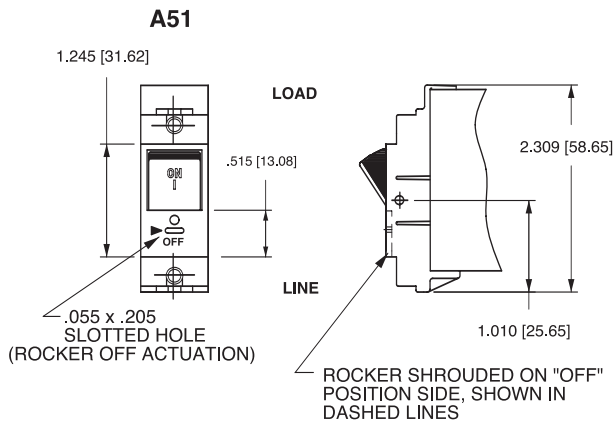

ACTUATOR SIDE VIEW (SURFACE CONTOURS)

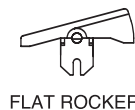

Notes:

- 1 All dimensions are in inches [millimeters].
- 2 For pole orientation with horizontal legend, rotate front view clockwise 90°.
- 3 Tolerance ± 0.20 [.51] unless otherwise specified.

A-SERIES ROCKER

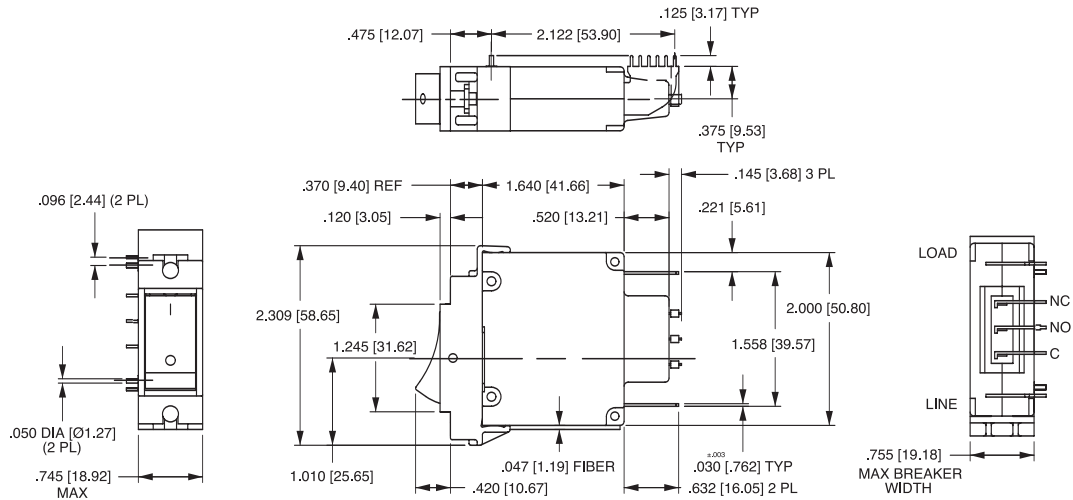

A-SERIES HANDLE

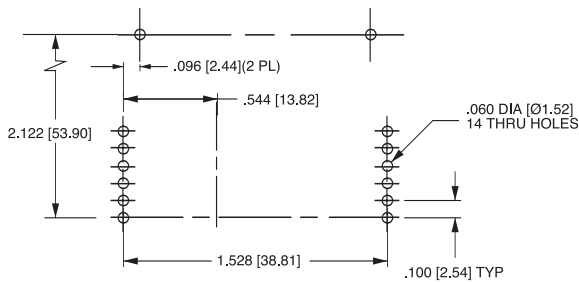
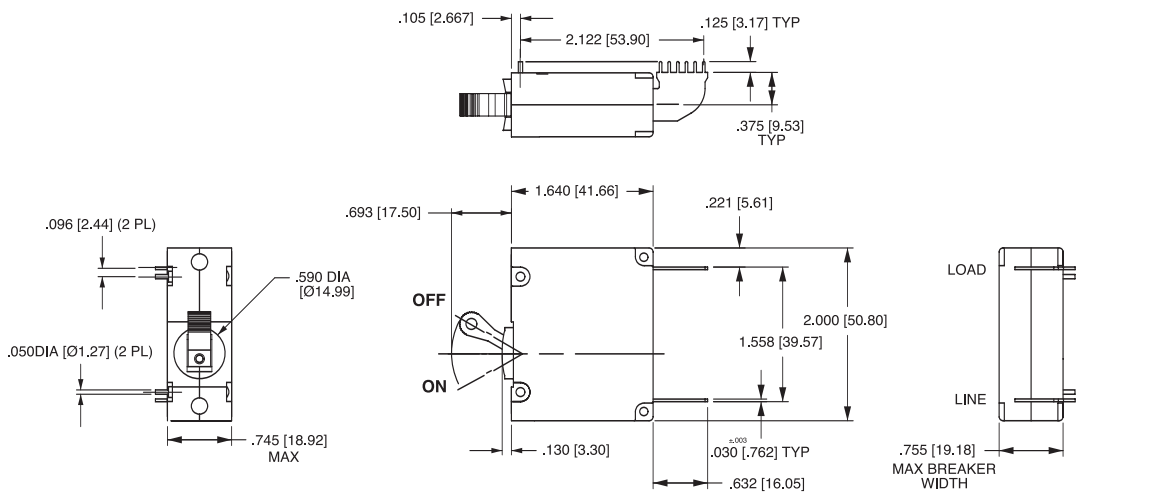

P.C. FOOT PRINT

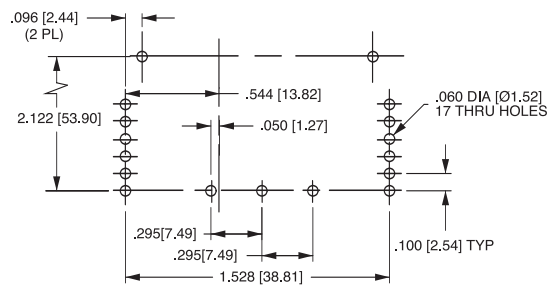

P.C. FOOT PRINT WITH AUX. SWITCH

- Notes:
- 1 Drawing illustrates A-Series with VDE certification.
 - 2 All dimensions are in inches [millimeters].
 - 3 Tolerance ± 0.20 [.51] unless otherwise specified.