



Features

- Shielded construction
- Inductance range: 1.0 to 1000 μ H
- Heating current up to 11 A
- Dimensions: 12 x 12 x 10 mm
- AEC-Q200 qualified
- RoHS compliant* and halogen free**

Applications

- Automotive systems:
 - Driver assistant
 - Entertainment
 - Information
 - Lighting
- DC/DC converters
- Power supplies

SRR1210A Series - Shielded Power Inductors

Electrical Specifications @ 25 °C

Bourns Part Number	Inductance @ 1 kHz / 0.25 V		Q Ref.	Q Test Freq. (MHz)	SRF (MHz) Typ.	DCR (Ω) Max.	I rms (A)	I sat (A)	***K-Factor
	L (μ H)	Tol. (%)							
SRR1210A-1R0Y	1.0	± 30	10	7.96	85	0.006	11.0	16.5	86
SRR1210A-1R8Y	1.8	± 30	10	7.96	56	0.075	10.2	13.2	67
SRR1210A-2R2Y	2.2	± 30	10	7.96	54	0.09	9.5	12.2	55
SRR1210A-3R3Y	3.3	± 30	15	7.96	44	0.01	9.0	10.5	46
SRR1210A-4R7Y	4.7	± 30	8	7.96	35	0.012	8.5	9.6	40
SRR1210A-5R6Y	5.6	± 30	12	7.96	28	0.0135	8.0	8.5	35
SRR1210A-6R8Y	6.8	± 30	12	7.96	20	0.015	7.85	8.3	32
SRR1210A-8R2Y	8.2	± 30	11	7.96	16	0.017	7.25	7.55	29
SRR1210A-100M	10	± 20	16	2.52	12	0.018	6.5	6.5	26
SRR1210A-120M	12	± 20	14	2.52	18	0.022	6.3	6.1	24
SRR1210A-150M	15	± 20	16	2.52	10.5	0.032	5.8	5.3	21
SRR1210A-180M	18	± 20	13	2.52	8	0.035	5.5	5.1	19
SRR1210A-220M	22	± 20	16	2.52	8	0.038	5.2	4.5	17
SRR1210A-270M	27	± 20	16	2.52	6.5	0.04	5.0	4.2	15
SRR1210A-330M	33	± 20	16	2.52	6.5	0.052	4.4	3.7	14
SRR1210A-390M	39	± 20	16	2.52	4.5	0.066	4.2	3.5	13
SRR1210A-470M	47	± 20	16	2.52	4.5	0.072	3.8	3.1	12
SRR1210A-560M	56	± 20	8	2.52	4	0.09	3.4	2.9	11
SRR1210A-680M	68	± 20	12	2.52	3.8	0.102	3.0	2.7	10
SRR1210A-820M	82	± 20	15	2.52	3.5	0.112	2.8	2.5	9
SRR1210A-101M	100	± 20	16	0.796	3	0.135	2.5	2.2	8
SRR1210A-121M	120	± 20	13	0.796	2.6	0.17	2.3	1.9	7
SRR1210A-151M	150	± 20	12	0.796	2.2	0.19	2.2	1.8	7
SRR1210A-181M	180	± 20	14	0.796	1.8	0.25	1.9	1.6	6
SRR1210A-221M	220	± 20	15	0.796	1.8	0.315	1.7	1.5	5
SRR1210A-271M	270	± 20	16	0.796	1.8	0.41	1.5	1.3	5
SRR1210A-331M	330	± 20	14	0.796	1.8	0.45	1.4	1.2	4
SRR1210A-391M	390	± 20	16	0.796	1.3	0.6	1.3	1.1	4
SRR1210A-471M	470	± 20	12	0.796	0.85	0.82	1.2	1.0	4
SRR1210A-561M	560	± 20	12	0.796	0.85	0.9	1.1	0.95	3
SRR1210A-681M	680	± 20	11	0.796	0.85	1.2	1.0	0.85	3
SRR1210A-821M	820	± 20	6	0.796	0.85	1.32	0.85	0.75	3
SRR1210A-102M	1000	± 20	22	0.796	0.85	1.65	0.75	0.7	3

***K-Factor: To calculate core flux density, B_p -p (gauss) = $K \times L(\mu H) \times \Delta I$ (peak-to-peak ripple current, A), determine core loss from *Core Loss vs. Flux Density* plot.

How to Order

SRR1210A - 100M

Model _____
Value Code (see table) _____

Electrical Schematic

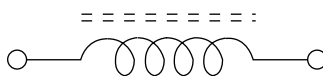

General Specifications

Operating Temperature -40 °C to +125 °C
(Temperature rise included)
Storage Temperature -40 °C to +125 °C
Resistance to Solder Heat +245°C for 10 sec.
Temperature Rise 40 °C typ. at rated I_{rms}
Inductance drop..... 20 % at I_{sat}

Materials

Core..... Ferrite
Wire..... Enameled copper
Terminal Finish..... Sn
Packaging..... 250 pcs. per reel

Product Dimensions

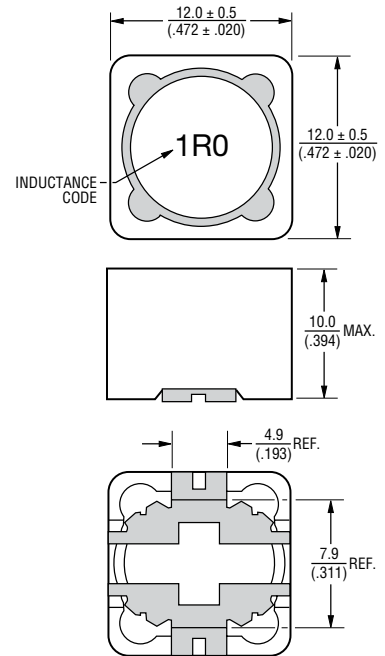

Recommended Layout

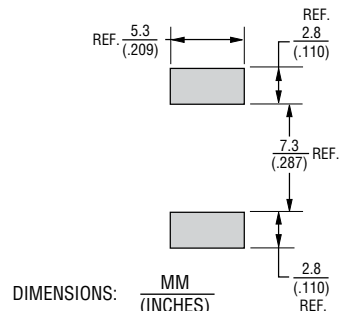

* RoHS Directive 2002/95/EC Jan. 27, 2003 including annex and RoHS Recast 2011/65/EU June 8, 2011.
** Bourns follows the prevailing definition of "halogen free" in the industry. Bourns considers a product to be "halogen free" if (a) the Bromine (Br) content is 900 ppm or less; (b) the Chlorine (Cl) content is 900 ppm or less; and (c) the total Bromine (Br) and Chlorine (Cl) content is 1500 ppm or less.
Specifications are subject to change without notice.
The device characteristics and parameters in this data sheet can and do vary in different applications and actual device performance may vary over time.
Users should verify actual device performance in their specific applications.

SRR1210A Series - Shielded Power Inductors

BOURNS®

Inductance vs. IDC

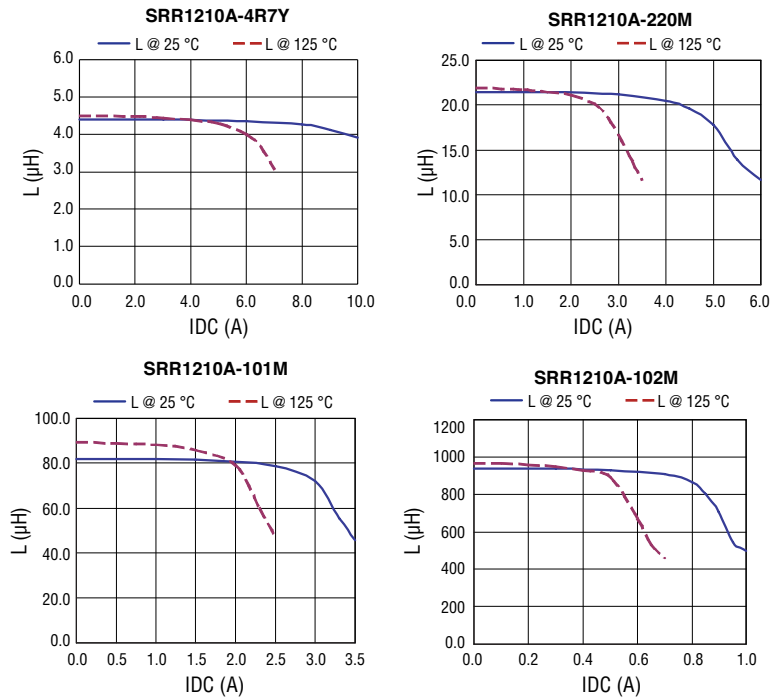

Temperature Rise vs. IDC

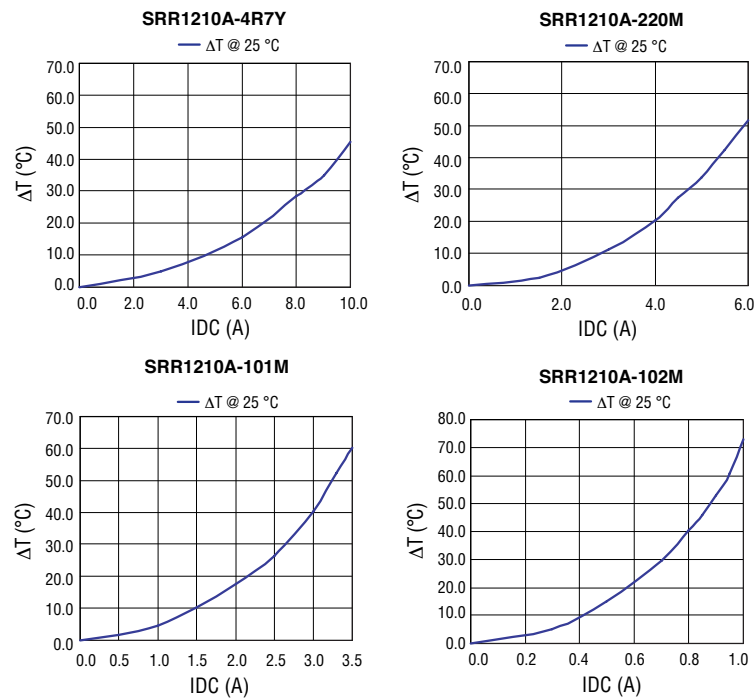

Specifications are subject to change without notice. The device characteristics and parameters in this data sheet can and do vary in different applications and actual device performance may vary over time. Users should verify actual device performance in their specific applications.

SRR1210A Series - Shielded Power Inductors

BOURNS®

Soldering Profile

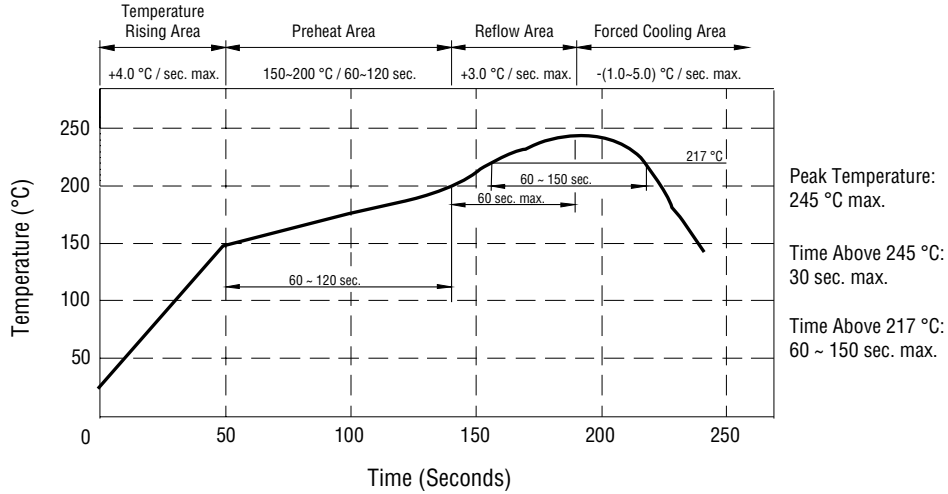

Core Loss vs. Flux Density

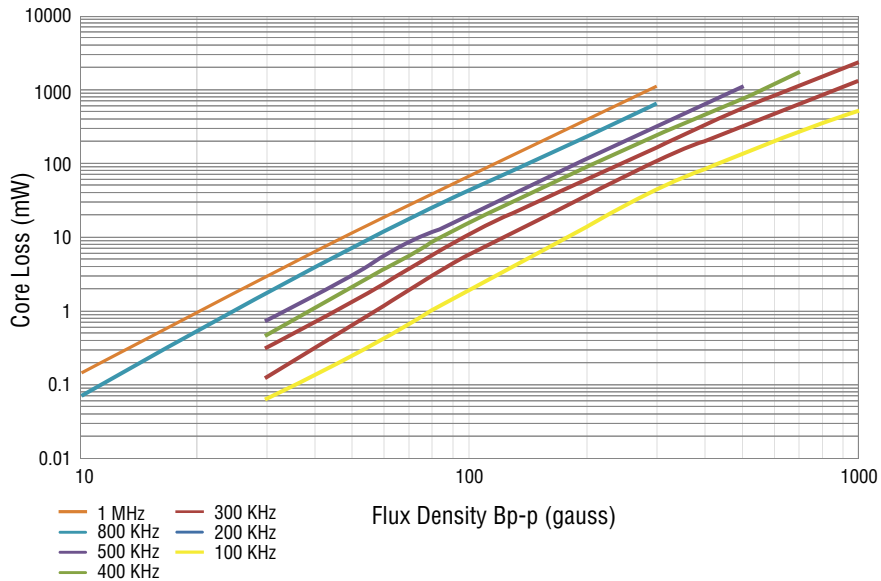

Specifications are subject to change without notice. The device characteristics and parameters in this data sheet can and do vary in different applications and actual device performance may vary over time. Users should verify actual device performance in their specific applications.

SRR1210A Series - Shielded Power Inductors

BOURNS®

Packaging Specifications

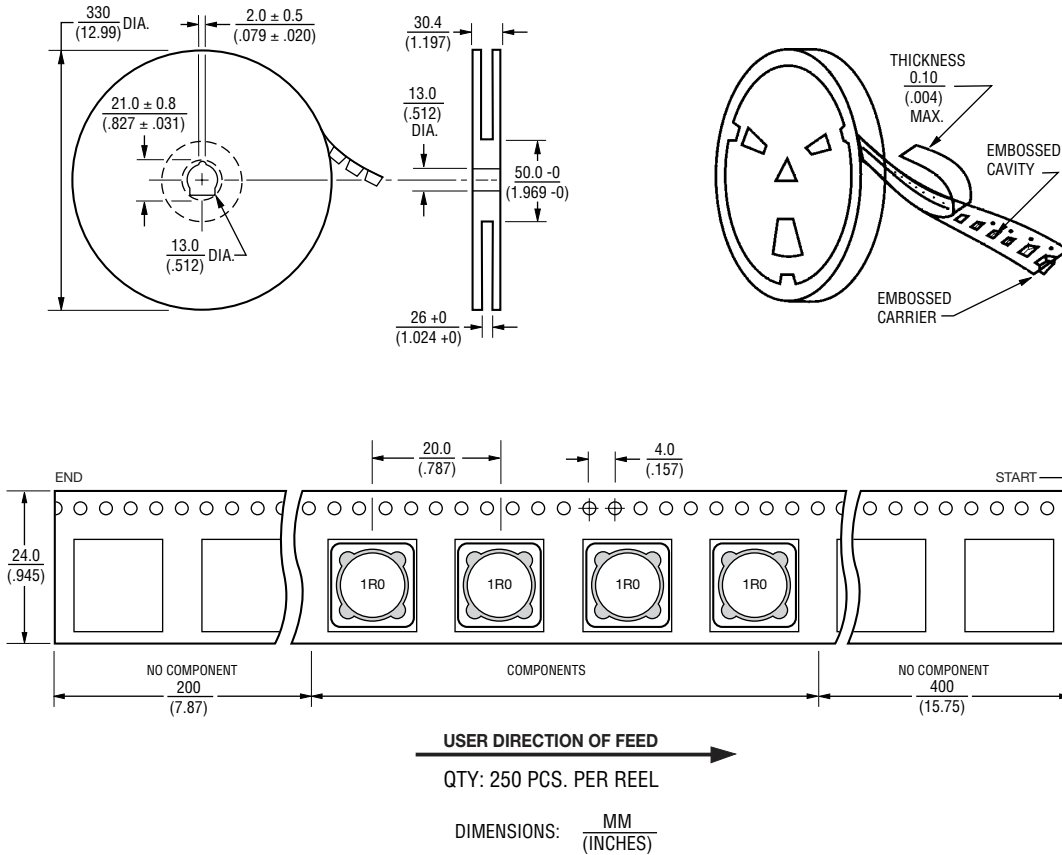

REV. 02/17

Specifications are subject to change without notice.
 The device characteristics and parameters in this data sheet can and do vary in different applications and actual device performance may vary over time.
 Users should verify actual device performance in their specific applications.