

8D - D38999 Stainless steel



MIL-DTL-38999 Serie III
Stainless steel

8D - D38999 Stainless steel



Connector part numbers

Basic Series	8D	0	-	11	K	35	P	N	**
Shell style:									
0: Square flange receptacle									
1: In line receptacle									
7: Jam nut receptacle									
5: Plug with RFI shielding.									
Type:									
-: Connectors with standard crimp contacts.									
L: Receptacle with long spill (male and female size #22D, #20).									
C: Receptacle with short spill (male and female #22D, #20, #16).									
S: Receptacle with specific spill (male et female #22D)									
W: Receptacle with male contacts #22D for wire wrap (3 wraps)									
T: Receptacle with male contacts #20 for wire wrap (2 wraps)									
Shell size: 09 - 11 - 13 - 15 - 17 - 19 - 21 - 23 - 25									
Plating:									
K: Passivated S: Nickel									
Contact layout: See page 8 to 11									
Contact type:									
P: Pin A: Connector supplied less pin contact or with specific contacts (Connector marking: A+ orientation)									
S: Socket B: Connector supplied less socket contact or with specific contacts (Connector marking: B+ orientation)									
Orientation: N, A, B, C, D & E (See page 58)									
Spécification:									
046: Tinned straight spills									
251: Connector provided with power contacts (layouts with contacts #8)									
022: Fuel tank									
L: For P or S contact type only, connectors delivered without contacts, connectors marking P or S plus orientation.									

MIL-DTL 38999 part numbers*

Basic Series	D38999	20	K	B	35	P	N	L
Shell style:								
20: Square flange receptacle								
24: Jam nut receptacle								
26: Plug with RFI shielding.								
Plating:								
K: Passivated								
S: Nickel								
Shell size: A - B - C - D - E - F - G - H - J								
Contact layout: See page 11 for layout according to MIL-DTL-38999								
Contact type:								
P: Pin A: Connector supplied less pin contact or with specific contacts (connector marking: A + orientation).								
S: Socket B: Connector supplied less socket contact or with specific contacts (connector marking: B + orientation).								
Orientation: N, A, B, C, D & E (see page 58)								
L: For P or S contact type only, connector delivered without contacts, connector marking P or S (without L)								

* **Note:** To place an order of MIL connectors delivered without MIL removable crimp contacts and keep P or S plus orientation marking, it must be specify clearly on the order (by adding a suffix L at the end of the P / N or specified in comment).

8D - D38999 Stainless steel



Dimensions

Receptacle type 0



Shell size	A Max.	B Max.	C Max.	D thread	E ± 0,30	F	G	H ± 0,20	J ± 0,20
09 (A)	20.90	10.60	2.50	M12 x 1-6g	23.80	18.26	15.09	3.25	5.49
11 (B)	20.90	10.60	2.50	M15 x 1-6g	26.20	20.62	18.26	3.25	4.93
13 (C)	20.90	10.60	2.50	M18 x 1-6g	28.60	23.01	20.62	3.25	4.93
15 (D)	20.90	10.60	2.50	M22 x 1-6g	31.00	24.61	23.01	3.25	4.93
17 (E)	20.90	10.60	2.50	M25 x 1-6g	33.30	26.97	24.61	3.25	4.93
19 (F)	20.90	10.60	2.50	M28 x 1-6g	36.50	29.36	26.97	3.25	4.93
21 (G)	20.10	11.40	3.20	M31 x 1-6g	39.70	31.75	29.36	3.25	4.93
23 (H)	20.10	11.40	3.20	M34 x 1-6g	42.90	34.93	31.75	3.91	6.15
25 (J)	20.10	11.40	3.20	M37 x 1-6g	46.00	38.10	34.93	3.91	6.15

Receptacle type 7

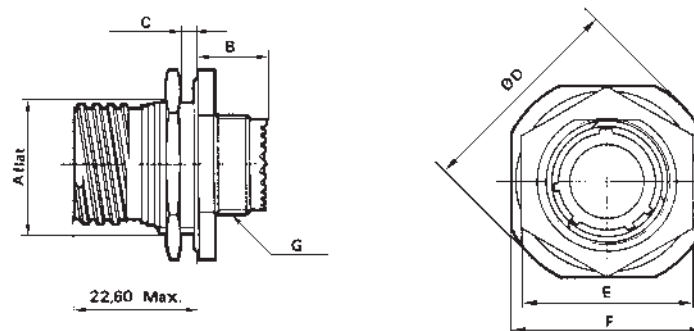

Shell size	A + 0.10 - 0.15	B Max.	C Max.	D Max.	E Max.	F ± 0.4	G thread
09 (A)	16.53	9.90	3.20	30.50	23.00	27.00	M12 x 1-6g
11 (B)	19.07	9.90	3.20	35.20	26.00	31.80	M15 x 1-6g
13 (C)	23.82	9.90	3.20	38.40	31.00	34.90	M18 x 1-6g
15 (D)	26.97	9.90	3.20	41.60	34.00	38.10	M22 x 1-6g
17 (E)	30.15	9.90	3.20	44.80	37.00	41.30	M25 x 1-6g
19 (F)	33.32	9.90	3.20	49.50	41.00	46.00	M28 x 1-6g
21 (G)	36.50	9.90	3.20	52.70	46.00	49.20	M31 x 1-6g
23 (H)	39.67	9.90	3.20	55.90	47.00	52.40	M34 x 1-6g
25 (J)	42.85	9.90	3.20	59.00	52.00	55.60	M37 x 1-6g

8D - D38999 Stainless steel



In line receptacle type 1



Shell size	D thread	Ø F
09 (A)	M12 x 1-6g	15.90
11 (B)	M15 x 1-6g	19.05
13 (C)	M18 x 1-6g	22.25
15 (D)	M22 x 1-6g	25.40
17 (E)	M25 x 1-6g	30.15
19 (F)	M28 x 1-6g	31.75
21 (G)	M31 x 1-6g	34.75
23 (H)	M34 x 1-6g	37.10
25 (J)	M37 x 1-6g	41.30

Plug type 5



Shell size	A Max.	B thread	C Max.
09 (A)	31.00	M12 x 1-6g	21.80
11 (B)	31.00	M15 x 1-6g	25.00
13 (C)	31.00	M18 x 1-6g	29.40
15 (D)	31.00	M22 x 1-6g	32.50
17 (E)	31.00	M25 x 1-6g	35.70
19 (F)	31.00	M28 x 1-6g	38.50
21 (G)	31.00	M31 x 1-6g	41.70
23 (H)	31.00	M34 x 1-6g	44.90
25 (J)	31.00	M37 x 1-6g	48.00

Maximum coupling torque on panel for jam nut receptacle (type 7)

Shell	09 (A)	11 (B)	13 (C)	15 (D)	17 (E)	19 (F)	21 (G)	23 (H)	25 (J)
Coupling torque (N.m)	6	8	10	13	20	23	25	26	28

Mated connectors dimensions

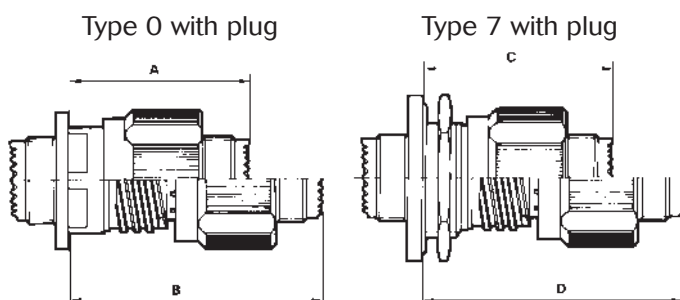

Shell size	A Max.	B Max.	C Max.	D Max.
09 (A)	37.00	52.30	38.30	53.60
11 (B)	37.00	52.30	38.30	53.60
13 (C)	37.00	52.30	38.50	53.80
15 (D)	37.00	52.30	38.50	53.80
17 (E)	37.00	52.30	38.50	53.80
19 (F)	37.00	52.30	38.50	53.80
21 (G)	36.00	51.30	38.50	53.80
23 (H)	36.00	51.30	38.50	53.80
25 (J)	36.00	51.30	38.50	53.80

Dimensions in millimeters

8D - D38999 Stainless steel



Receptacle with straight spill contacts

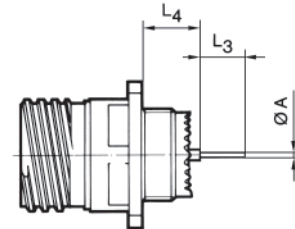
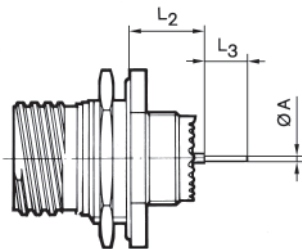

		Shell size			09 (A)	11 (B)	13 (C)	15 (D)	17 (E)	19 (F)	21 (G)	23 (H)	25 (J)
		Contact size	Contact type	Spill type									
A		# 22D	M & F	L & C					0,70				
		# 22D	M & F	S					0.50				
		# 20	M & F	C					0.70				
		# 16	M & F	C					1.15				
L2	Min.	# 22D	M	L & C	10.52					10.34			
	Max.	# 22D	M	L & C	11.46					11.28			
	Min.	# 22D	F	L & C	10.19					10.01			
	Max.	# 22D	F	L & C	11.46					11.28			
	Min.	# 22D	M	S	10.69					10.51			
	Max.	# 22D	M	S	11.63					11.45			
	Min.	# 22D	F	S	10.36					10.18			
	Max.	# 22D	F	S	11.63					11.45			
	Min.	# 20	M	C	10.69					10.51			
	Max.	# 20	M	C	11.63					11.45			
	Min.	# 20	F	C	10.69					10.51			
	Max.	# 20	F	C	11.63					11.45			
	Min.	# 16	M	C	10.69					10.51			
	Max.	# 16	M	C	11.63					11.45			
Min.	# 16	F	C	10.69					10.51				
Max.	# 16	F	C	11.63					11.45				
L3		# 22D	M & F	L					8.50				
		# 22D	M & F	C					4.00				
		# 22D	M & F	S					5.10				
		# 20	M & F	C					5.10				
		# 16	M & F	C					5.10				
L4	Min.	# 22D	M	L & C			9.48					9.59	
	Max.	# 22D	M	L & C			10.58					10.69	
	Min.	# 22D	F	L & C			9.15					9.26	
	Max.	# 22D	F	L & C			10.58					10.69	
	Min.	# 22D	M	S			9.65					9.76	
	Max.	# 22D	M	S			10.75					10.86	
	Min.	# 22D	F	S			9.15					9.26	
	Max.	# 22D	F	S			10.75					10.86	
	Min.	# 20	M	C			9.65					9.76	
	Max.	# 20	M	C			10.75					10.86	
	Min.	# 20	F	C			9.65					9.76	
	Max.	# 20	F	C			10.75					10.86	
	Min.	# 16	M	C			9.65					9.76	
	Max.	# 16	M	C			10.75					10.86	
Min.	# 16	F	C			9.65					9.76		
Max.	# 16	F	C			10.75					10.86		

M : Male contact F: Female contact L: Long spill C : Short spill S: Specific spill

Dimensions in millimeters

8D - D38999 Stainless steel



Connectors weight

	With contacts						Without contact					
	Plug (type 5)		Receptacle (type 0)		Receptacle (type 7)		Plug (type 5)		Receptacle (type 0)		Receptacle (type 7)	
	Male	Female	Male	Female	Male	Female	Male	Female	Male	Female	Male	Female
09-35	30.63	32.21	23.93	25.51	33.93	35.51	30.21	30.71	23.51	24.01	33.51	34.01
09-98	30.63	31.93	23.93	25.23	33.93	35.23	30.21	30.73	23.51	24.03	33.51	34.03
11-01	38.13	41.07	29.53	32.47	42.43	45.37	37.47	39.47	28.87	30.87	41.77	43.77
11-02	37.76	40.30	29.36	30.12	46.98	49.52	37.14	38.74	28.56	30.16	46.36	47.96
11-04	37.95	41.01	29.35	32.41	42.25	45.31	37.39	39.41	28.79	30.81	41.69	43.71
11-05	37.98	41.19	29.38	32.59	42.04	45.49	37.28	39.19	28.68	30.59	41.58	43.49
11-22	37.48	39.54	28.90	130.86	46.70	48.76	37.34	39.04	28.76	30.36	46.56	48.26
11-35	37.88	41.35	29.28	32.75	41.94	45.65	36.97	38.10	28.37	29.50	41.27	42.40
11-80	38.12	44.84	29.73	36.26	47.78	54.06	34.86	37.84	26.45	29.26	44.51	47.06
11-98	37.85	40.61	29.25	32.01	42.15	44.91	37.01	38.21	28.41	29.61	41.31	42.51
11-99	38.02	41.24	29.44	32.66	47.24	50.46	37.04	38.44	28.46	29.86	46.26	47.66
13-04	53.34	57.12	37.94	41.72	56.24	60.02	52.10	54.00	36.70	38.60	55.00	56.90
13-08	53.72	58.90	38.32	43.50	56.62	61.80	52.60	55.70	37.20	40.30	55.50	58.60
13-26	54.09	59.74	38.69	44.34	56.99	62.64	52.35	55.04	36.95	39.64	55.25	57.94
13-35	53.52	59.29	38.12	43.89	56.42	62.19	51.98	53.79	36.58	38.39	54.88	56.69
13-98	53.38	58.00	37.98	42.60	56.28	60.90	51.98	54.00	36.58	38.60	54.88	56.90
15-05	64.49	69.83	45.69	51.03	67.59	72.93	62.94	65.93	44.14	47.13	66.04	69.03
15-15	65.29	72.45	46.49	53.65	68.39	75.55	63.02	66.07	44.22	47.27	66.12	69.17
15-18	65.50	74.38	46.70	55.58	68.60	77.48	62.98	67.18	44.18	48.38	66.08	70.28
15-19	65.03	72.76	46.23	53.96	68.13	75.86	62.37	65.16	43.57	46.36	65.47	68.26
15-35	65.13	74.37	46.33	55.57	68.23	77.47	62.54	65.12	43.74	46.32	65.64	68.22
15-97	64.96	72.01	46.16	53.21	68.06	75.11	62.60	65.69	43.80	46.89	65.70	68.79
17-02	77.80	92.64	72.89	87.73	104.09	118.95	74.53	86.09	69.62	81.18	100.82	112.38
17-06	69.07	78.67	64.17	73.77	87.27	96.87	65.11	69.07	60.21	64.17	83.31	87.27
17-08	68.06	76.79	63.16	71.89	86.26	94.99	65.58	70.55	60.68	65.65	83.78	88.75
17-26	68.64	79.43	63.74	74.53	86.84	97.63	65.00	69.03	60.10	64.13	83.20	87.23
17-35	68.88	82.43	63.98	77.53	87.08	100.63	65.03	68.68	60.13	63.78	83.23	86.88
17-75	74.48	85.77	69.58	80.87	92.68	103.97	65.48	71.77	60.58	66.87	83.68	89.97
17-99	68.69	79.25	63.79	74.35	86.89	97.45	65.13	69.29	60.23	64.39	83.33	87.49
19-11	87.04	100.63	67.69	81.28	97.59	111.18	83.63	92.05	64.28	73.45	94.18	103.35
19-32	86.25	99.65	66.90	80.30	96.80	110.20	81.77	86.85	62.42	67.50	92.32	97.40
19-35	86.56	103.01	67.21	83.66	97.11	113.56	81.94	86.51	62.59	67.16	92.49	97.06
21-11	99.71	119.55	81.81	101.65	111.81	131.65	92.45	101.95	74.55	84.05	104.55	114.05
21-16	96.81	112.09	78.91	94.19	108.91	124.19	91.85	99.61	73.95	81.71	103.95	111.71
21-35	97.09	117.75	79.19	99.85	109.19	129.85	91.56	98.00	73.66	80.10	103.66	110.10
21-39	98.47	118.80	80.57	100.90	110.57	130.90	92.67	102.44	74.77	84.54	104.77	114.54
21-41	97.01	114.38	79.11	126.48	109.11	126.48	91.27	97.98	73.37	80.08	103.37	80.08
21-48	103.84	123.82	85.93	105.91	126.02	146.02	90.72	97.62	72.81	79.71	112.92	119.82
21-75	108.72	125.62	90.81	107.71	130.92	147.82	90.72	97.62	72.81	79.71	112.92	119.82
23-21	108.81	132.06	90.61	113.86	122.81	146.06	102.30	115.68	84.10	97.48	116.30	129.68
23-35	107.17	133.32	88.97	115.12	121.17	147.32	100.17	108.32	81.97	90.12	114.17	122.32
23-53	107.23	129.42	89.03	111.22	121.23	143.42	99.81	108.22	81.61	90.02	113.81	122.22
23-55	107.98	131.05	89.78	112.85	121.98	145.05	100.28	109.05	82.08	90.85	114.28	123.05
25-07	133.3	157.7	115.5	172.25	160.06	172.25	108.51	119.45	90.71	101.65	135.27	101.65
25-11	132.31	152.31	114.51	134.51	159.71	179.07	111.51	124.51	93.71	106.71	138.91	151.27
25-19	122.14	154.15	104.34	136.35	136.74	168.75	109.60	123.75	91.80	105.95	124.20	138.35
25-24	121.64	153.00	103.84	135.20	136.24	167.60	110.00	124.44	92.20	106.64	124.60	139.04
25-29	119.96	148.93	102.16	131.13	134.56	163.53	110.97	126.31	93.17	108.51	125.57	140.91
25-35	117.75	150.58	99.95	132.78	132.35	165.18	108.79	118.58	90.99	100.78	123.39	133.18
25-37	119.98	148.26	102.18	162.67	146.74	162.67	108.51	119.40	90.71	101.60	135.27	101.60
25-44	140.35	164.98	122.55	179.58	167.11	179.71	106.81	117.08	89.01	99.28	133.57	99.41
25-43	120.00	150.68	102.20	132.88	134.60	165.28	110.58	125.88	92.78	108.08	125.18	140.48
25-46	122.30	146.14	104.50	128.34	136.90	160.74	107.66	117.82	89.86	100.02	122.26	132.42
25-61	117.05	143.80	99.25	126.00	131.65	158.40	108.51	119.40	90.71	101.60	123.11	155.51
25-08	143.38	175.21	125.58	157.41	157.98	189.81	107.38	119.21	89.58	101.41	121.98	133.81
25-20	128.40	158.62	110.60	140.82	143.00	173.22	106.83	117.08	89.03	99.28	121.43	131.68
25-04	120.80	150.65	103.00	132.85	135.40	165.25	111.60	125.21	93.80	107.41	126.20	139.81

Weight in gram