

SERIES 34B
Sealed Miniature Toggle Switches

FEATURES

- Save Space and Weight
- SPDT, DPDT, and 3PDT Circuitry
- Choice of Actuators, Bushings and Terminations
- Sealed per IP67



MODELS In inches (and millimeters)

SPDT

Model No.	Switching Position		
	↙	↘	↗
WSP1	ON	NONE	ON
WSP2	ON	NONE	(ON)
WSP3	ON	OFF	ON
WSP4	(ON)	OFF	(ON)
WSP5	ON	OFF	(ON)
Term. Comm.	2-3	OPEN	2-1

()=MOMENTARY

SCHEMATIC $\overset{02COMM.}{\bullet} \bullet \bullet$

DPDT

Model No.	Switching Position		
	↙	↘	↗
WDP1	ON	NONE	ON
WDP2	ON	NONE	(ON)
WDP3	ON	OFF	ON
WDP4	(ON)	OFF	(ON)
WDP5	ON	OFF	(ON)
Term. Comm.	2-3 5-6	OPEN	2-1 5-4

()=MOMENTARY

SCHEMATIC $\overset{02COMM.}{\bullet} \bullet \bullet \overset{05COMM.}{\bullet} \bullet \bullet$

3PDT

Model No.	Switching Position		
	↙	↘	↗
W3P1	ON	NONE	ON
W3P2	ON	NONE	(ON)
W3P3	ON	OFF	ON
W3P4	(ON)	OFF	(ON)
W3P5	ON	OFF	(ON)
Term. Comm.	2-3 5-6	OPEN	2-1 5-4

()=MOMENTARY

SCHEMATIC $\overset{02COMM.}{\bullet} \bullet \bullet \overset{05COMM.}{\bullet} \bullet \bullet \overset{08COMM.}{\bullet} \bullet \bullet$

Toggle Switches

ACTUATOR OPTIONS In inches (and millimeters)



BUSHING OPTIONS In inches (and millimeters)



TERMINATION OPTIONS In inches (and millimeters)

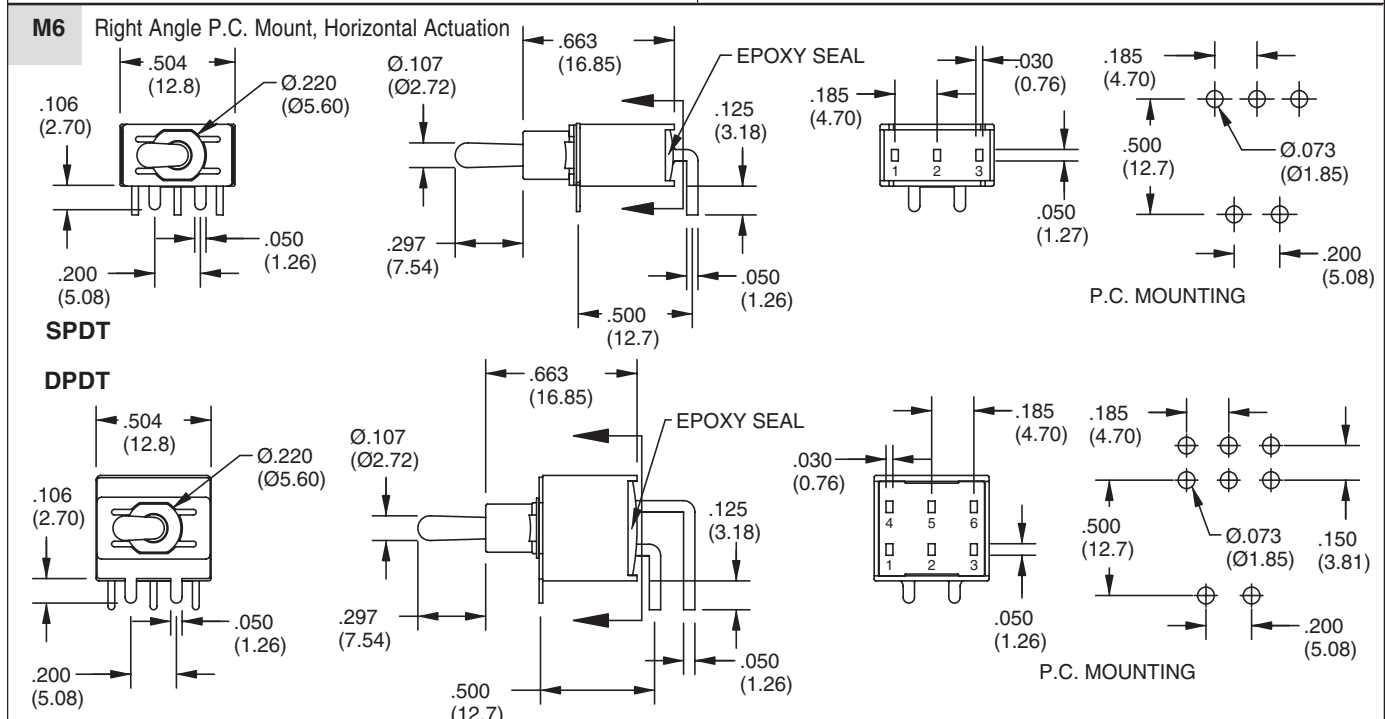
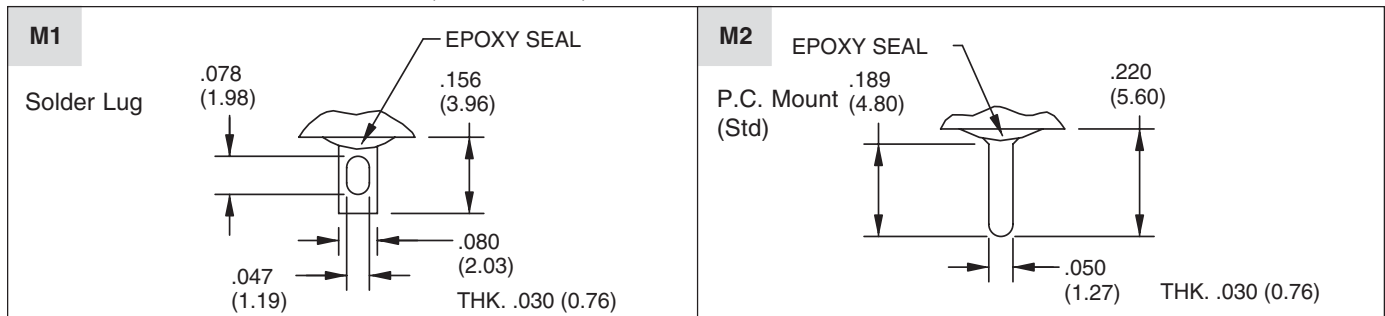

TERMINATION OPTIONS In inches (and millimeters)

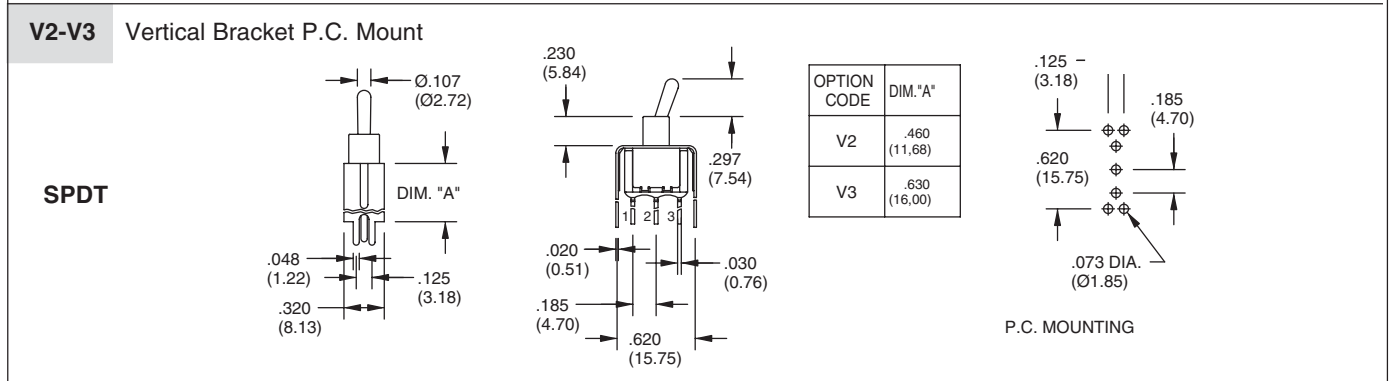
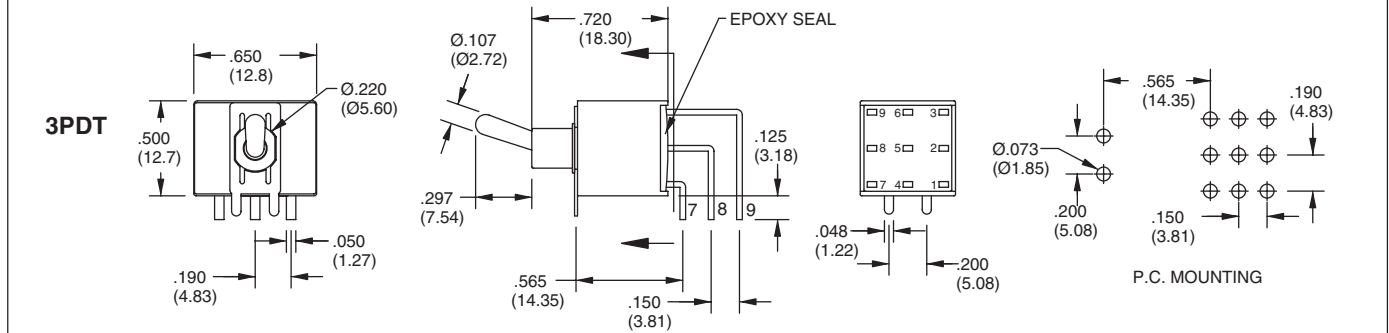
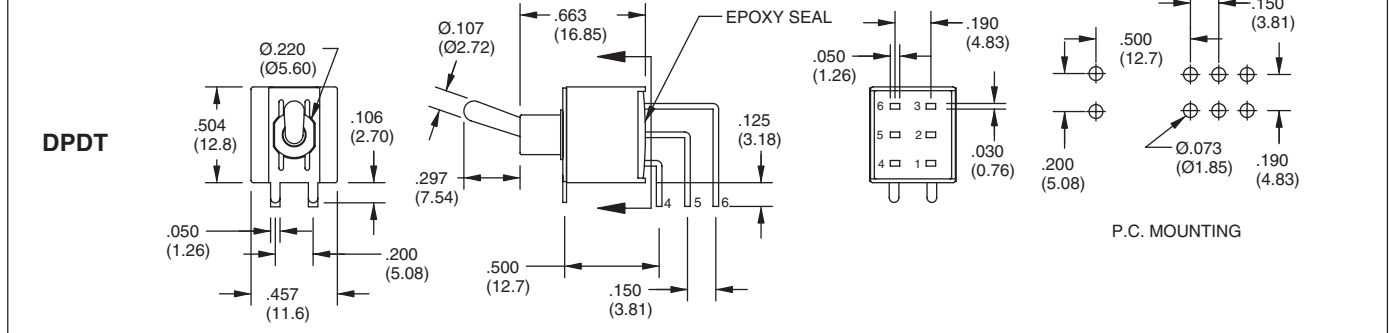
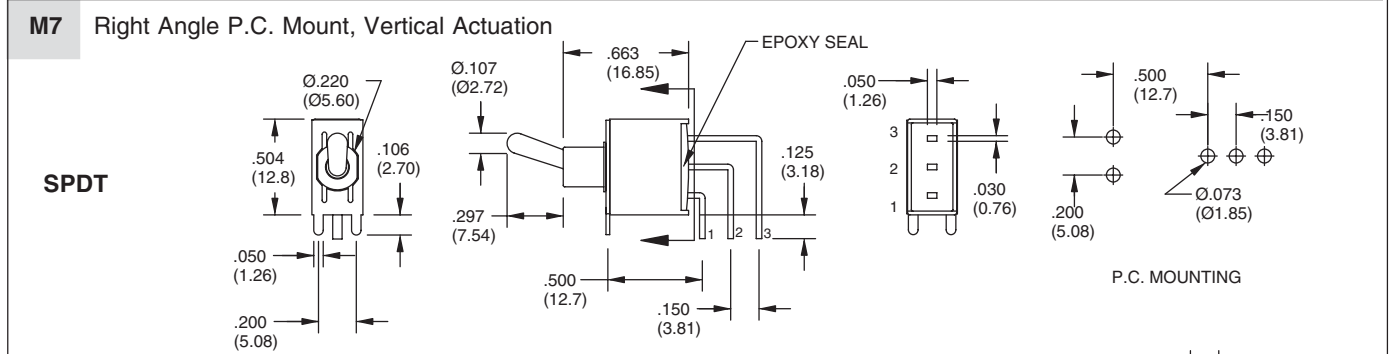
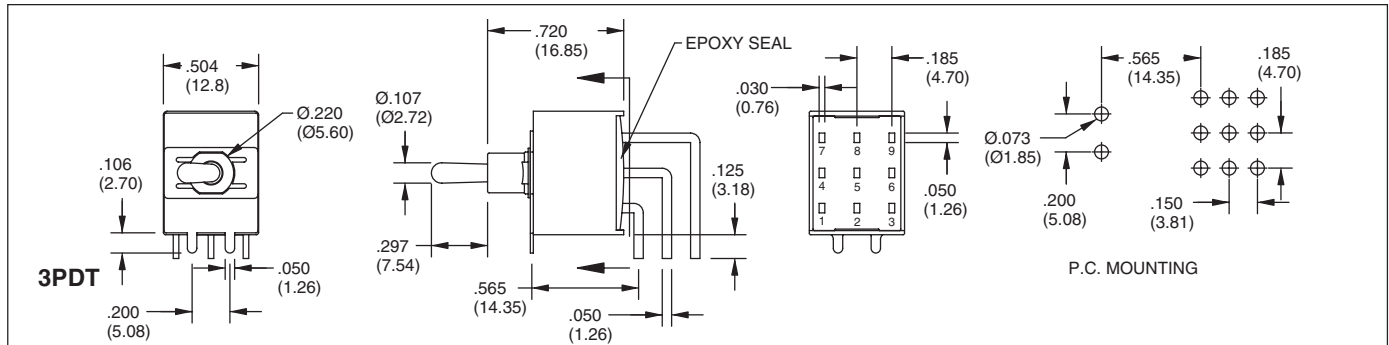

Toggle Switches

TERMINATION OPTIONS In inches (and millimeters)

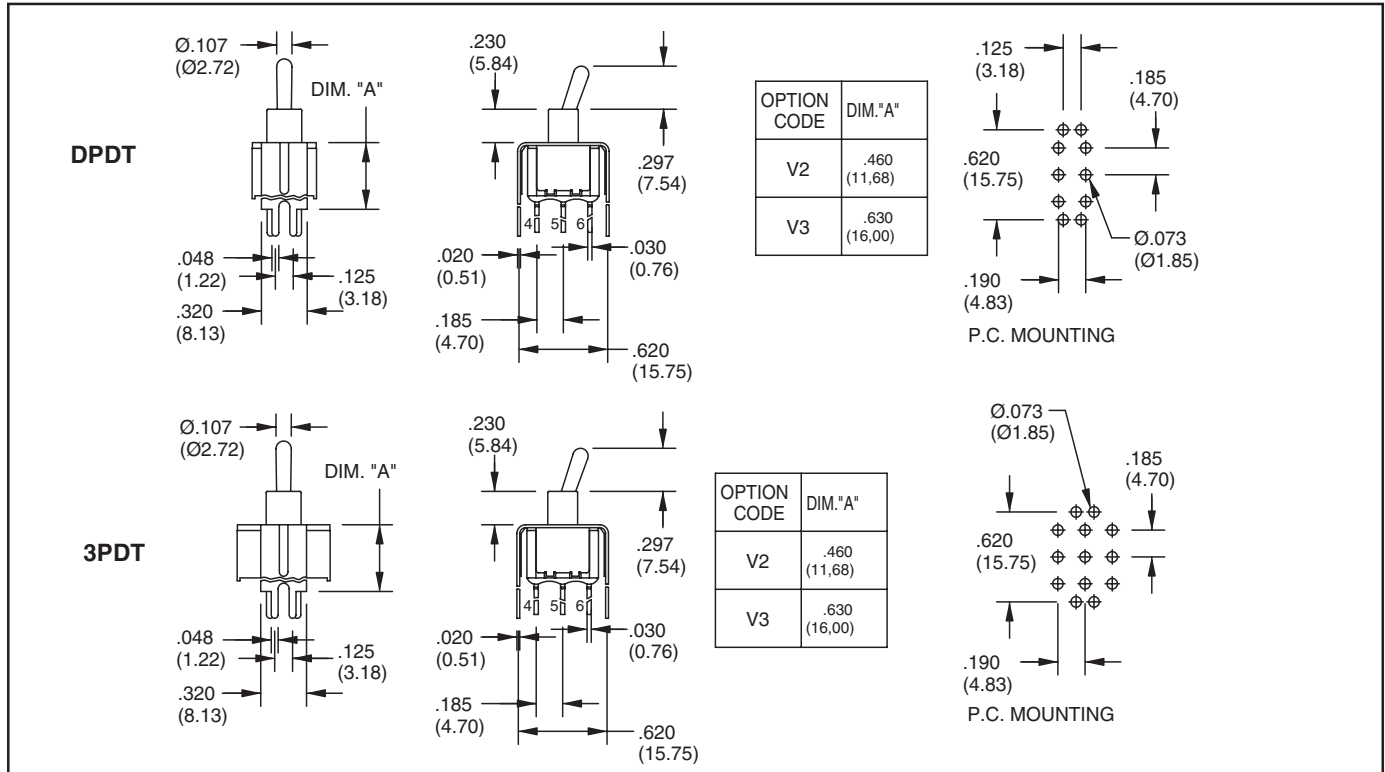

SPECIFICATIONS

RATINGS

Contact Rating: Q option - 5A with resistive load @ 125VAC or 28 VDC; 2A with resistive load @ 250 VAC. R option-0.4 VA max @ 20 Vmax (AC or DC)

Electrical Life: 50,000 make-and-break cycles at full load

Contact Resistance: 10 milliohms max.

initial @ 2-4 VDC, 100 mA

Insulation Resistance: 1,000 megaohms minimum

Dielectric Strength: 1,500 V RMS @ sea level

Operating Temperature: -30°C to 85°C

flame retardant, heat stabilized (UL94V-0)

Actuator: Brass, chrome plated. Internal O-ring seal standard with all actuators.

Frame: Spring steel

Switch Support: Brass, tin-plated

Actuator Pivot & Mounting Bracket: Nylon

Actuator Pivot Retainer: Stainless Steel

Terminal and Contacts: Copper alloy with plated over nickel or silver plate

Terminal Seal: Epoxy

MATERIALS

Case and Bushings: Glass-filled nylon 6/6,

ORDERING INFORMATION

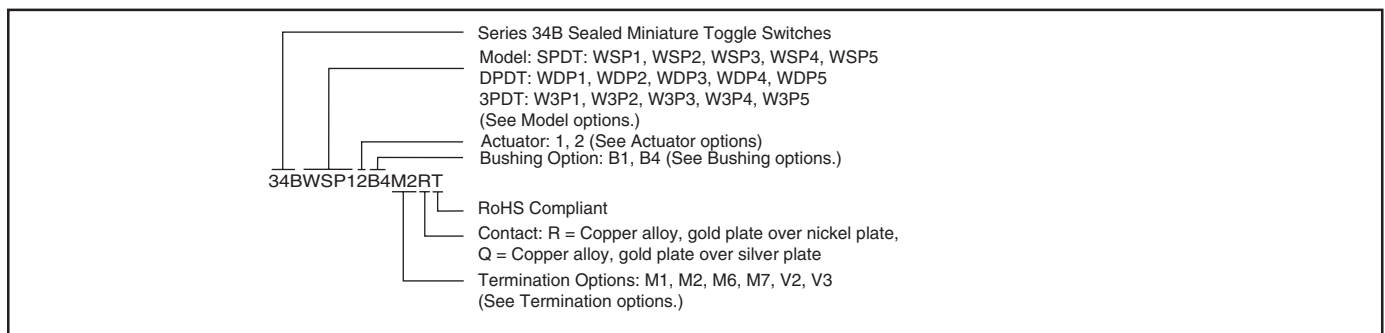

Available from your local Grayhill Component Distributor. For prices and discounts, contact a local Sales Office, an authorized local Distributor or Grayhill.

HARDWARE In inches (and millimeters)

