

1

2

3

4

A

A

B

B

C

C

D

D

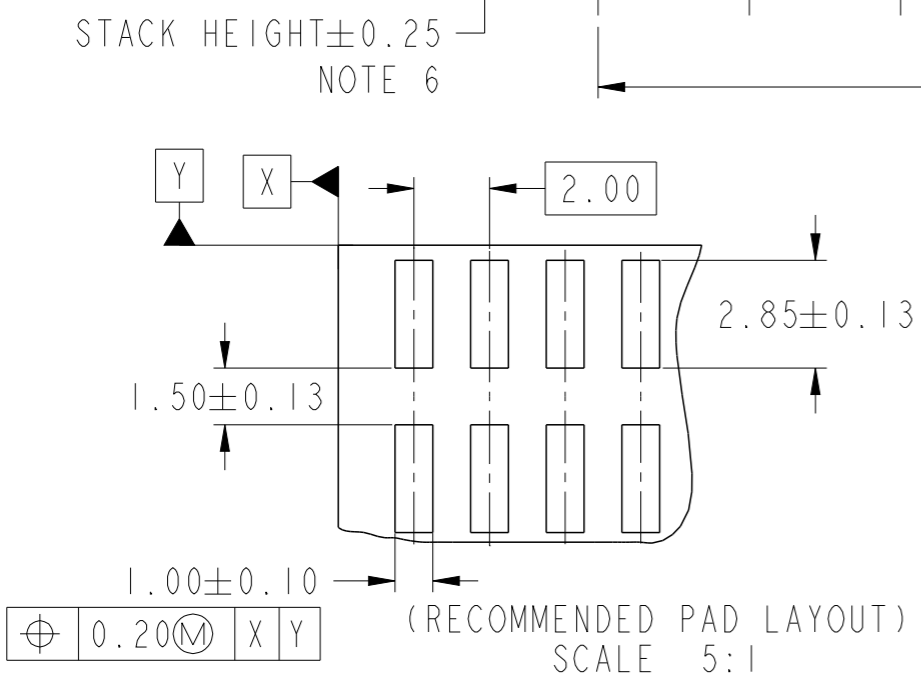
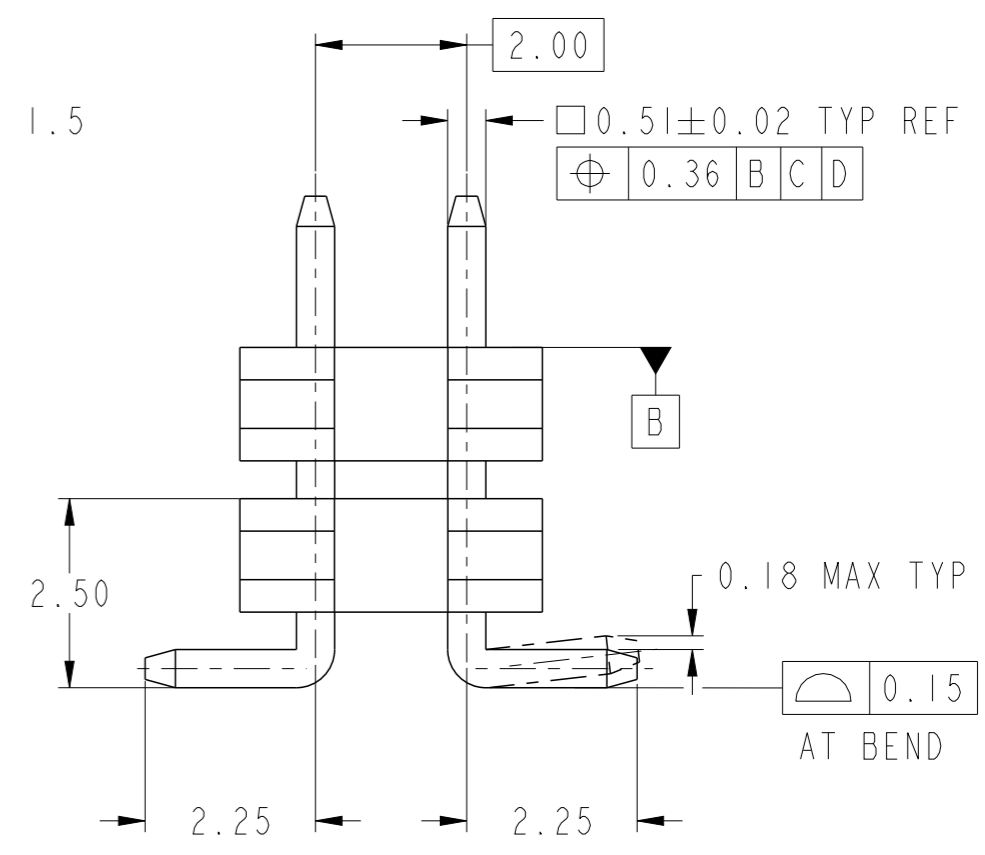
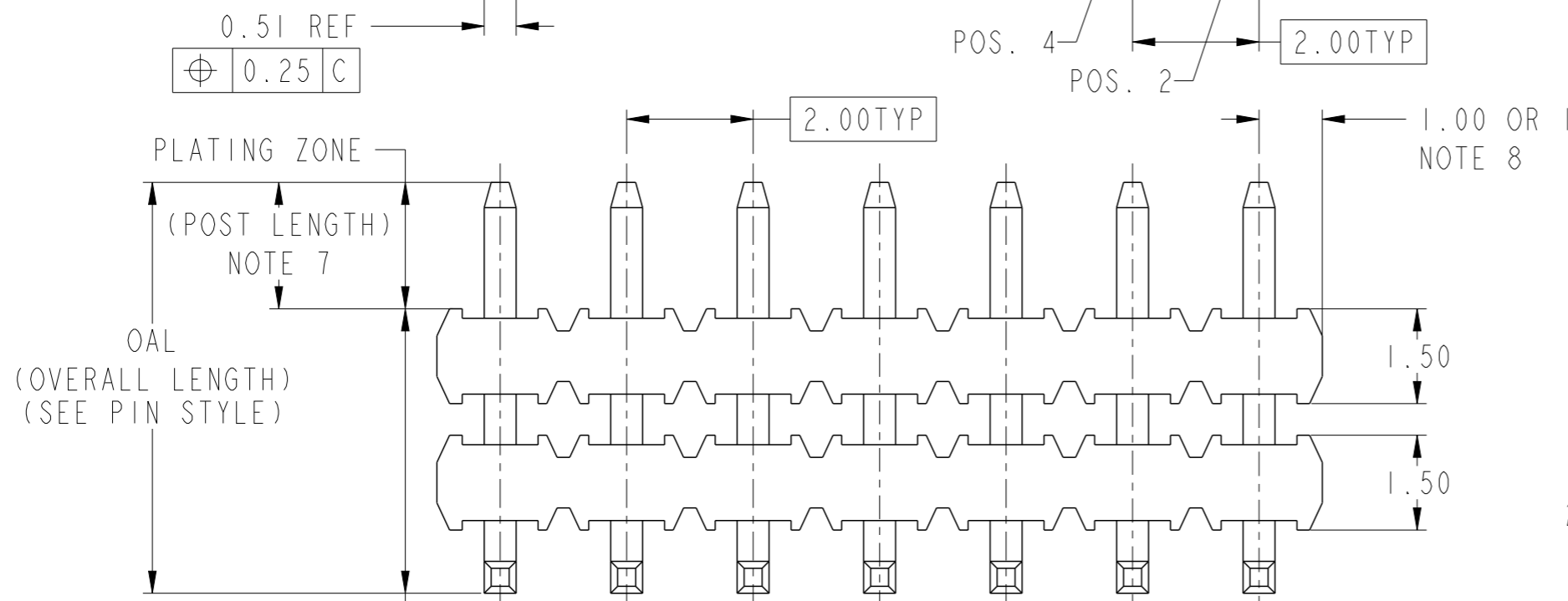
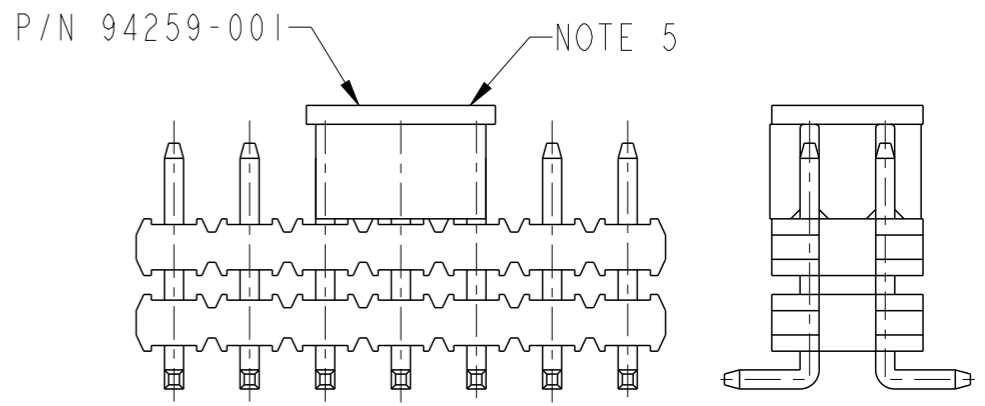
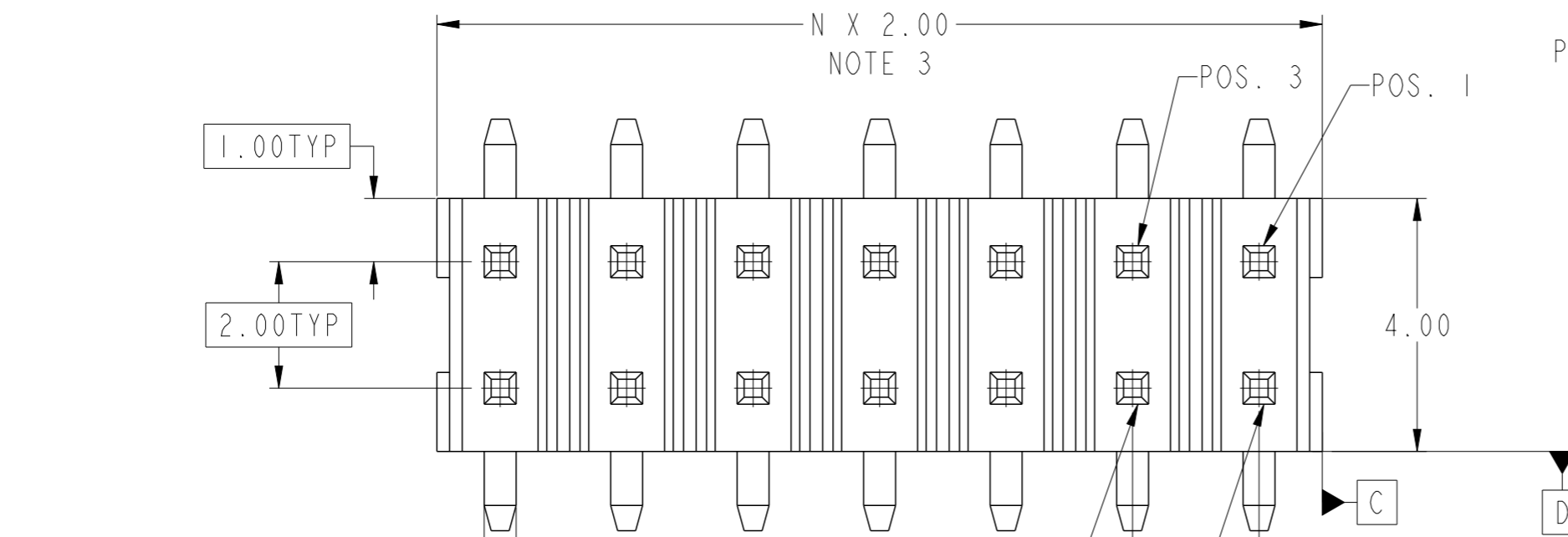

spec ref	-	dr	wcadmin	2010/11/01	projection	MM	size	A3	scale	10:1		
tolerance std	ISO 406 ISO 1101	eng	Guo-Min Sun	2014/04/01		← →	ecn no	ELX-N-17365-1				
TOLERANCES UNLESS OTHERWISE SPECIFIED		chr	-	2014/04/02				product family	MINITEK	rel level	Released	
surface	ISO 1302	appr	Rick Bian		2.00MM UNSHROUDED HEADER		dwg no	59202		rev	M	
					linear	0.X ±0.5 0.XX ±0.25 0.XXX ±0.150	www.fci.com		cat. no.	-	Product - Customer Drw	sheet 1 of 2
					angular	0° ±3°	PDS: Rev :M		STATUS:Released		Printed: Apr 03, 2014	

Copyright FCI.

DETAIL PRODUCT NUMBER

PRODUCT NUMBER DESCRIPTION:

59202 - X XX - XX - XXXLF

LEAD FREE.
SEE NOTE 9

STACKER HEIGHT
SEE NOTE 6

PACKAGING: - = STANDARD
(SEE NOTE 5) U = TUBE
P = TUBE WITH PICK-UP CAP
A = TAPE & REEL WITH
PICK-UP CAP

POSITIONS PER ROW = "N"
(02 to 25)

PLATING
S=0.38um GOLD
ON CONTACT AREA
0.38um GOLD
ON TAIL

G=0.76um GOLD
ON CONTACT AREA
0.76um GOLD
ON TAIL

F=0.20um GOLD
ON CONTACT AREA
0.20um GOLD
ON TAIL

T=0.76um GOLD ON CONTACT AREA
2.54um 100% MATTE TIN
ON TAIL

K=0.76um GXT ON CONTACT AREA
2.54um 100% MATTE TIN
ON TAIL

H=GOLD FLASH ON CONTACT AREA
2.54um 100% MATTE TIN
ON TAIL



M=2.54um MATTE TIN ON CONTACT AREA
2.54um 100% MATTE TIN
ON TAIL

PIN STYLE	OAL
22	06.5
24	07.9
26	08.5
28	10.1
30	11.9
32	12.4
34	13.9
36	15.5
38	17.4
40	19.4

NOTES:

- MATERIAL HOUSING: HIGH TEMPERATURE THERMOPLASTIC.
UL 94V-0, COLOR BLACK.
- MATERIAL TERMINAL: COPPER ALLOY.

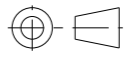
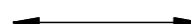
- TO DETERMINE DIMENSIONS:
N = NUMBER OF POSITIONS PER ROW.
EX. :10 POS., N x 2.00 = 20.00 TOTAL POSITIONS.
- 0.9Kg MIN. PIN RETENTION IN EITHER DIRECTION.
- PACKAGING:
(A) STANDARD PACKAGING IN POLY BAGS.
(B) SPECIAL PACKAGING IN TUBE OR TAPE AND REEL.
FOR TUBE AN OPTIONAL PICK-UP CAP IS PROVIDED
IN THE CENTER OF THE PRODUCT FOR PICK AND PLACE
APPLICATIONS. PICK-UP CAP IS STANDARD IN TAPE
AND REEL. FOR ALL SPECIAL PACKAGING, FCI MUST BE
CONTACTED FOR AVAILABILITY IN SIZE REQUESTED.
- STACK HEIGHT IS DETERMINED BY CUSTOMER
APPLICATION REQUIREMENTS. SPECIFIED IN mm.
EXAMPLE: 4.7 mm STACK HEIGHT= 59202-XXX-XX-047.
MINIMUM STACK HEIGHT IS 4.00mm.
- POST LENGTH IS DETERMINED BY: (OAL)-(STACK HGT.)=POST LGTH.
MINIMUM MATING LENGTH 2.0mm.
- DIM 1.0 APPLIES TO MOLDED SIDE(S) ONLY. IF
SIDE(S) ARE BROKEN, DIM 1.5 MAX APPLIES.
- P/N:59202-XXXLF IS SAME AS 59202-XXX. THE SUFFIX 'LF'
IS ADDED JUST FOR EASY LEAD FREE IDENTIFICATION.
- THE HOUSING WILL WITHSTAND EXPOSURE TO 255°C PEAK
TEMPERATURE FOR 10 SECONDS IN A CONVECTION, INFRA-RED
OR VAPOR PHASE REFLOW OVEN.
- THIS PRODUCT MEETS EUROPEAN UNION DIRECTIVES AND
OTHER COUNTRY REGULATIONS AS DESCRIBED IN GS-22-008.

dr	wcadmin	2010/11/01	projection	MM	size	A3	scale	10:1
eng	Guo-Min Sun	2014/04/01			ecn no ELX-N-17365-1			
chr	-	-			rel level Released			
appr	Rick Bian	2014/04/02	product family		MINITEK		rel level Released	
			2.00MM UNSHROUDED HEADER		dwg no		59202	
www.fci.com			BOARD TO BOARD SMT		rev		M	
cat. no.			-		Product - Customer Drw		sheet 2 of 2	