



Film Capacitors

Metallized Polypropylene Film Capacitors (MKP)

Series/Type: B32612 ... B32614

Date: August 2004

© EPCOS AG 2004. Reproduction, publication and dissemination of this data sheet, enclosures hereto and the information contained therein without EPCOS' prior express consent is prohibited.

Purchase orders are subject to the General Conditions for the Supply of Products and Services of the Electrical and Electronics Industry recommended by the ZVEI (German Electrical and Electronic Manufacturers' Association), unless otherwise agreed.

Pulse application (wound)

Typical applications

- TV (S-correction, flyback)
- Electronic ballasts

Climatic

- Max. operating temperature: 110 °C
- Climatic category (IEC 60068-1): 55/100/56

Construction

- Dielectric: polypropylene (PP)
- Wound capacitor technology
- Epoxy resin coating (UL 94 V-0)

Features

- Very high pulse strength

Terminals

- Crimped wire leads, lead-free tinned, lead length (6 – 1 mm) or min. 20 mm
- Double crimped wire leads, lead-free tinned
- Straight wire leads, lead-free tinned, lead length (17 ±3) mm
- Different lead spacings (reduced and enlarged) available, lead length (6 – 1 mm)

Marking

Manufacturer's logo, style and type (P61x),
rated capacitance (coded),
capacitance tolerance (code letter),
rated DC voltage, date of manufacture (code)

Delivery mode

Bulk (untaped)

Taped (Ammo pack or reel)

For notes on taping, refer to chapter "Taping and packing".



Dimensional drawings

Crimped leads

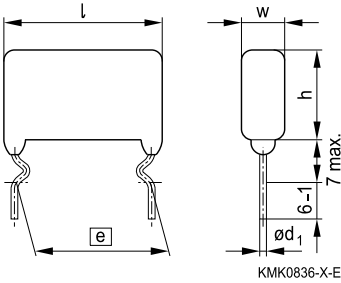

Double crimped leads

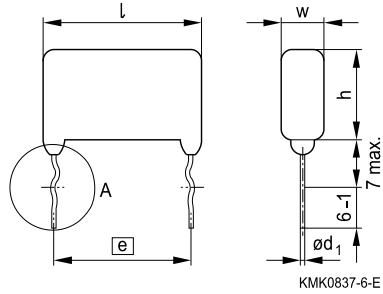

Straight leads

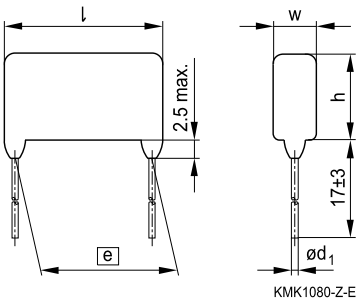

Detail of double crimped version

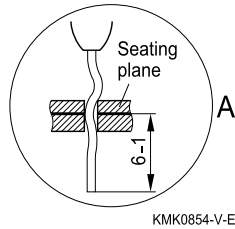

Dimensions in mm

Lead spacing	Lead diameter	Type
$e \pm 0.8$	d_1	
15.0	0.8	B32612
22.5	0.8	B32613
27.5	0.8	B32614

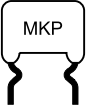





B32612 ... B32614

Pulse application (wound)

Overview of available types

Lead spacing	15.0 mm								22.5 mm							
Type	B32612								B32613							
Page	6								8							
V_R (VDC)	250	400	630	1000	1250	1600	1600	2000	250	400	630	1000	1600	2000	2000	
V_{rms} (VAC)	160	200	250	250	500	500	700	700	160	200	250	250	500	700	1000	
C_R (nF)																
1.0																
1.5																
2.2																
3.3																
4.7																
6.8																
10																
15																
22																
33																
47																
68																
100																
150																
220																
330																
470																
680																
1000																





Lead configurations

Serie	Standard	Reduced	Enlarged	Straight	Double crimped
					
B32612	15 mm	7.5 / 10 / 12.5 mm	17.5 mm	15 mm	15 mm
B32613	22.5 mm	15 / 17.5 / 20 mm	25 mm	22.5 mm	22.5 mm
B32614	27.5 mm	25 mm	–	27.5 mm	27.5 mm

Overview of available types

Lead spacing	27.5 mm					
Type	B32614					
Page	10					
V_R (VDC)	250	400	630	1000	1600	2000
V_{rms} (VAC)	160	200	250	250	500	700
C_R (nF)						
10						
15						
22						
33						
47						
68						
100						
150						
220						
470						
680						
1000						
1500						
2200						

Lead configurations

Serie	Standard	Reduced	Enlarged	Straight	Double crimped
					
B32612	15 mm	7.5 / 10 / 12.5 mm	17.5 mm	15 mm	15 mm
B32613	22.5 mm	15 / 17.5 / 20 mm	25 mm	22.5 mm	22.5 mm
B32614	27.5 mm	25 mm	–	27.5 mm	27.5 mm

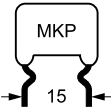
B32612
Pulse application (wound)
Ordering codes and packing units (lead spacing 15 mm)

V_R VDC	V_{rms} $f \leq 1$ kHz VAC	C_R nF	Max. dimensions $w \times h \times l$ mm	Ordering code (composition see below)	Ammo pack pcs./unit	Reel pcs./unit	Untaped pcs./unit
250	160	150	6.5 × 12.5 × 18.0	B32612A3154+***	850	1100	1000
		220	7.0 × 13.5 × 18.0	B32612A3224+***	800	1000	1000
		330	8.0 × 14.5 × 18.0	B32612A3334+***	700	900	500
		470	9.5 × 16.0 × 18.0	B32612A3474+***	600	800	500
		680	11.5 × 17.5 × 18.0	B32612A3684+***	500	650	500
400	200	68	6.5 × 12.0 × 18.0	B32612A4683+***	850	1100	1000
		100	7.0 × 12.5 × 18.0	B32612A4104+***	800	1000	1000
		150	7.5 × 12.5 × 18.0	B32612A4154+***	750	1000	1000
		220	8.0 × 14.5 × 18.0	B32612A4224+***	700	900	500
		330	9.5 × 16.0 × 18.0	B32612A4334+***	600	800	500
		470	11.0 × 17.5 × 18.0	B32612A4474+***	500	650	500
630	250	68	6.5 × 12.0 × 18.0	B32612A6683+***	850	1100	1000
		100	7.5 × 13.0 × 18.0	B32612A6104+***	750	1000	1000
		150	9.0 × 14.5 × 18.0	B32612A6154+***	600	800	500
		220	10.0 × 16.5 × 18.0	B32612A6224+***	550	750	500
1000	250	10	7.0 × 12.5 × 18.0	B32612A0103+***	800	1000	1000
		15	8.0 × 13.5 × 18.0	B32612A0153+***	700	900	1000
		22	9.0 × 15.5 × 18.0	B32612A0223+***	600	800	1000
		33	6.5 × 13.0 × 18.0	B32612A0333+***	850	1100	1000
		47	7.0 × 15.5 × 18.0	B32612A0473+***	800	1000	1000
		68	8.5 × 16.5 × 18.0	B32612A0683+***	650	850	500
		100	11.0 × 17.5 × 18.0	B32612A0104+***	500	650	500

Further E series and intermediate capacitance values on request.

Composition of ordering code

+ = Capacitance tolerance code:

K = ±10%

J = ±5%

*** = Packaging code:

289 = Ammo pack

189 = Reel

010 = Untaped crimped (lead length 6 – 1 mm)

011 = Untaped crimped (lead length min. 20 mm)

008 = Untaped (straight, lead length 17±3 mm)

020 = Double crimped (lead length 6 – 1 mm)

Packaging codes for further lead configurations (untaped):

Lead configuration (lead length 6 – 1 mm)	Reduced	Reduced	Reduced	Enlarged
Lead spacing (mm)	7.5 mm	10 mm	12.5 mm	17.5 mm
Packaging code	030	040	050	060

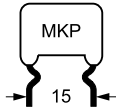
Ordering codes and packing units (lead spacing 15 mm)

V_R	V_{rms} $f \leq 1$ kHz VAC	C_R nF	Max. dimensions $w \times h \times l$ mm	Ordering code (composition see below)	Ammo pack pcs./unit	Reel pcs./unit	Untaped pcs./unit
1250	500	6.8	$7.0 \times 11.0 \times 18.0$	B32612A7682+***	800	1000	1000
		10	$7.5 \times 13.0 \times 18.0$	B32612A7103+***	750	1000	1000
		15	$8.0 \times 14.0 \times 18.0$	B32612A7153+***	700	900	500
		22	$9.5 \times 15.5 \times 18.0$	B32612A7223+***	600	800	500
		33	$11.0 \times 17.5 \times 18.0$	B32612A7333+***	500	650	500
1600	500	4.7	$6.5 \times 12.0 \times 18.0$	B32612A1472+***	850	1100	1000
		6.8	$8.0 \times 13.0 \times 18.0$	B32612A1682+***	700	900	500
		10	$9.0 \times 14.5 \times 18.0$	B32612A1103+***	600	800	500
		15	$10.0 \times 17.5 \times 18.0$	B32612A1153+***	550	750	500
1600	700	3.3	$6.5 \times 11.5 \times 18.0$	B32612J1332+***	850	1100	1000
		4.7	$7.5 \times 12.5 \times 18.0$	B32612J1472+***	750	1000	1000
		6.8	$8.5 \times 14.5 \times 18.0$	B32612J1682+***	650	850	500
		10	$9.5 \times 17.0 \times 18.0$	B32612J1103+***	600	800	250
2000	700	1.0	$7.0 \times 10.5 \times 18.0$	B32612A2102+***	800	1000	1000
		1.5	$7.5 \times 11.5 \times 18.0$	B32612A2152+***	750	1000	1000
		2.2	$8.0 \times 14.5 \times 18.0$	B32612A2222+***	700	900	1000
		3.3	$8.5 \times 15.0 \times 18.0$	B32612A2332+***	650	850	500
		4.7	$9.5 \times 18.0 \times 18.0$	B32612A2472+***	600	800	500

Further E series and intermediate capacitance values on request.

Composition of ordering code

+ = Capacitance tolerance code:

K = $\pm 10\%$

J = $\pm 5\%$

*** = Packaging code:

289 = Ammo pack

189 = Reel

010 = Untaped crimped (lead length 6 – 1 mm)

011 = Untaped crimped (lead length min. 20 mm)

008 = Untaped (straight, lead length 17 ± 3 mm)

020 = Double crimped (lead length 6 – 1 mm)

Packaging codes for further lead configurations (untaped):

Lead configuration (lead length 6 – 1 mm)	Reduced	Reduced	Reduced	Enlarged
Lead spacing (mm)	7.5 mm	10 mm	12.5 mm	17.5 mm
Packaging code	030	040	050	060

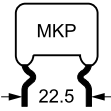
B32613
Pulse application (wound)
Ordering codes and packing units (lead spacing 22.5 mm)

V_R VDC	V_{rms} $f \leq 1$ kHz VAC	C_R nF	Max. dimensions $w \times h \times l$ mm	Ordering code (composition see below)	Ammo pack pcs./unit	Reel pcs./unit	Untaped pcs./unit
250	160	220	$7.0 \times 14.5 \times 26.5$	B32613A3224+***	500	700	500
		330	$7.0 \times 14.5 \times 26.5$	B32613A3334+***	500	700	500
		470	$8.0 \times 15.5 \times 26.5$	B32613A3474+***	450	600	500
		680	$9.5 \times 16.0 \times 26.5$	B32613A3684+***	350	500	500
		1000	$11.0 \times 19.0 \times 26.5$	B32613A3105+***	300	450	250
400	200	150	$7.0 \times 13.5 \times 26.5$	B32613A4154+***	500	700	500
		220	$7.0 \times 14.0 \times 26.5$	B32613A4224+***	500	700	500
		330	$8.0 \times 16.0 \times 26.5$	B32613A4334+***	450	600	500
		470	$9.5 \times 16.0 \times 26.5$	B32613A4474+***	350	500	250
		680	$11.5 \times 17.5 \times 26.5$	B32613A4684+***	300	400	250
630	250	100	$7.0 \times 12.5 \times 26.5$	B32613A6104+***	500	700	250
		150	$7.5 \times 14.0 \times 26.5$	B32613A6154+***	450	650	250
		220	$9.0 \times 15.5 \times 26.5$	B32613A6224+***	400	550	250
		330	$10.0 \times 18.0 \times 26.5$	B32613A6334+***	350	500	250
		470	$11.0 \times 20.0 \times 26.5$	B32613A6474+***	300	450	250
1000	250	33	$8.5 \times 14.5 \times 26.5$	B32613A0333+***	400	550	500
		47	$10.0 \times 15.5 \times 26.5$	B32613A0473+***	350	500	250
		68	$11.0 \times 17.5 \times 26.5$	B32613A0683+***	300	450	250
		100	$10.0 \times 16.5 \times 26.5$	B32613A0104+***	350	500	250
		150	$12.0 \times 18.0 \times 26.5$	B32613A0154+***	300	400	250
1600	500	10	$7.0 \times 13.5 \times 26.5$	B32613A1103+***	500	700	500
		15	$8.0 \times 14.5 \times 26.5$	B32613A1153+***	450	600	500
		22	$9.0 \times 17.0 \times 26.5$	B32613A1223+***	400	550	250
		33	$10.5 \times 18.5 \times 26.5$	B32613A1333+***	350	450	250

Further E series and intermediate capacitance values on request.

Composition of ordering code

+ = Capacitance tolerance code:

 K = $\pm 10\%$

 J = $\pm 5\%$

*** = Packaging code:

289 = Ammo pack

189 = Reel

010 = Untaped crimped (lead length 6 – 1 mm)

011 = Untaped crimped (lead length min. 20 mm)

 008 = Untaped (straight, lead length 17 ± 3 mm)

020 = Double crimped (lead length 6 – 1 mm)

Packaging codes for further lead configurations (untaped):

Lead configuration (lead length 6 – 1 mm)	Reduced	Reduced	Reduced	Enlarged
Lead spacing (mm)	15 mm	17.5 mm	20 mm	25 mm
Packaging code	055	060	030	080

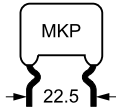
Ordering codes and packing units (lead spacing 22.5 mm)

V_R	V_{rms} $f \leq 1$ kHz VDC	C_R nF	Max. dimensions $w \times h \times l$ mm	Ordering code (composition see below)	Ammo pack pcs./unit	Reel pcs./unit	Untaped pcs./unit
2000	700	3.3	$7.0 \times 13.0 \times 26.5$	B32613A2332+***	500	700	500
		4.7	$7.5 \times 14.0 \times 26.5$	B32613A2472+***	450	650	500
		6.8	$8.5 \times 16.0 \times 26.5$	B32613A2682+***	400	550	500
		10	$10.5 \times 17.0 \times 26.5$	B32613A2103+***	350	450	250
		15	$12.0 \times 20.5 \times 26.5$	B32613A2153+***	300	400	250
2000	1000	3.3	$8.0 \times 14.5 \times 26.5$	B32613A8332+***	450	600	500
		4.7	$8.5 \times 16.5 \times 26.5$	B32613A8472+***	400	550	250
		6.8	$10.0 \times 18.5 \times 26.5$	B32613A8682+***	350	500	250
		10	$11.5 \times 21.5 \times 26.5$	B32613A8103+***	300	400	250

Further E series and intermediate capacitance values on request.

Composition of ordering code

+ = Capacitance tolerance code:

K = $\pm 10\%$

J = $\pm 5\%$

*** = Packaging code:

289 = Ammo pack

189 = Reel

010 = Untaped crimped (lead length 6 – 1 mm)

011 = Untaped crimped (lead length min. 20 mm)

008 = Untaped (straight, lead length 17 ± 3 mm)

020 = Double crimped (lead length 6 – 1 mm)

Packaging codes for further lead configurations (untaped):

Lead configuration (lead length 6 – 1 mm)	Reduced	Reduced	Reduced	Enlarged
Lead spacing (mm)	15 mm	17.5 mm	20 mm	25 mm
Packaging code	055	060	030	080

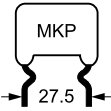
B32614
Pulse application (wound)
Ordering codes and packing units (lead spacing 27.5 mm)

V_R VDC	V_{rms} $f \leq 1$ kHz VAC	C_R nF	Max. dimensions $w \times h \times l$ mm	Ordering code (composition see below)	Untaped pcs./unit
250	160	470	7.0 × 15.0 × 31.5	B32614A3474+***	500
		680	8.0 × 16.5 × 31.5	B32614A3684+***	500
		1000	9.5 × 17.5 × 31.5	B32614A3105+***	200
		1500	11.5 × 19.5 × 31.5	B32614A3155+***	200
		2200	14.0 × 22.0 × 31.5	B32614A3225+***	200
400	200	470	9.5 × 15.0 × 31.5	B32614A4474+***	200
		680	10.0 × 17.5 × 31.5	B32614A4684+***	200
		1000	11.5 × 19.5 × 31.5	B32614A4105+***	200
		1500	14.0 × 22.0 × 31.5	B32614A4155+***	200
		2200	16.5 × 24.5 × 31.5	B32614A4225+***	150
630	250	470	10.5 × 18.5 × 31.5	B32614A6474+***	200
		680	12.0 × 21.5 × 31.5	B32614A6684+***	200
		1000	14.0 × 24.0 × 31.5	B32614A6105+***	200
1000	250	100	11.5 × 17.5 × 31.5	B32614A0104+***	500
		150	13.0 × 21.0 × 31.5	B32614A0154+***	200
		220	14.5 × 24.5 × 31.5	B32614A0224+***	200
1600	500	22	9.0 × 14.5 × 31.5	B32614A1223+***	500
		33	10.5 × 16.0 × 31.5	B32614A1333+***	500
		47	11.0 × 19.5 × 31.5	B32614A1473+***	200
		68	13.0 × 21.5 × 31.5	B32614A1683+***	200
2000	700	10	9.0 × 15.5 × 31.5	B32614A2103+***	500
		15	11.0 × 17.5 × 31.5	B32614A2153+***	200
		22	13.0 × 19.5 × 31.5	B32614A2223+***	200
		33	14.5 × 23.0 × 31.5	B32614A2333+***	200
		47	16.5 × 25.5 × 31.5	B32614A2473+***	150

Further E series and intermediate capacitance values on request.

Composition of ordering code

+ = Capacitance tolerance code:

K = ±10%

J = ±5%

*** = Packaging code:

010 = Untaped crimped (lead length 6 – 1 mm)

011 = Untaped crimped (lead length min. 20 mm)

008 = Untaped (straight, lead length 17±3 mm)

020 = Double crimped (lead length 6 – 1 mm)

Packaging codes for further lead configurations (untaped):

Lead configuration (lead length 6 – 1 mm)	Reduced
Lead spacing (mm)	25 mm
Packaging code	090

Technical data

Operating temperature range	Max. operating temperature $T_{op,max}$ +110 °C			
	Upper category temperature T_{max} +100 °C			
	Lower category temperature T_{min} -55 °C			
	Rated temperature T_R +85 °C			
Dissipation factor $\tan \delta$ (in 10^{-3}) at 20 °C (upper limit values)	at	$C_R \leq 0.1 \mu F$	$0.1 \mu F < C_R \leq 1 \mu F$	$C_R > 1 \mu F$
	1 kHz	–	0.5	0.5
	10 kHz	–	0.8	1.5
	100 kHz	5.0	–	–
Insulation resistance R_{ins} or time constant $\tau = C_R \cdot R_{ins}$ at 20 °C, rel. humidity $\leq 65\%$ (minimum as-delivered values)	$C_R \leq 0.33 \mu F$		$C_R > 0.33 \mu F$	
	100 G Ω		30000 s	
DC test voltage	1.6 · V_R , 2 s			
Category voltage V_C (continuous operation with V_{DC} or V_{AC} at $f \leq 1$ kHz)	T_A (°C)	DC voltage derating	AC voltage derating	
	$T_A \leq 85$ $85 < T_A \leq 100$	$V_C = V_R$ $V_C = V_R \cdot (165 - T_A)/80$	$V_{C,rms} = V_{rms}$ $V_{C,rms} = V_{rms} \cdot (165 - T_A)/80$	
Operating voltage V_{op} for short operating periods (V_{DC} or V_{AC} at $f \leq 1$ kHz)	T_A (°C)	DC voltage (max. hours)	AC voltage (max. hours)	
		$V_{op} = 1.25 \cdot V_C$ (2000 h) $V_{op} = 1.25 \cdot V_C$ (1000 h)	$V_{op} = 1.0 \cdot V_{C,rms}$ (2000 h) $V_{op} = 1.0 \cdot V_{C,rms}$ (1000 h)	
Damp heat test Limit values after damp heat test	56 days/40 °C/93% relative humidity			
	Capacitance change $ \Delta C/C $		$\leq 3\%$	
	Dissipation factor change $\Delta \tan \delta$		$\leq 0.5 \cdot 10^{-3}$ (at 1 kHz) $\leq 1.0 \cdot 10^{-3}$ (at 10 kHz)	
	Insulation resistance R_{ins} or time constant $\tau = C_R \cdot R_{ins}$		$\geq 50\%$ of minimum as-delivered values	
Reliability: Failure rate λ Service life t_{SL}	1 fit ($\leq 1 \cdot 10^{-9}$ /h) at 0.5 · V_R , 40 °C 200 000 h at 1.0 · V_R , 40 °C For conversion to other operating conditions and temperatures, refer to chapter "Quality assurance", page .			
Failure criteria: Total failure Failure due to variation of parameters	Short circuit or open circuit			
	Capacitance change $ \Delta C/C $		$> 10\%$	
	Dissipation factor $\tan \delta$		$> 4 \cdot$ upper limit value	
	Insulation resistance R_{ins} or time constant $\tau = C_R \cdot R_{ins}$		< 1500 M Ω ($C_R \leq 0.33 \mu F$) < 500 s ($C_R > 0.33 \mu F$)	

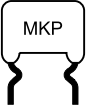

B32612 ... B32614

Pulse application (wound)

Characteristic voltages V_{DC} , V_{AC} , V_{pp}

V_{DC} V	V_{AC} V	V_{pp} V
1000	250	700
1250	500	1250
1600	500	1400
1600	700	1600
2000	700	1600
2000	1000	2000

Pulse handling capability

"dV/dt" represents the maximum permissible voltage change per unit of time for non-sinusoidal voltages, expressed in V/ μ s.

"k₀" represents the maximum permissible pulse characteristic of the waveform applied to the capacitor, expressed in V²/ μ s.

Note:

The values of dV/dt and k₀ provided below must not be exceeded in order to avoid damaging the capacitor.

dV/dt values

Lead spacing		15 mm	22.5 mm	27.5 mm
V _R VDC	V _{rms} VAC	dV/dt in V/ μ s		
250	160	140	80	50
400	200	200	100	70
630	250	270	140	100
1000	250	400	350	225
1250	500	800	–	–
1600	500	1500	1000	700
1600	700	1900	–	–
2000	700	2200	1400	900
2000	1000	–	2000	–

k₀ values

Lead spacing		15 mm	22.5 mm	27.5 mm
V _R VDC	V _{rms} VAC	k ₀ in V ² / μ s		
250	160	70 000	40 000	25 000
400	200	160 000	80 000	55 000
630	250	340 000	170 000	120 000
1000	250	800 000	675 000	450 000
1250	500	2 000 000	–	–
1600	500	4 800 000	3 200 000	2 200 000
1600	700	6 100 000	–	–
2000	700	8 800 000	5 600 000	3 600 000
2000	1000	–	10 000 000	–

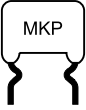

B32612 ... B32614

Pulse application (wound)

Impedance Z versus frequency f
(typical values)

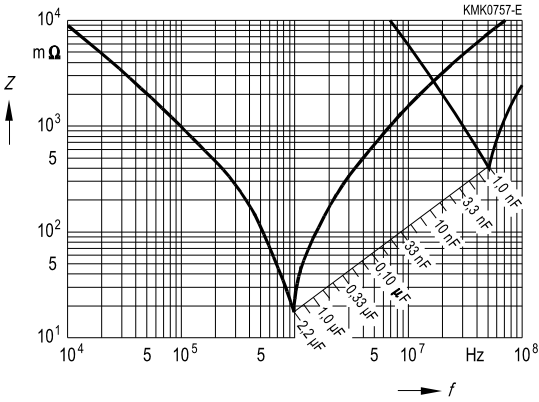

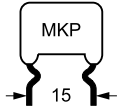

Permissible AC voltage V_{rms} versus frequency f (for sinusoidal waveforms, $T_A \leq 90^\circ C$)

For $T_A > 90^\circ C$, please refer to "General technical information", section 3.2.3.

Lead spacing 15 mm

250 VDC/160 VAC

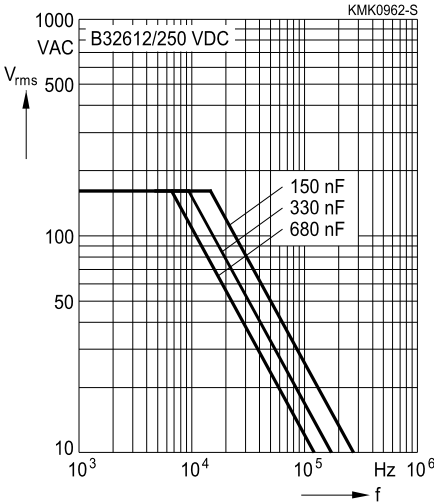

400 VDC/200 VAC

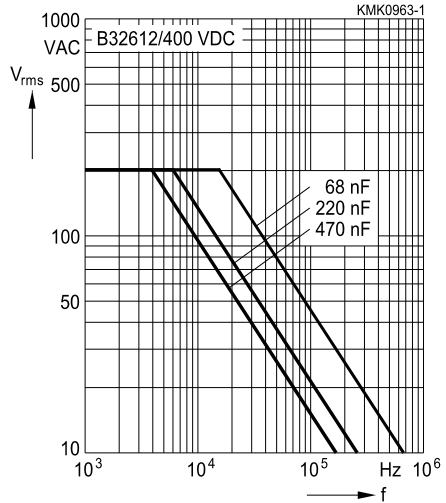

630 VDC/250 VAC

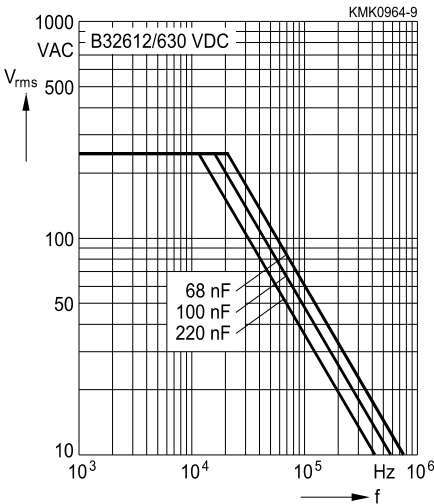

1000 VDC/250 VAC

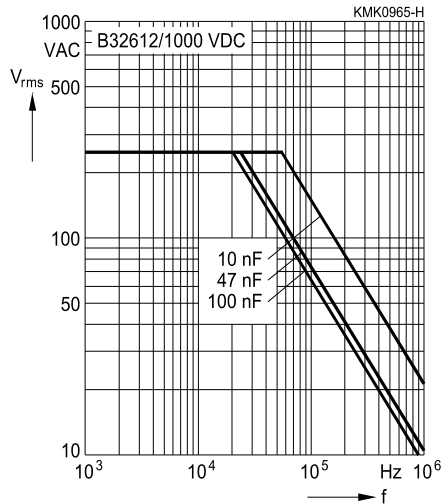

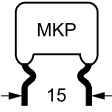

B32612

Pulse application (wound)

Permissible AC voltage V_{rms} versus frequency f (for sinusoidal waveforms, $T_A \leq 90^\circ\text{C}$)

For $T_A > 90^\circ\text{C}$, please refer to "General technical information", section 3.2.3.

Lead spacing 15 mm

1250 VDC/500 VAC

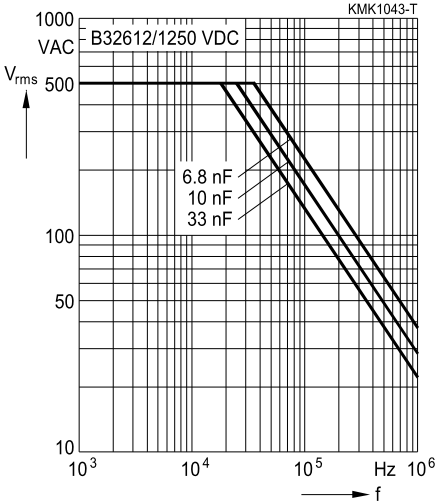

1600 VDC/500 VAC

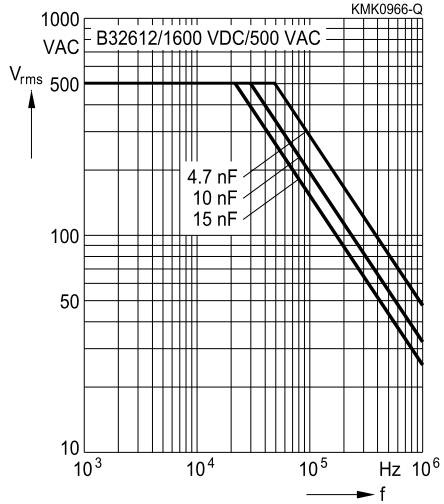

1600 VDC/700 VAC

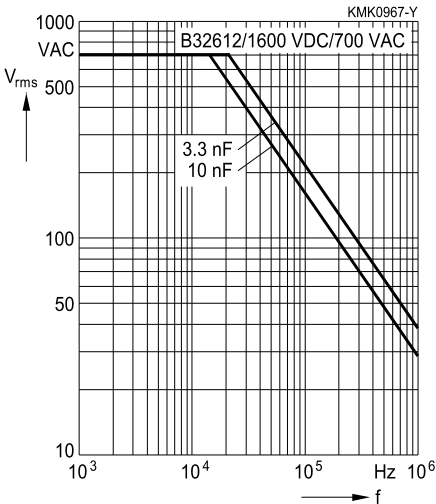

2000 VDC/700 VAC

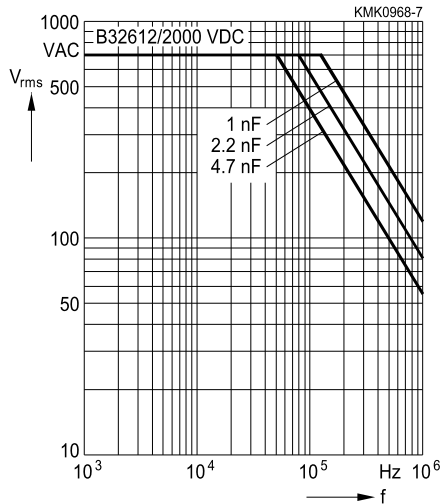

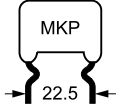

Permissible AC voltage V_{rms} versus frequency f (for sinusoidal waveforms, $T_A \leq 90^\circ\text{C}$)

For $T_A > 90^\circ\text{C}$, please refer to "General technical information", section 3.2.3.

Lead spacing 22.5 mm

250 VDC/160 VAC

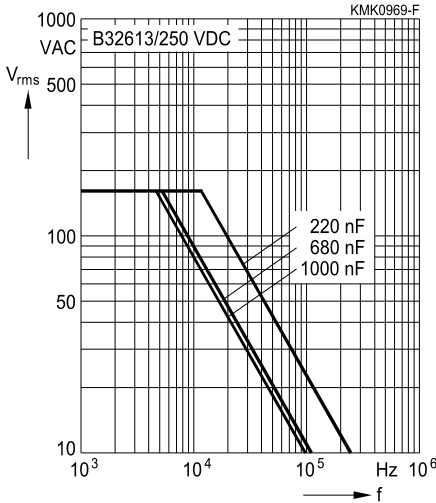

400 VDC/200 VAC

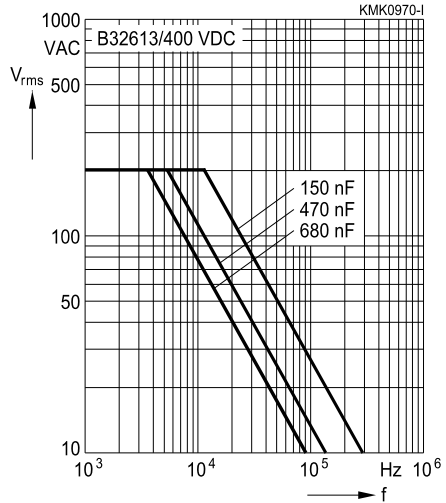

630 VDC/250 VAC

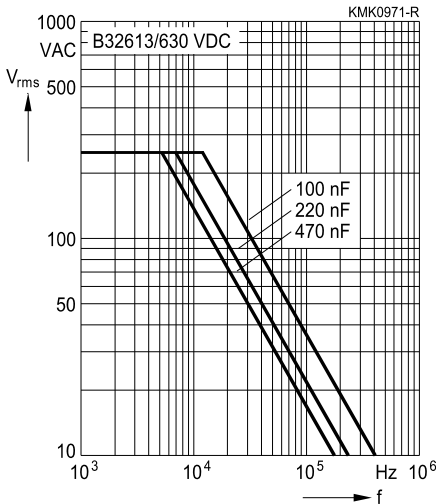

1000 VDC/250 VAC

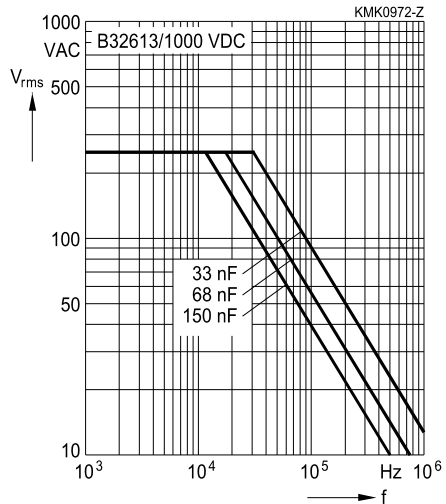

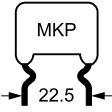

B32613

Pulse application (wound)

Permissible AC voltage V_{rms} versus frequency f (for sinusoidal waveforms, $T_A \leq 90^\circ C$)

For $T_A > 90^\circ C$, please refer to "General technical information", section 3.2.3.

Lead spacing 22.5 mm

1600 VDC/500 VAC

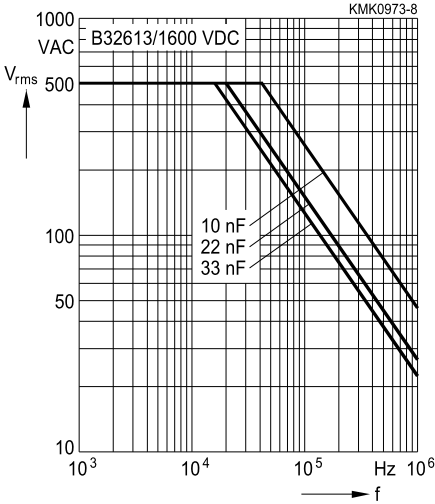

2000 VDC/700 VAC

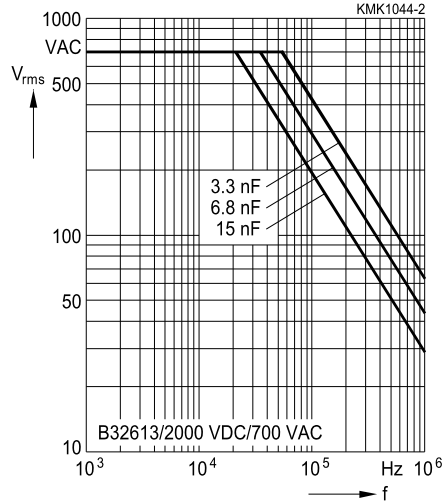

2000 VDC/1000 VAC

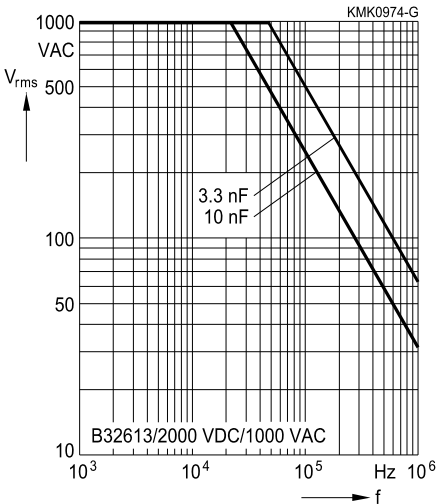

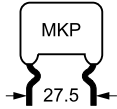
Permissible AC voltage V_{rms} versus frequency f (for sinusoidal waveforms, $T_A \leq 90^\circ\text{C}$)

 For $T_A > 90^\circ\text{C}$, please refer to "General technical information", section 3.2.3.

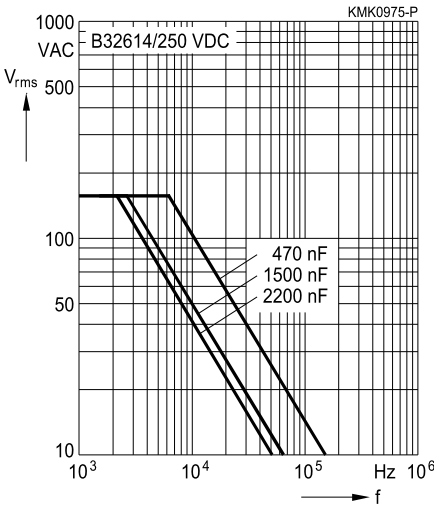
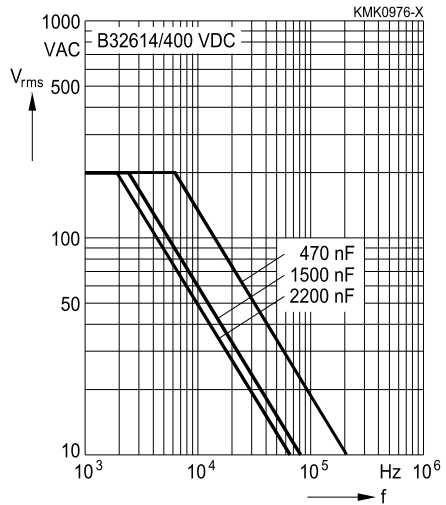
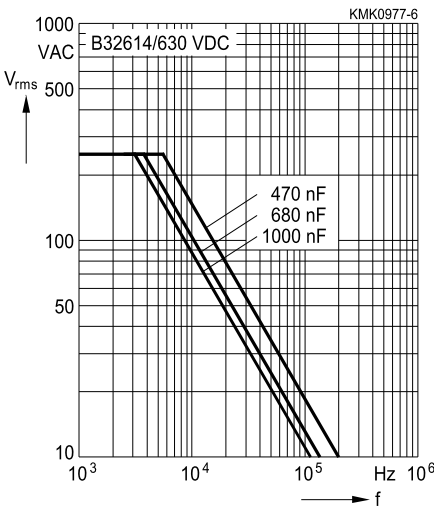
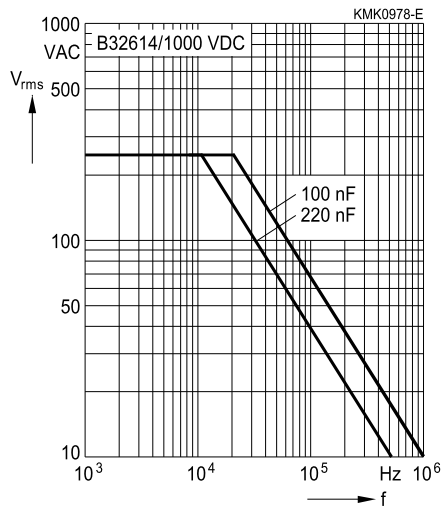
Lead spacing 27.5 mm
250 VDC/160 VAC

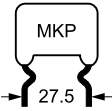
400 VDC/200 VAC

630 VDC/250 VAC

1000 VDC/250 VAC



B32614

Pulse application (wound)

Permissible AC voltage V_{rms} versus frequency f (for sinusoidal waveforms, $T_A \leq 90^\circ\text{C}$)

For $T_A > 90^\circ\text{C}$, please refer to "General technical information", section 3.2.3.

Lead spacing 27.5 mm

1600 VDC/500 VAC

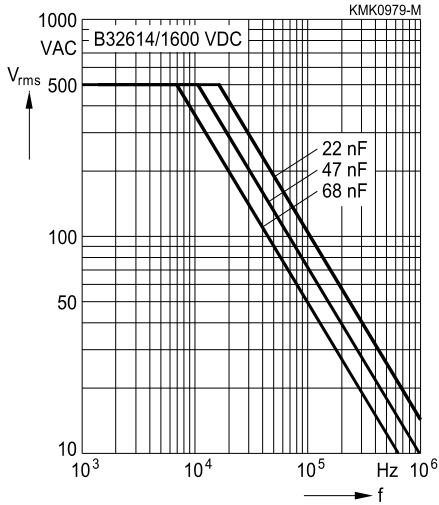

2000 VDC/700 VAC

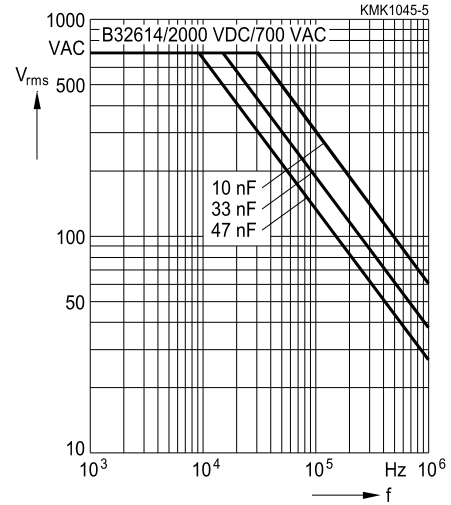



Flyback application

Permissible voltage and current / waveform

Permissible current I_{pp} versus frequency f for a duty cycle of 20% ($t_0/t = 0.2$):

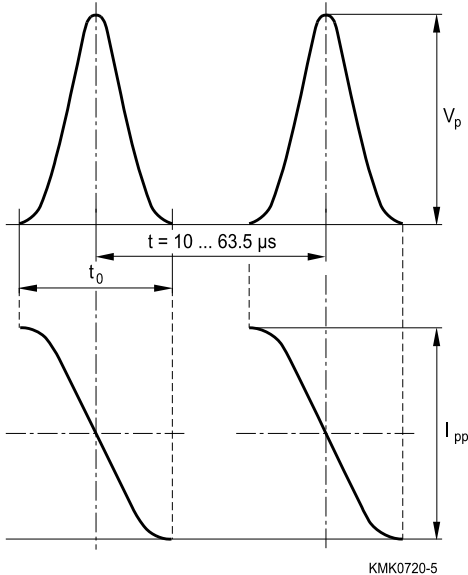

Approximation formular for duty cycle higher than 20%:

$$I'_{pp} = I_{pp} \cdot \sqrt{\frac{t_0^3}{t^3}}$$

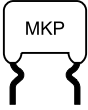

B32612 ... B32614

Pulse application (wound)

Flyback application

Permissible current I_{pp} versus rated capacitance C_R

Frequency = 15.75 kHz

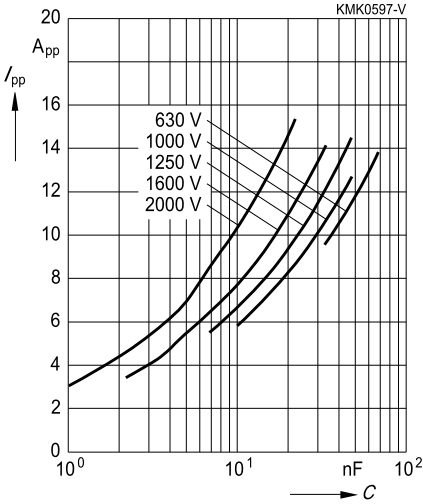

Frequency = 31.5 kHz

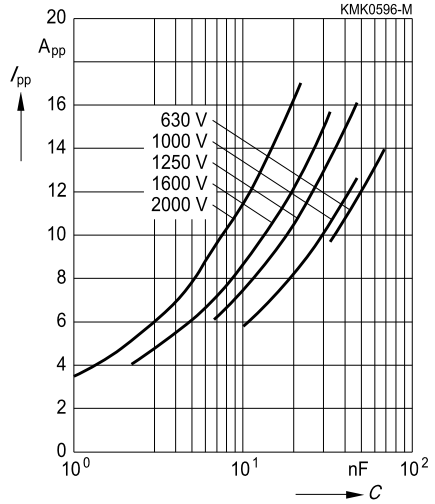

Frequency = 95 kHz

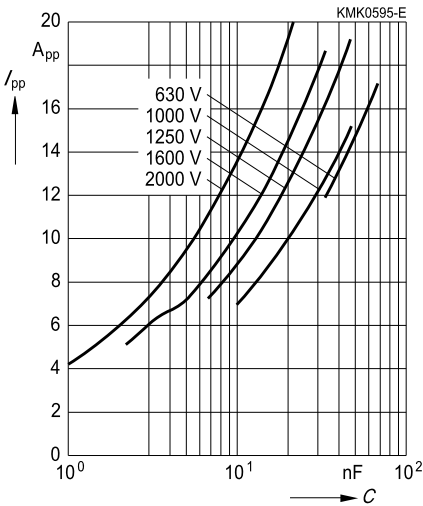



S-correction application

Permissible voltage and current / waveform

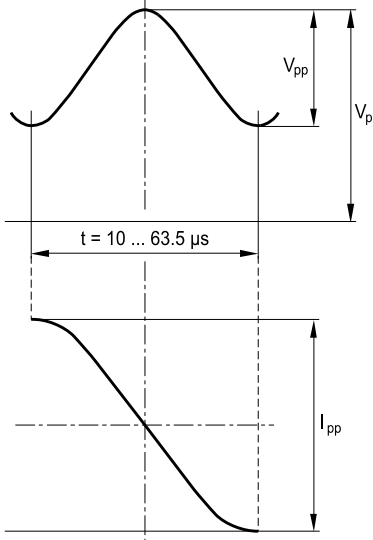

KMK0721-D

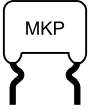

B32612 ... B32614

Pulse application (wound)

S-correction application

Permissible current I_{pp} versus rated capacitance C_R

Frequency = 15.75 kHz

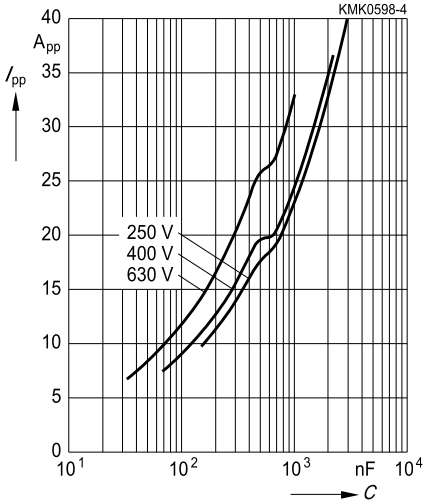

Frequency = 31.75 kHz

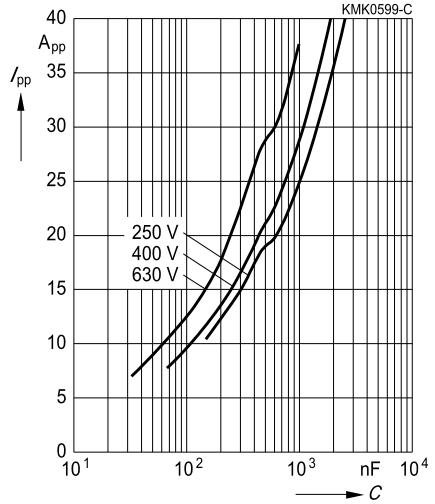

Frequency = 95 kHz

