

# MIC94325/45/55



## 500mA LDO with Ripple Blocker™ Technology



### General Description

The MIC943x5 Ripple Blocker™ is a monolithic integrated circuit that provides low-frequency ripple attenuation (switching noise rejection) to a regulated output voltage. This is important for applications where a DC/DC switching converter is required to lower or raise a battery voltage but where switching noise cannot be tolerated by sensitive downstream circuits such as in RF applications. The MIC943x5 maintains high power supply ripple rejection (PSRR) with input voltages operating near the output voltage level to improve overall system efficiency. A low-voltage logic enable pin facilitates ON/OFF control at typical GPIO voltage levels.

The MIC943x5 operates from an input voltage of 1.8V to 3.6V. The MIC943x5 options include fixed (MIC94345/55) or adjustable (MIC94325) output voltages. The MIC94355 version offers an auto-discharge to discharge the output capacitor when the part is disabled.

Packaged in a 0.84mm x 1.32mm 6-ball CSP or a 6-pin 1.6mm x 1.6mm Thin DFN, the MIC943x5 has a junction operating temperature range of  $-40^{\circ}\text{C}$  to  $+125^{\circ}\text{C}$ .

Data sheets and support documentation can be found on Micrel's web site at: [www.micrel.com](http://www.micrel.com).

### Features

- 1.8V to 3.6V input voltage range
- Active noise rejection over a wide frequency band
  - $>50\text{dB}$  from 10Hz to 5MHz at 500mA load
- Rated to 500mA output current
- Fixed and adjustable output voltages
- Optional output auto-discharge when disabled
- Current-limit and thermal-limit protected
- Ultra-small 0.84mm x 1.32mm 6-ball CSP
- 1.6mm x 1.6mm, 6-pin Thin DFN
- Logic-controlled enable pin
- $-40^{\circ}\text{C}$  to  $+125^{\circ}\text{C}$  junction temperature range

### Applications

- Smart phones
- Tablet PC/notebooks and webcams
- Digital still and video cameras
- Global positioning systems
- Mobile computing
- Automotive and industrial applications

### Typical Application

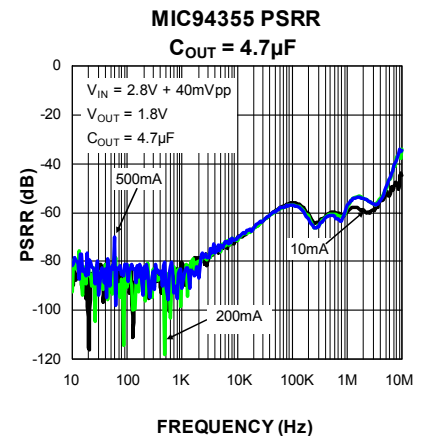
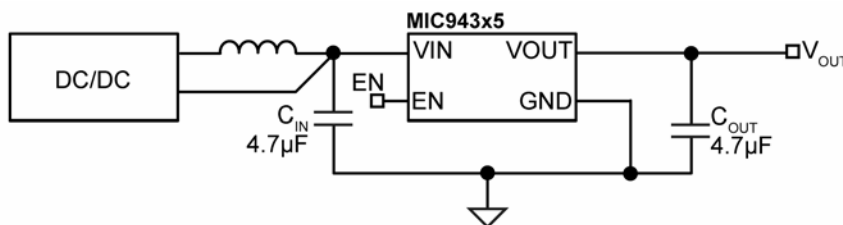

Ripple Blocker is a trademark of Micrel, Inc

Micrel Inc. • 2180 Fortune Drive • San Jose, CA 95131 • USA • tel +1 (408) 944-0800 • fax + 1 (408) 474-1000 • <http://www.micrel.com>

## Ordering Information

Part Number	Marking Code	Output Voltage	Auto Discharge	Package <sup>1</sup>	Lead Finish
MIC94325YMT	2R	ADJ	—	1.6mm x 1.6mm Thin DFN	Pb-Free
MIC94345-4YCS*	L4	1.2V	—	0.84mm x 1.32mm CSP	Pb-Free
MIC94345-FYCS*	LF	1.5V	—	0.84mm x 1.32mm CSP	Pb-Free
MIC94345-GYCS*	X1	1.8V	—	0.84mm x 1.32mm CSP	Pb-Free
MIC94345-MYCS*	X2	2.8V	—	0.84mm x 1.32mm CSP	Pb-Free
MIC94345-SYCS*	X3	3.3V	—	0.84mm x 1.32mm CSP	Pb-Free
MIC94345-4YMT*	4L	1.2V	—	1.6mm x 1.6mm Thin DFN	Pb-Free
MIC94345-FYMT*	FL	1.5V	—	1.6mm x 1.6mm Thin DFN	Pb-Free
MIC94345-GYMT*	1X	1.8V	—	1.6mm x 1.6mm Thin DFN	Pb-Free
MIC94345-MYMT*	2X	2.8V	—	1.6mm x 1.6mm Thin DFN	Pb-Free
MIC94345-SYMT*	3X	3.3V	—	1.6mm x 1.6mm Thin DFN	Pb-Free
MIC94355-4YCS*	G9	1.2V	Yes	0.84mm x 1.32mm CSP	Pb-Free
MIC94355-FYCS*	G0	1.5V	Yes	0.84mm x 1.32mm CSP	Pb-Free
MIC94355-GYCS*	G1	1.8V	Yes	0.84mm x 1.32mm CSP	Pb-Free
MIC94355-MYCS*	G2	2.8V	Yes	0.84mm x 1.32mm CSP	Pb-Free
MIC94355-SYCS*	G3	3.3V	Yes	0.84mm x 1.32mm CSP	Pb-Free
MIC94355-4YMT*	9G	1.2V	Yes	1.6mm x 1.6mm Thin DFN	Pb-Free
MIC94355-FYMT*	0G	1.5V	Yes	1.6mm x 1.6mm Thin DFN	Pb-Free
MIC94355-GYMT	2G	1.8V	Yes	1.6mm x 1.6mm Thin DFN	Pb-Free
MIC94355-MYMT*	7G	2.8V	Yes	1.6mm x 1.6mm Thin DFN	Pb-Free
MIC94355-SYMT*	8G	3.3V	Yes	1.6mm x 1.6mm Thin DFN	Pb-Free

### Notes:

1. Thin DFN is a GREEN RoHS-compliant package. Lead finish is NiPdAu. Mold compound is Halogen Free.

\* Contact Micrel Marketing for availability.

## Pin Configuration

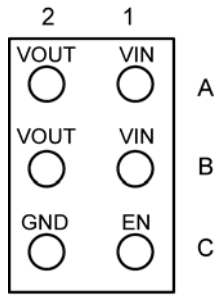

**6-Ball 0.84mm × 1.32mm CSP (CS)**  
Ball View

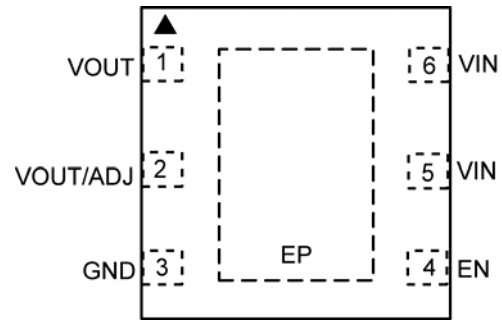

**6-Pin 1.6mm × 1.6mm Thin DFN (MT)**  
Top View

**Note:**

- Thin DFN ▲ = Pin 1 identifier.

## Pin Description

Pin Number (Thin DFN) Fixed	Pin Number (Thin DFN) Adjustable	Ball Number (CSP) Fixed	Pin Name	Pin Name
1, 2	1	A2, B2	VOUT	Power Switch Output.
-	2	-	ADJ	Adjust input. Connect to resistive divider at VOUT to set the output voltage. Do not leave floating.
3	3	C2	GND	Ground.
4	4	C1	EN	Enable Input. A logic HIGH signal on this pin enables the part. Logic LOW disables the part. Do not leave floating.
5, 6	5, 6	A1, B1	VIN	Power Switch Input And Chip Supply.
EP	EP	-	ePad	Exposed Heatsink Pad. Connect to Ground plane for best thermal performance.

## Functional Block Diagrams

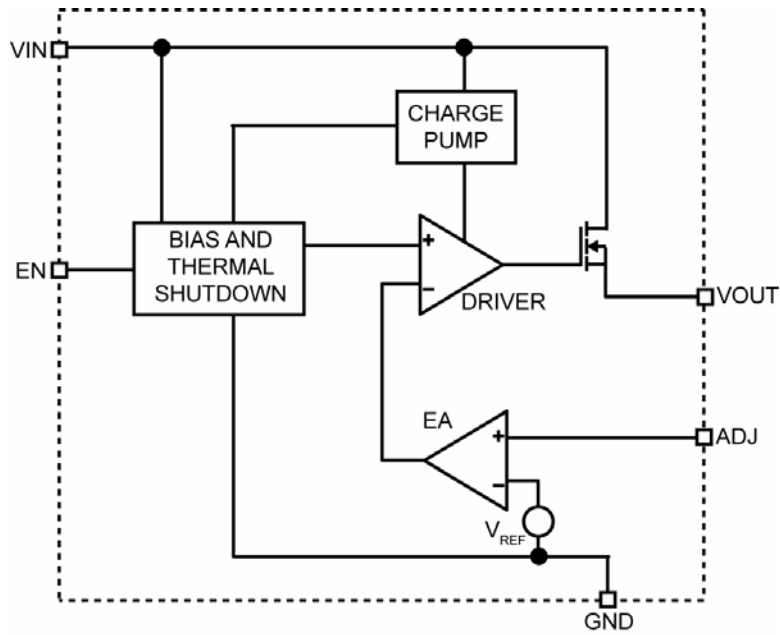

**MIC94325 Adjustable Output**

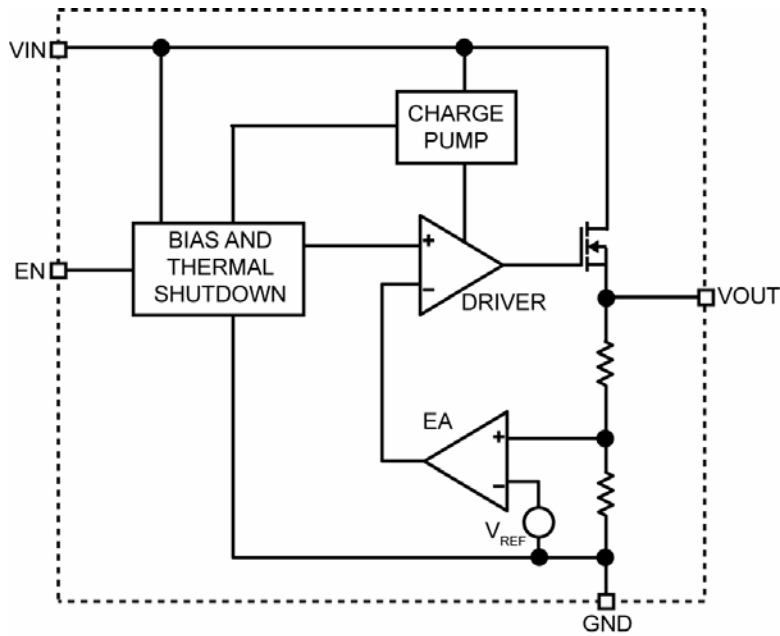

**MIC94345 Fixed Output**

### Functional Block Diagrams (Continued)

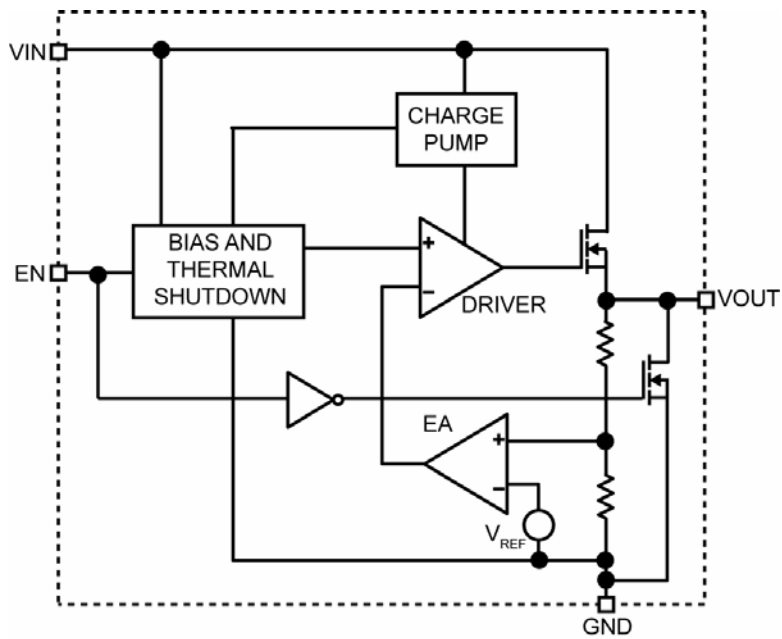

MIC94355 Fixed Output with Auto-Discharge

**Absolute Maximum Ratings<sup>(1)</sup>**

Input Voltage ( $V_{IN}$ )	-0.3 to +4V
Output Voltage ( $V_{OUT}$ )	-0.3 to $V_{IN}+0.3V$ or +4V
Enable Voltage ( $V_{EN}$ )	-0.3 to $V_{IN}+0.3V$ or +4V
Lead Temperature (soldering, 10s)	260°C
Storage Temperature ( $T_s$ )	-65°C to +150°C
ESD Rating <sup>(3)</sup>	3kV

**Operating Ratings<sup>(2)</sup>**

Input Voltage ( $V_{IN}$ )	+1.8V to +3.6V
Enable Voltage ( $V_{EN}$ )	0V to $V_{IN}$
Junction Temperature ( $T_J$ )	-40°C to +125°C
Junction Thermal Resistance	
Thin DFN ( $\theta_{JA}$ )	92°C/W
CSP ( $\theta_{JA}$ )	160°C/W

**Electrical Characteristics<sup>(4)</sup>**

$V_{IN} = V_{EN} = V_{OUT} + 500mV$  ( $V_{IN} = V_{EN} = 3.6V$  for  $V_{OUT} \geq 3.1V$ );  $I_{OUT} = 1mA$ ;  $C_{OUT} = 4.7\mu F$ ;  $T_A = 25^\circ C$ ,  
**bold** values indicate  $-40^\circ C \leq T_J \leq +125^\circ C$ , unless noted.

Parameter	Condition	Min.	Typ.	Max.	Units
Input Voltage		<b>1.8</b>		<b>3.6</b>	V
Output Voltage Range	MIC94325	<b>1.2</b>		<b>3.4</b>	V
Output Voltage Accuracy	Variation from nominal $V_{OUT}$	<b>-3</b>	$\pm 1$	<b>+3</b>	%
Adjust Reference	MIC94325		1.1		V
Dropout Voltage	$V_{IN}$ to $V_{OUT}$ dropout at 50mA output current		10		mV
	$V_{IN}$ to $V_{OUT}$ dropout at 500mA output current		100	<b>200</b>	
Load Regulation	1mA to 500mA		10		mV
Line Regulation	$V_{IN} = V_{OUT} + 500mV$ to 3.6V, $I_{OUT} = 100mA$		0.1	<b>1</b>	%
Ground Current	$I_{OUT} = 100\mu A$		170	<b>250</b>	$\mu A$
Shutdown Current	$V_{EN} = 0V$		0.2	5	$\mu A$
$V_{IN}$ Ripple Rejection	f = 100Hz		85		dB
	f = 1KHz		85		
	f = 100KHz		57		
	f = 1MHz		60		
	f = 5MHz		50		
Current Limit	$V_{OUT} = 0V$	<b>530</b>	800	<b>1100</b>	mA
Total Output Noise	10Hz to 100kHz		83		$\mu V_{RMS}$
Turn-On Time			100	<b>150</b>	$\mu s$
Auto Discharge NFET Resistance	$V_{IN} = 3.6V$ , $V_{EN} = 0V$ , $I_{OUT} = -3mA$ MIC94355 Only		50		$\Omega$
<b>Enable</b>					
Input Logic Low				<b>0.35</b>	V
Input Logic High		<b>1.0</b>			V
Input Current			0.01	1	$\mu A$

**Notes:**

- Exceeding the absolute maximum rating may damage the device.
- The device is not guaranteed to function outside its operating rating.
- Devices are ESD sensitive. Handling precautions recommended. Human body model, 1.5k $\Omega$  in series with 100pF.
- Specification for packaged product only.

# Typical Characteristics

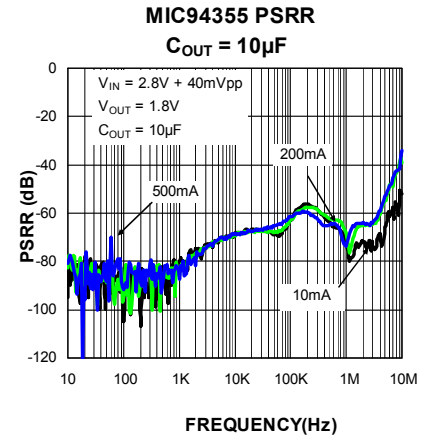
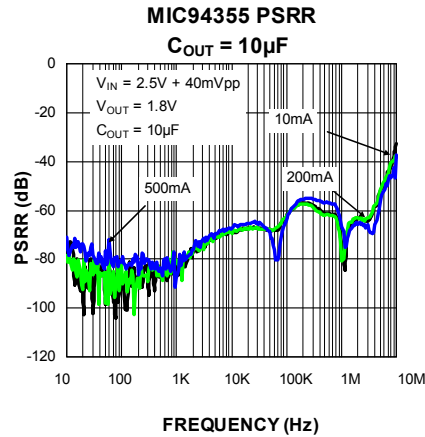
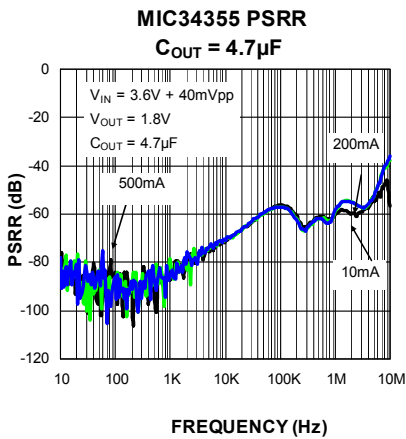
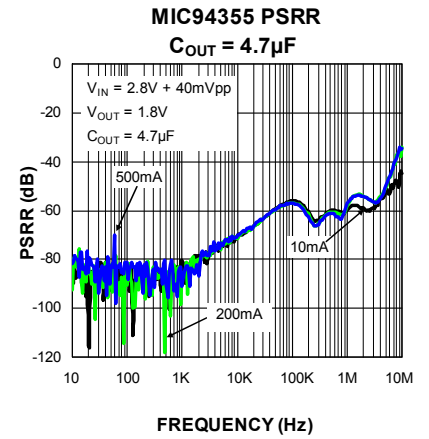
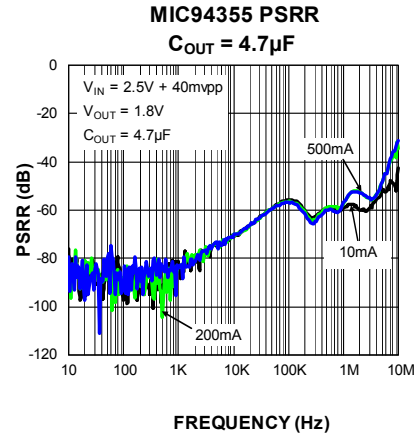
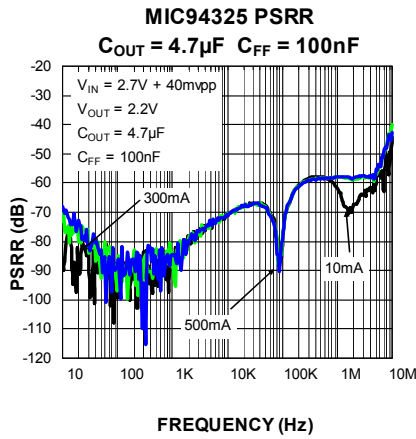
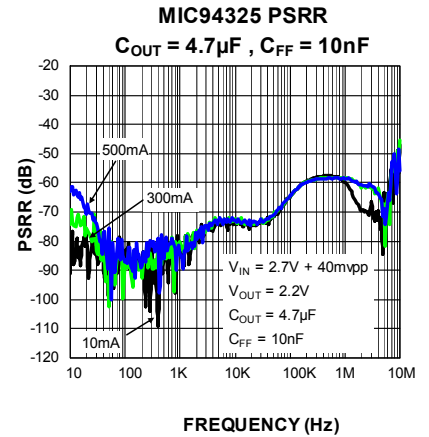
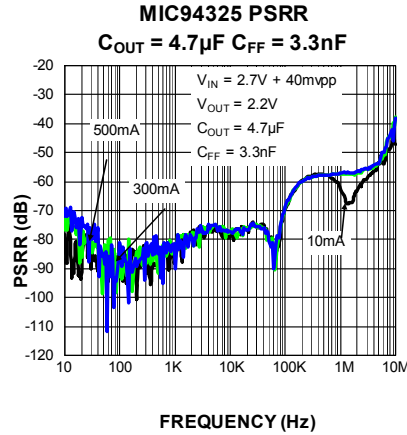
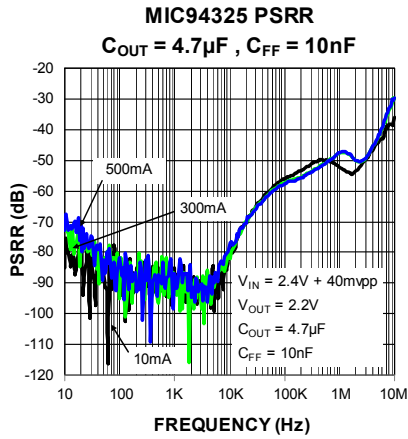

## Typical Characteristics (Continued)

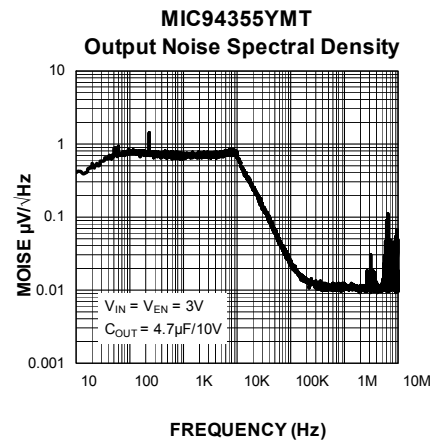
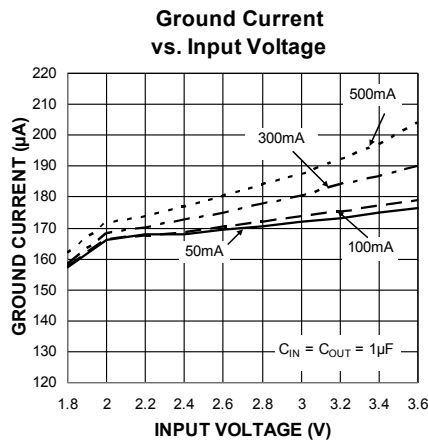
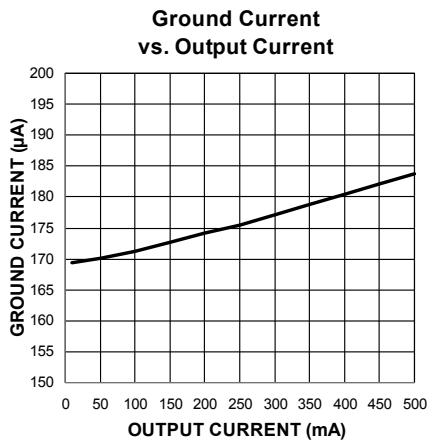
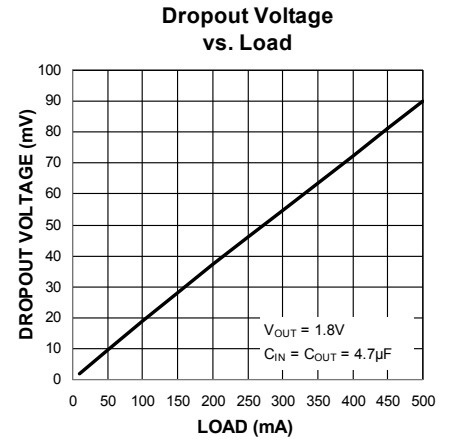
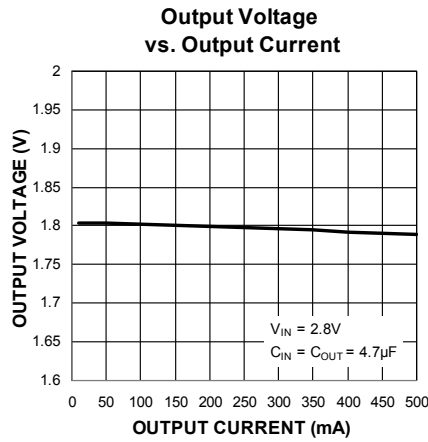
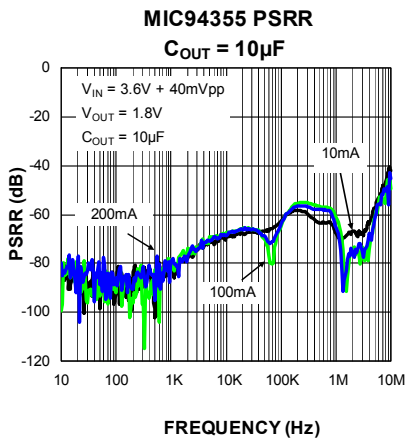



## Functional Characteristics

**Load Transient**

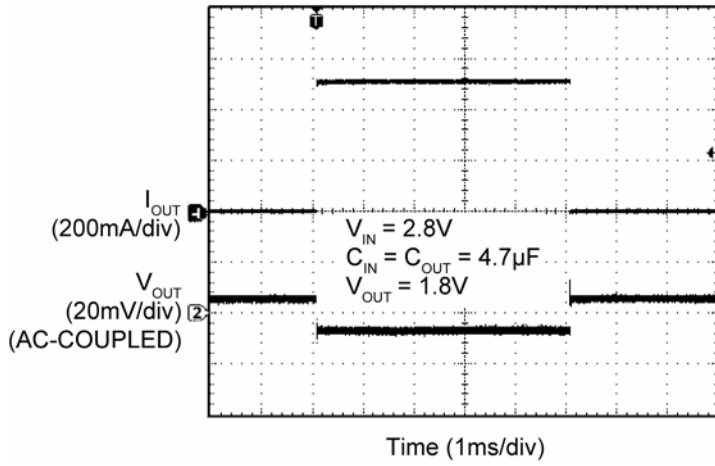

**Line Transient**

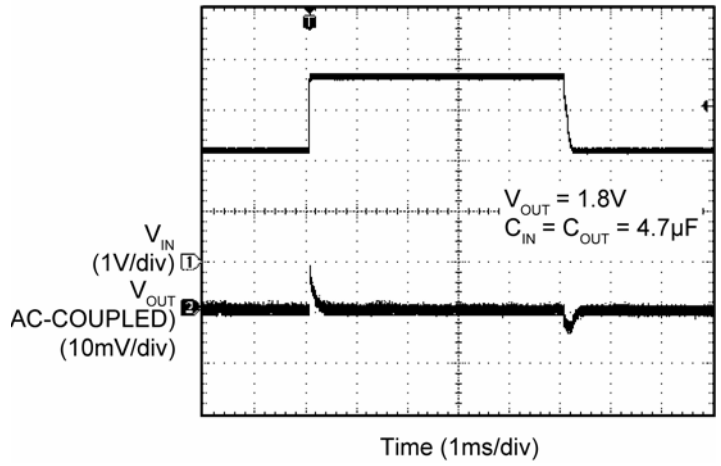

**Turn-On Time**

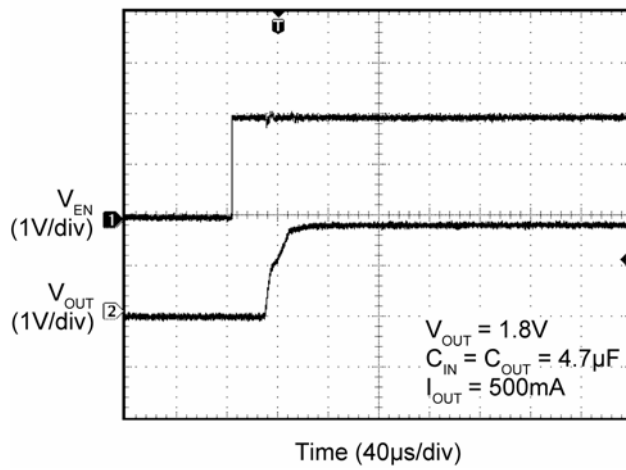

**Turn-Off Time (Auto Discharge)**

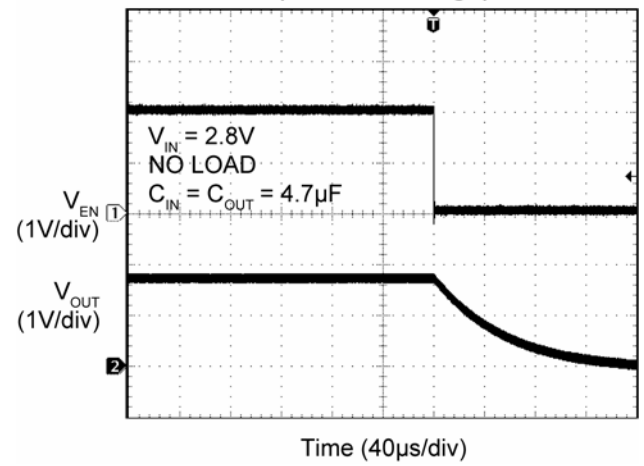

## Application Information

The MIC943x5 family of products is a very-high PSRR, fixed-output, 500mA LDO utilizing Ripple Blocker technology. The MIC943x5 is fully protected from damage due to fault conditions, offering linear current limiting and thermal shutdown.

### Input Capacitor

The MIC943x5 is a high-performance, high-bandwidth device. An input capacitor of 4.7 $\mu$ F is required from the input to ground to provide stability. Low-ESR ceramic capacitors provide optimal performance at a minimum of space. Additional high-frequency capacitors, such as small-valued NPO dielectric-type capacitors, help filter out high-frequency noise and are good practice in any RF-based circuit. X5R or X7R dielectrics are recommended for the input capacitor. Y5V dielectrics lose most of their capacitance over temperature and are therefore, not recommended.

### Output Capacitor

In order to maintain stability, the MIC943x5 requires an output capacitor of 4.7 $\mu$ F or greater. For optimal input voltage ripple rejection performance a 4.7 $\mu$ F capacitor is recommended. The design is optimized for use with low-ESR ceramic chip capacitors. High-ESR capacitors are not recommended because they may cause high-frequency oscillation. The output capacitor can be increased, but performance has been optimized for a 4.7 $\mu$ F ceramic output capacitor and does not improve significantly with larger capacitance.

X7R/X5R dielectric type ceramic capacitors are recommended because of their temperature performance. X7R type capacitors change capacitance by 15% over their operating temperature range and are the most stable type of ceramic capacitors. Z5U and Y5V dielectric capacitors change their value by as much as 50% and 60%, respectively, over their operating temperature ranges. To use a ceramic chip capacitor with the Y5V dielectric, the value must be much higher than an X7R ceramic capacitor to ensure the same minimum capacitance over the equivalent operating temperature range.

### No Load Stability

The MIC943x5 will remain stable and in regulation with no load. This is especially important in CMOS RAM keep-alive applications.

### Enable/Shutdown

Forcing the enable (EN) pin low disables the MIC943x5 and sends it into a “zero” off mode current state. In this state, current consumed by the MIC943x5 goes nearly to zero. Forcing EN high enables the output voltage. The EN pin uses CMOS technology and cannot be left floating as it could cause an indeterminate state on the output.

For the MIC94325 adjustable part, the turn-on time is affected by the selection of the external feedback resistors and feed-forward capacitor. The relationship is approximately  $2.2 \times R2 \times Cff$ , where R2 is the bottom resistor (connected from ADJ to GND) and Cff is the capacitor connected across R1 (from VOUT to ADJ). For stability, the feed-forward capacitor must be greater than 1nF. 10nF is recommended for best performance.

When disabled, the MIC94355 switches a 50 $\Omega$  (typical) load on the regulator output to discharge the external capacitors.

### Adjustable Regulator Application

The MIC94325 output voltage can be adjusted by using two external resistors (Figure 1). The resistors set the output voltage based on the following equation:

$$V_{OUT} = V_{ADJ} \left( 1 + \frac{R1}{R2} \right)$$

$$V_{ADJ} = 1.1V$$

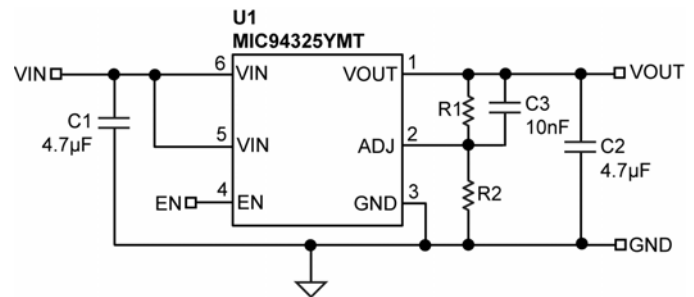

Figure 1. Adjustable Output Voltage

### Thermal Considerations

The MIC943x5 is designed to provide 500mA of continuous current in a very-small package. Maximum ambient operating temperature can be calculated based on the output current and the voltage drop across the part. For example if the input voltage is 2.5V, the output voltage is 1.8V, and the output current = 500mA. The actual power dissipation of the Ripple Blocker™ can be determined using the equation:

$$P_D = (V_{IN} - V_{OUT1}) I_{OUT} + V_{IN} I_{GND}$$

Because this device is CMOS and the ground current is typically  $<170\mu\text{A}$  over the load range, the power dissipation contributed by the ground current is  $<1\%$  and can be ignored for this calculation.

$$P_D = (2.5\text{V} - 1.8\text{V}) \times 500\text{mA}$$

$$P_D = 0.35\text{W}$$

To determine the maximum ambient operating temperature of the package, use the junction-to-ambient thermal resistance of the device and the following basic equation:

$$P_{D(\text{MAX})} = \left( \frac{T_{J(\text{max})} - T_A}{\theta_{JA}} \right)$$

$T_{J(\text{max})} = 125^\circ\text{C}$ , the maximum junction temperature of the die,  $\theta_{JA}$  thermal resistance =  $160^\circ\text{C/W}$  for the YCS package and  $92^\circ\text{C/W}$  for the Thin DFN package.

Substituting  $P_D$  for  $P_{D(\text{MAX})}$  and solving for the ambient operating temperature will give the maximum operating conditions for the regulator circuit.

The maximum power dissipation must not be exceeded for proper operation.

For example, when operating the MIC94325-GYMT at an input voltage of 2.5V and 500mA load with a minimum footprint layout, the maximum ambient operating temperature  $T_A$  can be determined as follows:

$$0.35\text{W} = (125^\circ\text{C} - T_A)/(92^\circ\text{C/W})$$

$$T_A = 92^\circ\text{C}$$

Therefore, the maximum ambient operating temperature allowed in a 1.6mm x 1.6mm Thin DFN package is  $92^\circ\text{C}$ . For a full discussion of heat sinking and thermal effects on voltage regulators, refer to the "Regulator Thermals" section of *Micrel's Designing with Low-Dropout Voltage Regulators* handbook. This information can be found on Micrel's website at:

[http://www.micrel.com/\\_PDF/other/LDOBk.pdf](http://www.micrel.com/_PDF/other/LDOBk.pdf)

[http://www.micrel.com/\\_PDF/other/LDO%20SG.B.pdf](http://www.micrel.com/_PDF/other/LDO%20SG.B.pdf)

For more information about Micrel's Ripple Blocker products, go to:

<http://www.micrel.com/index.php/en/products/power-management-ics/ldos/linear-power-filters.html>

<http://www.micrel.com/index.php/en/products/power-management-ics/ldos/linear-power-filters/article/1-mic94300.html>

<http://www.micrel.com/index.php/en/products/power-management-ics/ldos/linear-power-filters/article/3-mic94310.html>

## Typical Application Schematic (Adjustable Output)

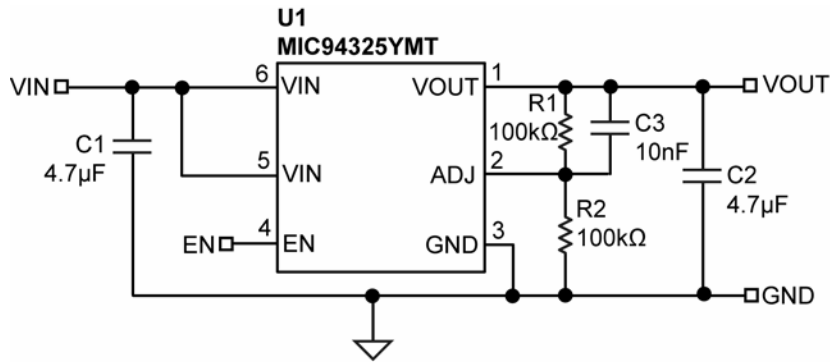

### Bill of Materials

Item	Part Number	Manufacturer	Description	Qty.
C <sub>IN</sub> , C <sub>OUT</sub>	CL10A475K08NNNC	Samsung <sup>(1)</sup>	Capacitor, 4.7µF Ceramic, 16V, X5R, Size 0603	2
C <sub>FF</sub>	C1608X7R2AP/NK	TDK <sup>(2)</sup>	Capacitor, 10nF Ceramic, 50V, X7R, Size 0603	1
R1, R2	CRCW0402100KFKED	Vishay <sup>(3)</sup>	Resistor, 100kΩ, Size 0603	2
U1	MIC94325YMT	Micrel, Inc. <sup>(4)</sup>	500mA LDO with Ripple Blocker Technology	1

**Notes:**

1. Samsung: <http://www.semicon.com>.
2. TDK: [www.tdk.com](http://www.tdk.com).
3. Vishay: [www.vishay.com](http://www.vishay.com).
4. Micrel, Inc.: [www.micrel.com](http://www.micrel.com).

### Typical Application Schematic (Fixed Output)

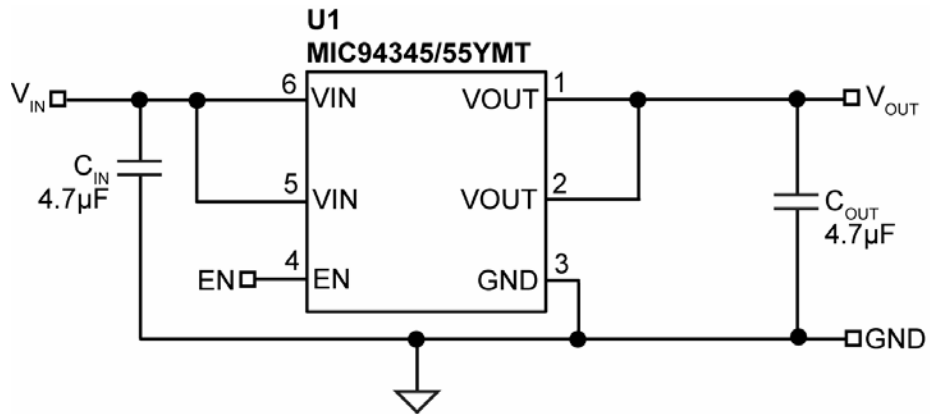

### Bill of Materials

Item	Part Number	Manufacturer	Description	Qty.
$C_{IN}, C_{OUT}$	CL10A475K08NNNC	Samsung <sup>(1)</sup>	Capacitor, 4.7µF Ceramic, 16V, X5R, Size 0603	2
<b>U1</b>	<b>MIC94345-xxYMT</b> <b>MIC94355-xxYMT</b>	<b>Micrel, Inc.</b> <sup>(2)</sup>	<b>500mA LDO with Ripple Blocker Technology</b>	<b>1</b>

**Notes:**

1. Samsung: <http://www.semicon.com/>.
2. Micrel, Inc.: [www.micrel.com](http://www.micrel.com).

**Package Information<sup>(1)</sup>**

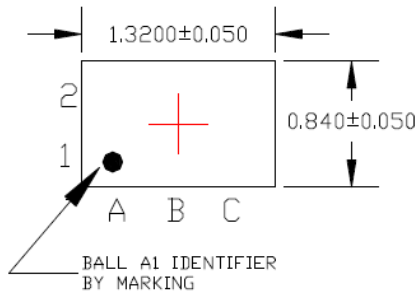

TOP VIEW  
NOTE: 1, 2

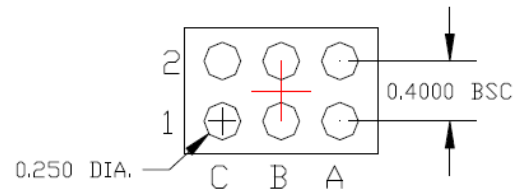

BOTTOM VIEW  
NOTE: 1, 2

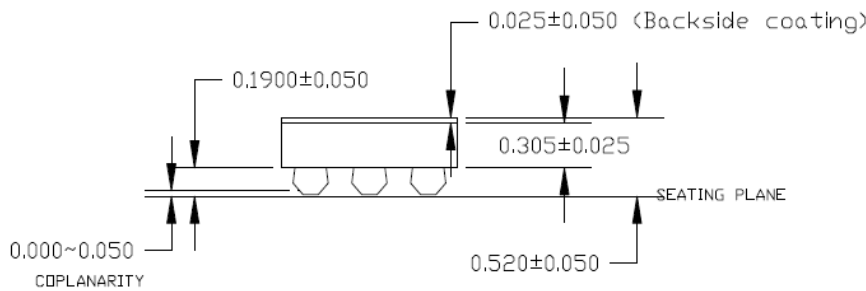

SIDE VIEW  
NOTE: 1, 2

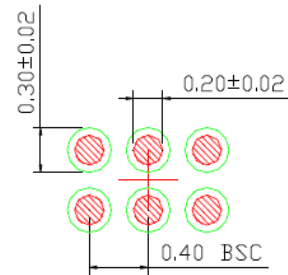

RECOMMENDED LAND PATTERN  
NOTE: 3, 4

**NOTE:**

1. MAX PACKAGE WARPAGE IS 0.05 MM
2. MAX ALLOWABLE BURR IS 0.076MM IN ALL DIRECTIONS
3. NON-SOLDERMASK DEFINED PADS ARE RECOMMENDED FOR BOARD LAYOUT
4. SHADED RED CIRCLES REPRESENT CONTACT PAD AREA, GREEN CIRCLES REPRESENT SOLDER MASK OPENING

**6-Ball 0.84mm × 1.32mm WL-CSP (CS)**

**Note:**

1. Package information is correct as of the publication date. For updates and most current information, go to [www.micrel.com](http://www.micrel.com).

**Package Information<sup>(1)</sup> (Continued)**

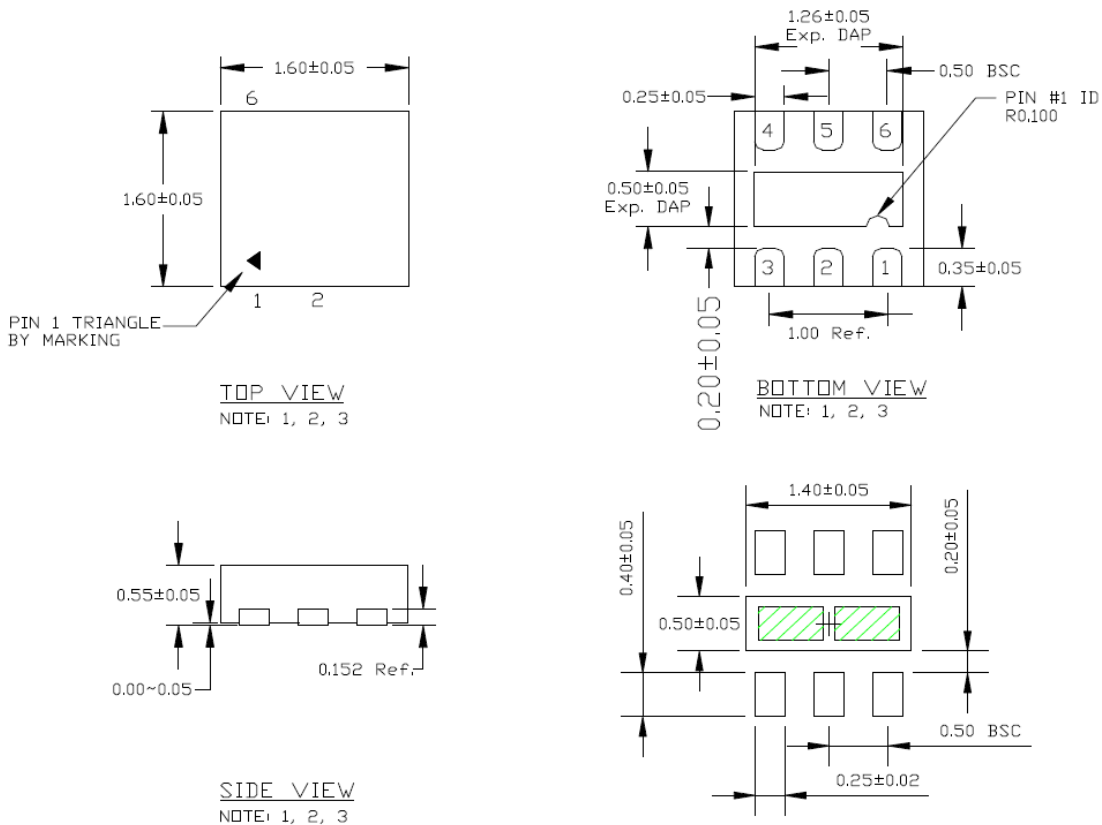

- NOTE:**
1. MAX PACKAGE WARPAGE IS 0.05 MM
  2. MAX ALLOWABLE BURR IS 0.076MM IN ALL DIRECTIONS
  3. PIN #1 IS ON TOP WILL BE LASER MARKED
  4. GREEN SHADED AREA REPRESENT SOLDER STENCIL OPENING (OPTIONAL) FOR IMPROVED THERMAL PERFORMANCE. SIZE: 0.55x0.30MM

**6-Pin 1.6mm x 1.6mm Thin DFN (MT)**

- Note:**
1. Package information is correct as of the publication date. For updates and most current information, go to [www.micrel.com](http://www.micrel.com).

---

**MICREL, INC. 2180 FORTUNE DRIVE SAN JOSE, CA 95131 USA**  
TEL +1 (408) 944-0800 FAX +1 (408) 474-1000 WEB <http://www.micrel.com>

Micrel makes no representations or warranties with respect to the accuracy or completeness of the information furnished in this data sheet. This information is not intended as a warranty and Micrel does not assume responsibility for its use. Micrel reserves the right to change circuitry, specifications and descriptions at any time without notice. No license, whether express, implied, arising by estoppel or otherwise, to any intellectual property rights is granted by this document. Except as provided in Micrel's terms and conditions of sale for such products, Micrel assumes no liability whatsoever, and Micrel disclaims any express or implied warranty relating to the sale and/or use of Micrel products including liability or warranties relating to fitness for a particular purpose, merchantability, or infringement of any patent, copyright or other intellectual property right.

Micrel Products are not designed or authorized for use as components in life support appliances, devices or systems where malfunction of a product can reasonably be expected to result in personal injury. Life support devices or systems are devices or systems that (a) are intended for surgical implant into the body or (b) support or sustain life, and whose failure to perform can be reasonably expected to result in a significant injury to the user. A Purchaser's use or sale of Micrel Products for use in life support appliances, devices or systems is a Purchaser's own risk and Purchaser agrees to fully indemnify Micrel for any damages resulting from such use or sale.

© 2012 Micrel, Incorporated.