

FEATURES

- Qualified for automotive applications
- Low power: 1.3 mA supply current/amplifier
- High speed
 - 125 MHz, -3 dB bandwidth ($G = +1$)
 - 60 V/ μ s slew rate
 - 80 ns settling time to 0.1%
- Rail-to-rail input and output
 - No phase reversal, inputs 200 mV beyond rails
- Wide supply range: 2.7 V to 12 V
- Offset voltage: 6 mV maximum
- Low input bias current
 - +0.7 μ A to -1.5 μ A
- Small packaging
 - SOIC-8, SC70-6, SOT23-8, SOIC-14, TSSOP-14

APPLICATIONS

- Automotive safety and vision systems
- Battery-powered instrumentation
- Filters
- A-to-D drivers
- Buffering

GENERAL DESCRIPTION

The AD8029 (single), AD8030 (dual), and AD8040 (quad) are rail-to-rail input and output high speed amplifiers with a quiescent current of only 1.3 mA per amplifier. Despite their low power consumption, the amplifiers provide excellent performance with 125 MHz small signal bandwidth and 60 V/ μ s slew rate. Analog Devices, Inc., proprietary XFCB process enables high speed and high performance on low power.

This family of amplifiers exhibits true single-supply operation with rail-to-rail input and output performance for supply voltages ranging from 2.7 V to 12 V. The input voltage range extends 200 mV beyond each rail without phase reversal. The dynamic range of the output extends to within 40 mV of each rail.

The AD8029/AD8030/AD8040 provide excellent signal quality with minimal power dissipation. At $G = +1$, SFDR is -72 dBc at 1 MHz and settling time to 0.1% is only 80 ns. Low distortion and fast settling performance make these amplifiers suitable drivers for single-supply analog-to-digital converters.

The versatility of the AD8029/AD8030/AD8040 allows the user to operate the amplifiers on a wide range of supplies while consuming less than 6.5 mW of power. These features extend the operation time in applications ranging from battery-powered systems with large bandwidth requirements to high speed

CONNECTION DIAGRAMS

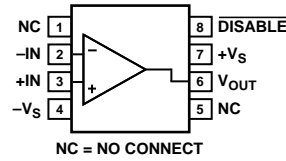

Figure 1. SOIC-8 (R)

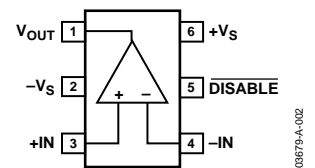

Figure 2. SC70-6 (KS)

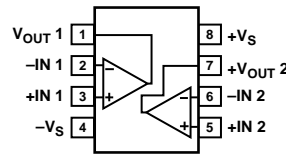

Figure 3. SOIC-8 (R) and SOT23-8 (RJ)

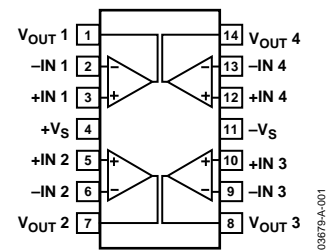

Figure 4. SOIC-14 (R) and TSSOP-14 (RU)

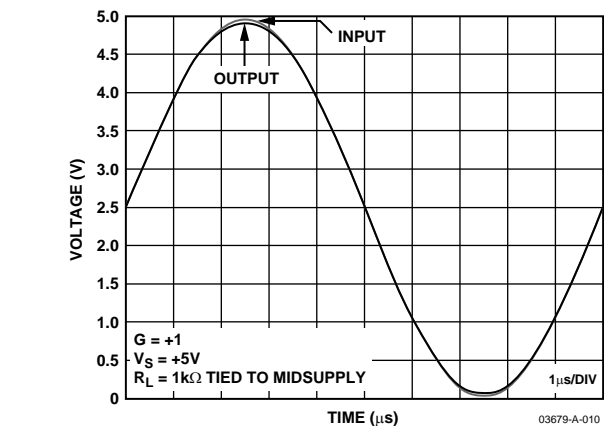

Figure 5. Rail-to-Rail Response

Rev. B

Document Feedback

Information furnished by Analog Devices is believed to be accurate and reliable. However, no responsibility is assumed by Analog Devices for its use, nor for any infringements of patents or other rights of third parties that may result from its use. Specifications subject to change without notice. No license is granted by implication or otherwise under any patent or patent rights of Analog Devices. Trademarks and registered trademarks are the property of their respective owners.

IMPORTANT LINKS for the [AD8029](#) [8030](#) [8040](#)*

Last content update 08/18/2013 10:03 pm

PARAMETRIC SELECTION TABLES

Find Similar Products By Operating Parameters

[High Speed Amplifiers Selection Table](#)

DOCUMENTATION

AN-649: Using the Analog Devices Active Filter Design Tool

AN-581: Biasing and Decoupling Op Amps in Single Supply Applications

AN-402: Replacing Output Clamping Op Amps with Input Clamping Amps

AN-417: Fast Rail-to-Rail Operational Amplifiers Ease Design Constraints in Low Voltage High Speed Systems

MT-060: Choosing Between Voltage Feedback and Current Feedback Op Amps

MT-059: Compensating for the Effects of Input Capacitance on VFB and CFB Op Amps Used in Current-to-Voltage Converters

MT-058: Effects of Feedback Capacitance on VFB and CFB Op Amps

MT-056: High Speed Voltage Feedback Op Amps

MT-053: Op Amp Distortion: HD, THD, THD + N, IMD, SFDR, MTPR

MT-052: Op Amp Noise Figure: Don't Be Mislead

MT-050: Op Amp Total Output Noise Calculations for Second-Order System

MT-049: Op Amp Total Output Noise Calculations for Single-Pole System

MT-048: Op Amp Noise Relationships: 1/f Noise, RMS Noise, and Equivalent Noise Bandwidth

MT-047: Op Amp Noise

MT-033: Voltage Feedback Op Amp Gain and Bandwidth

MT-032: Ideal Voltage Feedback (VFB) Op Amp

A Stress-Free Method for Choosing High-Speed Op Amps

FOR THE AD8029

UG-112: Universal Evaluation Board for Single, High Speed Op Amps Offered in SC-70 Packages

UG-101: Evaluation Board User Guide

FOR THE AD8030

UG-019: Universal Evaluation Board for Dual, High Speed Op Amps Offered in 8-Lead SOT-23 Packages

UG-128: Universal Evaluation Board for Dual High Speed Op Amps in SOIC Packages

FOR THE AD8040

UG-111: Universal Evaluation Board for Quad, High Speed Op Amps Offered in 14-Lead SOIC Packages

UG-020: Universal Evaluation Board for Quad High Speed Op Amps Offered in 14-Lead TSSOP Packages

DESIGN TOOLS, MODELS, DRIVERS & SOFTWARE

[dBm/dBu/dBv Calculator](#)

[Analog Filter Wizard 2.0](#)

[Power Dissipation vs Die Temp](#)

ADIsimOpAmp™

[OpAmp Stability](#)

[AD8029 SPICE Macro Model](#)

[AD8030 SPICE Macro Model](#)

[AD8040 SPICE Macro Model](#)

EVALUATION KITS & SYMBOLS & FOOTPRINTS

[View the Evaluation Boards and Kits page for the AD8029](#)

[View the Evaluation Boards and Kits page for the AD8030](#)

[View the Evaluation Boards and Kits page for the AD8040](#)

[Symbols and Footprints for the AD8029](#)

[Symbols and Footprints for the AD8030](#)

[Symbols and Footprints for the AD8040](#)

DESIGN SUPPORT

Submit your support request here:

[Linear and Data Converters](#)

[Embedded Processing and DSP](#)

Telephone our Customer Interaction Centers toll free:

| | |
|-----------|------------------|
| Americas: | 1-800-262-5643 |
| Europe: | 00800-266-822-82 |
| China: | 4006-100-006 |
| India: | 1800-419-0108 |
| Russia: | 8-800-555-45-90 |

[Quality and Reliability](#)

[Lead\(Pb\)-Free Data](#)

SAMPLE & BUY

AD8029

AD8030

AD8040

- [View Price & Packaging](#)
- [Request Evaluation Board](#)
- [Request Samples Check Inventory & Purchase](#)

[Find Local Distributors](#)

* This page was dynamically generated by Analog Devices, Inc. and inserted into this data sheet.
Note: Dynamic changes to the content on this page (labeled 'Important Links') does not constitute a change to the revision number of the product data sheet.
This content may be frequently modified.

TABLE OF CONTENTS

| | | | |
|---|---|--|----|
| Features | 1 | Theory of Operation | 16 |
| Applications..... | 1 | Input Stage..... | 16 |
| Connection Diagrams..... | 1 | Output Stage..... | 16 |
| General Description | 1 | Applications..... | 17 |
| Specifications..... | 3 | Wideband Operation | 17 |
| Specifications with ± 5 V Supply..... | 3 | Output Loading Sensitivity | 17 |
| Specifications with +5 V Supply..... | 4 | Disable Pin | 18 |
| Specifications with +3 V Supply..... | 5 | Circuit Considerations | 19 |
| Absolute Maximum Ratings..... | 7 | Design Tools and Technical Support | 19 |
| Maximum Power Dissipation | 7 | Outline Dimensions | 20 |
| ESD Caution..... | 7 | Ordering Guide | 21 |
| Typical Performance Characteristics | 8 | | |

REVISION HISTORY

10/12—Rev. A to Rev. B

| | |
|--|-----------|
| Added Automotive Model, AD8040W | Universal |
| Changes to Features Section..... | 1 |
| Changes to General Description Section | 1 |
| Changes to Specifications Section, Table 1, Added Automotive Specifications..... | 3 |
| Moved ESD Caution to Absolute Maximum Ratings Section.... | 7 |
| Changes to Figure 17..... | 9 |
| Updated Outline Dimensions | 20 |
| Changes to Ordering Guide | 21 |

11/03—Rev. 0 to Rev. A

| | |
|---|-----------|
| Added AD8040 part | Universal |
| Change to Figure 5 | 1 |
| Changes to Specifications | 3 |
| Changes to Figures 10–12..... | 7 |
| Change to Figure 14 | 8 |
| Changes to Figures 20 and 21 | 9 |
| Inserted new Figure 36..... | 11 |
| Change to Figure 40 | 12 |
| Inserted new Figure 41..... | 12 |
| Added Output Loading Sensitivity section | 16 |
| Changes to Table 5..... | 17 |
| Changes to Power Supply Bypassing section | 18 |
| Changes to Ordering Guide | 20 |

SPECIFICATIONS

SPECIFICATIONS WITH ± 5 V SUPPLYTable 1. $V_S = \pm 5$ V @ $T_A = 25^\circ\text{C}$, $G = +1$, $R_L = 1$ k Ω to ground, unless otherwise noted. All specifications are per amplifier.

| Parameter | Conditions | Min | Typ | Max | Unit |
|---|--|---------------|--------------|---------------|------------------------------|
| DYNAMIC PERFORMANCE | | | | | |
| -3 dB Bandwidth | $G = +1$, $V_O = 0.1$ V p-p | 80 | 125 | | MHz |
| | AD8040W only: T_{MIN} to T_{MAX} | 80 | | | MHz |
| | $G = +1$, $V_O = 2$ V p-p | 14 | 19 | | MHz |
| | AD8040W only: T_{MIN} to T_{MAX} | 9 | | | MHz |
| Bandwidth for 0.1 dB Flatness | $G = +2$, $V_O = 0.1$ V p-p | | 6 | | MHz |
| Slew Rate | $G = +1$, $V_O = 2$ V Step | | 62 | | V/ μ s |
| | $G = -1$, $V_O = 2$ V Step | | 63 | | V/ μ s |
| Settling Time to 0.1% | $G = +2$, $V_O = 2$ V Step | | 80 | | ns |
| NOISE/DISTORTION PERFORMANCE | | | | | |
| Spurious Free Dynamic Range (SFDR) | $f_c = 1$ MHz, $V_O = 2$ V p-p | | -74 | | dBc |
| | $f_c = 5$ MHz, $V_O = 2$ V p-p | | -56 | | dBc |
| Input Voltage Noise | $f = 100$ kHz | | 16.5 | | nV/ $\sqrt{\text{Hz}}$ |
| Input Current Noise | $f = 100$ kHz | | 1.1 | | pA/ $\sqrt{\text{Hz}}$ |
| Crosstalk (AD8030/AD8040) | $f = 5$ MHz, $V_{IN} = 2$ V p-p | | -79 | | dB |
| DC PERFORMANCE | | | | | |
| Input Offset Voltage | PNP Active, $V_{CM} = 0$ V | | 1.6 | 5 | mV |
| | AD8040W only: T_{MIN} to T_{MAX} | | | 9.5 | mV |
| | NPN Active, $V_{CM} = 4.5$ V | | 2 | 6 | mV |
| | AD8040W only: T_{MIN} to T_{MAX} | | | 9.5 | mV |
| Input Offset Voltage Drift | T_{MIN} to T_{MAX} | | 30 | | $\mu\text{V}/^\circ\text{C}$ |
| Input Bias Current ¹ | NPN Active, $V_{CM} = 4.5$ V | | 0.7 | 1.3 | μ A |
| | T_{MIN} to T_{MAX} | | 1 | | μ A |
| | AD8040W only: T_{MIN} to T_{MAX} | | | 1.3 | μ A |
| | PNP Active, $V_{CM} = 0$ V | | -1.7 | -2.8 | μ A |
| | T_{MIN} to T_{MAX} | | 2 | | μ A |
| | AD8040W only: T_{MIN} to T_{MAX} | | | -2.8 | μ A |
| Input Offset Current | | | ± 0.1 | ± 0.9 | μ A |
| | AD8040W only: T_{MIN} to T_{MAX} | | | ± 0.9 | μ A |
| Open-Loop Gain | $V_O = \pm 4.0$ V | 65 | 74 | | dB |
| | AD8040W only: T_{MIN} to T_{MAX} | 62 | | | dB |
| INPUT CHARACTERISTICS | | | | | |
| Input Resistance | | | 6 | | M Ω |
| Input Capacitance | | | 2 | | pF |
| Input Common-Mode Voltage Range | | | -5.2 to +5.2 | | V |
| Common-Mode Rejection Ratio | $V_{CM} = -4.5$ V to +3 V, $R_L = 10$ k Ω | 80 | 90 | | dB |
| | AD8040W only: T_{MIN} to T_{MAX} | 80 | | | dB |
| DISABLE PIN (AD8029) | | | | | |
| $\overline{\text{DISABLE}}$ Low Voltage | | | $-V_S + 0.8$ | | V |
| $\overline{\text{DISABLE}}$ Low Current | | | -6.5 | | μ A |
| $\overline{\text{DISABLE}}$ High Voltage | | | $-V_S + 1.2$ | | V |
| $\overline{\text{DISABLE}}$ High Current | | | 0.2 | | μ A |
| Turn-Off Time | 50% of $\overline{\text{DISABLE}}$ to <10% of Final V_O , $V_{IN} = -1$ V, $G = -1$ | | 150 | | ns |
| Turn-On Time | 50% of $\overline{\text{DISABLE}}$ to <10% of Final V_O , $V_{IN} = -1$ V, $G = -1$ | | 85 | | ns |
| OUTPUT CHARACTERISTICS | | | | | |
| Output Overdrive Recovery Time (Rising/Falling Edge) | $V_{IN} = +6$ V to -6 V, $G = -1$ | | 55/45 | | ns |
| | $R_L = 1$ k Ω | | | | |
| Output Voltage Swing | | $-V_S + 0.22$ | | $+V_S - 0.22$ | V |
| | AD8040W only: T_{MIN} to T_{MAX} | $-V_S + 0.22$ | | $+V_S - 0.22$ | V |
| | $R_L = 10$ k Ω | $-V_S + 0.05$ | | $+V_S - 0.05$ | V |
| | AD8040W only: T_{MIN} to T_{MAX} | $-V_S + 0.05$ | | $+V_S - 0.05$ | V |

| Parameter | Conditions | Min | Typ | Max | Unit |
|------------------------------|--|-----|---------|------|------|
| Short-Circuit Current | Sinking and Sourcing | | 170/160 | | mA |
| Off Isolation (AD8029) | $V_{IN} = 0.1 \text{ V p-p}$, $f = 1 \text{ MHz}$, $\overline{\text{DISABLE}} = \text{Low}$ | | -55 | | dB |
| Capacitive Load Drive | 30% Overshoot | | 20 | | pF |
| POWER SUPPLY | | | | | |
| Operating Range | | 2.7 | | 12 | V |
| Quiescent Current/Amplifier | | | 1.4 | 1.5 | mA |
| Quiescent Current (Disabled) | AD8040W only: T_{MIN} to T_{MAX} $\overline{\text{DISABLE}} = \text{Low}$, AD8029 only | | | 1.85 | mA |
| Power Supply Rejection Ratio | $V_S \pm 1 \text{ V}$ | 73 | 80 | 200 | dB |
| | AD8040W only: T_{MIN} to T_{MAX} | 72 | | | dB |

¹ Plus, +, (or no sign) indicates current into pin; minus (-) indicates current out of pin.

SPECIFICATIONS WITH +5 V SUPPLY

Table 2. $V_S = 5 \text{ V}$ @ $T_A = 25^\circ\text{C}$, $G = +1$, $R_L = 1 \text{ k}\Omega$ to midsupply, unless otherwise noted. All specifications are per amplifier.

| Parameter | Conditions | Min | Typ | Max | Unit |
|--|--|-------------------------------------|--------------|-----------|------------------------------|
| DYNAMIC PERFORMANCE | | | | | |
| -3 dB Bandwidth | $G = +1$, $V_O = 0.1 \text{ V p-p}$ | 80 | 120 | | MHz |
| | AD8040W only: T_{MIN} to T_{MAX} | 80 | | | MHz |
| | $G = +1$, $V_O = 2 \text{ V p-p}$ | 13 | 18 | | MHz |
| | AD8040W only: T_{MIN} to T_{MAX} | 8 | | | MHz |
| Bandwidth for 0.1 dB Flatness | $G = +2$, $V_O = 0.1 \text{ V p-p}$ | | 6 | | MHz |
| Slew Rate | $G = +1$, $V_O = 2 \text{ V Step}$ | | 55 | | V/ μs |
| | $G = -1$, $V_O = 2 \text{ V Step}$ | | 60 | | V/ μs |
| Settling Time to 0.1% | $G = +2$, $V_O = 2 \text{ V Step}$ | | 82 | | ns |
| NOISE/DISTORTION PERFORMANCE | | | | | |
| Spurious Free Dynamic Range (SFDR) | $f_c = 1 \text{ MHz}$, $V_O = 2 \text{ V p-p}$ | | -73 | | dBc |
| | $f_c = 5 \text{ MHz}$, $V_O = 2 \text{ V p-p}$ | | -55 | | dBc |
| Input Voltage Noise | $f = 100 \text{ kHz}$ | | 16.5 | | nV/ $\sqrt{\text{Hz}}$ |
| Input Current Noise | $f = 100 \text{ kHz}$ | | 1.1 | | pA/ $\sqrt{\text{Hz}}$ |
| Crosstalk (AD8030/AD8040) | $f = 5 \text{ MHz}$, $V_{IN} = 2 \text{ V p-p}$ | | -79 | | dB |
| DC PERFORMANCE | | | | | |
| Input Offset Voltage | PNP Active, $V_{CM} = 2.5 \text{ V}$ | | 1.4 | 5 | mV |
| | AD8040W only: T_{MIN} to T_{MAX} | | | 8.5 | mV |
| | NPN Active, $V_{CM} = 4.5 \text{ V}$ | | 1.8 | 6 | mV |
| | AD8040W only: T_{MIN} to T_{MAX} | | | 8.5 | mV |
| Input Offset Voltage Drift | T_{MIN} to T_{MAX} | | 25 | | $\mu\text{V}/^\circ\text{C}$ |
| Input Bias Current ¹ | NPN Active, $V_{CM} = 4.5 \text{ V}$ | | 0.8 | 1.2 | μA |
| | T_{MIN} to T_{MAX} | | 1 | | μA |
| | PNP Active, $V_{CM} = 2.5 \text{ V}$ | | -1.8 | -2.8 | μA |
| | T_{MIN} to T_{MAX} | | 2 | | μA |
| Input Offset Current | | | ± 0.1 | ± 0.9 | μA |
| | AD8040W only: T_{MIN} to T_{MAX} | | | ± 0.9 | μA |
| | Open-Loop Gain | $V_O = 1 \text{ V to } 4 \text{ V}$ | 65 | 74 | dB |
| | AD8040W only: T_{MIN} to T_{MAX} | 62 | | | dB |
| INPUT CHARACTERISTICS | | | | | |
| Input Resistance | | | 6 | | M Ω |
| Input Capacitance | | | 2 | | pF |
| Input Common-Mode Voltage Range | | | -0.2 to +5.2 | | V |
| Common-Mode Rejection Ratio | $V_{CM} = 0.25 \text{ V to } 2 \text{ V}$, $R_L = 10 \text{ k}\Omega$ | 80 | 90 | | dB |
| | AD8040W only: T_{MIN} to T_{MAX} | 80 | | | dB |
| DISABLE PIN (AD8029) | | | | | |
| $\overline{\text{DISABLE}}$ Low Voltage | | | $-V_S + 0.8$ | | V |
| $\overline{\text{DISABLE}}$ Low Current | | | -6.5 | | μA |
| $\overline{\text{DISABLE}}$ High Voltage | | | $-V_S + 1.2$ | | V |

| Parameter | Conditions | Min | Typ | Max | Unit |
|---|--|---------------|-------|---------------|---------------|
| DISABLE High Current Turn-Off Time | 50% of $\overline{\text{DISABLE}}$ to <10% of Final V_O , $V_{IN} = -1\text{ V}$, $G = -1$ | | 0.2 | | μA |
| Turn-On Time | 50% of $\overline{\text{DISABLE}}$ to <10% of Final V_O , $V_{IN} = -1\text{ V}$, $G = -1$ | | 155 | | ns |
| OUTPUT CHARACTERISTICS | | | | | |
| Overdrive Recovery Time (Rising/Falling Edge) | $V_{IN} = -1\text{ V}$ to $+6\text{ V}$, $G = -1$ | | 45/50 | | ns |
| Output Voltage Swing | $R_L = 1\text{ k}\Omega$ AD8040W only: T_{MIN} to T_{MAX} | $-V_S + 0.17$ | | $+V_S - 0.17$ | V |
| | $R_L = 10\text{ k}\Omega$ AD8040W only: T_{MIN} to T_{MAX} | $-V_S + 0.17$ | | $+V_S - 0.17$ | V |
| | | $-V_S + 0.04$ | | $+V_S - 0.04$ | V |
| | | $-V_S + 0.04$ | | $+V_S - 0.04$ | V |
| Short-Circuit Current | Sinking and Sourcing | | 95/60 | | mA |
| Off Isolation (AD8029) | $V_{in} = 0.1\text{ V p-p}$, $f = 1\text{ MHz}$, $\overline{\text{DISABLE}} = \text{Low}$ | | -55 | | dB |
| Capacitive Load Drive | 30% Overshoot | | 15 | | pF |
| POWER SUPPLY | | | | | |
| Operating Range | | 2.7 | | 12 | V |
| Quiescent Current/Amplifier | | | 1.3 | 1.5 | mA |
| | AD8040W only: T_{MIN} to T_{MAX} | | | 1.75 | mA |
| Quiescent Current (Disabled) | $\overline{\text{DISABLE}} = \text{Low}$, AD8029 only | | 140 | 200 | μA |
| Power Supply Rejection Ratio | $V_S \pm 1\text{ V}$ | 73 | 80 | | dB |
| | AD8040W only: T_{MIN} to T_{MAX} | 72 | | | dB |

¹ Plus, +, (or no sign) indicates current into pin; minus (-) indicates current out of pin.

SPECIFICATIONS WITH +3 V SUPPLY

Table 3. $V_S = +3\text{ V}$ @ $T_A = 25^\circ\text{C}$, $G = +1$, $R_L = 1\text{ k}\Omega$ to midsupply, unless otherwise noted. All specifications are per amplifier.

| Parameter | Conditions | Min | Typ | Max | Unit |
|------------------------------------|---|-----|-----------|-----------|------------------------------|
| DYNAMIC PERFORMANCE | | | | | |
| -3 dB Bandwidth | $G = +1$, $V_O = 0.1\text{ V p-p}$ AD8040W only: T_{MIN} to T_{MAX} | 80 | 112 | | MHz |
| | $G = +1$, $V_O = 2\text{ V p-p}$ AD8040W only: T_{MIN} to T_{MAX} | 80 | 18 | | MHz |
| Bandwidth for 0.1 dB Flatness | $G = +2$, $V_O = 0.1\text{ V p-p}$ | 13 | 6 | | MHz |
| Slew Rate | $G = +1$, $V_O = 2\text{ V Step}$ | 8 | 55 | | V/ μs |
| | $G = -1$, $V_O = 2\text{ V Step}$ | | 57 | | V/ μs |
| Settling Time to 0.1% | $G = +2$, $V_O = 2\text{ V Step}$ | | 110 | | ns |
| NOISE/DISTORTION PERFORMANCE | | | | | |
| Spurious Free Dynamic Range (SFDR) | $f_c = 1\text{ MHz}$, $V_O = 2\text{ V p-p}$ | | -72 | | dBc |
| | $f_c = 5\text{ MHz}$, $V_O = 2\text{ V p-p}$ | | -60 | | dBc |
| Input Voltage Noise | $f = 100\text{ kHz}$ | | 16.5 | | nV/ $\sqrt{\text{Hz}}$ |
| Input Current Noise | $f = 100\text{ kHz}$ | | 1.1 | | pA/ $\sqrt{\text{Hz}}$ |
| Crosstalk (AD8030/AD8040) | $f = 5\text{ MHz}$, $V_{IN} = 2\text{ V p-p}$ | | -80 | | dB |
| DC PERFORMANCE | | | | | |
| Input Offset Voltage | PNP Active, $V_{CM} = 1.5\text{ V}$ AD8040W only: T_{MIN} to T_{MAX} | | 1.1 | 5 | mV |
| | NPN Active, $V_{CM} = 2.5\text{ V}$ AD8040W only: T_{MIN} to T_{MAX} | | 1.6 | 6 | mV |
| | | | | 8 | mV |
| Input Offset Voltage Drift | T_{MIN} to T_{MAX} | | 24 | | $\mu\text{V}/^\circ\text{C}$ |
| Input Bias Current ¹ | NPN Active, $V_{CM} = 2.5\text{ V}$ | | 0.7 | 1.2 | μA |
| | T_{MIN} to T_{MAX} | | 1 | | μA |
| Input Bias Current ¹ | PNP Active, $V_{CM} = 1.5\text{ V}$ | | -1.5 | -2.5 | μA |
| | T_{MIN} to T_{MAX} | | 1.6 | | μA |
| Input Offset Current | | | ± 0.1 | ± 0.9 | μA |
| | AD8040W only: T_{MIN} to T_{MAX} | | | ± 0.9 | μA |

| Parameter | Conditions | Min | Typ | Max | Unit |
|---|---|--|--------------|--|------------------|
| Open-Loop Gain | $V_o = 0.5\text{ V to }2.5\text{ V}$ AD8040W only: T_{MIN} to T_{MAX} | 64 62 | 73 | | dB dB |
| INPUT CHARACTERISTICS | | | | | |
| Input Resistance | | | 6 | | $M\Omega$ |
| Input Capacitance | | | 2 | | pF |
| Input Common-Mode Voltage Range | | | -0.2 to +3.2 | | V |
| Common-Mode Rejection Ratio | $V_{\text{CM}} = 0.25\text{ V to }1.25\text{ V}$, $R_L = 10\text{ k}\Omega$ AD8040W only: T_{MIN} to T_{MAX} | 78 78 | 88 | | dB dB |
| DISABLE PIN (AD8029) | | | | | |
| $\overline{\text{DISABLE}}$ Low Voltage | | | $-V_S + 0.8$ | | V |
| $\overline{\text{DISABLE}}$ Low Current | | | -6.5 | | μA |
| $\overline{\text{DISABLE}}$ High Voltage | | | $-V_S + 1.2$ | | V |
| $\overline{\text{DISABLE}}$ High Current | | | 0.2 | | μA |
| Turn-Off Time | 50% of $\overline{\text{DISABLE}}$ to <10% of Final V_o , $V_{\text{IN}} = -1\text{ V}$, $G = -1$ | | 165 | | ns |
| Turn-On Time | 50% of $\overline{\text{DISABLE}}$ to <10% of Final V_o , $V_{\text{IN}} = -1\text{ V}$, $G = -1$ | | 95 | | ns |
| OUTPUT CHARACTERISTICS | | | | | |
| Output Overdrive Recovery Time (Rising/Falling Edge) | $V_{\text{IN}} = -1\text{ V to }+4\text{ V}$, $G = -1$ $R_L = 1\text{ k}\Omega$ AD8040W only: T_{MIN} to T_{MAX} | | 75/100 | | ns |
| Output Voltage Swing | $R_L = 10\text{ k}\Omega$ AD8040W only: T_{MIN} to T_{MAX} | $-V_S + 0.09$ $-V_S + 0.09$ $-V_S + 0.04$ $-V_S + 0.04$ | | $+V_S - 0.09$ $+V_S - 0.09$ $+V_S - 0.04$ $+V_S - 0.04$ | V V V V |
| Short-Circuit Current Off Isolation (AD8029) | Sinking and Sourcing $V_{\text{IN}} = 0.1\text{ V p-p}$, $f = 1\text{ MHz}$, $\overline{\text{DISABLE}} = \text{Low}$ | | 80/40 | | mA dB |
| Capacitive Load Drive | 30% Overshoot | | 10 | | pF |
| POWER SUPPLY | | | | | |
| Operating Range | | 2.7 | | 12 | V |
| Quiescent Current/Amplifier | | | 1.3 | 1.4 | mA |
| Quiescent Current (Disabled) | AD8040W only: T_{MIN} to T_{MAX} $\overline{\text{DISABLE}} = \text{Low}$, AD8029 only | | | 1.75 | mA |
| Power Supply Rejection Ratio | $V_S \pm 1\text{ V}$ AD8040W only: T_{MIN} to T_{MAX} | 70 68 | 76 | 200 | dB dB |

¹ Plus, +, (or no sign) indicates current into pin; minus (-) indicates current out of pin.

ABSOLUTE MAXIMUM RATINGS

Table 4. AD8029/AD8030/AD8040 Stress Ratings

| Parameter | Rating |
|--|---------------------|
| Supply Voltage | 12.6 V |
| Power Dissipation | See Figure 6 |
| Common-Mode Input Voltage | $\pm V_S \pm 0.5$ V |
| Differential Input Voltage | ± 1.8 V |
| Storage Temperature | -65°C to +125°C |
| Operating Temperature Range | -40°C to +125°C |
| Lead Temperature Range (Soldering 10 sec) | 300°C |
| Junction Temperature | 150°C |

Stresses above those listed under Absolute Maximum Ratings may cause permanent damage to the device. This is a stress rating only; functional operation of the device at these or any other conditions above those indicated in the operational section of this specification is not implied. Exposure to absolute maximum rating conditions for extended periods may affect device reliability.

MAXIMUM POWER DISSIPATION

The maximum safe power dissipation in the AD8029/AD8030/AD8040 package is limited by the associated rise in junction temperature (T_J) on the die. The plastic encapsulating the die locally reaches the junction temperature. At approximately 150°C, which is the glass transition temperature, the plastic changes its properties. Even temporarily exceeding this temperature limit may change the stresses that the package exerts on the die, permanently shifting the parametric performance of the AD8029/AD8030/AD8040. Exceeding a junction temperature of 175°C for an extended period can result in changes in silicon devices, potentially causing failure.

The still-air thermal properties of the package and PCB (θ_{JA}), ambient temperature (T_A), and the total power dissipated in the package (P_D) determine the junction temperature of the die. The junction temperature can be calculated as

$$T_J = T_A + (P_D \times \theta_{JA})$$

The power dissipated in the package (P_D) is the sum of the quiescent power dissipation and the power dissipated in the package due to the load drive for all outputs. The quiescent power is the voltage between the supply pins (V_S) times the quiescent current (I_S). Assuming the load (R_L) is referenced to midsupply, the total drive power is $V_S/2 \times I_{OUT}$, some of which is dissipated in the package and some in the load ($V_{OUT} \times I_{OUT}$). The difference between the total drive power and the load power is the drive power dissipated in the package.

$$P_D = \text{Quiescent Power} + (\text{Total Drive Power} - \text{Load Power})$$

$$P_D = (V_S \times I_S) + \left(\frac{V_S}{2} \times \frac{V_{OUT}}{R_L} \right) - \frac{V_{OUT}^2}{R_L}$$

RMS output voltages should be considered. If R_L is referenced to V_S- , as in single-supply operation, then the total drive power is $V_S \times I_{OUT}$.

If the rms signal levels are indeterminate, consider the worst case, when $V_{OUT} = V_S/4$ for R_L to midsupply:

$$P_D = (V_S \times I_S) + \frac{(V_S/4)^2}{R_L}$$

In single-supply operation with R_L referenced to V_S- , worst case is $V_{OUT} = V_S/2$.

Airflow increases heat dissipation, effectively reducing θ_{JA} . Also, more metal directly in contact with the package leads from metal traces, through holes, ground, and power planes reduce the θ_{JA} . Care must be taken to minimize parasitic capacitances at the input leads of high speed op amps, as discussed in the PCB Layout section.

Figure 6 shows the maximum safe power dissipation in the package versus the ambient temperature for the SOIC-8 (125°C/W), SOT23-8 (160°C/W), SOIC-14 (90°C/W), TSSOP-14 (120°C/W), and SC70-6 (208°C/W) packages on a JEDEC standard 4-layer board. θ_{JA} values are approximations.

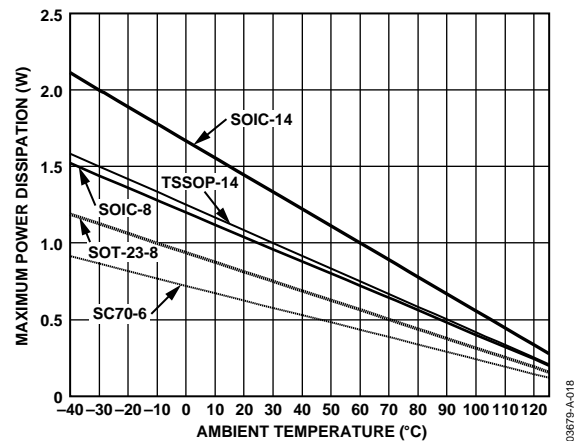

Figure 6. Maximum Power Dissipation

Output Short Circuit

Shorting the output to ground or drawing excessive current from the AD8029/AD8030/AD8040 could cause catastrophic failure.

ESD CAUTION



ESD (electrostatic discharge) sensitive device.

Charged devices and circuit boards can discharge without detection. Although this product features patented or proprietary protection circuitry, damage may occur on devices subjected to high energy ESD. Therefore, proper ESD precautions should be taken to avoid performance degradation or loss of functionality.

TYPICAL PERFORMANCE CHARACTERISTICS

Default Conditions: $V_S = 5\text{ V}$ ($T_A = 25^\circ\text{C}$, $R_L = 1\text{ k}\Omega$ tied to midsupply, unless otherwise noted.)

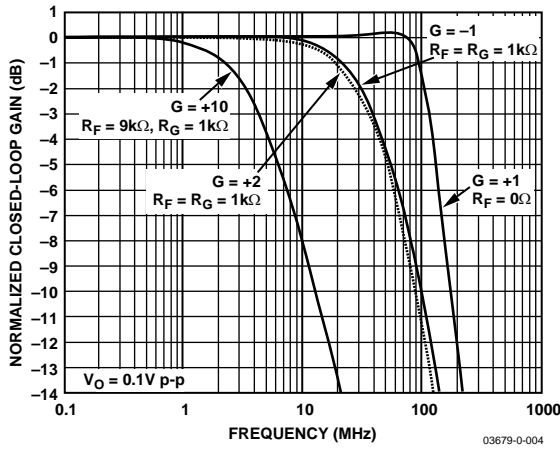

Figure 7. Small Signal Frequency Response for Various Gains

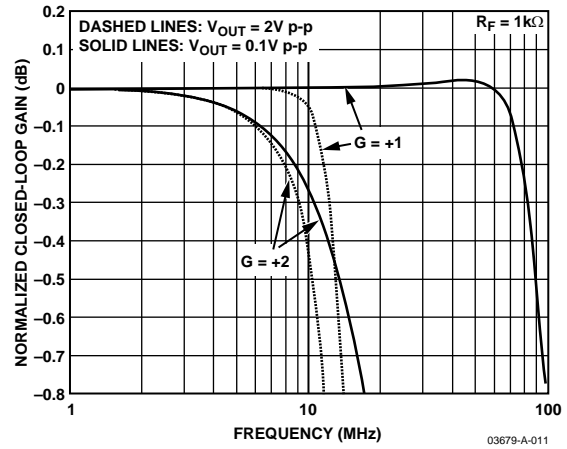

Figure 10. 0.1 dB Flatness Frequency Response

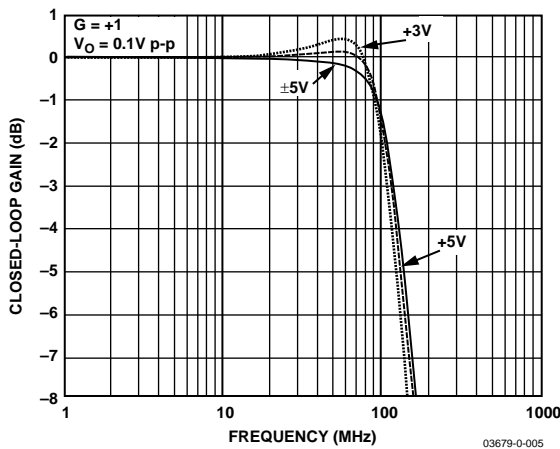

Figure 8. Small Signal Frequency Response for Various Supplies

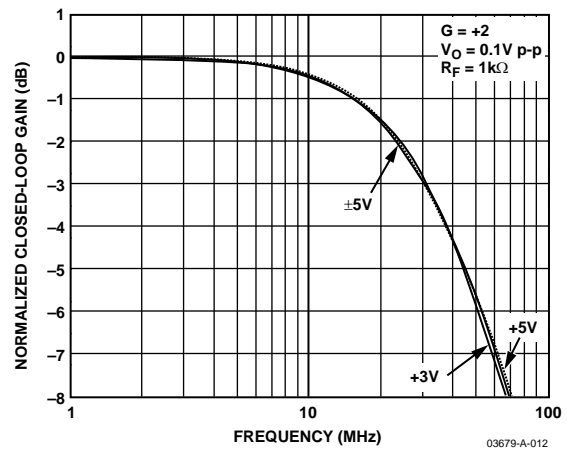

Figure 11. Small Signal Frequency Response for Various Supplies

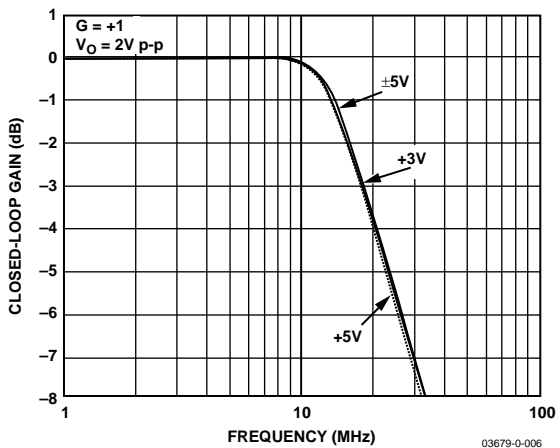

Figure 9. Large Signal Frequency Response for Various Supplies

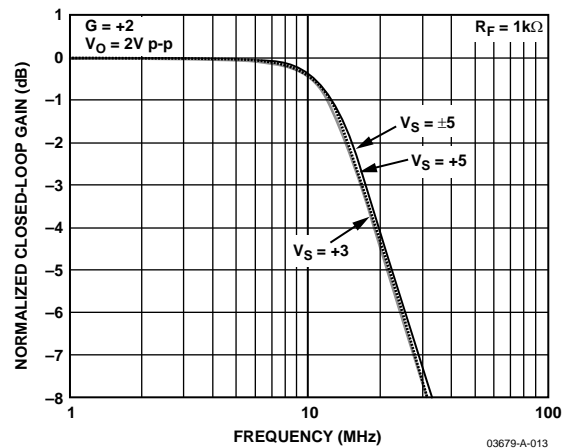

Figure 12. Large Signal Frequency Response for Various Supplies

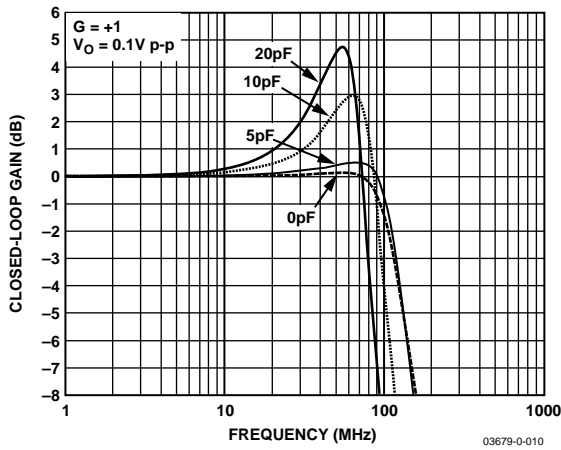

Figure 13. Small Signal Frequency Response for Various C_{LOAD}

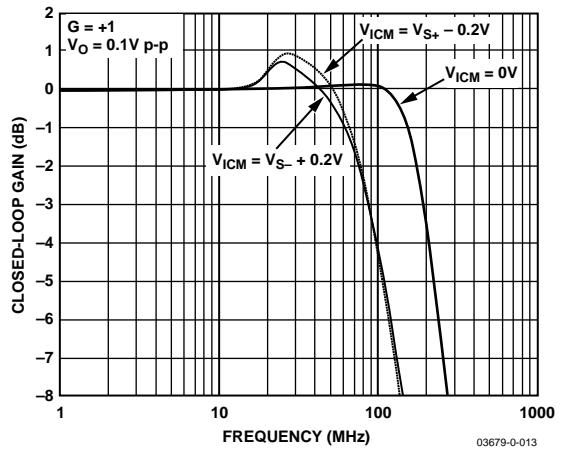

Figure 16. Small Signal Frequency Response for Various Input Common-Mode Voltages

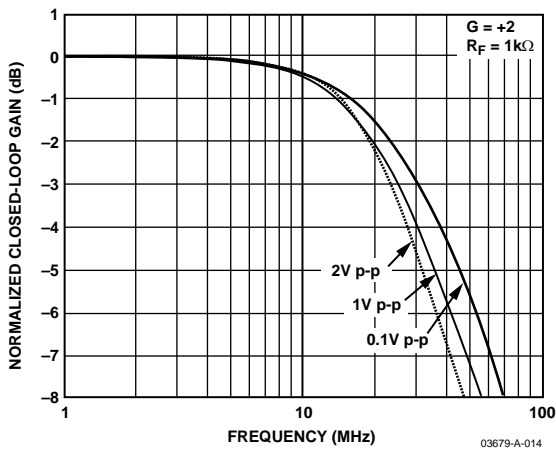

Figure 14. Frequency Response for Various Output Amplitudes

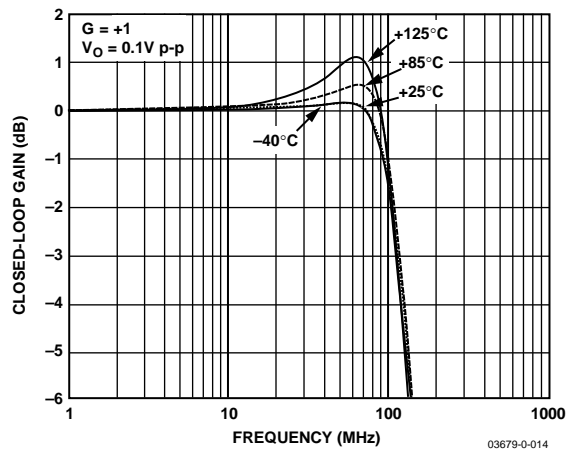

Figure 17. Small Signal Frequency Response vs. Temperature

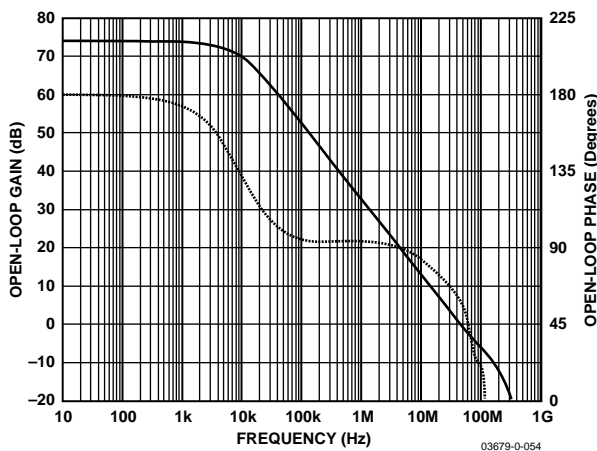

Figure 15. Open-Loop Gain and Phase vs. Frequency

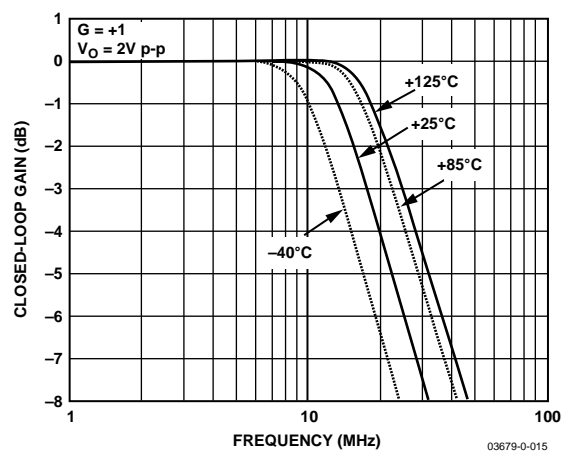

Figure 18. Large Signal Frequency Response vs. Temperature

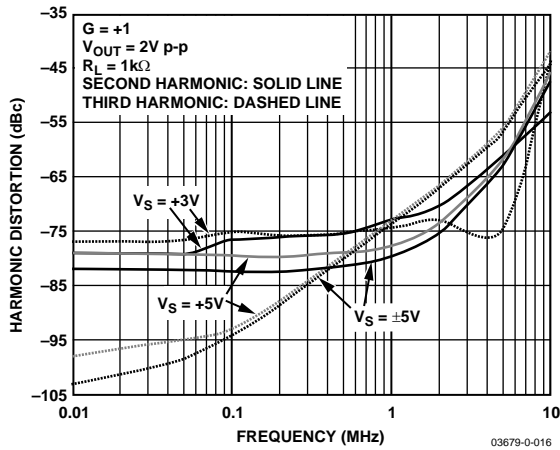

Figure 19. Harmonic Distortion vs. Frequency and Supply Voltage

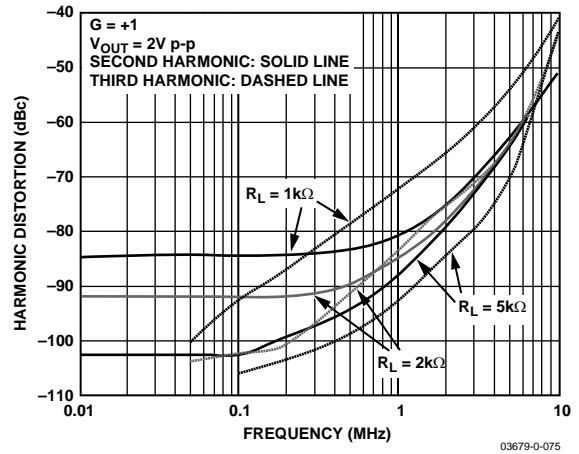

Figure 22. Harmonic Distortion vs. Frequency and Load

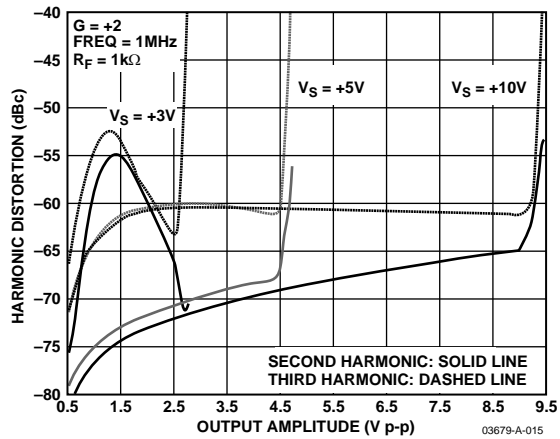

Figure 20. Harmonic Distortion vs. Output Amplitude

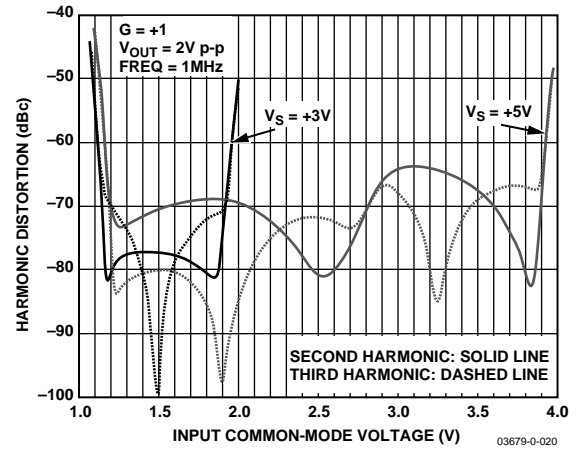

Figure 23. Harmonic Distortion vs. Input Common Mode Voltage

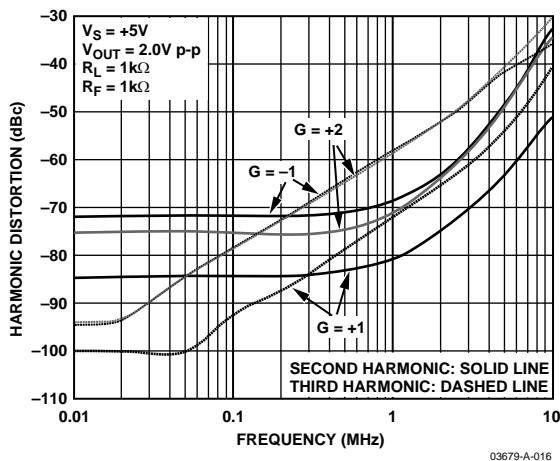

Figure 21. Harmonic Distortion vs. Frequency and Gain

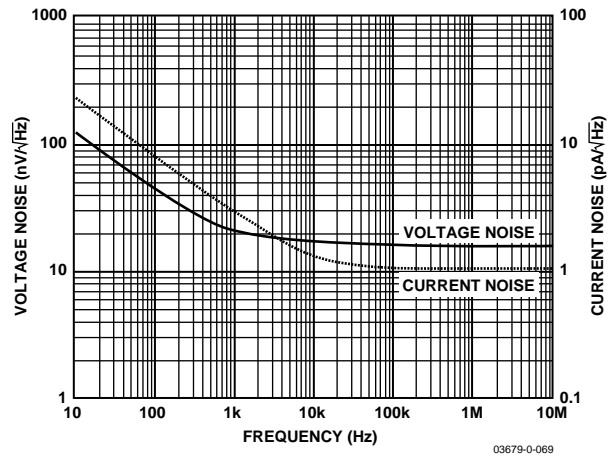

Figure 24. Voltage and Current Noise vs. Frequency

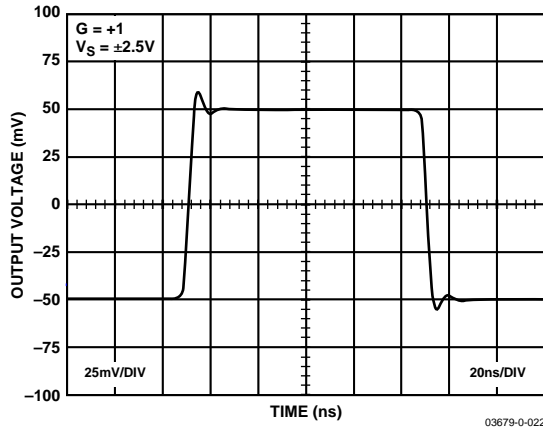

Figure 25. Small Signal Transient Response

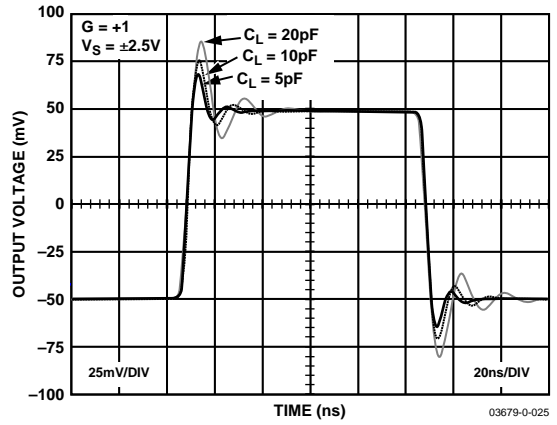

Figure 28. Small Signal Transient Response with Capacitive Load

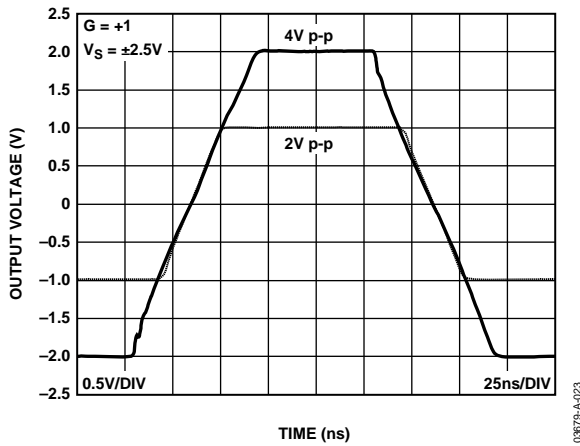

Figure 26. Large Signal Transient Response

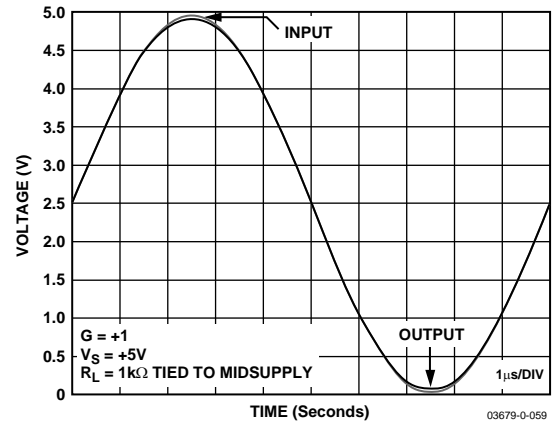

Figure 29. Rail-to-Rail Response, G = +1

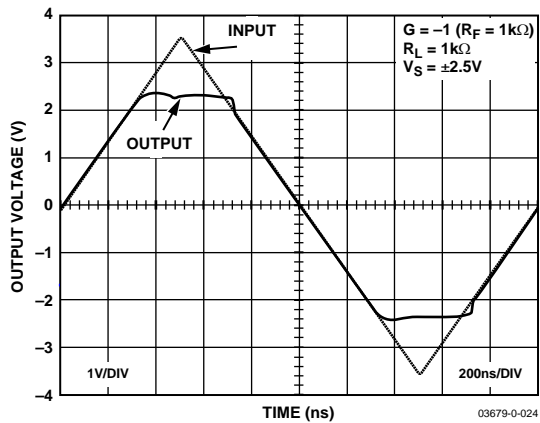

Figure 27. Output Overdrive Recovery

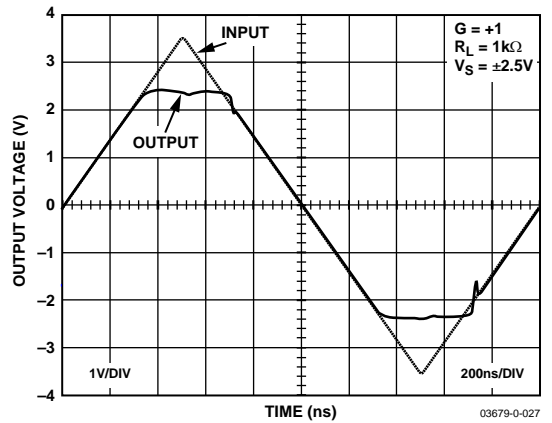

Figure 30. Input Overdrive Recovery

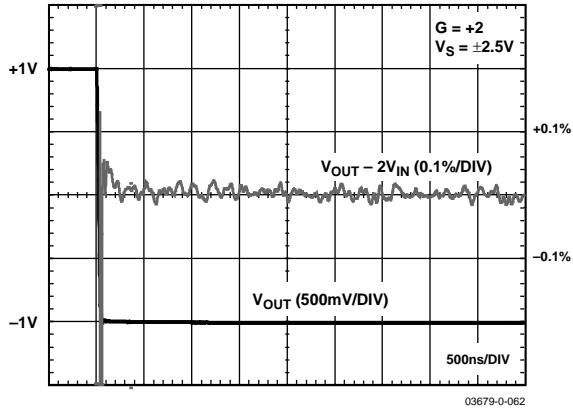

Figure 31. Long-Term Settling Time

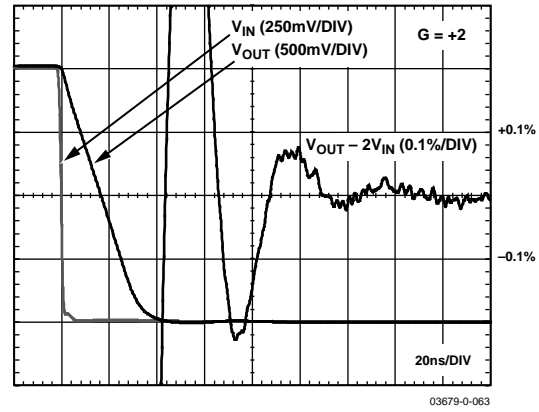

Figure 34. 0.1% Short-Term Settling Time

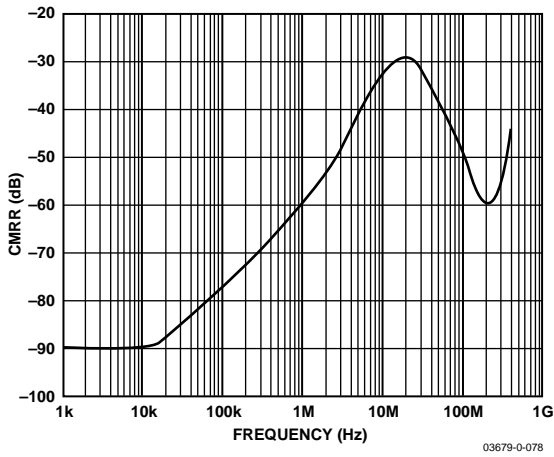

Figure 32. Common-Mode Rejection Ratio vs. Frequency

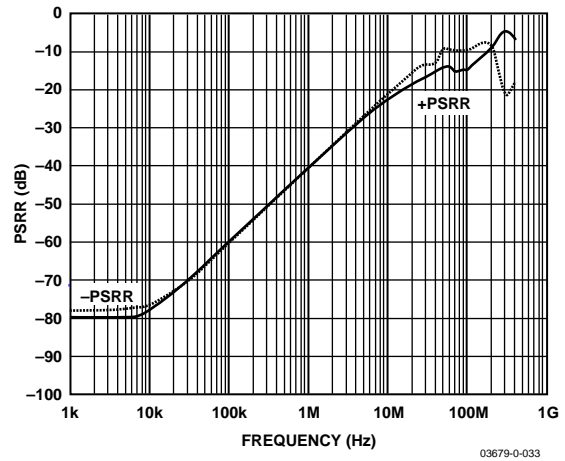

Figure 35. PSRR vs. Frequency

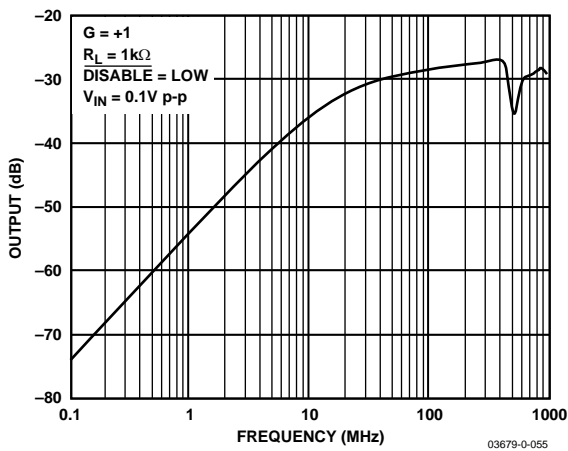

Figure 33. AD8029 Off-Isolation vs. Frequency

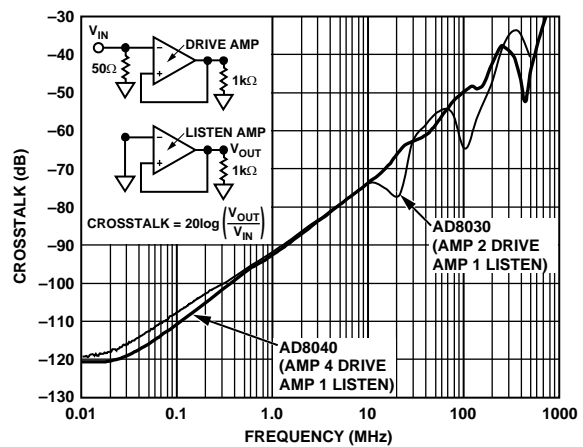

Figure 36. AD8030/AD8040 Crosstalk vs. Frequency

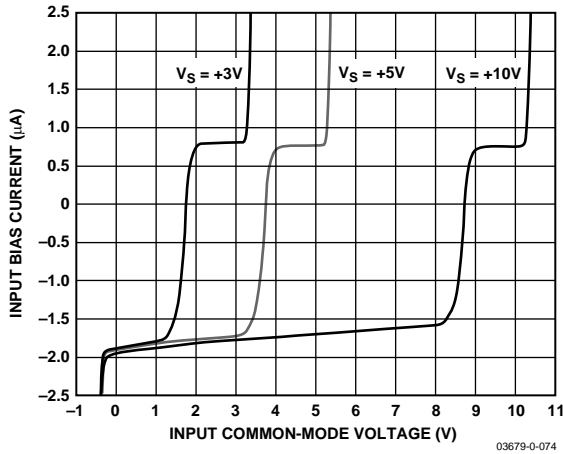

Figure 37. Input Bias Current vs. Input Common-Mode Voltage

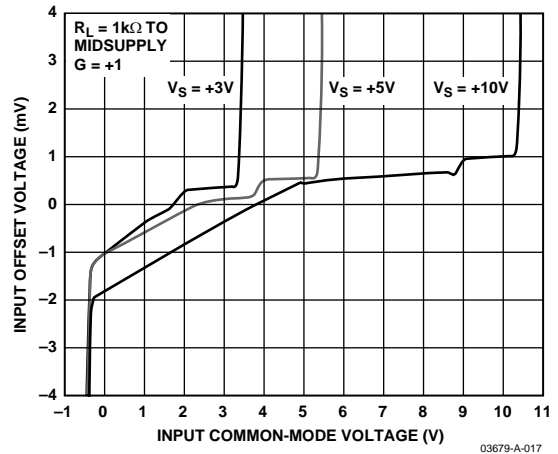

Figure 40. Input Offset Voltage vs. Input Common-Mode Voltage

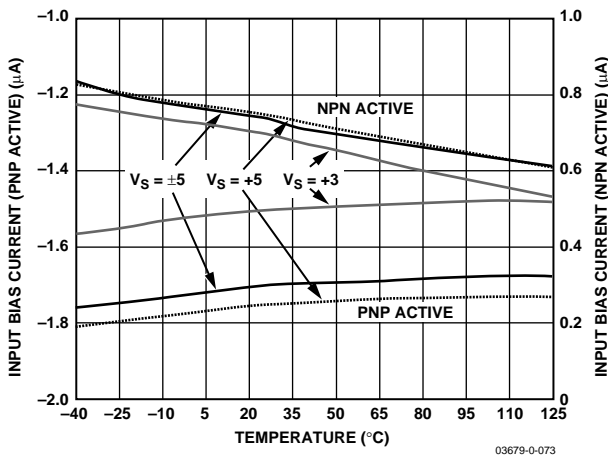

Figure 38. Input Bias Current vs. Temperature

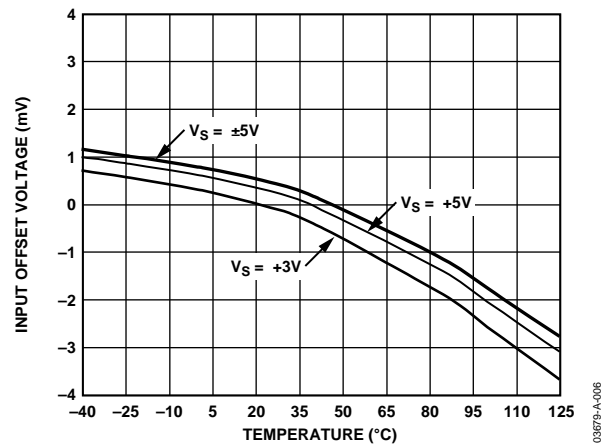

Figure 41. Input Offset Voltage vs. Temperature

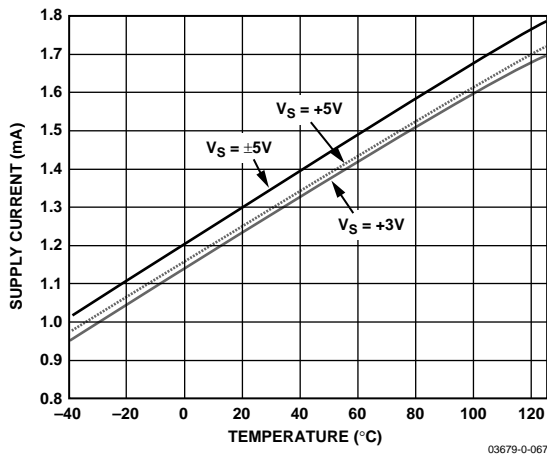

Figure 39 Quiescent Supply Current vs. Temperature

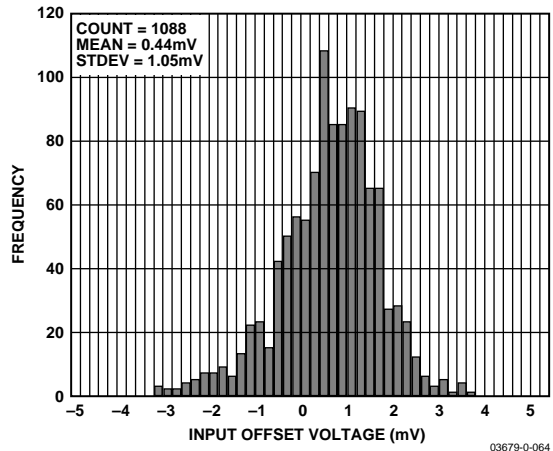

Figure 42. Input Offset Voltage Distribution

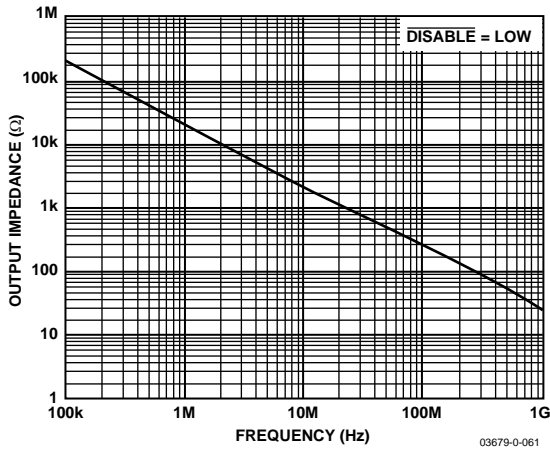

Figure 43. AD8029 Output Impedance vs. Frequency, Disabled

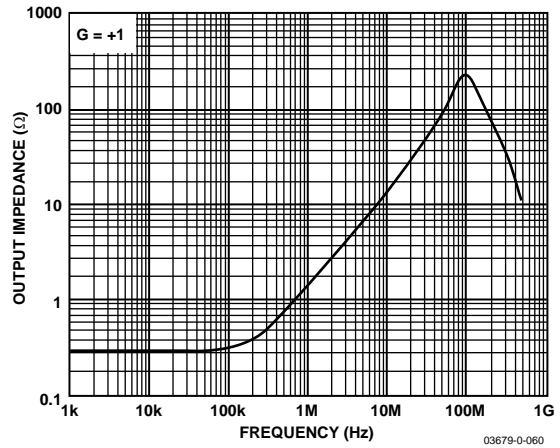

Figure 45. Output Impedance vs. Frequency, Enabled

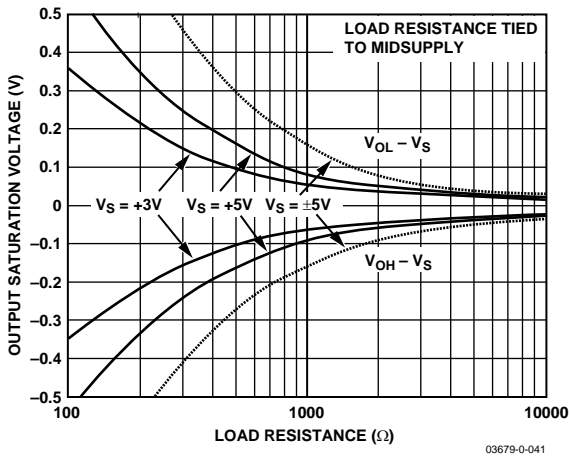

Figure 44. Output Saturation Voltage vs. Load Resistance

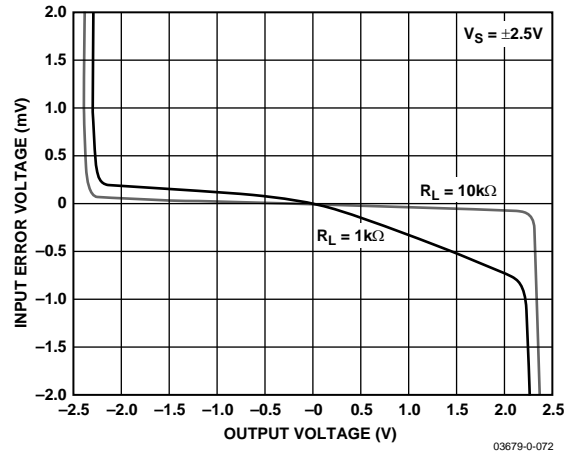

Figure 46. Input Error Voltage vs. Output Voltage

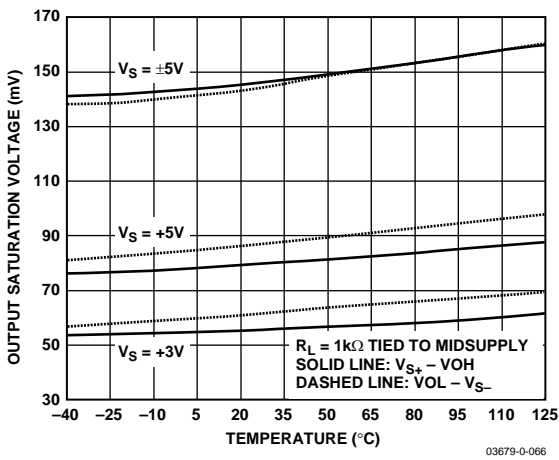

Figure 42. Output Saturation Voltage vs. Temperature

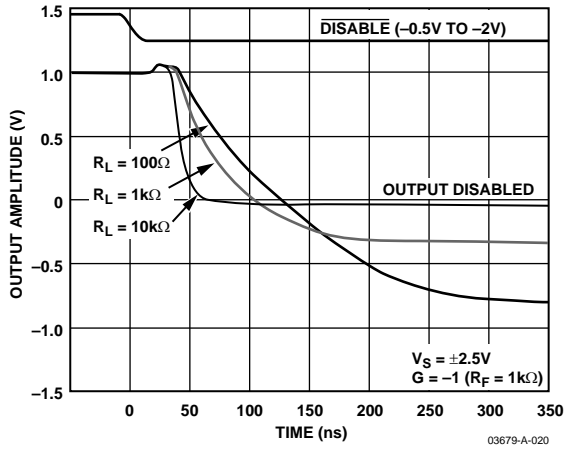

Figure 47. AD8029 $\overline{\text{DISABLE}}$ Turn-Off Timing

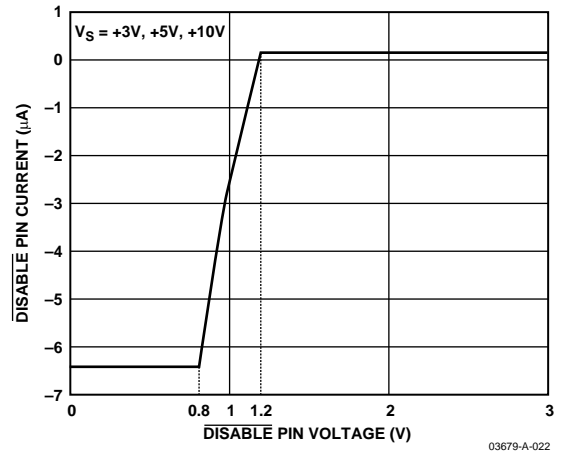

Figure 49. AD8029 $\overline{\text{DISABLE}}$ Pin Current vs. $\overline{\text{DISABLE}}$ Pin Voltage

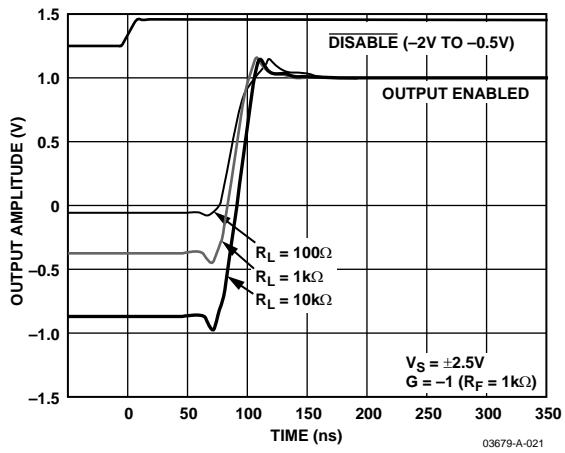

Figure 48. AD8029 $\overline{\text{DISABLE}}$ Turn-On Timing

THEORY OF OPERATION

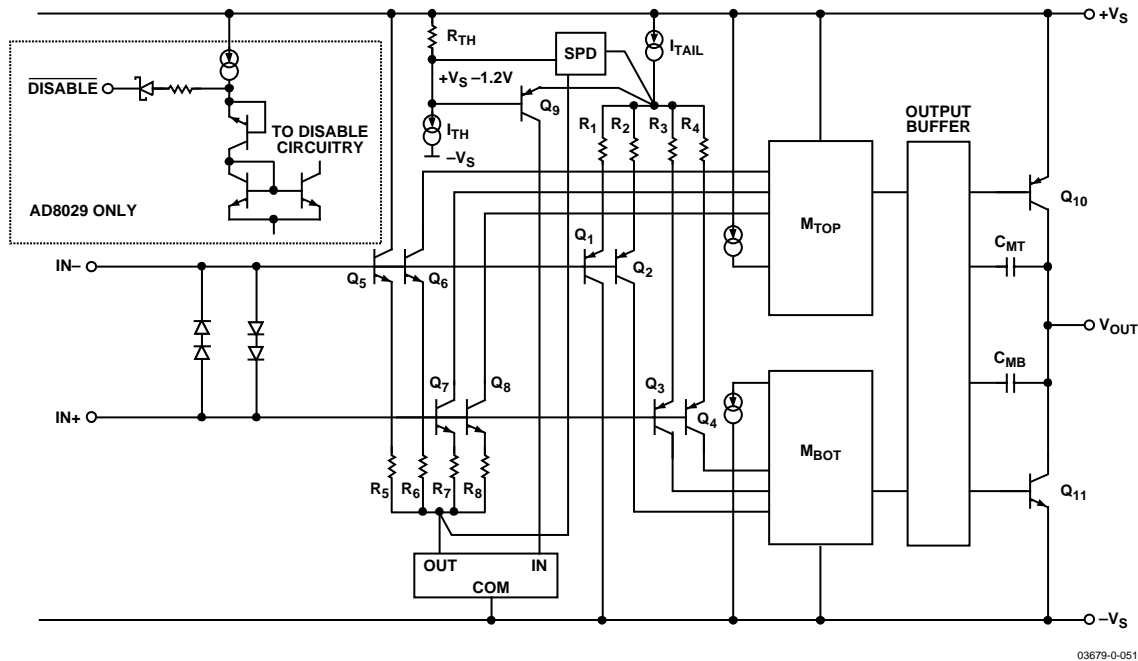

Figure 50. Simplified Schematic

The AD8029 (single), AD8030 (dual), and AD8040 (quad) are rail-to-rail input and output amplifiers fabricated using Analog Devices' XFCB process. The XFCB process enables the AD8029/AD8030/AD8040 to operate on 2.7 V to 12 V supplies with a 120 MHz bandwidth and a 60 V/ μ s slew rate. A simplified schematic of the AD8029/AD8030/AD8040 is shown in Figure 50.

INPUT STAGE

For input common-mode voltages less than a set threshold (1.2 V below V_{CC}), the resistor degenerated PNP differential pair (comprising Q_1 to Q_4) carries the entire I_{TAIL} current, allowing the input voltage to go 200 mV below $-V_S$. Conversely, input common-mode voltages exceeding the same threshold cause I_{TAIL} to be routed away from the PNP differential pair and into the NPN differential pair through transistor Q_9 . Under this condition, the input common-mode voltage is allowed to rise 200 mV above $+V_S$ while still maintaining linear amplifier behavior. The transition between these two modes of operation leads to a sudden, temporary shift in input stage transconductance, g_m , and dc parameters (such as the input offset voltage V_{OS}), which in turn adversely affect the distortion performance. The SPD block shortens the duration of this transition, thus improving the distortion performance. As shown in Figure 50, the input differential pair is protected by a pair of two series diodes, connected in anti-parallel, which clamp the differential input voltage to approximately ± 1.5 V.

OUTPUT STAGE

The currents derived from the PNP and NPN input differential pairs are injected into the current mirrors M_{BOT} and M_{TOP} , thus establishing a common-mode signal voltage at the input of the output buffer.

The output buffer performs three functions:

1. It buffers and applies the desired signal voltage to the output devices, Q_{10} and Q_{11} .
2. It senses the common-mode current level in the output devices.
3. It regulates the output common-mode current by establishing a common-mode feedback loop.

The output devices Q_{10} and Q_{11} work in a common-emitter configuration, and are Miller-compensated by internal capacitors, C_{MT} and C_{MB} .

The output voltage compliance is set by the output devices' collector resistance R_C (about 25 Ω), and by the required load current I_L . For instance, a light equivalent load (5 k Ω) allows the output voltage to swing to within 40 mV of either rail, while heavier loads cause this figure to deteriorate as $R_C \times I_L$.

APPLICATIONS

WIDEBAND OPERATION

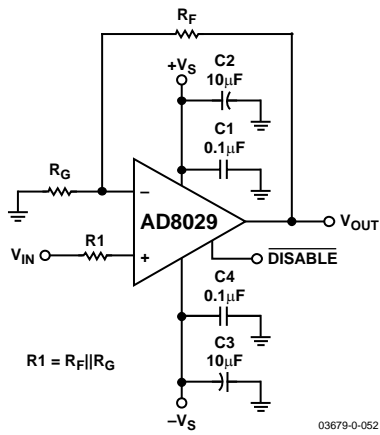

Figure 51. Wideband Non-inverting Gain Configuration

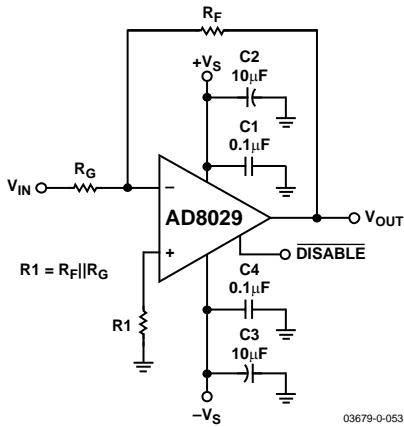

Figure 52. Wideband Inverting Gain Configuration

OUTPUT LOADING SENSITIVITY

To achieve maximum performance and low power dissipation, the designer needs to consider the loading at the output of AD8029/AD8030/AD8040. Table 5 shows the effects of output loading and performance.

When operating at unity gain, the effective load at the amplifier output is the resistance (R_L) being driven by the amplifier. For gains other than 1, in noninverting configurations, the feedback network represents an additional current load at the amplifier output. The feedback network ($R_F + R_G$) is in parallel with R_L , which lowers the effective resistance at the output of the amplifier. The lower effective resistance causes the amplifier to supply more current at the output. Lower values of feedback resistance increase the current draw, thus increasing the amplifier's power dissipation.

For example, if using the values shown in Table 5 for a gain of 2, with resistor values of 2.5 k Ω , the effective load at the output is 1.67 k Ω . For inverting configurations, only the feedback resistor R_F is in parallel with the output load. If the load is greater than that specified in the data sheet, the amplifier can introduce nonlinearities in its open-loop response, which increases distortion. Figure 53 and Figure 54 illustrate effective output loading and distortion performance. Increasing the resistance of the feedback network can reduce the current consumption, but has other implications.

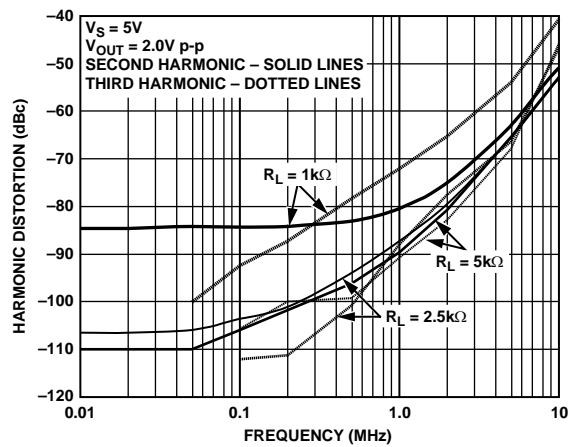

Figure 53. Gain of 1 Distortion

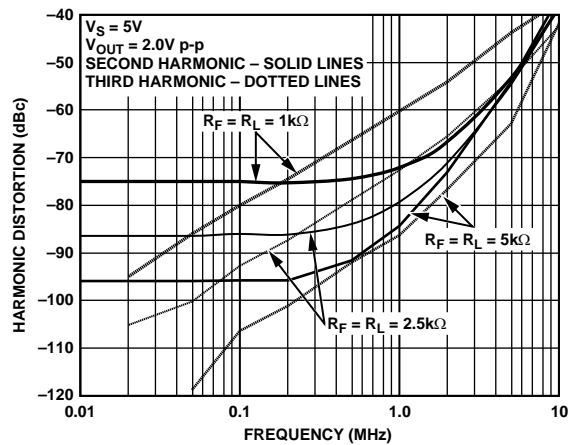

Figure 54. Gain of 2 Distortion

Table 5. Effect of Load on Performance

| Noninverting Gain | R _F (kΩ) | R _G (kΩ) | R _{LOAD} (kΩ) | -3 dB SS BW (MHz) | Peaking (dB) | HD2 at 1 MHz, 2 V p-p (dB) | HD3 at 1 MHz, 2 V p-p (dB) | Output Noise (nV/√Hz) |
|-------------------|---------------------|---------------------|------------------------|-------------------|--------------|----------------------------|----------------------------|-----------------------|
| 1 | 0 | N/A | 1 | 120 | 0.02 | -80 | -72 | 16.5 |
| 1 | 0 | N/A | 2 | 130 | 0.6 | -84 | -83 | 16.5 |
| 1 | 0 | N/A | 5 | 139 | 1 | -87.5 | -92.5 | 16.5 |
| 2 | 1 | 1 | 1 | 36 | 0 | -72 | -60 | 33.5 |
| 2 | 2.5 | 2.5 | 2.5 | 44.5 | 0.2 | -79 | -72.5 | 34.4 |
| 2 | 5 | 5 | 5 | 43 | 2 | -84 | -86 | 36 |
| -1 | 1 | 1 | 1 | 40 | 0.01 | -68 | -57 | 33.6 |
| -1 | 2.5 | 2.5 | 2.5 | 40 | 0.05 | -74 | -68 | 34 |
| -1 | 5 | 5 | 5 | 34 | 1 | -78 | -80 | 36 |

The feedback resistance (R_F || R_G) combines with the input capacitance to form a pole in the amplifier's loop response. This can cause peaking and ringing in the amplifier's response if the RC time constant is too low. Figure 55 illustrates this effect. Peaking can be reduced by adding a small capacitor (1 pF–4 pF) across the feedback resistor. The best way to find the optimal value of capacitor is to empirically try it in your circuit. Another factor of higher resistance values is the impact it has on noise performance. Higher resistor values generate more noise. Each application is unique and therefore a balance must be reached between distortion, peaking, and noise performance. Table 5 outlines the trade-offs that different loads have on distortion, peaking, and noise performance. In gains of 1, 2, and 10, equivalent loads of 1 kΩ, 2 kΩ, and 5 kΩ are shown.

With increasing load resistance, the distortion and -3 dB bandwidth improve, while the noise and peaking degrade slightly.

DISABLE PIN

The AD8029 disable pin allows the amplifier to be shut down for power conservation or multiplexing applications. When in the disable mode, the amplifier draws only 150 μA of quiescent current. The disable pin control voltage is referenced to the negative supply. The amplifier enters power-down mode any time the disable pin is tied to the most negative supply or within 0.8 V of the negative supply. If left open, the amplifier will operate normally. For switching levels, refer to Table 6.

Table 6. Disable Pin Control Voltage

| Disable Pin Voltage | Supply Voltage | | |
|---------------------|----------------|---------------|-----------------|
| | +3 V | +5 V | ±5 V |
| Low (Disabled) | 0 V to <0.8 V | 0 V to <0.8 V | -5 V to <-4.2 V |
| High (Enabled) | 1.2 V to 3 V | 1.2 V to 5 V | -3.8 V to +5 V |

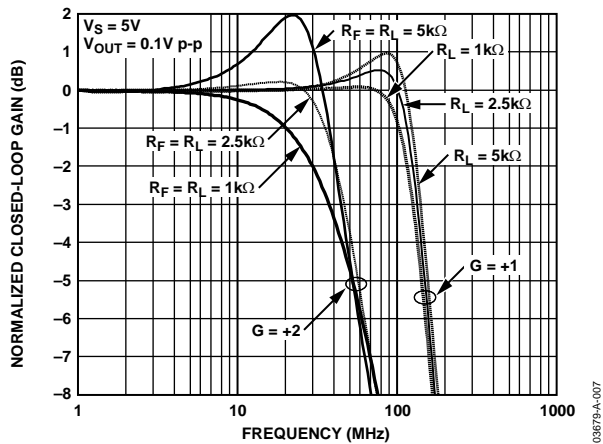

Figure 55. Frequency Response for Various Feedback/Load Resistances

CIRCUIT CONSIDERATIONS

PCB Layout

High speed op amps require careful attention to PCB layout to achieve optimum performance. Particular care must be exercised to minimize lead lengths of the bypass capacitors. Excess lead inductance can influence the frequency response and even cause high frequency oscillations. Using a multilayer board with an internal ground plane can help reduce ground noise and enable a more compact layout.

To achieve the shortest possible trace length at the inverting input, the feedback resistor, R_F , should be located the shortest distance from the output pin to the input pin. The return node of the resistor R_G should be situated as close as possible to the return node of the negative supply bypass capacitor.

On multilayer boards, all layers beneath the op amp should be cleared of metal to avoid creating parasitic capacitive elements. This is especially true at the summing junction, i.e., the inverting input, $-IN$. Extra capacitance at the summing junction can cause increased peaking in the frequency response and lower phase margin.

Grounding

To minimize parasitic inductances and ground loops in high speed, densely populated boards, a ground plane layer is critical. Understanding where the current flows in a circuit is critical in the implementation of high speed circuit design. The length of the current path is directly proportional to the magnitude of the parasitic inductances and thus the high frequency impedance of the path. Fast current changes in an inductive ground return will create unwanted noise and ringing.

The length of the high frequency bypass capacitor pads and traces is critical. A parasitic inductance in the bypass grounding works against the low impedance created by the bypass capacitor. Because load currents flow from supplies as well as from ground, the load should be placed at the same physical location as the bypass capacitor ground. For large values of capacitors, which are intended to be effective at lower frequencies, the current return path length is less critical.

Power Supply Bypassing

Power supply pins are actually inputs to the op amp. Care must be taken to provide the op amp with a clean, low noise dc voltage source.

Power supply bypassing is employed to provide a low impedance path to ground for noise and undesired signals at all frequencies. This cannot be achieved with a single capacitor type; but with a variety of capacitors in parallel the bandwidth of power supply bypassing can be greatly extended. The bypass capacitors have two functions:

1. Provide a low impedance path for noise and undesired signals from the supply pins to ground.
2. Provide local stored charge for fast switching conditions and minimize the voltage drop at the supply pins during transients. This is typically achieved with large electrolytic capacitors.

Good quality ceramic chip capacitors should be used and always kept as close as possible to the amplifier package. A parallel combination of a 0.1 μF ceramic and a 10 μF electrolytic covers a wide range of rejection for unwanted noise. The 10 μF capacitor is less critical for high frequency bypassing and, in most cases, one per supply line is sufficient. The values of capacitors are circuit-dependant and should be determined by the system's requirements.

DESIGN TOOLS AND TECHNICAL SUPPORT

Analog Devices is committed to the design process by providing technical support and online design tools. ADI offers technical support via free evaluation boards, sample ICs, Spice models, interactive evaluation tools, application notes, phone and email support—all available at www.analog.com.

OUTLINE DIMENSIONS

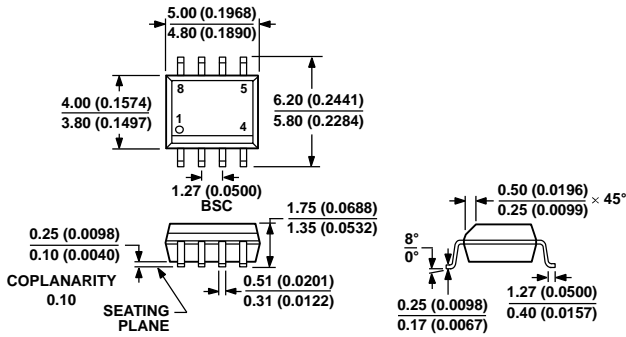

COMPLIANT TO JEDEC STANDARDS MS-012-AA
CONTROLLING DIMENSIONS ARE IN MILLIMETERS; INCH DIMENSIONS (IN PARENTHESES) ARE ROUNDED-OFF MILLIMETER EQUIVALENTS FOR REFERENCE ONLY AND ARE NOT APPROPRIATE FOR USE IN DESIGN.

Figure 56. 8-Lead Standard Small Outline Package, Narrow Body [SOIC_N] (R-8)

Dimensions shown in millimeters and (inches)

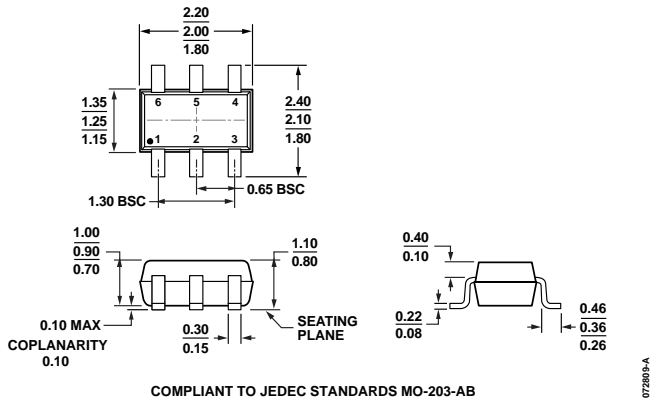

COMPLIANT TO JEDEC STANDARDS MO-203-AB

Figure 57. 6-Lead Plastic Surface-Mount Package [SC70] (KS-6)

Dimensions shown in millimeters

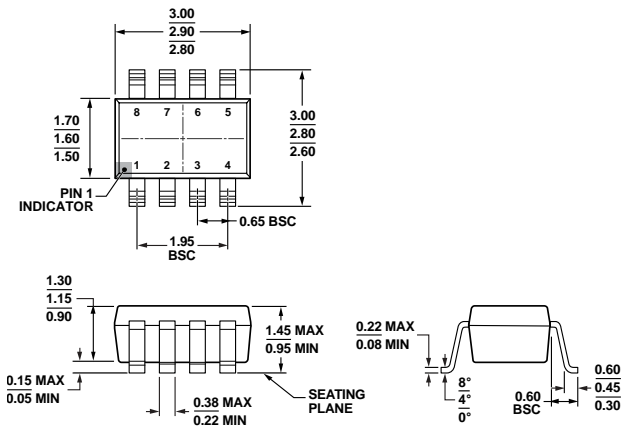

COMPLIANT TO JEDEC STANDARDS MO-178-BA

Figure 58. 8-Lead Small Outline Transistor Package [SOT-23] (RJ-8)

Dimensions shown in millimeters

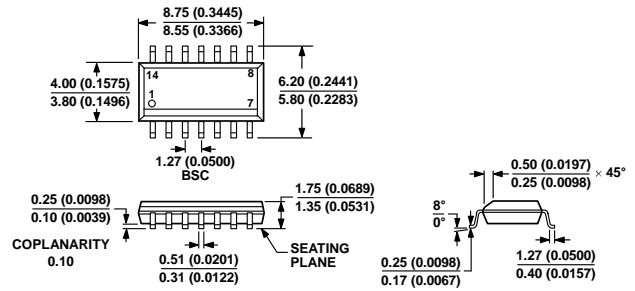

COMPLIANT TO JEDEC STANDARDS MS-012-AB
CONTROLLING DIMENSIONS ARE IN MILLIMETERS; INCH DIMENSIONS (IN PARENTHESES) ARE ROUNDED-OFF MILLIMETER EQUIVALENTS FOR REFERENCE ONLY AND ARE NOT APPROPRIATE FOR USE IN DESIGN.

Figure 59. 14-Lead Standard Small Outline Package [SOIC_N] (R-14)

Dimensions shown in millimeters and (inches)

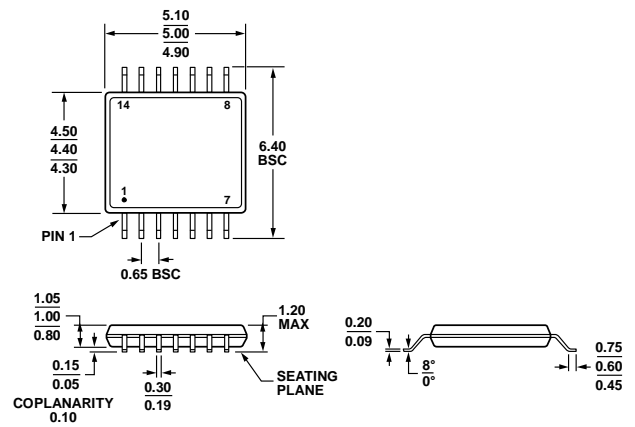

COMPLIANT TO JEDEC STANDARDS MO-153-AB-1

Figure 60. 14-Lead Thin Shrink Small Outline Package [TSSOP] (RU-14)

Dimensions shown in millimeters

ORDERING GUIDE

| Model ^{1,2} | Minimum Ordering Quantity | Temperature Range | Package Description | Package Option | Branding |
|----------------------|---------------------------|-------------------|---|----------------|----------|
| AD8029ARZ | 98 | -40°C to +125°C | 8-Lead SOIC_N | R-8 | |
| AD8029AR-REEL | 2,500 | -40°C to +125°C | 8-Lead SOIC_N | R-8 | |
| AD8029ARZ-REEL | 2,500 | -40°C to +125°C | 8-Lead SOIC_N | R-8 | |
| AD8029AR-REEL7 | 1,000 | -40°C to +125°C | 8-Lead SOIC_N | R-8 | |
| AD8029ARZ-REEL7 | 1,000 | -40°C to +125°C | 8-Lead SOIC_N | R-8 | |
| AD8029AKSZ-R2 | 250 | -40°C to +125°C | 6-Lead SC70 | KS-6 | H03 |
| AD8029AKSZ-REEL | 10,000 | -40°C to +125°C | 6-Lead SC70 | KS-6 | H03 |
| AD8029AKSZ-REEL7 | 3,000 | -40°C to +125°C | 6-Lead SC70 | KS-6 | H03 |
| AD8030AR | 98 | -40°C to +125°C | 8-Lead SOIC_N | R-8 | |
| AD8030ARZ | 98 | -40°C to +125°C | 8-Lead SOIC_N | R-8 | |
| AD8030ARZ-REEL | 2,500 | -40°C to +125°C | 8-Lead SOIC_N | R-8 | |
| AD8030ARZ-REEL7 | 1,000 | -40°C to +125°C | 8-Lead SOIC_N | R-8 | |
| AD8030ARJZ-R2 | 250 | -40°C to +125°C | 8-Lead SOT23-8 | RJ-8 | H7B |
| AD8030ARJZ-REEL | 10,000 | -40°C to +125°C | 8-Lead SOT23-8 | RJ-8 | H7B |
| AD8030ARJZ-REEL7 | 3,000 | -40°C to +125°C | 8-Lead SOT23-8 | RJ-8 | H7B |
| AD8040ARZ | 56 | -40°C to +125°C | 14-Lead SOIC_N | R-14 | |
| AD8040ARZ-REEL | 2,500 | -40°C to +125°C | 14-Lead SOIC_N | R-14 | |
| AD8040ARZ-REEL7 | 1,000 | -40°C to +125°C | 14-Lead SOIC_N | R-14 | |
| AD8040ARUZ | 96 | -40°C to +125°C | 14-Lead TSSOP | RU-14 | |
| AD8040ARU-REEL | 2,500 | -40°C to +125°C | 14-Lead TSSOP | RU-14 | |
| AD8040ARUZ-REEL | 2,500 | -40°C to +125°C | 14-Lead TSSOP | RU-14 | |
| AD8040ARUZ-REEL7 | 1,000 | -40°C to +125°C | 14-Lead TSSOP | RU-14 | |
| AD8040WARUZ-REEL7 | 1,000 | -40°C to +125°C | 14-Lead TSSOP | RU-14 | |
| AD8029AR-EBZ | | | Evaluation Board for AD8029, 8-Lead SOIC_N | | |
| AD8029AKS-EBZ | | | Evaluation Board for AD8029, 6-Lead SC70 | | |
| AD8030AR-EBZ | | | Evaluation Board for AD8030, 8-Lead SOIC_N | | |
| AD8030ARJ-EBZ | | | Evaluation Board for AD8030, 8-Lead SOT23-8 | | |
| AD8040AR-EBZ | | | Evaluation Board for AD8040, 14-Lead SOIC_N | | |
| AD8040ARU-EBZ | | | Evaluation Board for AD8040, 14-Lead TSSOP | | |

¹ Z = RoHS Compliant Part.

² W = Qualified for Automotive Applications.

AUTOMOTIVE PRODUCTS

The AD8040W models are available with controlled manufacturing to support the quality and reliability requirements of automotive applications. Note that these automotive models may have specifications that differ from the commercial models; therefore, designers should review the Specifications section of this data sheet carefully. Only the automotive grade products shown are available for use in automotive applications. Contact your local Analog Devices account representative for specific product ordering information and to obtain the specific Automotive Reliability reports for these models.

NOTES

NOTES

NOTES