



# MAX98088 Evaluation Kit

Evaluates: MAX98088

## General Description

The MAX98088 evaluation kit (EV kit) is a fully assembled and tested circuit board that evaluates the MAX98088 audio codec. The MAX98088 IC is an integrated audio codec including microphone amplifiers, line amplifiers, an earpiece amplifier, stereo Class D amplifiers, stereo DirectDrive® headphone amplifiers, and digital signal processing. The EV kit also includes Windows XP®, Windows Vista®, and Windows® 7-compatible software that provides a simple graphical user interface (GUI) for exercising the features of the IC.

The EV kit provides access to all analog and digital inputs/outputs on the IC. To enable easy connection to a wide range of audio sources, audio devices are included to convert both USB data and S/PDIF data to I<sup>2</sup>S.

The EV kit integrates a MAXQ2000 microcontroller to enable I<sup>2</sup>C communication with devices on the EV kit. The EV kit software, running on a Windows PC, communicates with the EV kit over a standard USB port. The EV kit software provides an intuitive interface to exercise the functions of the IC.

The EV kit comes with a MAX98088EWY+ installed.

## Features

- ◆ 2.8V to 5.5V Single-Supply Operation
- ◆ Proven Audio PCB Layout
- ◆ On-Board USB-to-I<sup>2</sup>C Interface Circuit
- ◆ On-Board USB-to-I<sup>2</sup>S Converter
- ◆ On-Board S/PDIF Transceiver
- ◆ On-Board Clock Source
- ◆ On-Board Digital Microphone
- ◆ Evaluates the MAX98088EWY+ in a 3.8mm x 3.3mm, 63-Bump WLP Package
- ◆ Windows XP-, Windows Vista-, and Windows 7-Compatible Software
- ◆ Fully Assembled and Tested

## Ordering Information

PART	TYPE
MAX98088EVKIT#	EV Kit

#Denotes RoHS compliant.

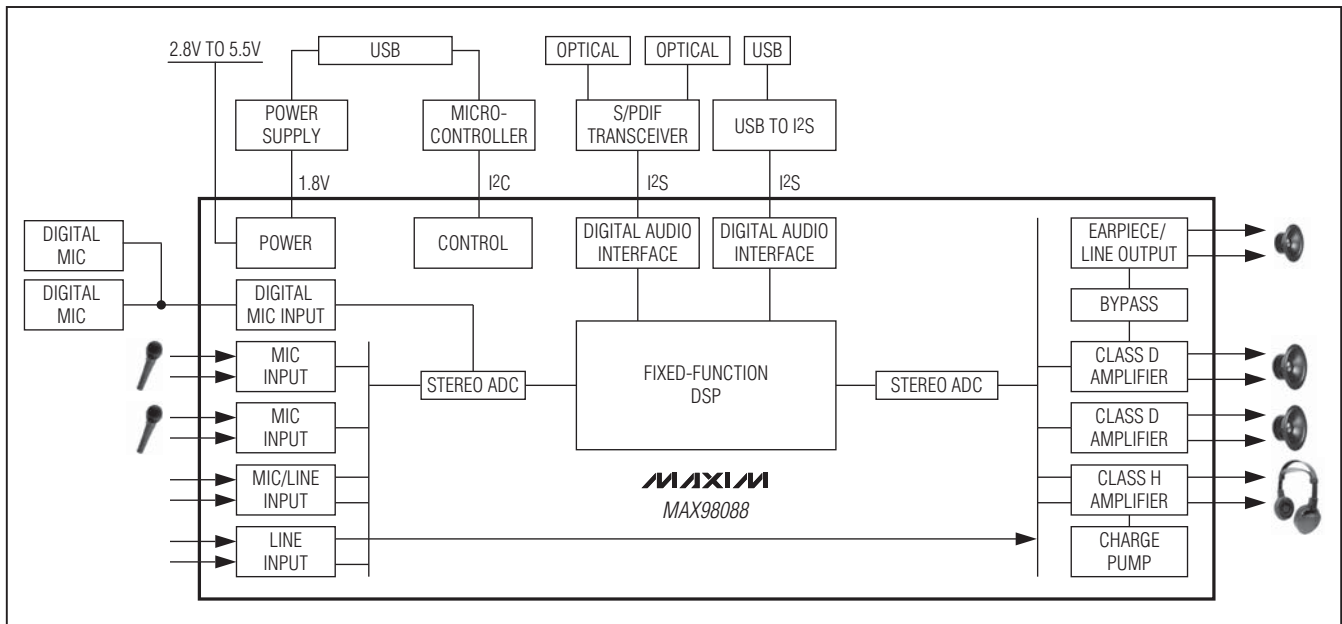

Figure 1. Block Diagram

DirectDrive is a registered trademark of Maxim Integrated Products, Inc.

Windows, Windows XP, and Windows Vista are registered trademarks of Microsoft Corp.



# MAX98088 Evaluation Kit

Evaluates: MAX98088

## Component List

DESIGNATION	QTY	DESCRIPTION
C1, C2, C52, C70	4	10 $\mu$ F $\pm$ 20% 6.3V X5R ceramic capacitors (0805) TDK C2012X5R0J106M
C3, C10, C11, C21, C22, C27, C29, C35, C40, C42, C44–C47, C51	15	0.1 $\mu$ F $\pm$ 10%, 50V X5R ceramic capacitors (0603) TDK C1608X5R1H104K
C4–C9, C122–C125	10	10pF $\pm$ 5% 50V C0G ceramic capacitors (0402) Murata GRM1555C1H100J
C12, C55, C56, C69	4	0.1 $\mu$ F $\pm$ 10%, 10V X7R ceramic capacitors (0402) KEMET C0402C104K8RAC
C14, C15, C23, C25, C43, C50, C53, C54	8	1 $\mu$ F $\pm$ 20% 6.3V X5R ceramic capacitors (0603) Taiyo Yuden JMK107B7105MA
C19, C20, C31, C32, C57	5	0.01 $\mu$ F $\pm$ 10% 50V X7R ceramic capacitors (0603) Murata GRM188R71H103K
C24, C26	2	2.2 $\mu$ F $\pm$ 10%, 6.3V X5R ceramic capacitors (0603) Murata GRM188R60J225K
C28	1	47000pF $\pm$ 10%, 25V X7R ceramic capacitor (0603) Murata GRM188R71E473K
C30	1	0.47 $\mu$ F $\pm$ 10%, 6.3V X5R ceramic capacitor (0603) Murata GRM188R60J474K
C36, C41, C73, C74	4	8pF $\pm$ 0.5pF, 50V C0H ceramic capacitors (0402) Taiyo Yuden UMK105CH080DV
C38, C58–C65, C119, C120, C132, C133	0	Not installed, ceramic capacitors (0402)
C39	1	0.033 $\mu$ F $\pm$ 10%, 25V X7R ceramic capacitor (0603) Murata GRM188R71E333K
C48, C49	2	18pF $\pm$ 5%, 50V C0G ceramic capacitors (0603) TDK C1608C0G1H180J

DESIGNATION	QTY	DESCRIPTION
C66, C72	2	47 $\mu$ F $\pm$ 20%, 6.3V X5R ceramic capacitors (1206) Murata GRM31CR60J476M
C67, C68, C71, C77, C78, C92, C93, C101–C104, C114–C118, C121, C126–C129, C131	22	1 $\mu$ F $\pm$ 10%, 6.3V X5R ceramic capacitors (0402) TDK C1005X5R0J105K
C88–C91, C134–C139	10	0.22 $\mu$ F $\pm$ 10%, 6.3V X5R ceramic capacitors (0402) TDK C1005X5R0J224K
C100	1	10 $\mu$ F $\pm$ 20% 6.3V X5R ceramic capacitor (0603) Murata GRM188R60J106M
C130	1	2.2 $\mu$ F $\pm$ 20%, 6.3V X5R ceramic capacitor (0402) Taiyo Yuden JMK105BJ225MV
D1	1	Yellow LED (0603)
D2	1	Red LED (0603)
EXTMICN, EXTMICP	0	Not installed, test points
FB1, FB2	2	Ferrite beads (0603) Murata BLM18PG221SN1
FB3–FB10	8	Ferrite beads (0402) Murata BLM15HD182SN1
FB11, FB12, FB14, FB15	4	0 $\Omega$ $\pm$ 5% resistors (0603)
FB13, FB16	2	0 $\Omega$ $\pm$ 5% resistors (0402)
HPL, HPR, SPKLP, SPKRP	4	Red multipurpose test points
J1, J10	2	USB mini-B right-angle PC-mount receptacles
J2	1	3.5mm surface-mount stereo headphone jack, 4 positions
J5	1	Digital audio optical transmitter Toshiba TOTX147L
J6	1	Digital audio optical receiver Toshiba TORX147L
J12–J15	4	Red RCA jacks
JU12	1	4-pin, 3-way header

# MAX98088 Evaluation Kit

## Component List (continued)

DESIGNATION	QTY	DESCRIPTION
JU13, JU19	2	12-pin (3 x 4) headers
JU14–JU17, JU22, JU27, JU28, JU30, JU32, JU34– JU37, JU40, JU41, JU42	16	2-pin headers
JU20	1	6-pin (2 x 3) header
L1	1	47 $\mu$ H, 220mA inductor (1812) Murata LQH43MN470J03L
L2–L5	0	Not installed, inductors (6.2mm x 6.3mm) TOKO D63CB series (22 $\mu$ H)
P101	1	-20V, -2.4A p-channel MOSFET (Super SOT3) Fairchild FDN304P
Q1	1	n-channel MOSFET (SOT23) Central Semi 2N7002
R1, R7, R9– R14, R31, R32, R33, R56, R59, R60, R61	15	0 $\Omega$ $\pm$ 5% resistors (0402)
R2, R15, R16, R29	0	Not installed, resistors (0402)
R3	1	1M $\Omega$ $\pm$ 5% resistor (0603)
R4, R28	2	10k $\Omega$ $\pm$ 5% resistors (0603)
R5	1	10k $\Omega$ $\pm$ 5% resistor (0402)
R6	1	1k $\Omega$ $\pm$ 5% resistor (0603)
R17	1	402 $\Omega$ $\pm$ 1% resistor (0603)
R18	1	47k $\Omega$ $\pm$ 5% resistor (0603)
R19, R20	2	220 $\Omega$ $\pm$ 5% resistors (0603)
R21, R22, R23	3	1.5k $\Omega$ $\pm$ 5% resistors (0603)
R24, R25	2	27 $\Omega$ $\pm$ 5% resistors (0603)
R26	1	470 $\Omega$ $\pm$ 5% resistor (0603)
R27	1	2.2k $\Omega$ $\pm$ 5% resistor (0603)
R34, R37	2	1.5k $\Omega$ $\pm$ 5% resistors (0402)
R35, R36, R39, R41, R42, R43	6	22 $\Omega$ $\pm$ 5% resistors (0402)
R38	1	1M $\Omega$ $\pm$ 5% resistor (0402)
R50, R53	2	0 $\Omega$ $\pm$ 5% resistors (0603)
R54, R55, R57, R58	4	2.2k $\Omega$ $\pm$ 5% resistors (0402)

DESIGNATION	QTY	DESCRIPTION
SPKLN, SPKRN	2	Black multipurpose test points
U1	1	Stereo audio codec (63 WLP) Maxim MAX98088EWY+
U2	1	1.8V low-noise linear regulator (5 SC70) Maxim MAX8510EXK18+ (Top Mark: AEA)
U3	1	1.8V low-noise linear regulator (5 SOT23) Maxim MAX8887EZK18+ (Top Mark: ADPX)
U4	1	Digital audio transceiver (28 SO) Cirrus Logic CS8427-CSZ
U5	1	USB audio codec (32 QFP) Texas Instruments PCM2707PJT
U7	1	UART-to-USB converter (32 QFN)
U8	1	Low-power microcontroller (56 TQFN-EP*) Maxim MAXQ2000-RBX+
U9, U16	2	3.3V low-noise linear regulators (5 SC70) Maxim MAX8511EXK33+ (Top Mark: AEI)
U10	1	93C46 type 3-wire EEPROM 16-bit architecture (8 SO)
U11	1	2.5V low-noise linear regulator (5 SC70) Maxim MAX8511EXK25+ (Top Mark: ADV)
U12	1	Digital microphone (6 LGA) Knowles Acoustic SPM0423HE4H-WB Akustica AKU2002C (Top Mark: A2002C)
U13	0	Not installed, digital microphone (6 LGA) Knowles Acoustic SPM0423HE4H-WB Akustica AKU2002C
U14, U17	2	Dual SPDT switches (10 $\mu$ DFN) Maxim MAX4906ELB+

**Evaluates: MAX98088**

# MAX98088 Evaluation Kit

## Component List (continued)

DESIGNATION	QTY	DESCRIPTION
Y2	1	13MHz crystal oscillator (2.5mm x 2.0mm)
Y3	1	16MHz crystal (3.2mm x 2.5mm)
Y4	1	12MHz crystal (3.2mm x 2.5mm)
Y5	1	6MHz crystal (HC49) Hong Kong X'tals SSL60000N1HK188F0-0

DESIGNATION	QTY	DESCRIPTION
—	4	22 $\mu$ H, 1A inductor (6.2mm x 6.3mm) TOKO #A916C4-220M
—	2	USB high-speed A-to-mini-B cables, 6ft
—	27	Shunts
—	1	PCB: MAX98088 EVALUATION KIT+

\*EP = Exposed pad.

## Component Suppliers

SUPPLIER	PHONE	WEBSITE
Central Semiconductor Corp.	631-435-1110	www.centalsemi.com
Fairchild Semiconductor	888-522-5372	www.fairchildsemi.com
Hong Kong X'tals Ltd	852-35112388	www.hongkongcrystal.com
KEMET Corp.	864-963-6300	www.kemet.com
Murata Electronics North America, Inc.	770-436-1300	www.murata-northamerica.com
Taiyo Yuden	800-348-2496	www.t-yuden.com
TDK Corp.	847-803-6100	www.component.tdk.com
TOKO America, Inc.	847-297-0070	www.tokoam.com

**Note:** Indicate that you are using the MAX98088 when contacting these component suppliers.

## MAX98088 EV Kit Files

FILE	DESCRIPTION
INSTALL.EXE	Installs the EV kit files on your computer
CDM20600.EXE	USB driver installer
CDSM2.06.00WHQLCertified.ZIP	USB driver
Device Manager	Shortcut to device manager
USB_Driver_Help_200.PDF	USB driver installation help file

# MAX98088 Evaluation Kit

## Quick Start

### Required Equipment

- MAX98088 EV kit (USB cables included)
- User-supplied Windows XP, Windows Vista, or Windows 7 PC with two available USB ports
- 2.8V to 5.5V, 1A DC power supply
- Set of headphones with a 3.5mm plug

**Note:** In the following sections, software-related items are identified by bolding. Text in **bold** refers to items directly from the EV kit software. Text in **bold and underlined** refers to items from the Windows operating system.

### Procedure

The EV kit is fully assembled and tested. Follow the steps below to configure the EV kit for audio playback and control from the PC to verify the EV kit is functioning properly.

- 1) Visit [www.maxim-ic.com/evkitsoftware](http://www.maxim-ic.com/evkitsoftware) to download the latest version of the EV kit software, 98088Rxx.ZIP. Save the EV kit software to a temporary folder and uncompress the ZIP file.
- 2) Install the EV kit software on your computer by running the INSTALL.EXE program inside the temporary folder. The program files are copied and icons are created in the Windows **Start | Programs | Maxim EVKIT Software** menu.
- 3) Verify that all jumpers are in their default positions, as shown in Table 1.
- 4) Connect the power supply between the SPKVDD and GND PCB pads.
- 5) Set the power supply to 3.7V and turn it on.
- 6) Connect a USB cable between the PC and J1 on the EV kit. A **New Hardware Found** window pops up when installing the USB driver for the first time. If a window is not seen that is similar to the one described above after 30s, remove the USB cable from the board and reconnect it. Administrator privileges are required to install the USB device driver on Windows.
- 7) Follow the directions of the **Found New Hardware** window to install the USB device driver. Manually specify the location of the device driver to be **C:\Program Files\MAX98088** (default installation directory) using the **Browse** button. During device driver installation, Windows may show a warning message indicating that the device driver Maxim uses does not contain a digital signature. This is not an error condition and it is safe to proceed with installation. Refer to the USB\_Driver\_Help\_200.PDF document included with the software for additional information.
- 8) Start the MAX98088 EV kit software by opening its icon in the **Start | Programs | Maxim EVKIT Software** menu. The EV kit software main window appears, as shown in Figure 1.
- 9) Wait while the software connects to the EV kit. Once the connection is established, the status bar at the bottom displays **USB Connected** and **MAX98088 Connected**.
- 10) Once the EV kit software has initialized, select the **Block Diagram** tab.
- 11) Click on the USB block.
- 12) Click **Yes** to automatically configure the EV kit for USB audio playback.
- 13) Connect a USB cable between the PC and J10. Windows automatically detects the EV kit has a sound card and installs the USB audio class drivers. A USB DAC option is added to the list of available playback devices. All audio played through this device is sent to the IC.
- 14) Connect headphones to the headphone jack (J2) to hear audio generated by the PC.

# MAX98088 Evaluation Kit

## Detailed Description of Software

### Graphical User Interface

The MAX98088 EV kit software uses a block diagram interface to control all the functions of the MAX98088 audio codec. Click on blocks on the **Block Diagram** tab (Figure 2) to control various functions of the IC. Each block that represents multiple control options displays a dialog box containing all available controls for that block. Blocks that represent a single option toggle the enable of that function when clicked. Blocks colored grey are disabled while blocks colored blue are enabled. Click on the **MAX98088 Power** button to enable/disable the IC.

The icon is shaded grey when the IC is in shutdown. The icon is shaded blue when the IC is enabled.

### Register Map Control Interface

To view the IC's register settings, select the **Control Registers** tab (Figure 3). The value of all control registers is displayed and updated automatically when changes are made using the graphical user interface (GUI). Click on bit names or enter register values in hexadecimal format to manually program the IC's registers. Changes to the register map automatically update the GUI.

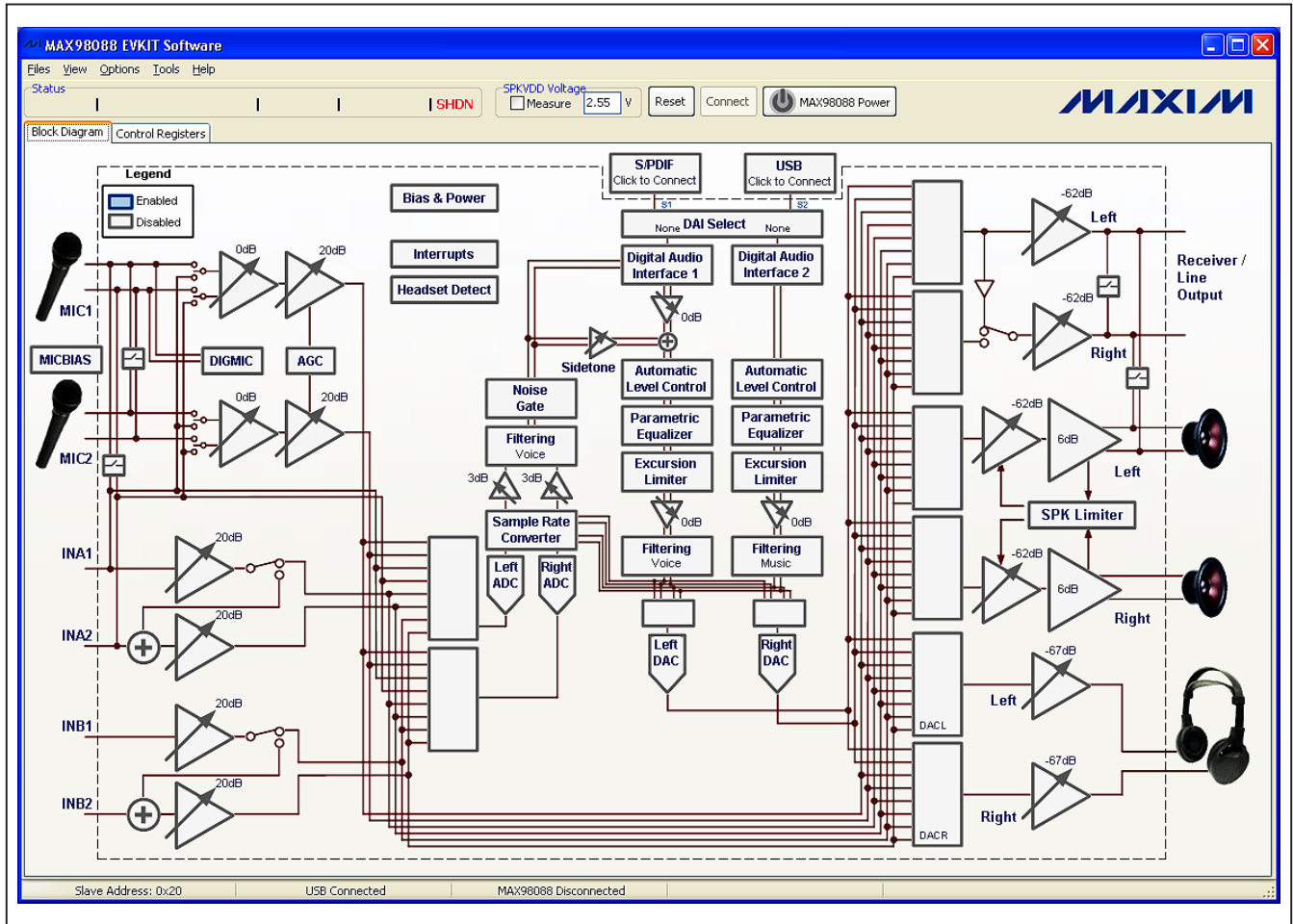

Figure 2. MAX98088 EV Kit Software Main Window (Block Diagram Tab)

# MAX98088 Evaluation Kit

Evaluates: MAX98088

**MAX98088 EVKIT Software**

Files View Options Tools Help

Status SPKVDD Voltage:  Measure 2.55 V

Block Diagram | **Control Registers**

	B7	B6	B5	B4	B3	B2	B1	B0	
<b>Status/Interrupt</b>									
0x00 Status	CLD	SLD	ULK				JDET	<input type="text" value="0x00"/>	
0x01 MIC NG/AGC	NG[2]	NG[1]	NG[0]	AGC[4]	AGC[3]	AGC[2]	AGC[1]	AGC[0]	
0x02 Jack Sense	LSNS	JKSNS	JKMIC					<input type="text" value="0x00"/>	
0x03 Battery Voltage				VBAT[4]	VBAT[3]	VBAT[2]	VBAT[1]	VBAT[0]	
0x0F Interrupt Enable	ICLD	ISLD	IULK				IJDET	<input type="text" value="0x00"/>	
<b>System Clock Control</b>									
0x10 System Clock			PSCLK[1]	PSCLK[0]				<input type="text" value="0x00"/>	
<b>DAI1 Clock Control</b>									
0x11 Clock Mode	SR1[3]	SR1[2]	SR1[1]	SR1[0]	FREQ1[3]	FREQ1[2]	FREQ1[1]	FREQ1[0]	
0x12 Anyclock Control	PLL1	NI1[14]	NI1[13]	NI1[12]	NI1[11]	NI1[10]	NI1[9]	NI1[8]	
0x13 Anyclock Control	NI1[7]	NI1[6]	NI1[5]	NI1[4]	NI1[3]	NI1[2]	NI1[1]	NI1[0]	
<b>DAI1 Configuration</b>									
0x14 Format	MAS1	WC1	BC1	DLY1		TDM1	FSW1	WS1	
0x15 Clock	AOSR1[1]	AOSR1[0]	DOSR1			BSEL1[2]	BSEL1[1]	BSEL1[0]	
0x16 I/O Configuration	SEL1[1]	SEL1[0]	LTEN1	LBEN1	DMOND1	HIZOFF1	SDOEN1	SDIEN1	
0x17 Time-Division Multiplex	SLOTL1[1]	SLOTL1[0]	SLOTR1[1]	SLOTR1[0]	SLOTDLY1[3]	SLOTDLY1[2]	SLOTDLY1[1]	SLOTDLY1[0]	
0x18 Filters	MODE1	AVFLT1[2]	AVFLT1[1]	AVFLT1[0]	DHF1	DVFLT1[2]	DVFLT1[1]	DVFLT1[0]	
<b>DAI2 Clock Control</b>									
0x19 Clock Mode	SR2[3]	SR2[2]	SR2[1]	SR2[0]				<input type="text" value="0x00"/>	
0x1A Anyclock Control	PLL2	NI2[14]	NI2[13]	NI2[12]	NI2[11]	NI2[10]	NI2[9]	NI2[8]	
0x1B Anyclock Control	NI2[7]	NI2[6]	NI2[5]	NI2[4]	NI2[3]	NI2[2]	NI2[1]	NI2[0]	
<b>DAI2 Configuration</b>									
0x1C Format	MAS2	WC2	BC2	DLY2		TDM2	FSW2	WS2	
0x1D Clock			DOSR2			BSEL2[2]	BSEL2[1]	BSEL2[0]	
0x1E I/O Configuration	SEL2[1]	SEL2[0]		LBEN2	DMOND2	HIZOFF2	SDOEN2	SDIEN2	

Slave Address: 0x20    USB Disconnected    MAX98088 Disconnected

Figure 3. MAX98088 EV Kit Software Main Window (Control Registers Tab)



# MAX98088 Evaluation Kit

## Global Control Buttons

Buttons at the top of the EV kit software window control the connection and synchronization of the software with the IC.

Press **Reset** to restore the EV kit to power-on default settings. Uncheck options that need not be reset.

Press **Connect** to reconnect to the EV kit after the software is started. The **Connect** button is disabled when the software is already connected to the EV kit. The **Connect** button is used primarily if the EV kit is connected to the PC after the software is already running.

## File Menu

The EV kit software can save its state to a configuration file for loading at a later time. Select the **Save Settings** menu item from the **File** menu bar to save the current configuration. A **Save As** dialog box appears to allow the location for the saved file to be selected. Files are saved with the extension .ax26.

Select **Load Settings** to revert to a saved configuration. An **Open** dialog box appears to allow the location of the saved configuration file to be specified. The default directory lists several presaved options. Alternatively, .ax26 files are associated with the EV kit software. Double click on a saved file to launch the EV kit software and load the saved configuration.

Select **Exit** to exit the software.

## View Menu

The **Show S/PDIF Transceiver Registers** menu item under the **View** menu bar displays a new tab sheet for manually controlling the CS8427.

## Options Menu

When the **Auto Connect** menu item is selected from the **Options** menu bar, the software automatically connects to the EV kit board as soon as the connection is available.

When **Auto Read Status** is selected, the software automatically reads the device registers every 1000ms.

The **I<sup>2</sup>C Clock Speed** submenu item selects the speed of the I<sup>2</sup>C interface as either 400kHz or 100kHz.

**Configure MCLK Routing** selects which clock source is connected to the IC.

## Tools Menu

Select the **Debug Tools** menu item under the **Tools** menu bar to directly send I<sup>2</sup>C commands to the EV kit.

Select **Export Register Setup File** to export the value of all registers set to a nondefault setting.

Select **Read All Registers** to update the software settings with the register settings of the connected EV kit. This option is useful if the EV kit software is restarted without power cycling the EV kit.

Select **Write All Registers** to download all software settings to the connected EV kit. This option is useful when power has been removed from the IC. Pressing the **Write All Registers** button is only necessary when the IC's entire register bank needs updating. Individual register changes are made automatically.

## Detailed Description of Hardware

The MAX98088 EV kit evaluates the MAX98088 audio codec and provides access to all analog and digital inputs/outputs on the device. In addition, the EV kit includes support circuitry that eases evaluation of the device.

## Power Supplies

The EV kit requires a single 2.8V to 5.5V external supply to operate. For evaluation other than power consumption, all other supplies are generated from USB bus power. Jumpers JU14–JU17, and JU22 (see Table 1) allow all supplies on the IC to be disconnected from USB bus power and powered externally. This allows varying the supply voltage and performing supply current measurements.

## Class D Filters

The IC integrates stereo Class D amplifiers. Although these amplifiers are designed to operate completely filterless, filters are often helpful during evaluation. Stuffing options for two types of filters are provided on the EV kit.

When long speaker cables are used with the IC, a ferrite bead plus capacitor filter can be installed to prevent excessive EMI radiation. Although it is best to choose filter components based on EMI test results, the combination of a 680pF capacitor with the Murata BLM18SG331TN1 ferrite bead generally works well.

To allow analysis of the audio output with an oscilloscope, or an analyzer not designed to accept Class D switching waveforms, populate L2–L5 with the included 22μH inductors and make connections to external equipment and speakers at FSPKLP, FSPKLN, FSPKRP, and FSPKRN. The LC filter is designed to work best with an 8Ω load. Do not connect the load at SPKLP, SPKLN, SPKRP, and SPKRN when L2–L5 are installed.



# MAX98088 Evaluation Kit

**Evaluates: MAX98088**

## S/PDIF Transceiver

The CS8427 S/PDIF transceiver serves as a format converter between I<sup>2</sup>S and S/PDIF. Use this device to send and receive digital audio over the optical connectors (J5, J6).

When receiving S/PDIF data, the CS8427 outputs a recovered master clock that is exactly 256 x f<sub>s</sub>, where f<sub>s</sub> is the sample rate. This clock signal can be used to clock the IC.

When transmitting S/PDIF data, the CS8427 requires a master-clock input. If S/PDIF data is also being received, the CS8427 uses this data to generate its own master clock. If S/PDIF data is not being received, then the CS8427 generates a master clock based on the LRCLK signal being output by the IC. For proper transmit-only operation, the IC must be configured in master mode.

## USB Audio

The PCM2707 USB DAC generates I<sup>2</sup>S audio data from a USB connection to the PC. The PCM2707 supports standard class drivers that are included in most operat-

ing systems. As a result, no drivers are required for this device. The PCM2707 appears as a sound card in the PC and allows audio playback from the PC through the IC. The PCM2707 also generates a master-clock signal that can be used to clock the IC. The clock signal is 256 x f<sub>s</sub>.

## Digital Microphone

The EV kit includes an on-board digital microphone to demonstrate the digital microphone input. Install shunts on jumpers JU27 and JU32 to enable the microphone. When using the digital microphone, the MIC1 analog microphone input cannot be used. If a second digital microphone is added, then MIC2 is also unavailable.

## Jumper Selection

The EV kit includes 20 jumpers to adjust various hardware configuration options. Table 1 describes all the jumpers available on the EV kit.

**Table 1. Jumper Selection**

JUMPER	SHUNT POSITION	DESCRIPTION
JU12	—	See Table 2
JU13	—	See Table 3
JU14	1-2*	Connects 1.8V to DVDD
	Open	Allows external powering of DVDD
JU15	1-2*	Connects 1.8V to AVDD
	Open	Allows external powering of AVDD
JU16	1-2*	Connects 1.8V to HPVDD
	Open	Allows external powering of HPVDD
JU17	1-2*	Connects 3.3V to DVDDS1
	Open	Allows external powering of DVDDS1
JU19	—	See Table 3
JU20	2-3*, 5-6*	Connects the on-board I <sup>2</sup> C master to the IC
	Open	Allows external control of the IC over I <sup>2</sup> C
JU22	1-2*	Connects 3.3V to DVDDS2
	Open	Allows external powering of DVDDS2
JU27	1-2	Connects the digital microphone data output to the IC
	Open*	Disconnects the digital microphone data output from the IC
JU28	1-2*	Connects the MAX98088 interrupt output ( $\overline{\text{IRQ}}$ ) to the on-board microcontroller
	Open	Disconnects the MAX98088 interrupt output ( $\overline{\text{IRQ}}$ ) to the on-board microcontroller
JU30	1-2	Connects JACKSNS to MIC1 for jack detection
	Open*	Disconnects JACKSNS from MIC1
JU32	1-2	Connects the digital microphone clock input to the IC
	Open*	Disconnects the digital microphone clock input from the IC

# MAX98088 Evaluation Kit

**Table 1. Jumper Selection (continued)**

JUMPER	SHUNT POSITION	DESCRIPTION
JU34	1-2	Connects a 2.2kΩ resistor from MIC1N to ground for microphone biasing
	Open*	Disconnects MIC1N from ground
JU35	1-2	Connects a 2.2kΩ resistor from MIC2N to ground for microphone biasing
	Open*	Disconnects MIC2N from ground
JU36	1-2	Grounds MIC1N for single-ended operation on MIC1
	Open*	Enables differential operation on MIC1
JU37	1-2	Grounds MIC2N for single-ended operation on MIC2
	Open*	Enables differential operation on MIC2
JU40	1-2	Connects MIC1P to MICBIAS through a 2.2kΩ resistor
	Open*	Disconnects MIC1P from MICBIAS
JU41	1-2	Connects MIC2P to MICBIAS through a 2.2kΩ resistor
	Open*	Disconnects MIC2P from MICBIAS
JU42	1-2*	Allows software to sense that a voltage is applied to SPKVDD (through SPKVDD_ POWERED net driving the MAXQ2000)
	Open	Disconnects Q1 for accurate SPKVDD supply current measurement

\*Default position.

### Master Clock Selection

Jumper JU12 selects which master-clock source clocks the IC. The available clocks are shown in Table 2. The EV kit software indicates the correct clock source to use depending on which audio source is in use. If an external audio source is used, choose either the on-board 13MHz oscillator or an external clock. To connect the external clock, remove the shunt from JU12 and connect the clock to the center pin.

### Digital Audio Interface

Jumpers JU13 and JU19 provide access to the digital audio interfaces on the IC. See Table 3 for individual pin descriptions. When using the on-board USB and S/PDIF audio sources, install shunts between pins 2-3 on each row. When using an external audio source, remove the shunts and connect the audio source clock and data lines to position 2 of the header. Position 1 on each row provides a convenient ground connection.

**Table 2. MAX98088 Clock Sources (JU12)**

SHUNT POSITION	CLOCK SOURCE
1-2	Disabled
1-3	13MHz oscillator
1-4*	Software-selected clock source

\*Default position.

### Control Interface

Jumper JU20 connects the on-board I<sup>2</sup>C master to the IC. When using an external I<sup>2</sup>C master, remove both shunts from JU20 and connect position 1 to SDA and SCL on the external I<sup>2</sup>C master. Install pullup resistors at R15 and R16 if the external master does not include pullup resistors.

### Microphone Bias and Jack Sense

Jumpers JU34–JU37, JU40, and JU41 provide microphone biasing on MIC1 and MIC2. To provide microphone bias, install a shunt on JU40 and JU41. For single-ended microphone inputs, install shunts on JU36 and JU37. For differential microphone inputs, install shunts on JU34 and JU35.

To enable microphone detection on MIC1, install a shunt on JU30.

# MAX98088 Evaluation Kit

Evaluates: MAX98088

**Table 3. Digital Audio Interface (JU13, JU19)**

JUMPER	POSITION 1	POSITION 2	POSITION 3
JU13	GND	BCLKS1 (IC)	BCLK (S/PDIF)
	GND	LRCLKS1 (IC)	LRCLK (S/PDIF)
	GND	SDINS1 (IC)	DAC input (S/PDIF)
	GND	SDOOTS1 (IC)	ADC output (S/PDIF)
JU19	GND	BCLKS2 (IC)	BCLK (USB audio)
	GND	LRCLKS2 (IC)	LRCLK (USB audio)
	GND	SDINS2 (IC)	DAC input (USB audio)
	GND	SDOOTS2 (IC)	ADC output (USB audio)

**Note:** Default shunt position is between pins 2-3 for all rows.

# MAX98088 Evaluation Kit

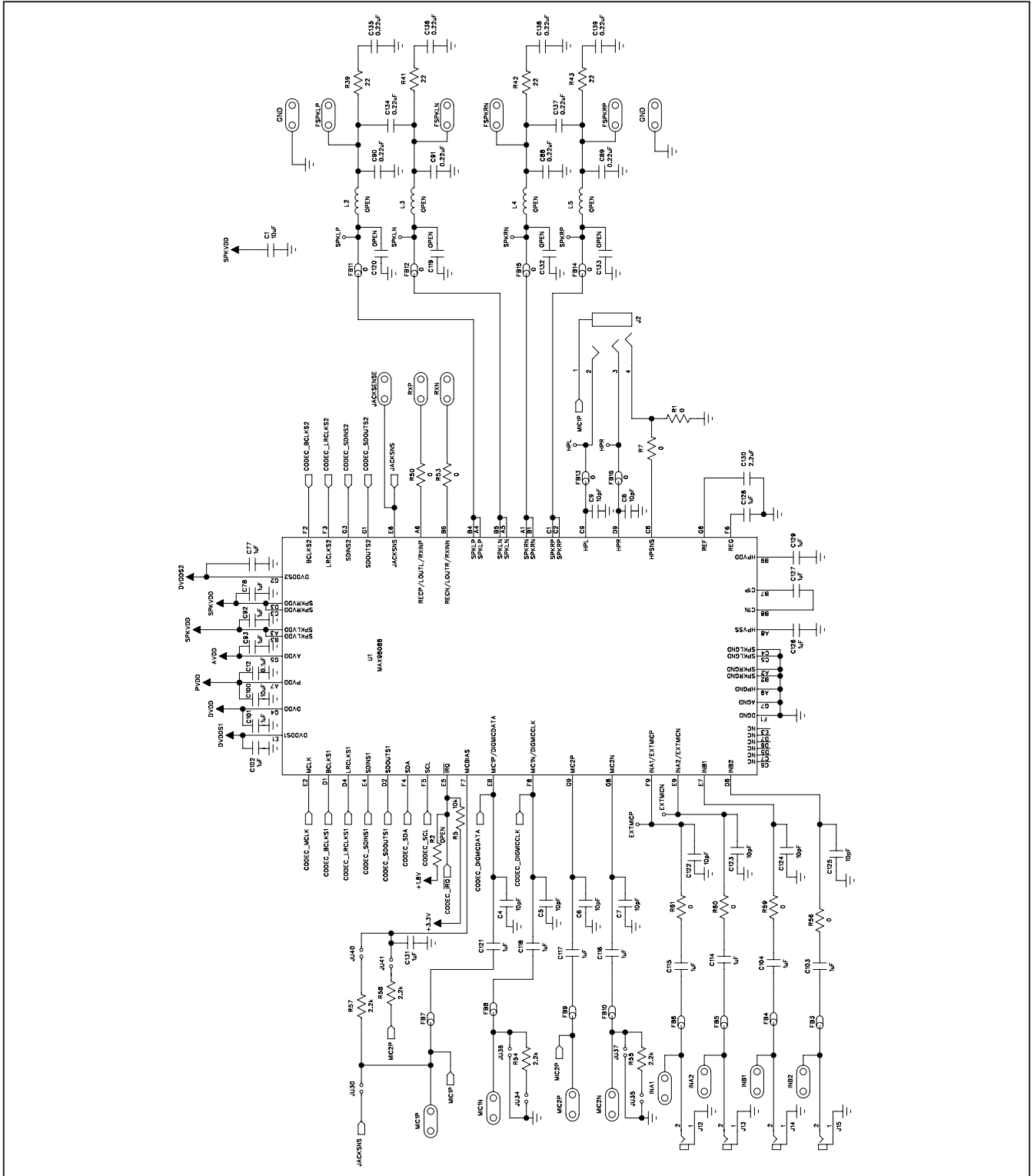

Figure 4a. MAX98088 EV Kit Schematic (Sheet 1 of 5)

# MAX98088 Evaluation Kit

Evaluates: **MAX98088**

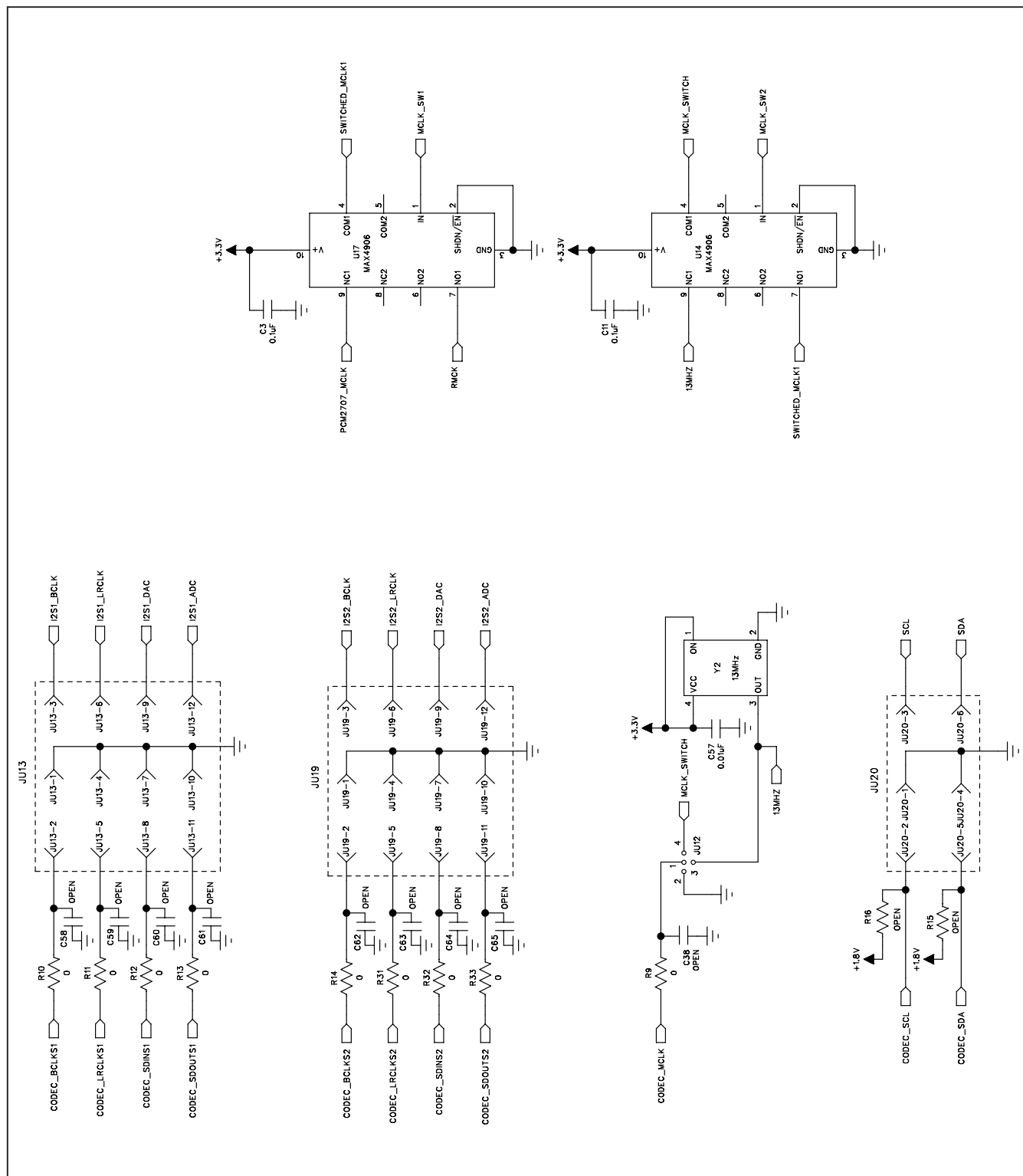

Figure 4b. MAX98088 EV Kit Schematic (Sheet 2 of 5)

# MAX98088 Evaluation Kit

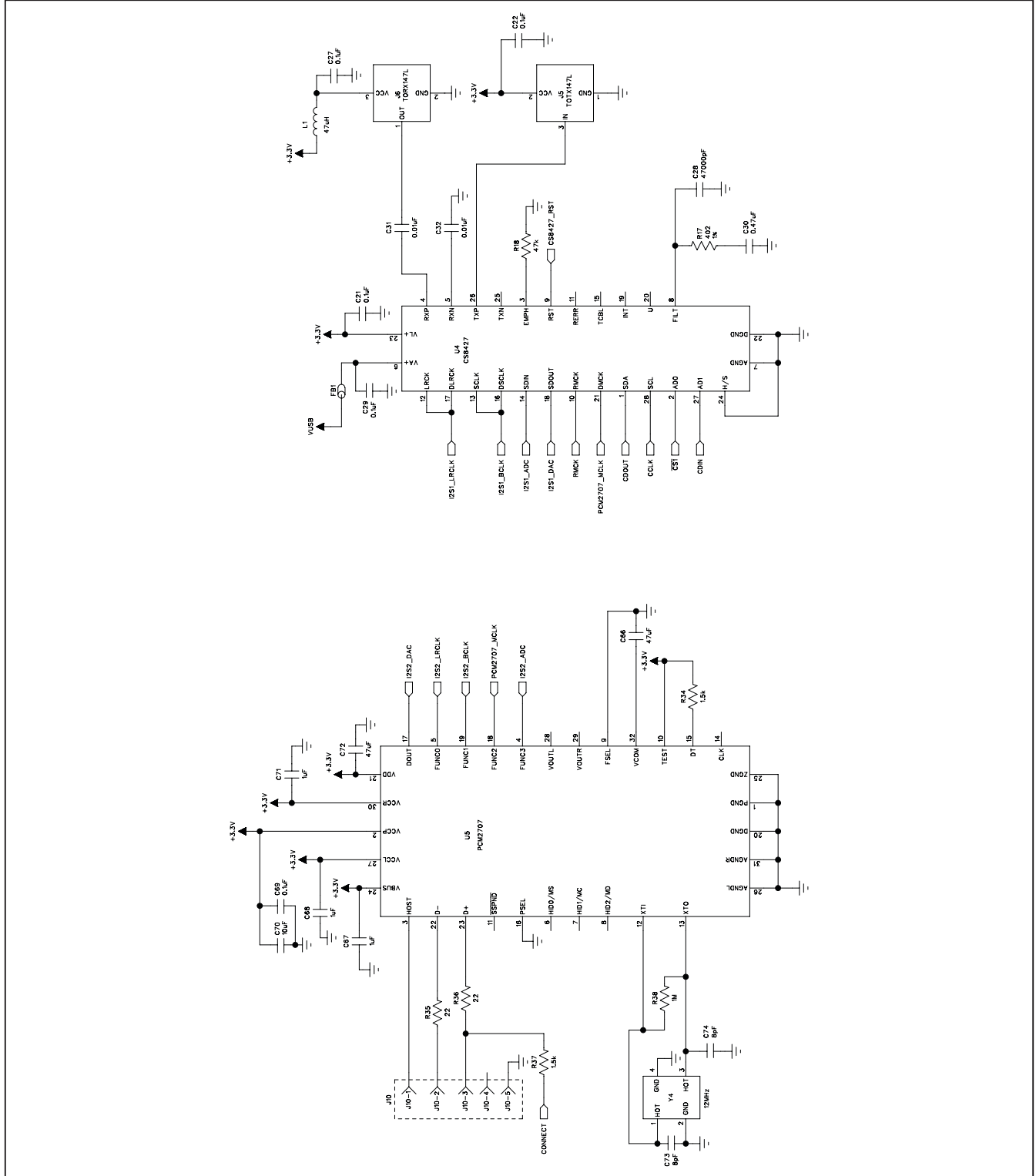

Figure 4c. MAX98088 EV Kit Schematic (Sheet 3 of 5)



# MAX98088 Evaluation Kit

Evaluates: **MAX98088**

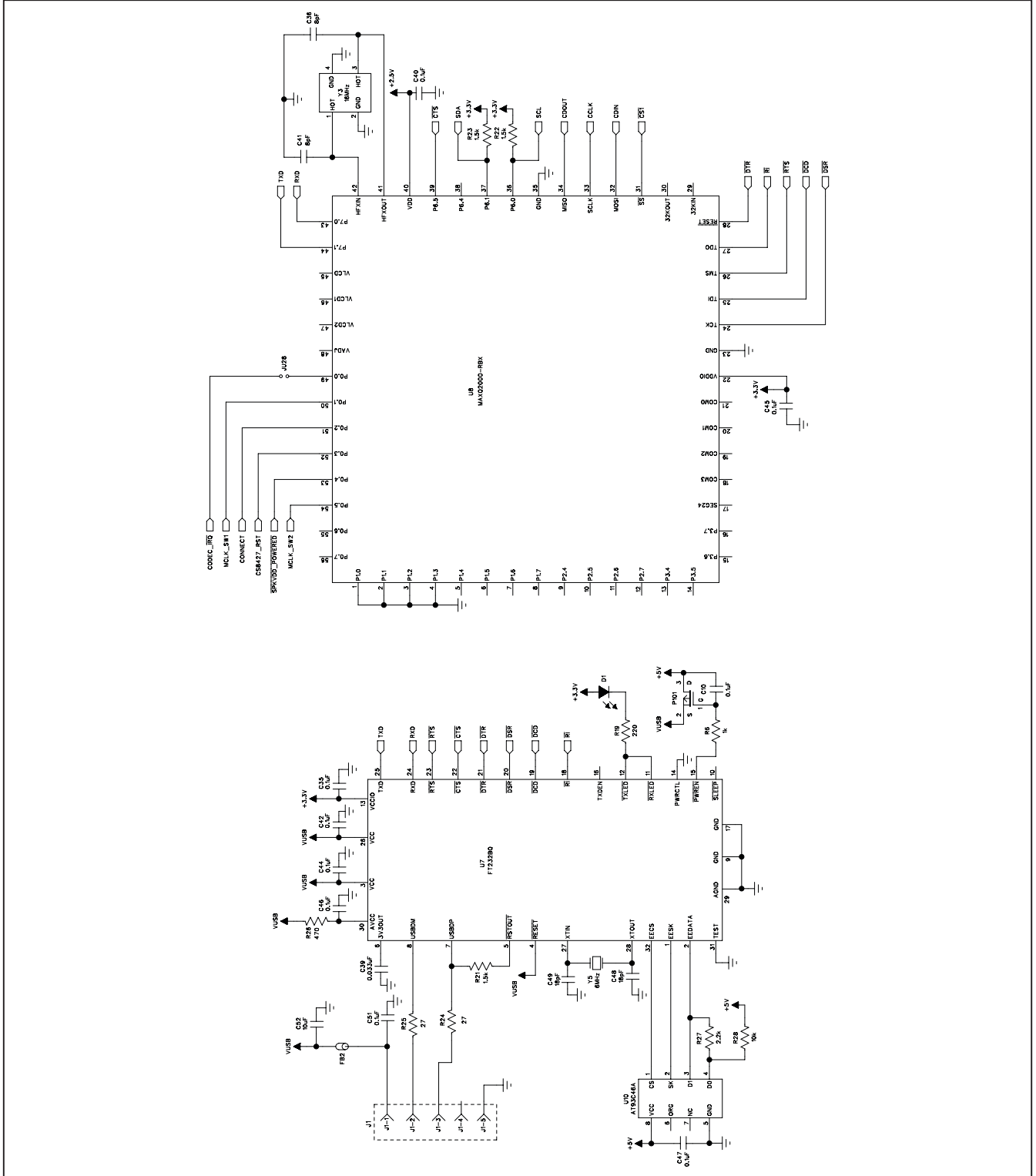

Figure 4d. MAX98088 EV Kit Schematic (Sheet 4 of 5)

# Evaluates: MAX98088

## MAX98088 Evaluation Kit

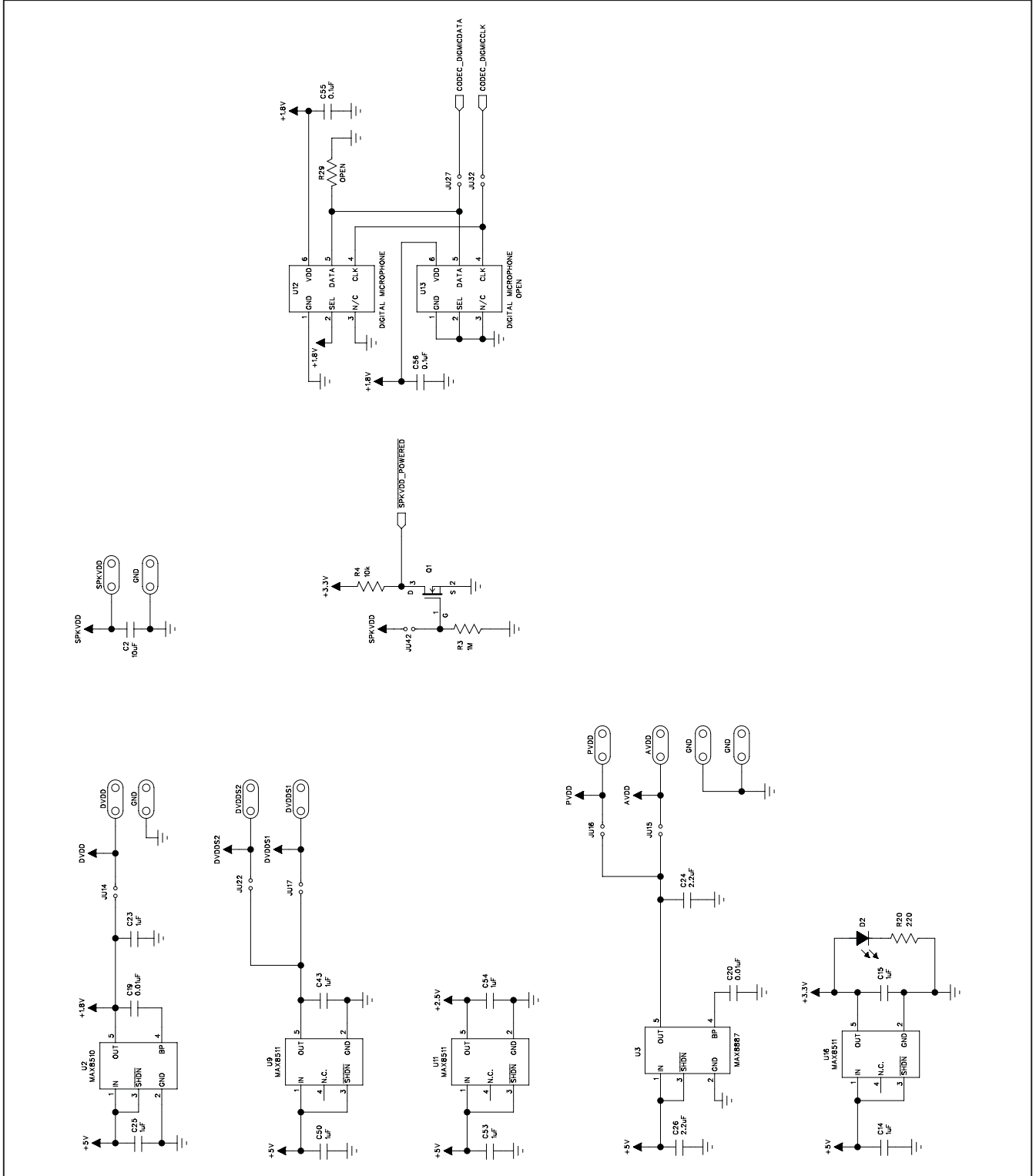

Figure 4e. MAX98088 EV Kit Schematic (Sheet 5 of 5)

# MAX98088 Evaluation Kit

Evaluates: MAX98088

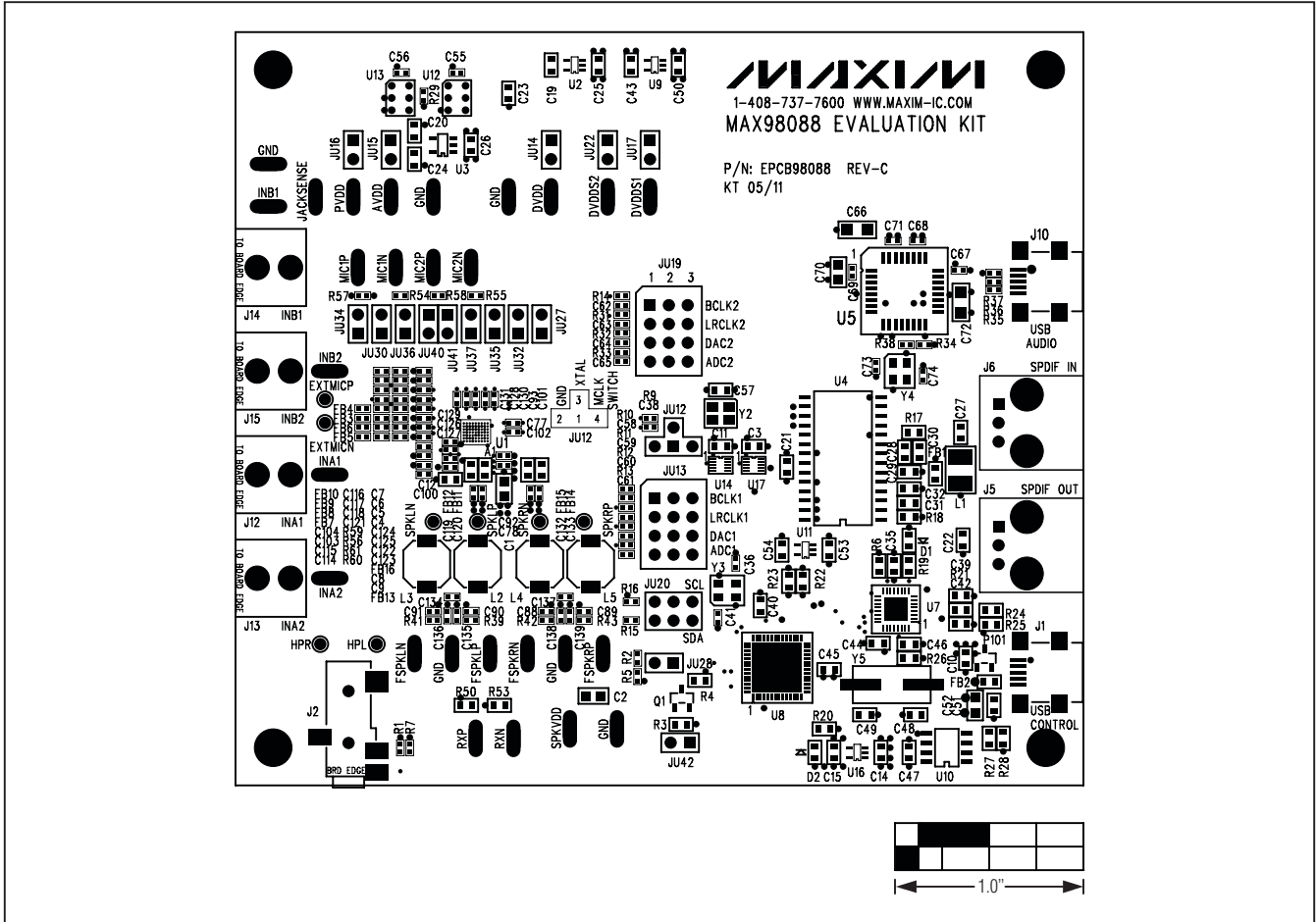

Figure 5. MAX98088 EV Kit Component Placement Guide—Component Side

# MAX98088 Evaluation Kit

Evaluates: MAX98088

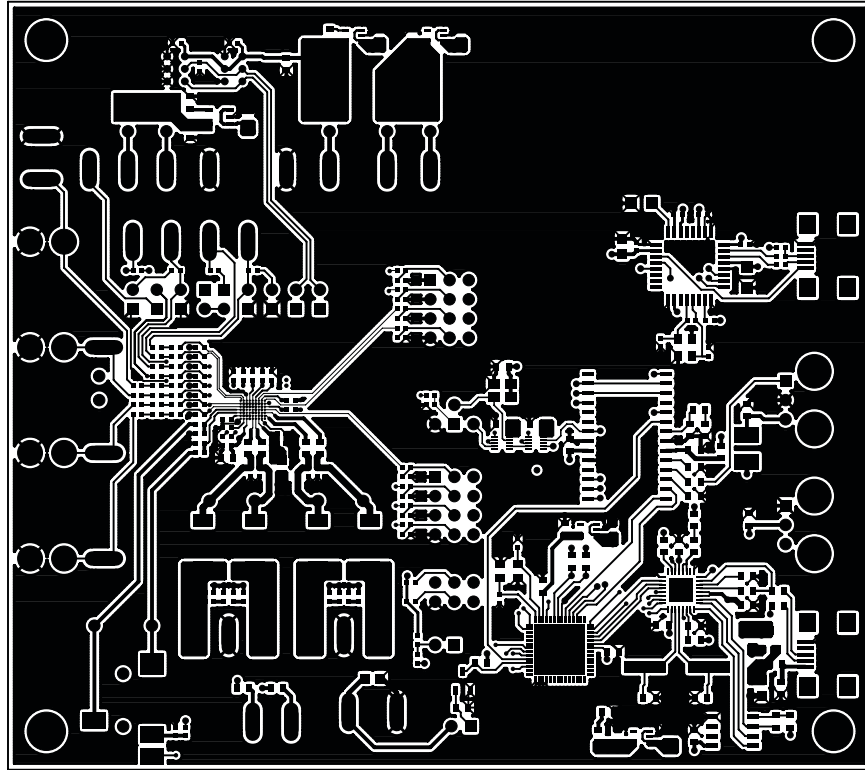

Figure 6. MAX98088 EV Kit PCB Layout—Component Side

# MAX98088 Evaluation Kit

Evaluates: MAX98088

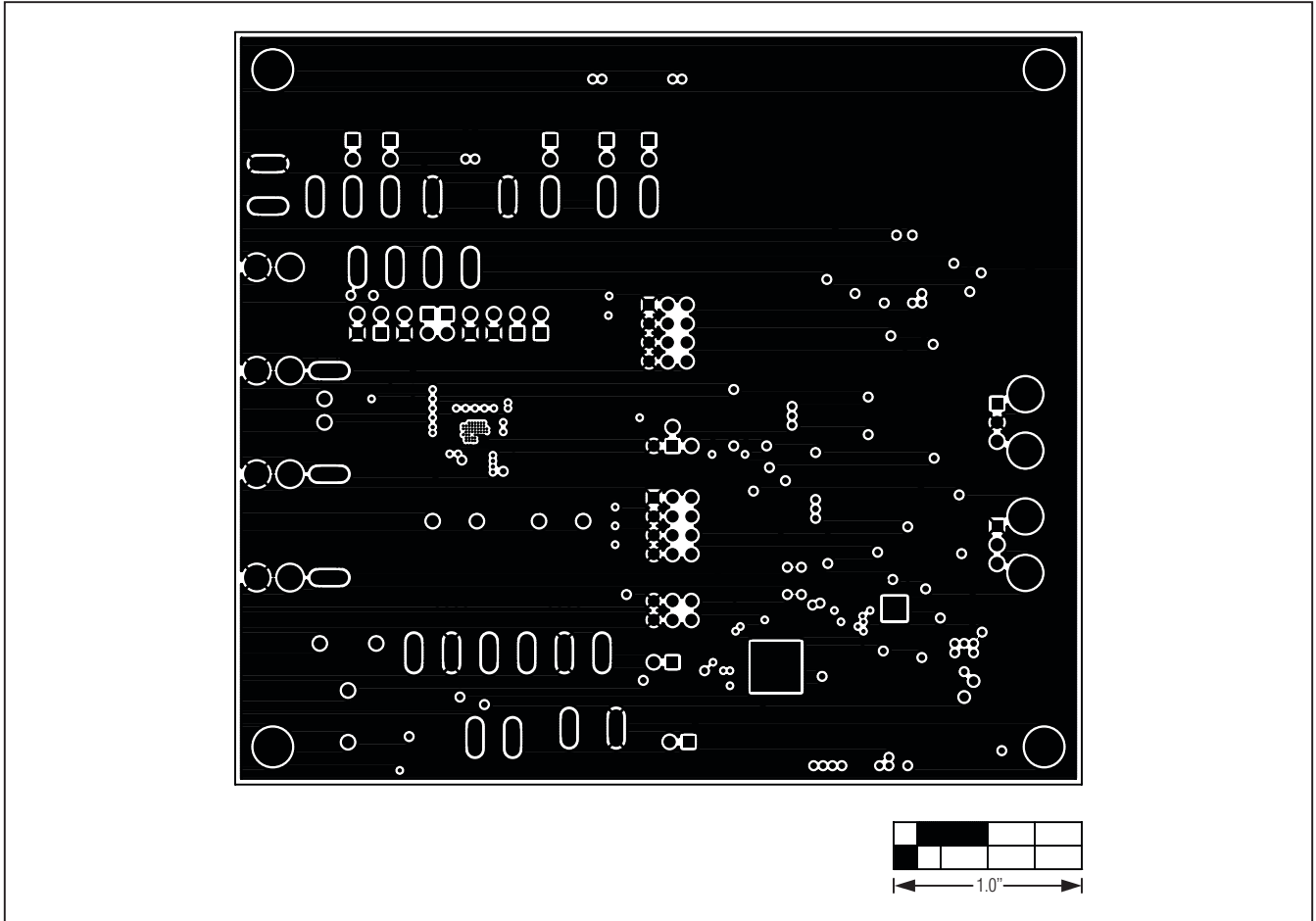

Figure 7. MAX98088 EV Kit PCB Layout—Ground Layer 2

# MAX98088 Evaluation Kit

Evaluates: MAX98088

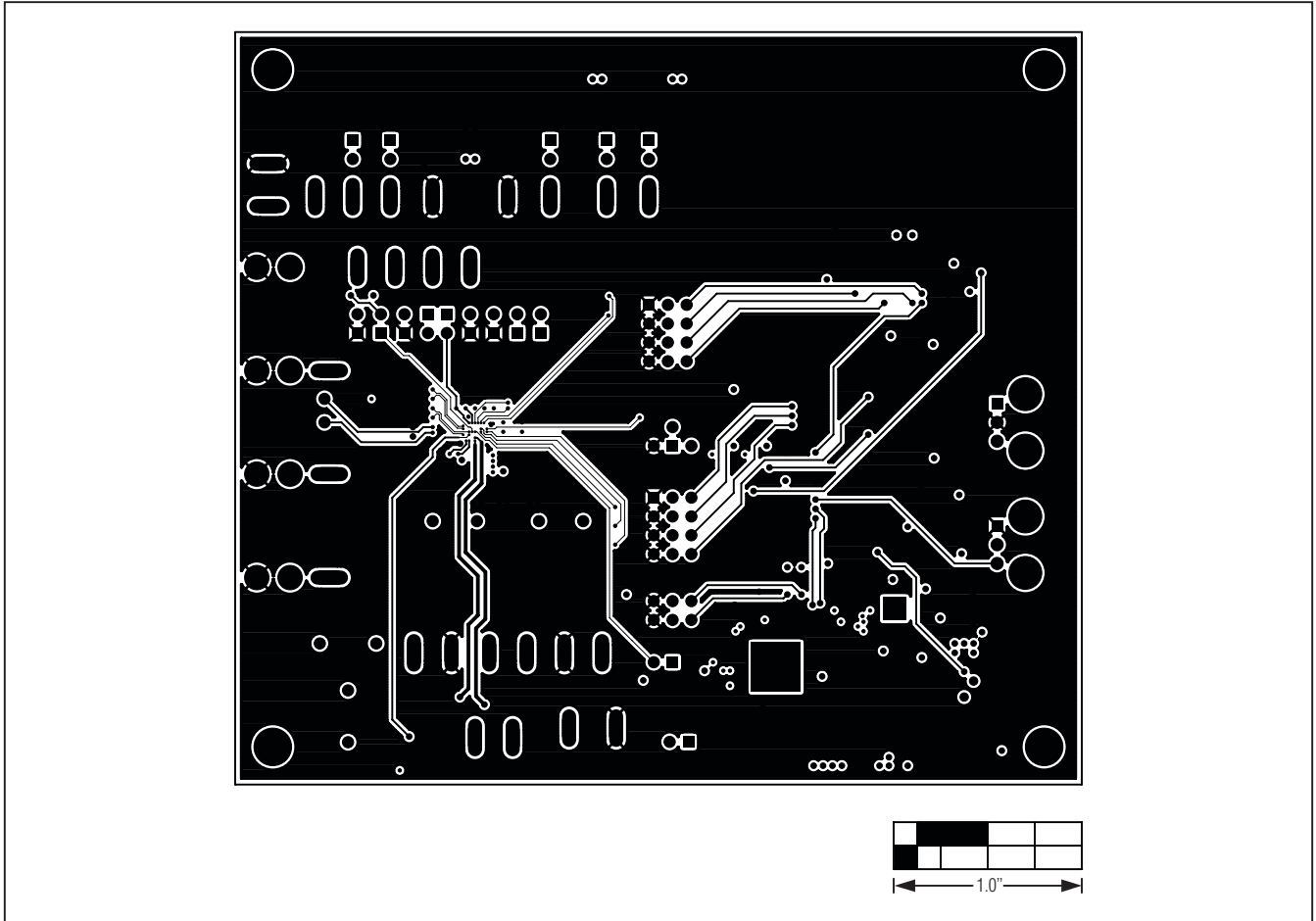

Figure 8. MAX98088 EV Kit PCB Layout—Ground Layer 3



# MAX98088 Evaluation Kit

Evaluates: MAX98088

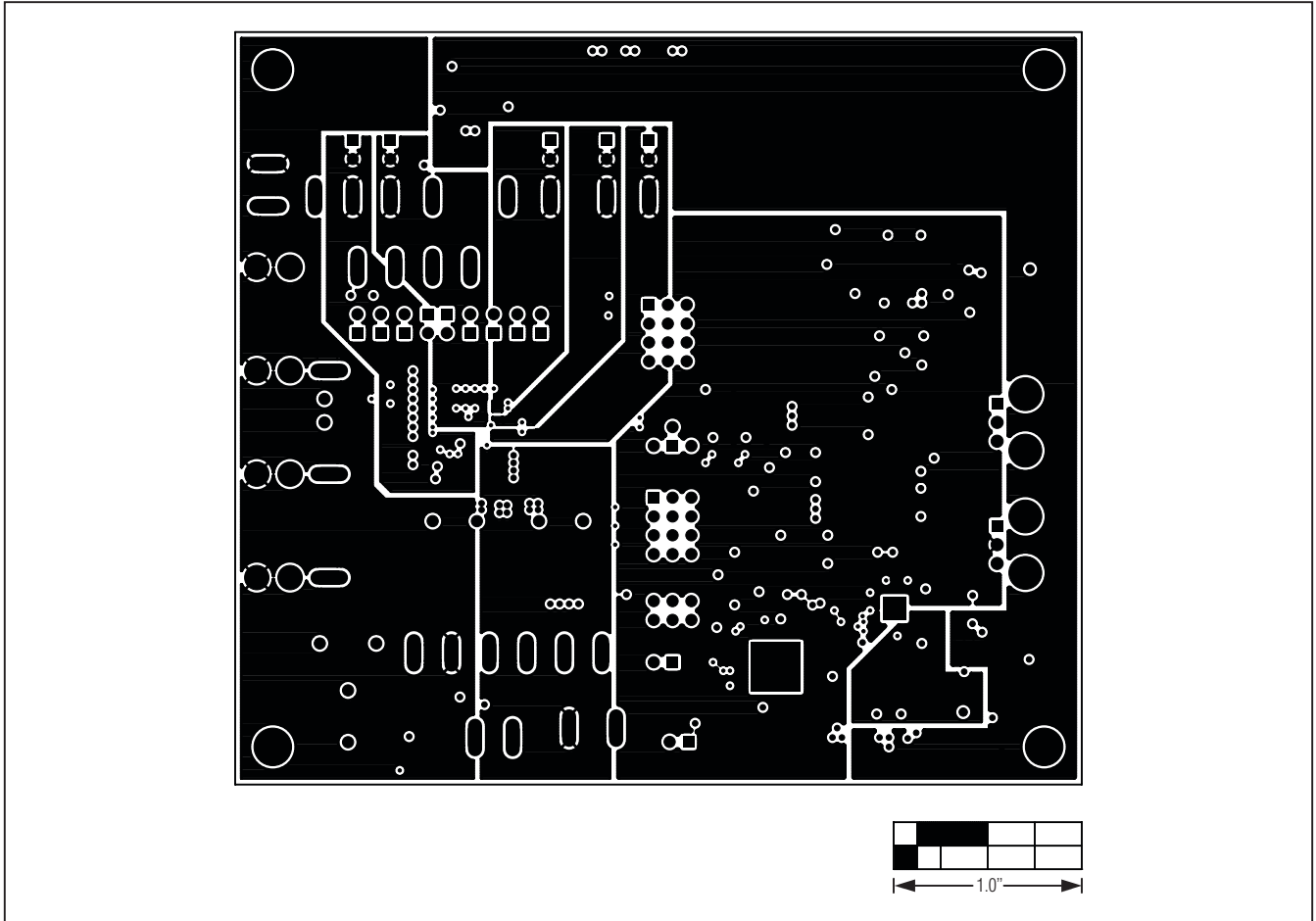

Figure 9. MAX98088 EV Kit PCB Layout—Power Layer 4

# MAX98088 Evaluation Kit

Evaluates: MAX98088

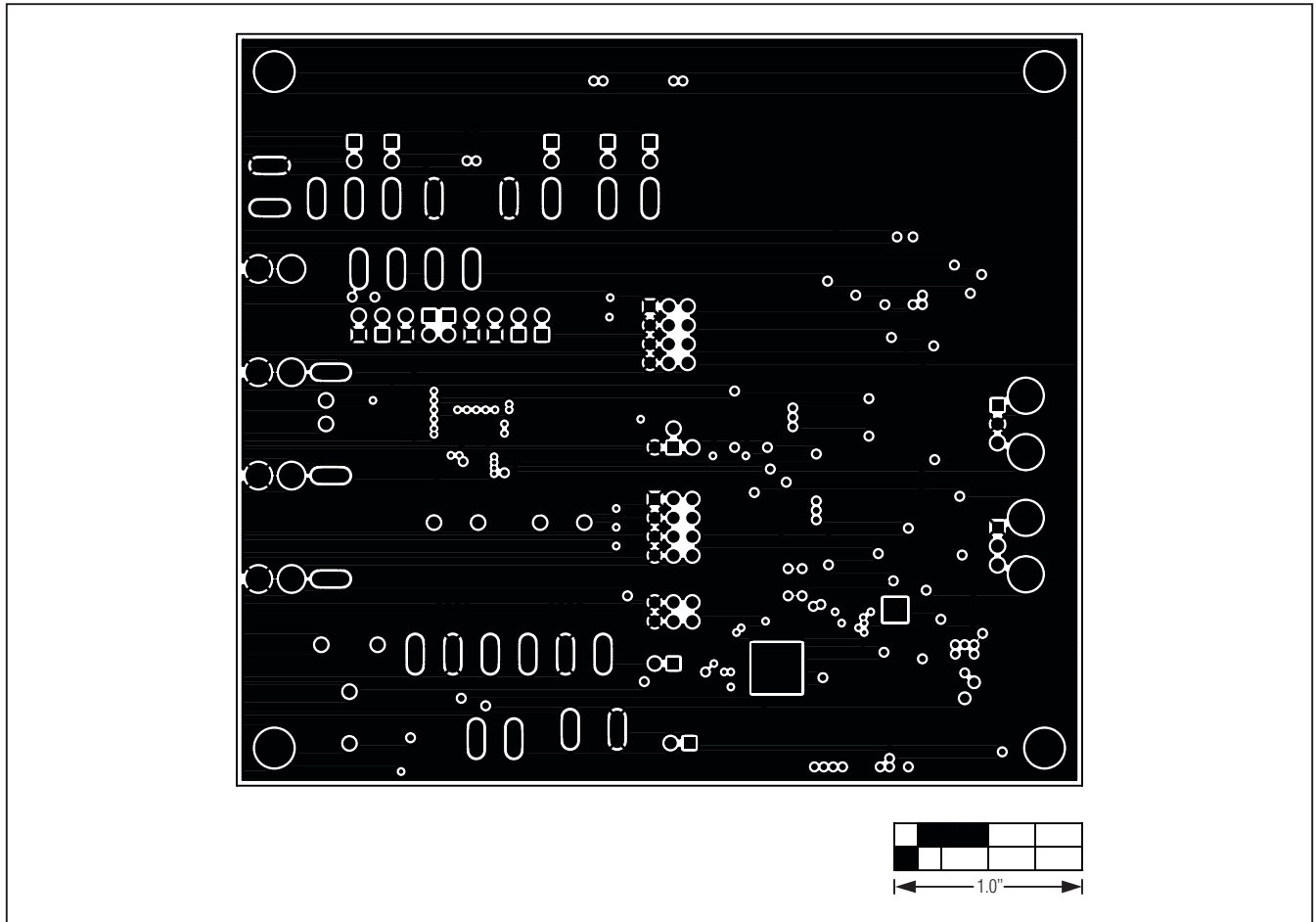

Figure 10. MAX98088 EV Kit PCB Layout—Ground Layer 5

# MAX98088 Evaluation Kit

Evaluates: MAX98088

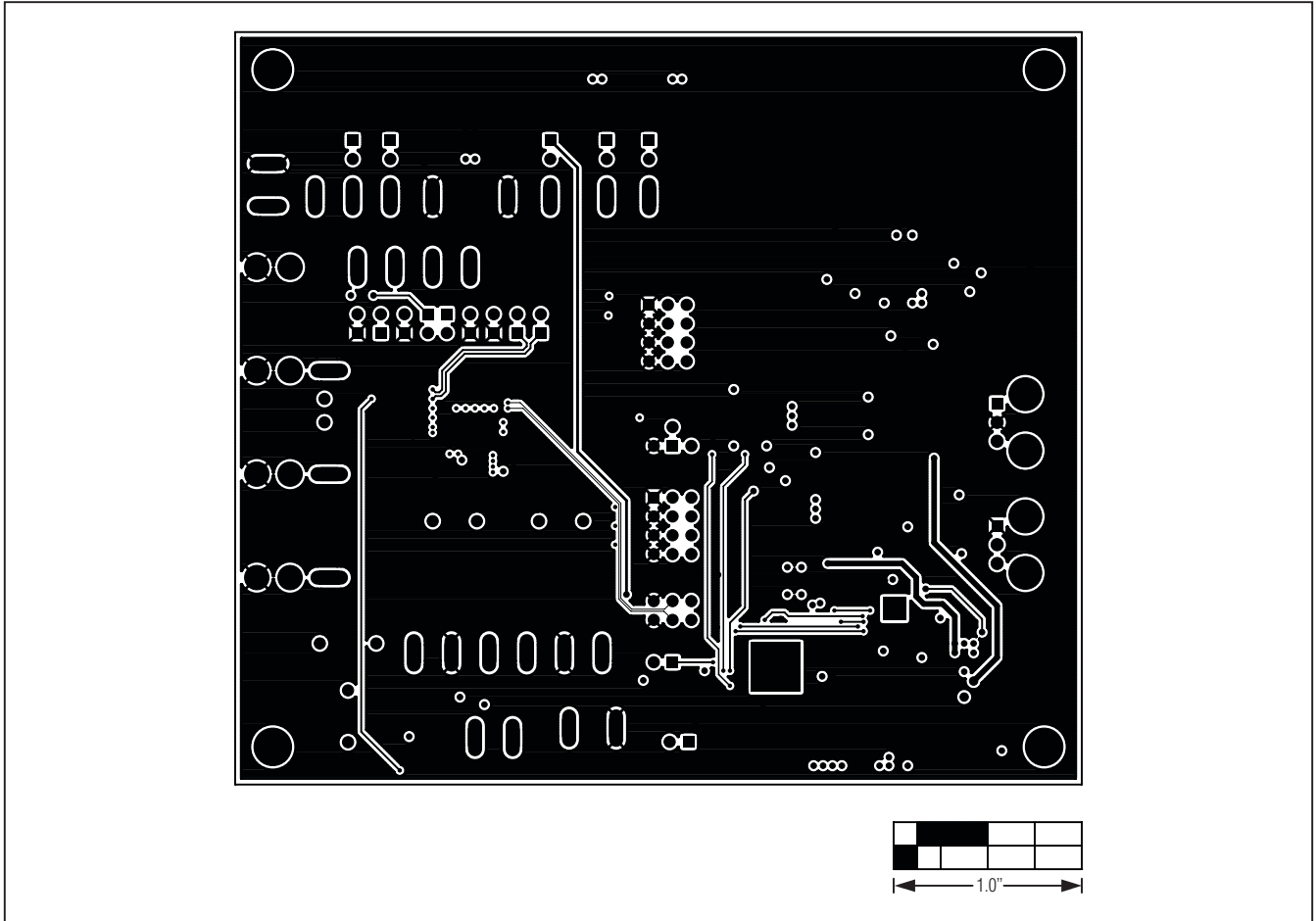

Figure 11. MAX98088 EV Kit PCB Layout—Solder Side

# MAX98088 Evaluation Kit

Evaluates: MAX98088

## Revision History

REVISION NUMBER	REVISION DATE	DESCRIPTION	PAGES CHANGED
0	8/10	Initial release	—
1	5/11	Added an alternate source for U12 and U13 components	3

Maxim cannot assume responsibility for use of any circuitry other than circuitry entirely embodied in a Maxim product. No circuit patent licenses are implied. Maxim reserves the right to change the circuitry and specifications without notice at any time.

24 **Maxim Integrated Products, 120 San Gabriel Drive, Sunnyvale, CA 94086 408-737-7600**

© 2011 Maxim Integrated Products

Maxim is a registered trademark of Maxim Integrated Products, Inc.