



1500 Watt Low Capacitance Surface Mount Transient Voltage Suppressor

Screening in reference to MIL-PRF-19500 available

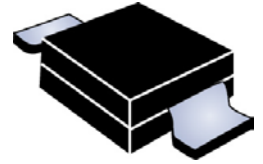
DESCRIPTION

This high-reliability surface mount Transient Voltage Suppressor (TVS) product family includes a rectifier diode in series with and in the opposite direction to the primary TVS protection diode. The circuit being protected sees only the rectifier diode's low 100 pF capacitance. They are available in either a DO-215AB (gull-wing) or DO-214AB (J-bend) package and RoHS compliant versions are available. The low capacitance of these TVS devices allows them to be applied to the protection of high-frequency signal and communication lines in inductive switching environments or systems exposed to the secondary effects of lightning per IEC61000-4-5 as well as RTCA/DO-160D or ARINC 429 for airborne avionics. They also protect from ESD and EFT per IEC61000-4-2 and IEC61000-4-4. If bipolar transient capability is required, two of these low capacitance TVS devices may be used in parallel and opposite directions (anti-parallel) for complete ac protection ([figure 6](#)).

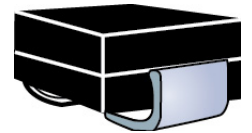
Important: For the latest information, visit our website <http://www.microsemi.com>.

FEATURES

- Available in standoff voltage range of 6.5 to 170 V.
- Low capacitance of 100 pF or less.
- Molding compound flammability rating: UL94V-O.
- Two different terminations available in C-bend (modified J-bend with DO-214AB) or Gull-wing (DO-215AB).
- Screening available in reference to MIL-PRF-19500. Refer to [High Reliability Up-Screened Plastic Products Portfolio](#) for more details on the screening options. (See [part nomenclature](#) for all available options.)
- RoHS compliant versions available.




**DO-215AB
(SMCG) Package**




**DO-214AB
(SMCJ) Package**

NOTE: All SMC series are equivalent to prior SMM package identifications.

Also available in:

Commercial grade
 [SMCG\(J\)LCE6.5 – SMCJ\(J\)LCE170Ae3](#)

Case 1 package
(axial-leaded)
 [MLCE6.5 – MLCE170Ae3](#)

APPLICATIONS / BENEFITS

- 1500 watts peak pulse power at 10/1000 μ s.
- Low capacitance for high frequency data line protection to 1 MHz.
- Protection for aircraft fast data rate lines up to level 5 waveform 4 and level 2 waveform 5A in RTCA/DO-160D (also see [MicroNote 130](#)) & ARINC 429 with bit rates of 100 kb/s (per ARINC 429, Part 1, par 2.4.1.1).
- IEC61000-4-2 ESD 15 kV (air), 8 kV (contact).
- IEC61000-4-5 (lightning) as further detailed in LCE6.5 thru LCE170A [data sheet](#).
- T1/E1 line cards.
- Base stations, WAN & XDSL interfaces.
- CSU/DSU equipment.

MSC – Lawrence

6 Lake Street,
Lawrence, MA 01841
Tel: 1-800-446-1158 or
(978) 620-2600
Fax: (978) 689-0803

MSC – Ireland

Gort Road Business Park,
Ennis, Co. Clare, Ireland
Tel: +353 (0) 65 6840044
Fax: +353 (0) 65 6822298

Website:

www.microsemi.com

MAXIMUM RATINGS @ 25 °C unless otherwise stated

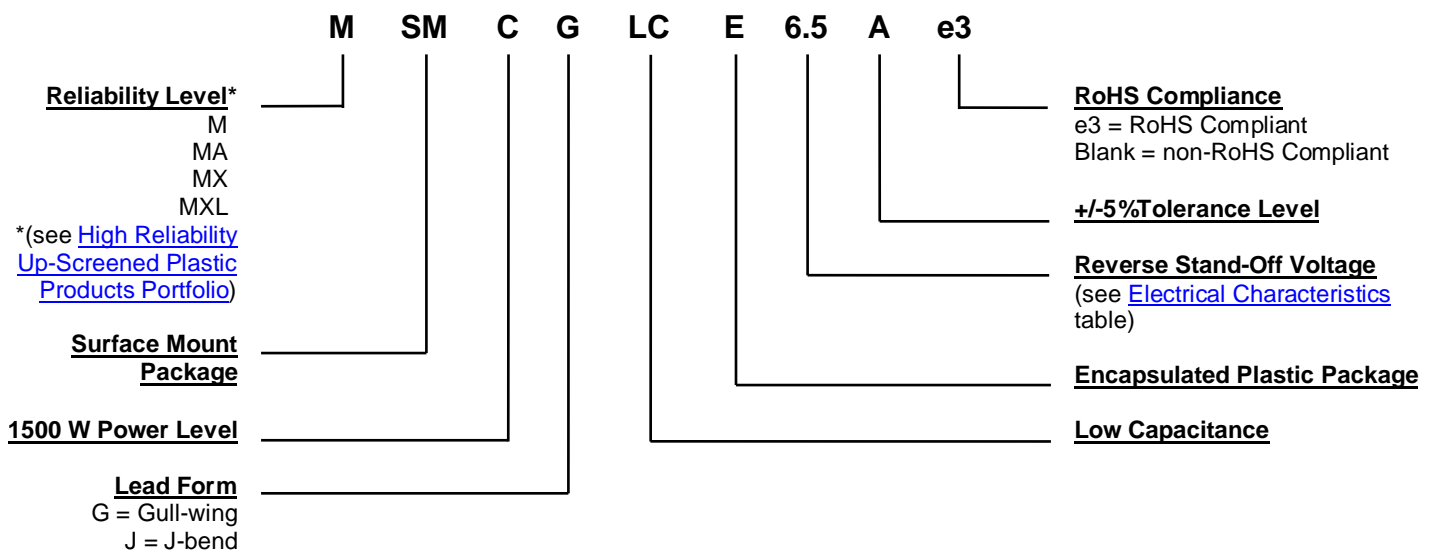
Parameters/Test Conditions	Symbol	Value	Unit
Junction and Storage Temperature	T _J and T _{STG}	-65 to +150	°C
Thermal Resistance Junction-to-Lead ⁽¹⁾	R _{θJL}	20	°C/W
Peak Pulse Power dissipation @ 25 °C (at 10/1000 μs, see figures 1, 2, and 3) ⁽²⁾	P _{PP}	1500	W
Clamping Factor	@ Full Rated Power	1.4	
	@ 50 % Rated Power	1.30	
t _{clamping} (0 volts to V _(BR) min.)	t _{clamping}	< 5x10 ⁻⁹	s
Rated Average Power Dissipation T _L = +50 °C	P _{M(AV)}	5.0	W
Solder Temperature @ 10 s	T _{SP}	260	°C

- Notes:**
1. Typical junction to lead (tab) at mounting plane.
 2. With a repetition rate of 0.01% or less. When pulse testing, do not pulse in opposite direction (see [“application schematics”](#) section herein and figures 5 & 6 for further protection in both directions.)

MECHANICAL and PACKAGING

- CASE: Void-free transfer molded thermosetting epoxy body meeting UL94V-0.
- TERMINALS: Tin-lead or RoHS compliant annealed matte-tin plating. Solderable to MIL-STD-750, method 2026.
- MARKING: Part number with abbreviated prefix (MCLC6.5A, MCLC6.5Ae3, MCLC33, MCLC33e3, etc.).
- POLARITY: Cathode indicated by band.
- TAPE & REEL option: Standard per EIA-481-B with 16 mm tape (add “TR” suffix to part number). Consult factory for quantities.
- WEIGHT: Approximately 0.25 grams.
- See [Package Dimensions](#) on last page.

PART NOMENCLATURE



SYMBOLS & DEFINITIONS

Symbol	Definition
$I_{(BR)}$	Breakdown Current: The current used for measuring breakdown voltage $V_{(BR)}$.
I_D	Standby Current: The current at the rated standoff voltage V_{WM} .
I_F	Forward Current: The forward current dc value, no alternating component.
I_O	Average Rectified Output Current: The output current averaged over a full cycle with a 50 Hz or 60 Hz sine-wave input and a 180 degree conduction angle.
I_{PP}	Peak Impulse Current: The peak current during the impulse.
P_{PP}	Peak Pulse Power: The peak power dissipation resulting from the peak impulse current I_{PP} .
V_C	Clamping Voltage: The maximum clamping voltage at specified I_{PP} (peak pulse current) at the specified pulse conditions.
$V_{(BR)}$	Minimum Breakdown Voltage: The minimum voltage the device will exhibit at a specified current.
V_{WM}	Working Peak Voltage: The maximum peak voltage that can be applied over the operating temperature range. This is also referred to as the standoff voltage.

ELECTRICAL CHARACTERISTICS @ 25 °C unless otherwise stated

Part Number		Reverse Stand-Off Voltage V_{WM}	Breakdown Voltage $V_{(BR)}$ @ $I_{(BR)}$			Maximum Reverse Leakage @ V_{WM} I_D	Maximum Clamping Voltage @ I_{PP} V_C	Maximum Peak Pulse Current I_{PP} @ 10/1000 Amps	Maximum Capacitance @ 0 Volts, $f = 1$ MHz	Working Inverse Blocking Voltage V_{WIB}	Inverse Blocking Leakage Current I_{IB}	Peak Inverse Blocking Voltage V_{PIB}
Gull-Wing	J-Bend		Volts	MIN	MAX							
MSMCG LCE6.5A	MSMCJLCE6.5A	6.5	7.22	7.98	10	1000	11.2	100	100	75	10	100
MSMCG LCE7.0A	MSMCJLCE7.0A	7.0	7.78	8.60	10	500	12.0	100	100	75	10	100
MSMCG LCE7.5A	MSMCJLCE7.5A	7.5	8.33	10.2	10	250	12.9	100	100	75	10	100
MSMCG LCE8.0A	MSMCJLCE8.0A	8.0	8.89	9.83	1	100	13.6	100	100	75	10	100
MSMCG LCE8.5A	MSMCJLCE8.5A	8.5	9.44	10.4	1	50	14.4	100	100	75	10	100
MSMCG LCE9.0A	MSMCJLCE9.0A	9.0	10.0	11.1	1	10	15.4	97	100	75	10	100
MSMCG LCE10A	MSMCJLCE10A	10	11.1	12.3	1	5	17.0	88	100	75	10	100
MSMCG LCE11A	MSMCJLCE11A	11	12.2	13.5	1	5	18.2	82	100	75	10	100
MSMCG LCE12A	MSMCJLCE12A	12	13.3	14.7	1	5	19.9	75	100	75	10	100
MSMCG LCE13A	MSMCJLCE13A	13	14.4	15.9	1	5	21.5	70	100	75	10	100
MSMCG LCE14A	MSMCJLCE14A	14	15.6	17.2	1	5	23.2	65	100	75	10	100
MSMCG LCE15A	MSMCJLCE15A	15	16.7	18.5	1	5	24.4	61	100	75	10	100
MSMCG LCE16A	MSMCJLCE16A	16	17.8	19.7	1	5	26.0	57	100	75	10	100
MSMCG LCE17A	MSMCJLCE17A	17	18.9	20.9	1	5	27.6	54	100	75	10	100
MSMCG LCE18A	MSMCJLCE18A	18	20.0	22.1	1	5	29.2	51	100	75	10	100
MSMCG LCE20A	MSMCJLCE20A	20	22.2	24.5	1	5	32.4	46	100	75	10	100
MSMCG LCE22A	MSMCJLCE22A	22	24.4	26.9	1	5	35.5	42	100	75	10	100
MSMCG LCE24A	MSMCJLCE24A	24	26.7	29.5	1	5	38.9	39	100	75	10	100
MSMCG LCE26A	MSMCJLCE26A	26	28.9	31.9	1	5	42.1	36	100	75	10	100
MSMCG LCE28A	MSMCJLCE28A	28	31.1	34.4	1	5	45.5	33	100	75	10	100
MSMCG LCE30A	MSMCJLCE30A	30	33.3	36.8	1	5	48.4	31	100	75	10	100
MSMCG LCE33A	MSMCJLCE33A	33	36.7	40.6	1	5	53.3	28.1	100	75	10	100
MSMCG LCE36A	MSMCJLCE36A	36	40.0	44.2	1	5	58.1	25.8	100	75	10	100
MSMCG LCE40A	MSMCJLCE40A	40	44.4	49.1	1	5	64.5	23.3	100	75	10	100
MSMCG LCE43A	MSMCJLCE43A	43	47.8	52.8	1	5	69.4	21.6	100	150	10	200
MSMCG LCE45A	MSMCJLCE45A	45	50.0	55.3	1	5	72.7	20.6	100	150	10	200
MSMCG LCE48A	MSMCJLCE48A	48	53.3	58.9	1	5	77.4	19.4	100	150	10	200
MSMCG LCE51A	MSMCJLCE51A	51	56.7	62.7	1	5	82.4	18.2	100	150	10	200
MSMCG LCE54A	MSMCJLCE54A	54	60.0	66.3	1	5	87.1	17.2	100	150	10	200
MSMCG LCE58A	MSMCJLCE58A	58	64.4	71.2	1	5	93.6	16.0	100	150	10	200
MSMCG LCE60A	MSMCJLCE60A	60	66.7	73.7	1	5	96.8	15.5	90	150	10	200
MSMCG LCE64A	MSMCJLCE64A	64	71.1	78.6	1	5	103	14.6	90	150	10	200
MSMCG LCE70A	MSMCJLCE70A	70	77.8	85.0	1	5	113	13.3	90	150	10	200
MSMCG LCE75A	MSMCJLCE75A	75	83.3	92.1	1	5	121	12.4	90	150	10	200
MSMCG LCE80A	MSMCJLCE80A	80	88.7	98.0	1	5	129	11.6	90	150	10	200
MSMCG LCE90A	MSMCJLCE90A	90	100	111	1	5	146	10.3	90	300	10	200
MSMCG LCE100A	MSMCJLCE100A	100	111	123	1	5	162	9.3	90	300	10	200
MSMCG LCE110A	MSMCJLCE110A	110	122	135	1	5	178	8.4	90	300	10	400
MSMCG LCE120A	MSMCJLCE120A	120	133	147	1	5	193	7.8	90	300	10	400
MSMCG LCE130A	MSMCJLCE130A	130	144	159	1	5	209	7.2	90	300	10	400
MSMCG LCE150A	MSMCJLCE150A	150	167	185	1	5	243	6.2	90	300	10	400
MSMCG LCE160A	MSMCJLCE160A	160	178	197	1	5	259	5.8	90	300	10	400
MSMCG LCE170A	MSMCJLCE170A	170	189	209	1	5	275	5.4	90	300	10	400

NOTE 1: TVS are normally selected according to the reverse standoff voltage" (V_{WM}) which should be equal to or greater than the dc or peak operating voltage level.

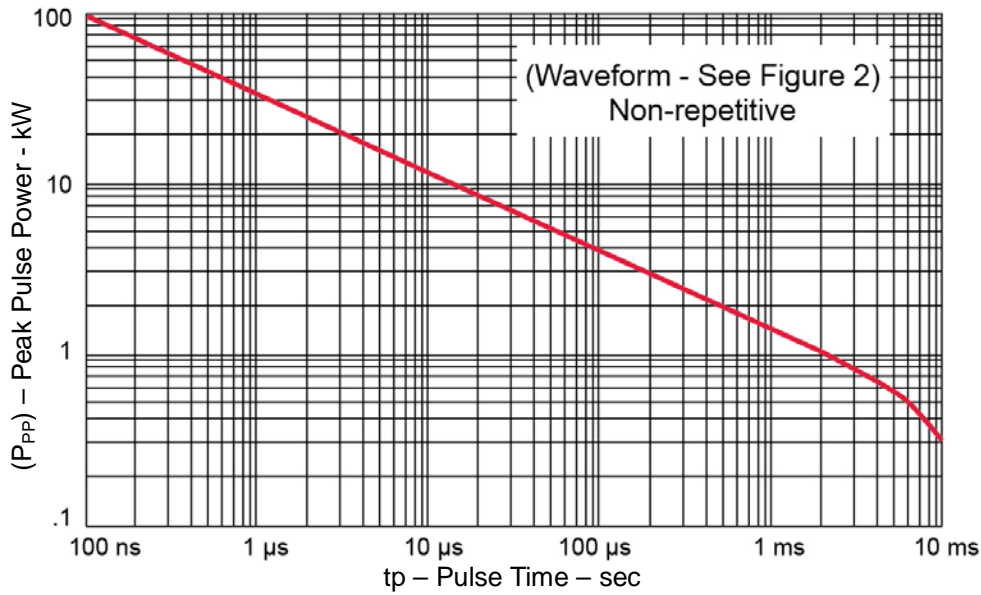
GRAPHS


FIGURE 1
Peak Pulse Power vs. Pulse Time

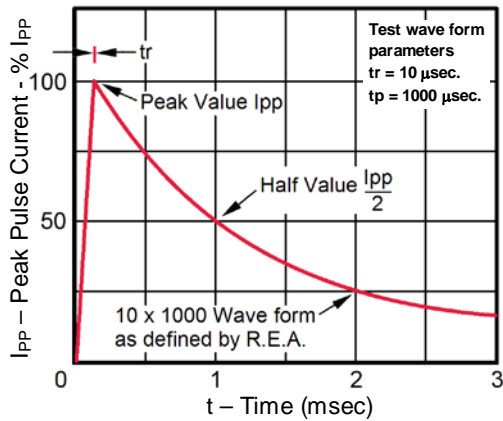


FIGURE 2
Pulse Waveform

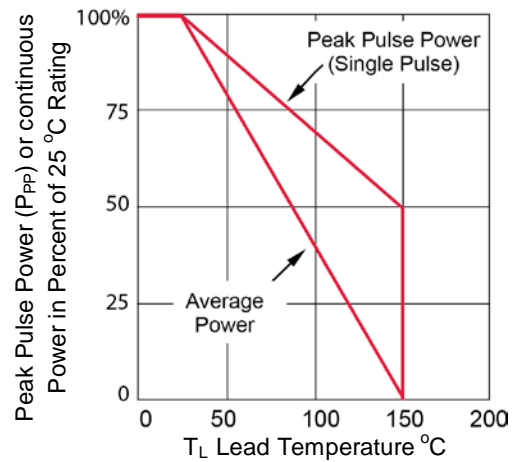


FIGURE 3
Derating Curve

APPLICATION SCHEMATICS

The TVS low capacitance device configuration is shown in figure 4. As a further option for unidirectional applications, an additional low capacitance rectifier diode may be used in parallel in the same polarity direction as the TVS as shown in figure 5. In applications where random high voltage transients occur, this will prevent reverse transients from damaging the internal low capacitance rectifier diode and also provide a low voltage conducting direction. The added rectifier diode should be of similar low capacitance and also have a higher reverse voltage rating than the TVS clamping voltage V_C . The Microsemi recommended rectifier part number for the application in figure 5 is the “SMBJLCR80” or “SMBGLCR80” depending on the terminal configuration desired. If using two (2) low capacitance TVS devices in anti-parallel for bidirectional applications, this added protective feature for both directions (including the reverse of each rectifier diode) is inherently provided in Figure 6. The unidirectional and bidirectional configurations in figure 5 and 6 will both result in twice the capacitance of figure 4.

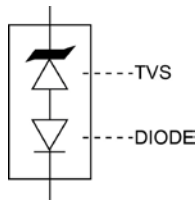


FIGURE 4
TVS with internal low capacitance rectifier diode

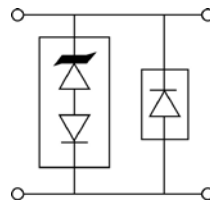


FIGURE 5
Optional Unidirectional configuration (TVS and separate rectifier diode in parallel)

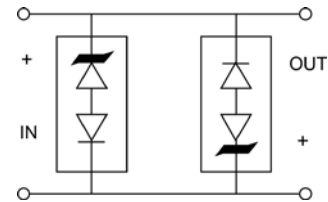
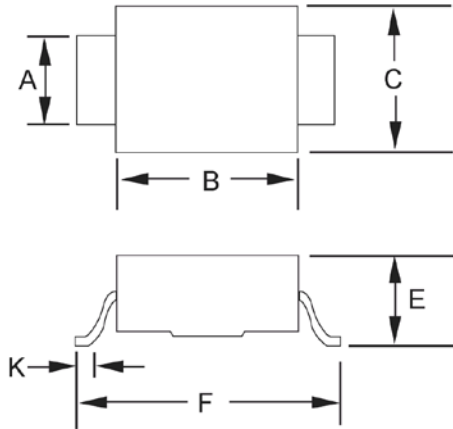
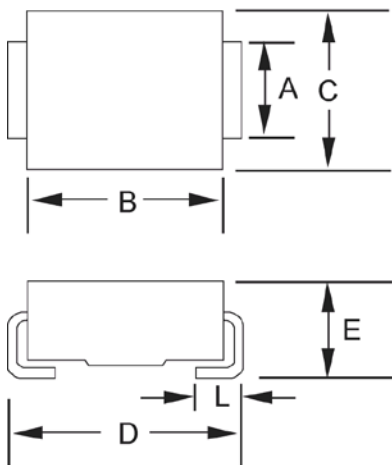


FIGURE 6
Optional Bidirectional configuration (two TVS devices in anti-parallel)

PACKAGE DIMENSIONS

SMCG (DO-215AB)

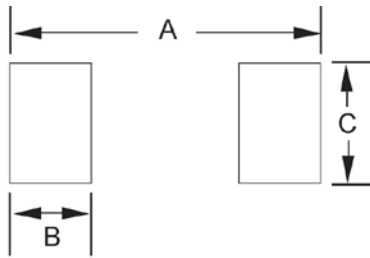
Ltr	Dimensions			
	Inch		Millimeters	
	Min	Max	Min	Max
A	.115	.121	2.92	3.07
B	.260	.280	6.60	7.11
C	.220	.245	5.59	6.22
E	.077	.110	1.95	2.80
F	.380	.400	9.65	10.16
K	.025	.040	0.635	1.016

NOTES: Dimension "E" exceeds the JEDEC outline as shown.
Typical Standoff Height: 0.004" – 0.008" (0.1 mm – 0.2 mm).


SMCJ (DO-214AB)

Ltr	Dimensions			
	Inch		Millimeters	
	Min	Max	Min	Max
A	.115	.121	2.92	3.07
B	.260	.280	6.60	7.11
C	.220	.245	5.59	6.22
D	.305	.320	7.75	8.13
E	.077	.110	1.95	2.80
L	.030	.060	.760	1.52

NOTES: Dimension "E" exceeds the JEDEC outline in height as shown.
Typical Standoff Height: 0.004" – 0.008" (0.1 mm – 0.2 mm).

PAD LAYOUT


SMCG (DO-215AB)		
Ltr	Inch	Millimeters
A	.510	12.95
B	.110	2.79
C	.150	3.81

SMCJ (DO-214AB)		
Ltr	Inch	Millimeters
A	.390	9.90
B	.110	2.79
C	.150	3.81