

Amphenol® MIL-DTL-5015 and MIL-5015 Type Standard Cylindrical Connectors

12-020-18



Amphenol

MS/Standard how to order

MIL-DTL-5015 and MIL-5015 Type (Solder Contacts)

MS 3102 A 18-3 P W (SR)
 1 2 3 4 5 6 7 8

1. Connector Type
 MS designates Military Standard
 CS* designates service class A and C with proprietary special contact arrangements
 SG* designates service class E with proprietary special contact arrangements
 SM* designates service class F and R with proprietary special contact arrangements
2. Connector Style
 3100 wall mounting receptacle
 3101 cable connecting plug
 3102 box mounting receptacle
 3106 straight plug
 3108 90° plug
3. Service Class
 A solid shell for general, non-environmental applications
 C solid shell for pressurized applications
 E environmental resisting
 F environmental resisting with strain relief (MS part number only)
 R lightweight environmental resisting
- 4., 5. Shell size and insert arrangement - see tables, pages 22-24.
6. Contact Types
 P designates pin contact
 S designates socket contact
7. Insert Rotation
 "W", "X", "Y", or "Z" designate that insert is rotated in its shell from normal position. No letter required for normal (no rotation) position.
8. (SR) strain relief for non-military connectors (For MS use "F" class)

* For insert arrangements over 50 and shell size 40 and above.
 Exceptions: 36-52, 40-1, 40-9 and 40-56 are MS approved.

Consult Amphenol, Sidney, NY for availability of alternate finishes, including black and olive drab zinc alloys.

Proprietary (Crimp Contacts)

75 - 68 0 12-3 H
 1 2 3 4 5 6

1. Connector Type
 75 – connector utilizing silver plated contacts
 80 – less contacts
 85 – contacts utilizing 50 micro-inches gold over silver plating
2. Service Class
 68 service class A, general duty
 474 service class F, environmental resisting
 190 service class R, lightweight environmental resisting
3. Connector Style
 0 wall mounting receptacle
 1 cable connecting plug
 2 box mounting receptacle
 6 straight plug
 8 90° plug
4. Shell Size Designator

| | | | | | | | | | | |
|------------------|----|-----|------|-----|----|-----|----|-----|----|----|
| Shell Size | 8S | 10S | 10SL | 12S | 12 | 14S | 14 | 16S | 16 | 18 |
| Shell Designator | 8 | 10 | 11 | 12 | 13 | 14 | 15 | 16 | 17 | 18 |

| | | | | | | | | | | |
|------------------|----|----|----|----|----|----|----|----|----|--|
| Shell Size | 20 | 22 | 24 | 28 | 32 | 36 | 40 | 44 | 48 | |
| Shell Designator | 20 | 22 | 24 | 28 | 32 | 36 | 40 | 44 | 48 | |

5. Insert Arrangements
 See page 22-24.
6. Contact Type/Alternate Insert Rotation
 P designates pin, S designates socket for normal positioning of inserts. When an alternate position of the connector insert is required to prevent cross-mating, a different letter (other than P or S) is used. See page 25 for description of alternate positions, then convert to Amphenol® proprietary coding by the following charts:

| Pin Contacts | | Socket Contacts | |
|--------------|-----------------|-----------------|-----------------|
| MS Letter | Amphenol Letter | MS Letter | Amphenol Letter |
| PW | G | SW | H |
| PX | I | SX | J |
| PY | K | SY | L |
| PZ | M | SZ | N |

Amphenol® MIL-DTL-5015 and MIL-5015 Type Standard Cylindrical Connectors



MS-A, MS-C



MS-E/F



MS-R

DESIGN CHARACTERISTICS

- Medium to heavy weight cylindrical
- Durable, field-proven design
- Environmental resistant
- Resilient inserts
- Operating voltage to 3000 VAC (RMS) at sea level
- Threaded couplings
- Single key/keyway shell polarization
- Cost effective

CUSTOMER OPTIONS

- Five shell styles
- Nineteen shell sizes
- 305 contact arrangements from 1 to 104 circuits
- Solder or crimp contacts, sizes 16-0 accepting 22-0 AWG.
- Coaxial and thermocouple contact options
- Five class designations
- Alternate insert positioning
- Hermetic configurations available
- Zinc alloy plating (cadmium-free) available

MS connectors meet the latest performance requirements of MIL-DTL-5015. These connectors represent well-proven electrical capability at an acceptable cost for most equipment where durability is important.

MIL-DTL-5015 features threaded couplings and single key/keyway polarization, representing maximum simplicity in design. Applications include military ground support equipment, ordnance and shipboard installations.

Amphenol Industrial Operations manufactures five classes of connectors to meet different requirements. Class designations and brief descriptions are listed below.

A – Solid Shell – for general, non-environmental applications.

C – Pressurized – for use on pressurized bulkheads or pressure barriers; limits air leakage regardless of type and class of plug mated with them.

E/F – Environmental Resisting with Strain Relief – designed for applications where the connector will be exposed to moisture, vibration, and rapid changes in pressure and temperature.

R – Lightweight Environmental Resisting – shorter in length and lighter in weight than the E and F classes, the MS-R offers a high degree of reliability under adverse conditions: recommended for new design applications.

MS/Standard MS-A and MS-C



wall mounting receptacle



cable connecting plug



box mounting receptacle



straight plug

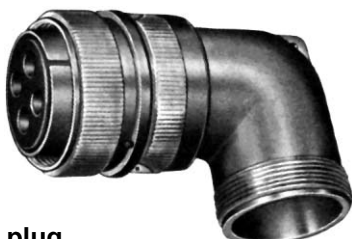

90 degree plug

MS-A and MS-C

MS-A and MS-C class connectors perform many of the vital functions in powering, testing and ground support systems. Class A applications include communications equipment, computers and shipboard installations where mechanical forces and physical parameters are not subject to extreme or rapid environmental changes.

Class C connectors are most frequently used on pressurized bulkheads or pressure barriers at elevated altitudes or maritime applications. Air leakage is limited to one cubic inch per hour at a pressure differential of 30 lbs. per square inch.

Shells:

Shell components are fabricated from high grade aluminum alloy. Electrically conductive cadmium plate finish with an olive drab chromate after-treat offers corrosion resistance.

Contacts:

Contacts are available in both solder and crimp versions. Pins and sockets are machined from copper alloy with a silver plated finish. Size 16 and 12 socket contacts incorporate a closed entry design. Refer to pages 49, 67 and 68 for additional contact information.

Inserts:

Inserts are resilient neoprene, offering high dielectric strength, high arc resistance and resistance to vibration. Proprietary design permits pressurization of either pin or socket insert.

MS/Standard MS3100A or C wall mounting receptacle



To complete order number, see "how to order" pg. 70.
For solder well data, see page 67.

| Shell Size | A Thread Class 2A | B Min Full Thread | K +.020 - .010 | L ±.030 | M +.010 - .000 | R ±.005 | S ±.031 | T Dia. +.004 - .002 | V Thread Class 2A | Z +.050 - .060 |
|------------|-------------------|-------------------|----------------|---------|----------------|---------|---------|---------------------|-------------------|----------------|
| 8S | .5000-28UNEF | .391 | .672 | 1.391 | .562 | .594 | .875 | .120 | .5000-28UNEF | .422 |
| 10S | .6250-24 UNF | .391 | .672 | 1.468 | .562 | .719 | 1.000 | .120 | .5000-28UNEF | .422 |
| 10SL | .6250-24 UNF | .391 | .672 | 1.468 | .562 | .719 | 1.000 | .120 | .6250-24NEF | .422 |
| 12S | .7500-20UNEF | .450 | .672 | 1.468 | .562 | .812 | 1.094 | .120 | .6250-24NEF | .422 |
| 12 | .7500-20UNEF | .625 | .860 | 1.843 | .750 | .812 | 1.094 | .120 | .6250-24NEF | .672 |
| 14S | .8750-20UNEF | .450 | .672 | 1.468 | .562 | .906 | 1.188 | .120 | .7500-20UNEF | .422 |
| 14 | .8750-20UNEF | .625 | .860 | 1.843 | .750 | .906 | 1.188 | .120 | .7500-20UNEF | .672 |
| 16S | 1.0000-20UNEF | .450 | .672 | 1.468 | .562 | .969 | 1.281 | .120 | .8750-20UNEF | .422 |
| 16 | 1.0000-20UNEF | .625 | .860 | 1.843 | .750 | .969 | 1.281 | .120 | .8750-20UNEF | .672 |
| 18 | 1.1250-18NEF | .625 | .891 | 1.938 | .750 | 1.063 | 1.375 | .120 | 1.0000-20UNEF | .641* |
| 20 | 1.2500-18NEF | .625 | .891 | 1.844 | .750 | 1.156 | 1.500 | .120 | 1.1875-18NEF | .641* |
| 22 | 1.3750-18NEF | .625 | .891 | 1.938 | .750 | 1.250 | 1.625 | .120 | 1.1875-18NEF | .641* |
| 24 | 1.5000-18NEF | .625 | .953 | 1.969 | .812 | 1.375 | 1.750 | .147 | 1.4375-18NEF | .578* |
| 28 | 1.7500-18NS | .625 | .953 | 2.188 | .812 | 1.562 | 2.000 | .147 | 1.4375-18NEF | .578* |
| 32 | 2.0000-18NS | .625 | 1.031 | 2.157 | .875 | 1.750 | 2.250 | .173 | 1.7500-18NS | .500* |
| 36 | 2.2500-16UN | .625 | 1.031 | 2.219 | .875 | 1.938 | 2.500 | .173 | 2.0000-18NS | .500* |
| 40 | 2.5000-16UN | .625 | 1.031 | 2.188 | .875 | 2.188 | 2.750 | .173 | 2.2500-16UN | .500* |
| 44*** | 2.7500-16UN | .625 | 1.031† | 2.547 | .875 | 2.375 | 3.000†† | .173 | 2.5000-16UN | .751** |
| 48*** | 3.0000-16UN | .625 | 1.031† | 2.547 | .875 | 2.625 | 3.000†† | .173 | 3.0000-16UN | .751** |

* Increase Z dimension by .312 for size "0" contact only.
** Increase Z dimension by .062 for size "0" contact only.
*** Available in proprietary version only.
† +.020 -.030
†† ±.020

MS/Standard MS3101A cable connecting plug



To complete order number, see "how to order" pg. 70.
For solder well data, see page 67.

| Shell Size | A Thread Class 2A | B Min. Full Thread | L $\pm .030$ | N Dia. Max. | V Thread Class 2A | Z $\pm .040$ |
|------------|-------------------|--------------------|--------------|-------------|-------------------|--------------|
| 8S | .5000-28UNEF | .406 | 1.390 | .532 | .5000-28UNEF | 1.094 |
| 10S | .6250-24NEF | .406 | 1.468 | .628 | .5000-28UNEF | 1.094 |
| 10SL | .6250-24NEF | .406 | 1.468 | .755 | .6250-24NEF | 1.094 |
| 12S | .7500-20UNEF | .422 | 1.468 | .755 | .6250-24NEF | 1.094 |
| 12 | .7500-20UNEF | .656 | 1.843 | .755 | .6250-24NEF | 1.532 |
| 14S | .8750-20UNEF | .391 | 1.468 | .882 | .7500-20UNEF | 1.094 |
| 14 | .8750-20UNEF | .625 | 1.843 | .882 | .7500-20UNEF | 1.532 |
| 16S | 1.0000-20UNEF | .391 | 1.468 | 1.010 | .8750-20UNEF | 1.094 |
| 16 | 1.0000-20UNEF | .625 | 1.843 | 1.010 | .8750-20UNEF | 1.532 |
| 18 | 1.1250-18NEF | .625 | 1.938 | 1.137 | 1.0000-20UNEF | 1.532* |
| 20 | 1.2500-18NEF | .625 | 1.844 | 1.264 | 1.1875-18NEF | 1.532* |
| 22 | 1.3750-18NEF | .625 | 1.938 | 1.392 | 1.1875-18NEF | 1.532* |
| 24 | 1.5000-18NEF | .625 | 1.969 | 1.519 | 1.4375-18NEF | 1.532* |
| 28 | 1.7500-18NS | .625 | 2.188 | 1.774 | 1.4375-18NEF | 1.532* |
| 32 | 2.0000-18NS | .625 | 2.157 | 1.996 | 1.7500-18NS | 1.532* |
| 36 | 2.2500-16UN | .625 | 2.219 | 2.251 | 2.0000-18NS | 1.532* |
| 40 | 2.5000-16UN | .625 | 2.188 | 2.506 | 2.2500-16UN | 1.532* |
| 44*** | 2.7500-16UN | .625 | 2.521 | 3.135 | 2.5000-16UN | 1.782** |

* Increase Z dimension by .312 for size "0" contact only.

** Increase Z dimension by .062 for size "0" contact only.

*** Available in proprietary version only.

MS/Standard MS3102A or C box mounting receptacle

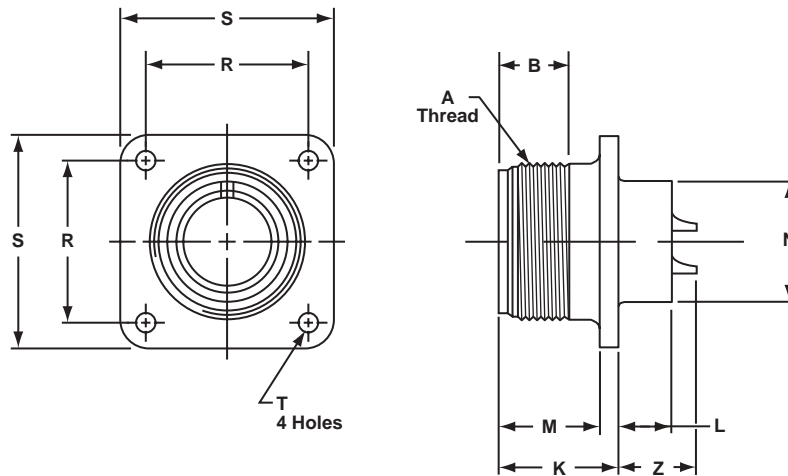

To complete order number, see "how to order" pg. 70.
For solder well data, see page 67.

| Shell Size | A Thread Class 2A | B Min Full Thread | K +.020 - .010 | L +.000 - .010 | M +.010 - .000 | N Dia. +.010 - .000 | R ±.005 | S ±.031 | T Dia. +.004 - .002 | Z +.050 - .060 |
|------------|-------------------|-------------------|----------------|----------------|----------------|---------------------|---------|---------|---------------------|----------------|
| 8S | .5000-28UNEF | .391 | .672 | .297 | .562 | .375 | .594 | .875 | .120 | .422 |
| 10S | .6250-24NEF | .391 | .672 | .297 | .562 | .500 | .719 | 1.000 | .120 | .422 |
| 10SL | .6250-24NEF | .391 | .672 | .297 | .562 | .625 | .719 | 1.000 | .120 | .422 |
| 12S | .7500-20UNEF | .450 | .672 | .297 | .562 | .625 | .812 | 1.094 | .120 | .422 |
| 12 | .7500-20UNEF | .625 | .860 | .484 | .750 | .625 | .812 | 1.094 | .120 | .672 |
| 14S | .8750-20UNEF | .450 | .672 | .297 | .562 | .750 | .906 | 1.188 | .120 | .422 |
| 14 | .8750-20UNEF | .625 | .860 | .484 | .750 | .750 | .906 | 1.188 | .120 | .672 |
| 16S | 1.0000-20UNEF | .450 | .672 | .297 | .562 | .875 | .969 | 1.281 | .120 | .422 |
| 16 | 1.0000-20UNEF | .625 | .860 | .484 | .750 | .875 | .969 | 1.281 | .120 | .672 |
| 18 | 1.1250-18NEF | .625 | .891 | .453 | .750 | 1.000 | 1.062 | 1.375 | .120 | .641* |
| 20 | 1.2500-18NEF | .625 | .891 | .453 | .750 | 1.125 | 1.156 | 1.500 | .120 | .641* |
| 22 | 1.3750-18NEF | .625 | .891 | .453 | .750 | 1.250 | 1.250 | 1.625 | .120 | .641* |
| 24 | 1.5000-18NEF | .625 | .953 | .453 | .812 | 1.375 | 1.375 | 1.750 | .147 | .578 |
| 28 | 1.7500-18NS | .625 | .953 | .453 | .812 | 1.625 | 1.562 | 2.000 | .147 | .578* |
| 32 | 2.0000-18NS | .625 | 1.031 | .438 | .875 | 1.875 | 1.750 | 2.250 | .173 | .500* |
| 36 | 2.2500-16UN | .625 | 1.031 | .438 | .875 | 2.062 | 1.938 | 2.500 | .173 | .500* |
| 40 | 2.5000-16UN | .625 | 1.031 | .438 | .875 | 2.312 | 2.188 | 2.750 | .173 | .500* |
| 44*** | 2.7500-16UN | .625 | 1.063 | .543† | .875 | 2.594 | 2.375 | 3.000†† | .173 | .768** |
| 48*** | 3.0000-16UN | .625 | 1.063 | .543† | .875 | 2.812 | 2.625 | 3.250†† | .209 | .769** |

* Increase Z dimension by .312 for size "0" contact only.
** Increase Z dimension by .062 for size "0" contact only.
*** Available in proprietary version only.
† +.020 -.030
†† ±.020

MS/Standard MS3106A straight plug



To complete order number, see "how to order" pg. 70.
For solder well data, see page 67.
All lockwire holes are .045 dia. min.

| Shell Size | A Thread Class 2B | J ±.005 | L ±.030 | Q Dia. Max. | V Thread Class 2A | Z ±.045 |
|------------|-------------------|---------|---------|-------------|-------------------|---------|
| 8S | .5000-28UNEF | .531 | .859 | .741 | .5000-28UNEF | .562 |
| 10S | .6250-24NEF | .531 | .937 | .869 | .5000-28UNEF | .562 |
| 10SL | .6250-24NEF | .531 | .937 | .946 | .6250-24NEF | .562 |
| 12S | .7500-20UNEF | .531 | .937 | .995 | .6250-24NEF | .562 |
| 12 | .7500-20UNEF | .719 | 1.124 | .995 | .6250-24NEF | .812 |
| 14S | .8750-20UNEF | .531 | .937 | 1.123 | .7500-20UNEF | .562 |
| 14 | .8750-20UNEF | .719 | 1.124 | 1.123 | .7500-20UNEF | .812 |
| 16S | 1.0000-20UNEF | .531 | .937 | 1.250 | .8750-20UNEF | .562 |
| 16 | 1.0000-20UNEF | .719 | 1.124 | 1.250 | .8750-20UNEF | .812 |
| 18 | 1.1250-18NEF | .719 | 1.219 | 1.333 | 1.0000-20UNEF | .812* |
| 20 | 1.2500-18NEF | .719 | 1.125 | 1.461 | 1.1875-18NEF | .812* |
| 22 | 1.3750-18NEF | .719 | 1.219 | 1.588 | 1.1875-18NEF | .812* |
| 24 | 1.5000-18NEF | .719 | 1.251 | 1.715 | 1.4375-18NEF | .812* |
| 28 | 1.7500-18NS | .719 | 1.470 | 1.968 | 1.4375-18NEF | .812* |
| 32 | 2.0000-18NS | .719 | 1.439 | 2.209 | 1.7500-18NS | .812* |
| 36 | 2.2500-16UN | .719 | 1.500 | 2.463 | 2.0000-18NS | .812* |
| 40 | 2.5000-16UN | .719 | 1.469 | 2.719 | 2.2500-16UN | .812* |
| 44*** | 2.7500-16UN | .719 | 1.818† | 3.084 | 2.5000-16UN | 1.063** |
| 48*** | 3.3000-16UN | .719 | 1.818† | 3.354 | 3.0000-16UN | 1.063** |

* Increase Z dimension by .312 for size "0" contact only.

** Increase Z dimension by .062 for size "0" contact only.

*** Available in proprietary version only.

† +.020 -.030

MS/Standard MS3108A 90 degree plug



To complete order number, see "how to order" pg. 70.
For solder well data, see page 67.
All lockwire holes are .045 dia. min.

| Shell Size | A Thread Class 2B | J $\pm .005$ | L Max. | Q Dia. Max. | U Max. | V Thread Class 2A | W | Z $\pm .045$ |
|------------|-------------------|--------------|--------|-------------|--------|-------------------|------|--------------|
| 8S | .5000-28UNEF | .531 | .896 | .741 | .750 | .5000-28UNEF | .375 | .562 |
| 10S | .6250-24NEF | .531 | .927 | .869 | .750 | .5000-28UNEF | .375 | .562 |
| 10SL | .6250-24NEF | .531 | .951 | .946 | .875 | .6250-24NEF | .375 | .562 |
| 12S | .7500-20UNEF | .531 | .956 | .995 | .875 | .6250-24NEF | .375 | .562 |
| 12 | .7500-20UNEF | .719 | 1.143 | .995 | .875 | .6250-24NEF | .375 | .812 |
| 14S | .8750-20UNEF | .531 | 1.120 | 1.123 | 1.000 | .7500-20UNEF | .375 | .562 |
| 14 | .8750-20UNEF | .719 | 1.207 | 1.123 | 1.000 | .7500-20UNEF | .375 | .812 |
| 16S | 1.0000-20UNEF | .531 | 1.146 | 1.250 | 1.062 | .8750-20UNEF | .375 | .562 |
| 16 | 1.0000-20UNEF | .719 | 1.332 | 1.250 | 1.062 | .8750-20UNEF | .375 | .812 |
| 18 | 1.1250-18NEF | .719 | 1.395 | 1.333 | 1.188 | 1.0000-20UNEF | .375 | .812* |
| 20 | 1.2500-18NEF | .719 | 1.645 | 1.461 | 1.250 | 1.1875-18NEF | .375 | .812* |
| 22 | 1.3750-18NEF | .719 | 1.645 | 1.588 | 1.312 | 1.1875-18NEF | .375 | .812* |
| 24 | 1.5000-18NEF | .719 | 1.896 | 1.715 | 1.438 | 1.4375-18NEF | .375 | .812* |
| 28 | 1.7500-18NS | .719 | 1.896 | 1.968 | 1.500 | 1.4375-18NEF | .375 | .812* |
| 32 | 2.0000-18NS | .719 | 2.118 | 2.209 | 1.750 | 1.7500-18NS | .438 | .812* |
| 36 | 2.2500-16UN | .719 | 2.176 | 2.463 | 1.875 | 2.0000-18NS | .500 | .812* |
| 40 | 2.5000-16UN | .719 | 2.301 | 2.719 | 2.031 | 2.2500-16UN | .500 | .812* |

* Increase Z dimension by .312 for size "0" contact only.

MS/Standard MS-E/F



wall mounting receptacle



cable connecting plug



box mounting receptacle



straight plug



90 degree plug

MS-E & F

MS Class F connectors satisfy all the performance requirements of MIL-DTL-5015. Class E, environmental is also produced, but is no longer listed on the qualified products listing (QPL). These connectors are recommended for conditions where vibration, moisture, pressure and/or temperature are extreme. Strain relief is supplied on most shell sizes.

Shells:

Shell components are fabricated from high grade aluminum alloy. The standard hardware plating is electrically conductive cadmium plated finish with an olive drab chromate after-treatment for corrosion resistance. Consult Amphenol, Sidney, NY for other plating options.

Contacts:

Contacts are silver plated copper alloy for maximum corrosion resistance, maximum current carrying capacity and low millivolt drop. Size 16 and 12 socket contacts incorporate a closed entry design. Crimp and solder versions are available. Refer to pages 49, 67 and 68 for additional contact information.

Inserts:

Resilient neoprene inserts provide an outstanding moisture barrier, high dielectric strength, and resistance to vibration. Either pin or socket insert can be pressurized.

Strain Relief Clamp:

Strain relief clamps minimize tension at the solder well connection and provide a positive mechanical moisture seal. Complete field serviceability is possible with the strain relief clamp.

MS/Standard MS3100E/F wall mounting receptacle



To complete order number, see "how to order" pg. 70.
For solder well data, see page 67.

| Shell Size | A Thread Class 2A | B Min. Full Thread | K $+0.020$ -0.010 | L Max. | M $+0.010$ -0.000 | P Max. | R ± 0.005 | S ± 0.010 | T Dia. $+0.004$ -0.002 | Z* Max. | XX Min. Cable Clearance |
|------------|-------------------|--------------------|---------------------|--------|---------------------|--------|---------------|---------------|--------------------------|---------|-------------------------|
| 10SL | .6250-24UNEF | .391 | .672 | 2.129 | .562 | .896 | .719 | 1.000 | .120 | .472 | .281 |
| 12S | .7500-20UNEF | .450 | .672 | 2.129 | .562 | .896 | .812 | 1.094 | .120 | .472 | .281 |
| 12 | .7500-20UNEF | .625 | .860 | 2.129 | .750 | .896 | .812 | 1.094 | .120 | .722 | .281 |
| 14S | .8750-20UNEF | .450 | .672 | 2.201 | .562 | 1.021 | .906 | 1.188 | .120 | .472 | .406 |
| 14 | .8750-20UNEF | .625 | .860 | 2.524 | .750 | 1.021 | .906 | 1.188 | .120 | .722 | .406 |
| 16S | 1.0000-20UNEF | .450 | .672 | 2.201 | .562 | 1.151 | .969 | 1.281 | .120 | .472 | .500 |
| 16 | 1.0000-20UNEF | .625 | .860 | 2.524 | .750 | 1.151 | .969 | 1.281 | .120 | .722 | .500 |
| 18 | 1.1250-18UNEF | .625 | .891 | 2.596 | .750 | 1.242 | 1.063 | 1.375 | .120 | .691 | .531 |
| 20 | 1.2500-18UNEF | .625 | .891 | 2.654 | .750 | 1.499 | 1.156 | 1.500 | .120 | .691 | .656 |
| 22 | 1.3750-18UNEF | .625 | .891 | 2.654 | .750 | 1.499 | 1.250 | 1.625 | .120 | .691 | .740 |
| 24 | 1.5000-18UNEF | .625 | .953 | 2.885 | .812 | 1.781 | 1.375 | 1.750 | .147 | .628 | .781 |
| 28 | 1.7500-18UNS | .625 | .953 | 2.885 | .812 | 1.781 | 1.562 | 2.000 | .147 | .628 | .922 |
| 32 | 2.0000-18UNS | .625 | 1.031 | 2.943 | .875 | 2.087 | 1.750 | 2.250 | .173 | .550 | 1.156 |
| 36 | 2.2500-16UN | .625 | 1.031 | 2.943 | .875 | 2.281 | 1.938 | 2.500 | .173 | .550 | 1.250 |
| 40 | 2.5000-16UN | .625 | 1.031 | 3.068 | .875 | 2.581 | 2.188 | 2.750 | .173 | .550 | 1.562 |

* Increase Z dimension by .312 for size "0" contact only.

MS/Standard MS3101E/F cable connecting plug



To complete order number, see "how to order" pg. 70.
For solder well data, see page 67.

| Shell Size | A Thread Class 2A | B Min. Full Thread | J Max. | L Max. | Z* Max. | XX Min. Cable Clearance |
|------------|-------------------|--------------------|--------|--------|---------|-------------------------|
| 10SL | .6250-24UNEF | .406 | .896 | 2.129 | 1.134 | .281 |
| 12S | .7500-20UNEF | .422 | .896 | 2.129 | 1.134 | .281 |
| 12 | .7500-20UNEF | .656 | .896 | 2.129 | 1.572 | .281 |
| 14S | .8750-20UNEF | .391 | 1.021 | 2.201 | 1.134 | .406 |
| 14 | .8750-20UNEF | .625 | 1.021 | 2.524 | 1.572 | .406 |
| 16S | 1.0000-20UNEF | .391 | 1.151 | 2.201 | 1.134 | .500 |
| 16 | 1.0000-20UNEF | .625 | 1.151 | 2.524 | 1.572 | .500 |
| 18 | 1.1250-18UNEF | .625 | 1.242 | 2.596 | 1.572 | .531 |
| 20 | 1.2500-18UNEF | .625 | 1.499 | 2.654 | 1.572 | .656 |
| 22 | 1.3750-18UNEF | .625 | 1.499 | 2.654 | 1.572 | .740 |
| 24 | 1.5000-18UNEF | .625 | 1.781 | 2.885 | 1.572 | .781 |
| 28 | 1.7500-18UNS | .625 | 1.781 | 2.885 | 1.572 | .922 |
| 32 | 2.0000-18UNS | .625 | 2.087 | 2.943 | 1.572 | 1.156 |
| 36 | 2.2500-16UN | .625 | 2.281 | 2.943 | 1.572 | 1.250 |
| 40 | 2.5000-16UN | .625 | 2.581 | 3.068 | 1.572 | 1.562 |

* Increase Z dimension by .312 for size "0" contact only.

MS/Standard MS3102E box mounting receptacle

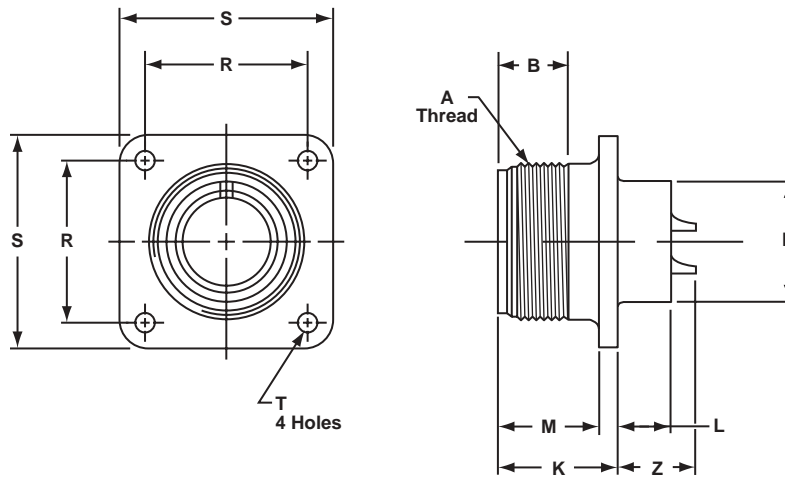

To complete order number, see "how to order" pg. 70.
For solder well data, see page 67.

| Shell Size | A Thread Class 2A | B Min. Full Thread | K $+0.020$ -0.010 | L $+0.000$ -0.010 | M $+0.010$ -0.000 | N Dia. $+0.010$ -0.000 | R ± 0.005 | S ± 0.031 | T Dia. $+0.004$ -0.002 | Z $+0.050$ -0.060 |
|------------|-------------------|--------------------|---------------------|---------------------|---------------------|--------------------------|---------------|---------------|--------------------------|---------------------|
| 8S | .5000-28UNEF | .391 | .672 | .297 | .562 | .375 | .594 | .875 | .120 | .422 |
| 10S | .6250-24NEF | .391 | .672 | .297 | .562 | .500 | .719 | 1.000 | .120 | .422 |
| 10SL | .6250-24NEF | .391 | .672 | .297 | .562 | .625 | .719 | 1.000 | .120 | .422 |
| 12S | .7500-20UNEF | .450 | .672 | .297 | .562 | .625 | .812 | 1.094 | .120 | .422 |
| 12 | .7500-20UNEF | .625 | .860 | .484 | .750 | .625 | .812 | 1.094 | .120 | .672 |
| 14S | .8750-20UNEF | .450 | .672 | .297 | .562 | .750 | .906 | 1.188 | .120 | .422 |
| 14 | .8750-20UNEF | .625 | .860 | .484 | .750 | .750 | .906 | 1.188 | .120 | .672 |
| 16S | 1.0000-20UNEF | .450 | .672 | .297 | .562 | .875 | .969 | 1.281 | .120 | .422 |
| 16 | 1.0000-20UNEF | .625 | .860 | .484 | .750 | .875 | .969 | 1.281 | .120 | .672 |
| 18 | 1.1250-18NEF | .625 | .891 | .453 | .750 | 1.000 | 1.062 | 1.375 | .120 | .641* |
| 20 | 1.2500-18NEF | .625 | .891 | .453 | .750 | 1.125 | 1.156 | 1.500 | .120 | .641* |
| 22 | 1.3750-18NEF | .625 | .891 | .453 | .750 | 1.250 | 1.250 | 1.625 | .120 | .641* |
| 24 | 1.5000-18NEF | .625 | .953 | .453 | .812 | 1.375 | 1.375 | 1.750 | .147 | .578* |
| 28 | 1.7500-18NS | .625 | .953 | .453 | .812 | 1.625 | 1.562 | 2.000 | .147 | .578* |
| 32 | 2.0000-18NS | .625 | 1.031 | .438 | .875 | 1.875 | 1.750 | 2.250 | .173 | .500* |
| 36 | 2.2500-16UN | .625 | 1.031 | .438 | .875 | 2.062 | 1.938 | 2.500 | .173 | .500* |
| 40 | 2.5000-16UN | .625 | 1.031 | .438 | .875 | 2.312 | 2.188 | 2.750 | .173 | .500* |

* Increase Z dimension by .312 for size "0" contact only.

MS/Standard MS3106E/F straight plug



To complete order number, see "how to order" pg. 70.
For solder well data, see page 67.
All lockwire holes are .045 dia. min.

| Shell Size | A Thread Class 2A | B ±.005 | J Max. | L Max. | Q Max. | Z* ±.045 | XX Min. Cable Clearance |
|------------|-------------------|---------|--------|--------|--------|----------|-------------------------|
| 10SL | .6250-24UNEF | .531 | .896 | 2.129 | .946 | .607 | .281 |
| 12S | .7500-20UNEF | .531 | .896 | 2.129 | .995 | .607 | .281 |
| 12 | .7500-20UNEF | .719 | .896 | 2.129 | .995 | .857 | .281 |
| 14S | .8750-20UNEF | .531 | 1.021 | 2.201 | 1.123 | .607 | .406 |
| 14 | .8750-20UNEF | .719 | 1.021 | 2.524 | 1.123 | .857 | .406 |
| 16S | 1.0000-20UNEF | .531 | 1.151 | 2.201 | 1.250 | .607 | .500 |
| 16 | 1.0000-20UNEF | .719 | 1.151 | 2.524 | 1.250 | .857 | .500 |
| 18 | 1.1250-18UNEF | .719 | 1.242 | 2.596 | 1.333 | .857 | .531 |
| 20 | 1.2500-18UNEF | .719 | 1.499 | 2.654 | 1.461 | .857 | .656 |
| 22 | 1.3750-18UNEF | .719 | 1.499 | 2.654 | 1.588 | .857 | .740 |
| 24 | 1.5000-18UNEF | .719 | 1.781 | 2.885 | 1.715 | .857 | .781 |
| 28 | 1.7500-18UNS | .719 | 1.781 | 2.885 | 1.968 | .857 | .922 |
| 32 | 2.0000-18UNS | .719 | 2.087 | 2.943 | 2.209 | .857 | 1.156 |
| 36 | 2.2500-16UN | .719 | 2.281 | 2.943 | 2.463 | .857 | 1.250 |
| 40 | 2.5000-16UN | .719 | 2.581 | 3.068 | 2.718 | .857 | 1.562 |

* Increase Z dimension by .312 for size "0" contact only.

MS/Standard MS3108E 90 degree plug



To complete order number, see "how to order" pg. 70.
For solder well data, see page 67.
All lockwire holes are .045 dia. min.

| Shell Size | A Thread Class 2B | J ±.005 | L Max. | N Max. | Q Dia. Max. | U Max. | Y Thread Class 2B | Z ±.045 |
|------------|-------------------|---------|--------|--------|-------------|--------|-------------------|---------|
| 8S | .5000-28UNEF | .531 | .927 | .807 | .741 | 1.445 | 6-32NC | .562 |
| 10S | .6250-24NEF | .531 | .927 | .807 | .869 | 1.445 | 6-32NC | .562 |
| 10SL | .6250-24NEF | .531 | .951 | .901 | .946 | 1.508 | 6-32NC | .562 |
| 12S | .7500-20UNEF | .531 | .956 | .901 | .995 | 1.508 | 6-32NC | .562 |
| 12 | .7500-20UNEF | .719 | 1.143 | .901 | .995 | 1.508 | 6-32NC | .812 |
| 14S | .8750-20UNEF | .531 | 1.020 | 1.026 | 1.123 | 1.570 | 6-32NC | .562 |
| 14 | .8750-20UNEF | .719 | 1.207 | 1.026 | 1.123 | 1.570 | 6-32NC | .812 |
| 16S | 1.0000-20UNEF | .531 | 1.146 | 1.119 | 1.250 | 1.633 | 6-32NC | .562 |
| 16 | 1.1000-20UNEF | .719 | 1.333 | 1.119 | 1.250 | 1.633 | 6-32NC | .812 |
| 18 | 1.1250-18NEF | .719 | 1.395 | 1.229 | 1.333 | 1.759 | 6-32NC | .812* |
| 20 | 1.2500-18NEF | .719 | 1.598 | 1.479 | 1.461 | 1.931 | 8-32NC | .812* |
| 22 | 1.3750-18NEF | .719 | 1.598 | 1.479 | 1.588 | 1.993 | 8-32NC | .812* |
| 24 | 1.5000-18NEF | .719 | 1.786 | 1.666 | 1.729 | 2.119 | 8-32NC | .812* |
| 28 | 1.7500-18NS | .719 | 1.786 | 1.666 | 1.968 | 2.181 | 8-32NC | .812* |
| 32 | 2.0000-18NS | .719 | 2.020 | 2.135 | 2.209 | 2.570 | 10-32NF | .812* |
| 36 | 2.2500-16UN | .719 | 2.145 | 2.260 | 2.463 | 2.695 | 10-32NF | .812* |
| 40 | 2.5000-16UN | .719 | 2.270 | 2.510 | 2.719 | 2.851 | 10-32NF | .812* |

* Increase Z dimension by .312 for size "0" contact only.

MS/Standard MS-R



wall mounting receptacle



cable connecting plug



box mounting receptacle



straight plug

MS-R

Specification requirements for greater reliability in a shorter, lighter weight environmental resistant connector led to the design of the MS-R. MS Class R connectors satisfy all the performance requirements of MIL-DTL-5015.

This low profile assembly was attained by moving the axial compression nut and grommet assembly forward and flush with the rear of the insert. The neoprene grommet, with its low coefficient of friction, assures easier threading of wire bundles and quicker assembly and serviceability of the unit. Molded webs in each wire hole insure a moisture barrier around each wire.

The addition of an "O" ring at the main joint of all MS3106R plugs provide a main joint seal supplementary to the interfacial seal, thus insuring a higher degree of reliability when connector halves from different sources are employed. MS-R types are recommended for new design applications.

Shells:

Shell components are fabricated from high grade aluminum alloy. All components have the standard electrically conductive cadmium plated finish with an olive drab chromate after-treatment for corrosion resistance. Consult Amphenol, Sidney, NY for other plating options.

Contacts:

Contacts are machined from copper alloy for maximum corrosion resistance, maximum current carrying capacity and low millivolt drop. Both crimp and solder versions are available. Refer to pages 49, 67 and 68 for additional contact information.

Inserts:

Resilient neoprene inserts provide an outstanding moisture barrier, maximum vibration resistance and high dielectric strength. Either pin or socket insert can be pressurized.

MS/Standard MS3100R wall mounting receptacle



To complete order number, see "how to order" pg. 70.
For solder well data, see page 67.
All lockwire holes are .045 dia. min.

| Shell Size | A Thread Class 2A | B Min. Full Thread | H Dia. Max. | K +.020 -0.010 | L Max. | M +.010 -0.000 | P Dia. Max. | R ±.005 | S ±.031 | Y Thread Class 2 | T Dia. +.004 -0.002 | Z +.050 -0.060 |
|------------|-------------------|--------------------|-------------|----------------|--------|----------------|-------------|---------|---------|------------------|---------------------|----------------|
| 8S | .5000-28UNEF | .391 | .959 | .672 | 1.588 | .562 | .557 | .594 | .875 | 6-32NC | .120 | .422 |
| 10S | .6250-24NEF | .391 | 1.026 | .672 | 1.588 | .562 | .682 | .719 | 1.000 | 6-32NC | .120 | .422 |
| 10SL | .6250-24NEF | .391 | 1.120 | .672 | 1.588 | .562 | .807 | .719 | 1.000 | 6-32NC | .120 | .422 |
| 12S | .7500-20UNEF | .450 | 1.120 | .672 | 1.588 | .562 | .807 | .812 | 1.094 | 6-32NC | .120 | .422 |
| 12 | .7500-20UNEF | .625 | 1.120 | .860 | 1.931 | .750 | .807 | .812 | 1.094 | 6-32NC | .120 | .672 |
| 14S | .8750-20UNEF | .450 | 1.307 | .672 | 1.588 | .562 | .932 | .906 | 1.188 | 6-32NC | .120 | .422 |
| 14 | .8750-20UNEF | .625 | 1.307 | .860 | 1.931 | .750 | .932 | .906 | 1.188 | 6-32NC | .120 | .672 |
| 16S | 1.0000-20UNEF | .450 | 1.432 | .672 | 1.588 | .562 | 1.057 | .969 | 1.281 | 6-32NC | .120 | .422 |
| 16 | 1.0000-20UNEF | .625 | 1.432 | .860 | 1.931 | .750 | 1.057 | .969 | 1.281 | 6-32NC | .120 | .672 |
| 18 | 1.1250-18NEF | .625 | 1.557 | .891 | 1.931 | .750 | 1.182 | 1.063 | 1.375 | 6-32NC | .120 | .641* |
| 20 | 1.2500-18NEF | .625 | 1.744 | .891 | 1.931 | .750 | 1.291 | 1.156 | 1.500 | 8-32NC | .120 | .641* |
| 22 | 1.3750-18NEF | .625 | 1.869 | .891 | 1.931 | .750 | 1.432 | 1.250 | 1.625 | 8-32NC | .120 | .641* |
| 24 | 1.5000-18NEF | .625 | 1.994 | .953 | 2.009 | .812 | 1.557 | 1.375 | 1.750 | 8-32NC | .147 | .578* |
| 28 | 1.7500-18NS | .625 | 2.166 | .953 | 2.009 | .812 | 1.807 | 1.562 | 2.000 | 8-32NC | .147 | .578* |
| 32 | 2.0000-18NS | .625 | 2.541 | 1.031 | 2.072 | .875 | 2.057 | 1.750 | 2.250 | 10-32NF | .173 | .500* |
| 36 | 2.2500-16UN | .625 | 2.729 | 1.031 | 2.072 | .875 | 2.260 | 1.938 | 2.500 | 10-32NF | .173 | .500* |
| 40 | 2.5000-16UN | .625 | 2.979 | 1.031 | 2.072 | .875 | 2.260 | 2.510 | 2.750 | 10-32NF | .173 | .500* |

* Increase Z dimension by .312 for size "0" contact only.

MS/Standard MS3101R cable connecting plug



To complete order number, see "how to order" pg. 70.
For solder well data, see page 67.
All lockwire holes are .045 dia. min.

| Shell Size | A Thread Class 2A | B Min. Full Thread | F Dia. Max. | J Dia. Max. | L Max. | Y Thread Class 2 | Z ±.040 |
|------------|-------------------|--------------------|-------------|-------------|--------|------------------|---------|
| 8S | .5000-28UNEF | .406 | .959 | .557 | 1.588 | 6-32NC | 1.094 |
| 10S | .6250-24NEF | .406 | 1.026 | .682 | 1.588 | 6-32NC | 1.094 |
| 10SL | .6250-24NEF | .406 | 1.120 | .807 | 1.588 | 6-32NC | 1.094 |
| 12S | .7500-20UNEF | .422 | 1.120 | .807 | 1.588 | 6-32NC | 1.094 |
| 12 | .7500-20UNEF | .656 | 1.120 | .807 | 1.931 | 6-32NC | 1.532 |
| 14S | .8750-20UNEF | .391 | 1.307 | .932 | 1.588 | 6-32NC | 1.094 |
| 14 | .8750-20UNEF | .625 | 1.307 | .932 | 1.931 | 6-32NC | 1.532 |
| 16S | 1.0000-20UNEF | .391 | 1.432 | 1.057 | 1.588 | 6-32NC | 1.094 |
| 16 | 1.0000-20UNEF | .625 | 1.432 | 1.057 | 1.931 | 6-32NC | 1.532 |
| 18 | 1.1250-18NEF | .625 | 1.557 | 1.182 | 1.931 | 6-32NC | 1.532* |
| 20 | 1.2500-18NEF | .625 | 1.744 | 1.291 | 1.931 | 8-32NC | 1.532* |
| 22 | 1.3750-18NEF | .625 | 1.869 | 1.432 | 1.931 | 8-32NC | 1.532* |
| 24 | 1.5000-18NEF | .625 | 1.994 | 1.557 | 2.009 | 8-32NC | 1.532* |
| 28 | 1.7500-18NS | .625 | 2.166 | 1.807 | 2.009 | 8-32NC | 1.532* |
| 32 | 2.0000-18NS | .625 | 2.541 | 2.057 | 2.072 | 10-32NF | 1.532* |
| 36 | 2.2500-16UN | .625 | 2.729 | 2.260 | 2.072 | 10-32NF | 1.532* |
| 40 | 2.5000-16UN | .625 | 2.979 | 2.510 | 2.072 | 10-32NF | 1.532* |

* Increase Z dimension by .312 for size "0" contact only.

MS/Standard MS3102R box mounting receptacle

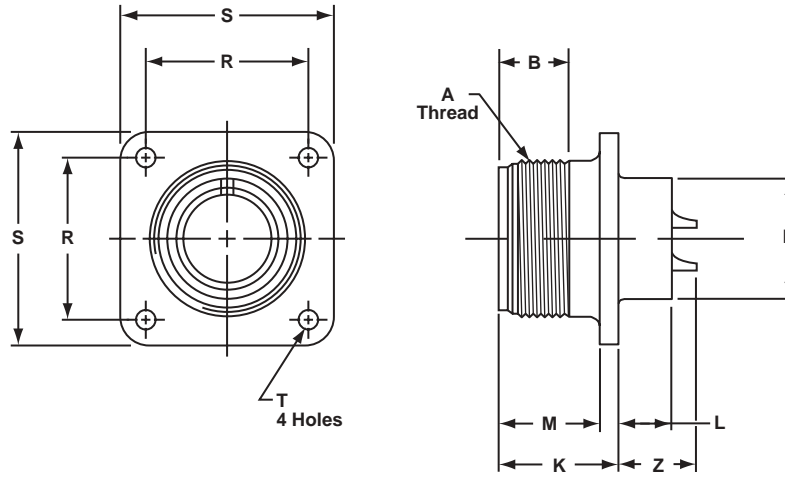

To complete order number, see "how to order" pg. 70.
For solder well data, see page 67.

| Shell Size | A Thread Class 2A | B Min. Full Thread | K $+0.020$ -0.010 | L $+0.000$ -0.010 | M $+0.010$ -0.000 | N Dia. $+0.010$ -0.000 | R ± 0.005 | S ± 0.031 | T Dia. $+0.004$ -0.002 | Z $+0.050$ -0.060 |
|------------|-------------------|--------------------|---------------------|---------------------|---------------------|--------------------------|---------------|---------------|--------------------------|---------------------|
| 8S | .5000-28UNEF | .391 | .672 | .297 | .562 | .375 | .594 | .875 | .120 | .422 |
| 10S | .6250-24NEF | .391 | .672 | .297 | .562 | .500 | .719 | 1.000 | .120 | .422 |
| 10SL | .6250-24NEF | .391 | .672 | .297 | .562 | .625 | .719 | 1.000 | .120 | .422 |
| 12S | .7500-20UNEF | .450 | .672 | .297 | .562 | .625 | .812 | 1.094 | .120 | .422 |
| 12 | .7500-20UNEF | .625 | .860 | .484 | .750 | .625 | .812 | 1.094 | .120 | .672 |
| 14S | .8750-20UNEF | .450 | .672 | .297 | .562 | .750 | .906 | 1.188 | .120 | .422 |
| 14 | .8750-20UNEF | .625 | .860 | .484 | .750 | .750 | .906 | 1.188 | .120 | .672 |
| 16S | 1.0000-20UNEF | .450 | .672 | .297 | .562 | .875 | .969 | 1.281 | .120 | .422 |
| 16 | 1.0000-20UNEF | .625 | .860 | .484 | .750 | .875 | .969 | 1.281 | .120 | .672 |
| 18 | 1.1250-18NEF | .625 | .891 | .453 | .750 | 1.000 | 1.062 | 1.375 | .120 | .641* |
| 20 | 1.2500-18NEF | .625 | .891 | .453 | .750 | 1.125 | 1.156 | 1.500 | .120 | .641* |
| 22 | 1.3750-18NEF | .625 | .891 | .453 | .750 | 1.250 | 1.250 | 1.625 | .120 | .641* |
| 24 | 1.5000-18NEF | .625 | .953 | .453 | .812 | 1.375 | 1.375 | 1.750 | .147 | .578* |
| 28 | 1.7500-18NS | .625 | .953 | .453 | .812 | 1.625 | 1.562 | 2.000 | .147 | .578* |
| 32 | 2.0000-18NS | .625 | 1.031 | .438 | .875 | 1.875 | 1.750 | 2.250 | .173 | .500* |
| 36 | 2.2500-16UN | .625 | 1.031 | .438 | .875 | 2.062 | 1.938 | 2.500 | .173 | .500* |
| 40 | 2.5000-16UN | .625 | 1.031 | .438 | .875 | 2.312 | 2.188 | 2.750 | .173 | .500* |

* Increase Z dimension by .312 for size "0" contact only.

MS/Standard MS3106R straight plug



To complete order number, see "how to order" pg. 70.
For solder well data, see page 67.
All lockwire holes are .045 dia. min.

| Shell Size | A Thread Class 2B | F Dia. Max. | J $\pm.005$ | L Max. | N Dia. Max. | Q Dia. Max. | Y Thread Class 2 | Z $\pm.045$ |
|------------|-------------------|-------------|-------------|--------|-------------|-------------|------------------|-------------|
| 8S | .5000-28UNEF | .959 | .531 | 1.057 | .557 | .741 | 6-32NC | .562 |
| 10S | .6250-24NEF | 1.026 | .531 | 1.057 | .682 | .869 | 6-32NC | .562 |
| 10SL | .6250-24NEF | 1.120 | .531 | 1.057 | .807 | .946 | 6-32NC | .562 |
| 12S | .7500-20UNEF | 1.120 | .531 | 1.057 | .807 | .995 | 6-32NC | .562 |
| 12 | .7500-20UNEF | 1.120 | .719 | 1.212 | .807 | .995 | 6-32NC | .812 |
| 14S | .8750-20UNEF | 1.307 | .531 | 1.057 | .932 | 1.123 | 6-32NC | .562 |
| 14 | .8750-20UNEF | 1.307 | .719 | 1.212 | .932 | 1.123 | 6-32NC | .812 |
| 16S | 1.0000-20UNEF | 1.432 | .531 | 1.057 | 1.057 | 1.250 | 6-32NC | .562 |
| 16 | 1.0000-20UNEF | 1.432 | .719 | 1.212 | 1.057 | 1.250 | 6-32NC | .812 |
| 18 | 1.1250-18NEF | 1.557 | .719 | 1.212 | 1.182 | 1.333 | 6-32NC | .812* |
| 20 | 1.2500-18NEF | 1.744 | .719 | 1.212 | 1.291 | 1.461 | 8-32NC | .812* |
| 22 | 1.3750-18NEF | 1.869 | .719 | 1.212 | 1.432 | 1.588 | 8-32NC | .812* |
| 24 | 1.5000-18NEF | 1.994 | .719 | 1.291 | 1.557 | 1.715 | 8-32NC | .812* |
| 28 | 1.7500-18NS | 2.166 | .719 | 1.291 | 1.807 | 1.968 | 8-32NC | .812* |
| 32 | 2.0000-18NS | 2.541 | .719 | 1.353 | 2.057 | 2.209 | 10-32NF | .812* |
| 36 | 2.2500-16UN | 2.729 | .719 | 1.353 | 2.260 | 2.463 | 10-32NF | .812* |
| 40 | 2.5000-16UN | 2.979 | .719 | 1.353 | 2.510 | 2.719 | 10-32NF | .812* |

* Increase Z dimension by .312 for size "0" contact only.

MS/Standard
contact and
insert arrangements

MS/Standard insert arrangements

| Insert Arrangement | Service Rating | Total Contacts | Contact Size | | | | |
|--------------------|----------------|----------------|--------------|---|---|----|----|
| | | | 0 | 4 | 8 | 12 | 16 |
| 8S-1 | A | 1 | | | | | 1 |
| 10S-2 | A | 1 | | | | | 1 |
| 10SL-3 | A | 3 | | | | | 3 |
| 10SL-4† | A | 2 | | | | | 2 |
| 12S-3 | A | 2 | | | | | 2 |
| 12S-4 | D | 1 | | | | | 1 |
| 12-5 | D | 1 | | | | 1 | |
| 14S-1 | A | 3 | | | | | 3 |
| 14S-2 | Inst. | 4 | | | | | 4 |
| 14S-4 | D | 1 | | | | | 1 |
| 14S-5 | Inst. | 5 | | | | | 5 |
| 14S-6 | Inst. | 6 | | | | | 6 |
| 14S-7 | A | 3 | | | | | 3 |
| 14S-9 | A | 2 | | | | | 2 |
| 14S-10 | Inst. | 4 | | | | | 4 |
| 14S-12 | A | 3 | | | | | 3 |
| 14-3 | A | 1 | | | 1 | | |
| 16S-1 | A | 7 | | | | | 7 |
| 16S-3 | B | 1 | | | | | 1 |
| 16S-4 | D | 2 | | | | | 2 |
| 16S-5 | A | 3 | | | | | 3 |
| 16S-6 | A | 3 | | | | | 3 |
| 16S-8 | A | 5 | | | | | 5 |
| 16-2 | E | 1 | | | | 1 | |
| 16-7 | A | 3 | | | 1 | | 2 |
| 16-9 | A | 4 | | | | 2 | 2 |
| 16-10 | A | 3 | | | | 3 | |
| 16-11 | A | 2 | | | | 2 | |
| 16-12 | A | 1 | | 1 | | | |
| 16-13 | A | 2 | | | | 2 | |
| 18-1 | A/Inst. | 10 | | | | | 10 |
| 18-3 | D | 2 | | | | 2 | |
| 18-4 | D | 4 | | | | | 4 |
| 18-5 | D | 3 | | | | 2 | 1 |
| 18-6 | D | 1 | | 1 | | | |
| 18-7 | B | 1 | | | 1 | | |
| 18-8 | A | 8 | | | | 1 | 7 |
| 18-9 | Inst. | 7 | | | | 2 | 5 |
| 18-10 | A | 4 | | | | 4 | |
| 18-11 | A | 5 | | | | 5 | |
| 18-12 | A | 6 | | | | | 6 |
| 18-13 | A | 4 | | | 1 | 3 | |
| 18-14 | A | 2 | | 1 | | | 1 |
| 18-15 | A | 4 | | | | 4 | |
| 18-16 | C | 1 | | | | 1 | |
| 18-17 | Inst. | 7 | | | | 2 | 5 |
| 18-19 | A | 10 | | | | | 10 |
| 18-20 | A | 5 | | | | | 5 |
| 18-22 | D | 3 | | | | | 3 |
| 18-24 | A/Inst. | 10 | | | | | 10 |
| 18-29 | A | 5 | | | | | 5 |
| 18-30 | A | 5 | | | | | 5 |

| Insert Arrangement | Service Rating | Total Contacts | Contact Size | | | | |
|--------------------|----------------|----------------|--------------|---|---|----|----|
| | | | 0 | 4 | 8 | 12 | 16 |
| 18-31 | A | 5 | | | | | 5 |
| 20-2 | D | 1 | 1 | | | | |
| 20-3 | D | 3 | | | | 3 | |
| 20-4 | D | 4 | | | | 4 | |
| 20-6 | D | 3 | | | | | 3 |
| 20-7 | D/A | 8 | | | | | 8 |
| 20-8 | Inst. | 6 | | | 2 | | 4 |
| 20-9 | D/A | 8 | | | | 1 | 7 |
| 20-11 | Inst. | 13 | | | | | 13 |
| 20-12 | A | 2 | | 1 | | | 1 |
| 20-14 | A | 5 | | | 2 | 3 | |
| 20-15 | A | 7 | | | | 7 | |
| 20-16 | A | 9 | | | | 2 | 7 |
| 20-17 | A | 6 | | | | 5 | 1 |
| 20-18 | A | 9 | | | | 3 | 6 |
| 20-19 | A | 3 | | | 3 | | |
| 20-20 | A | 4 | | 1 | | 3 | |
| 20-21 | A | 9 | | | | 1 | 8 |
| 20-22 | A | 6 | | | 3 | | 3 |
| 20-23 | A | 2 | | | 2 | | |
| 20-24 | A | 4 | | | 2 | | 2 |
| 20-25 | Inst. | 13 | | | | | 13 |
| 20-27 | A | 14 | | | | | 14 |
| 20-29 | A | 17 | | | | | 17 |
| 20-30 | Inst. | 13 | | | | | 13 |
| 20-33 | A | 11 | | | | | 11 |
| 22-1 | D | 2 | | | 2 | | |
| 22-2 | D | 3 | | | 3 | | |
| 22-4 | A | 4 | | | 2 | 2 | |
| 22-5 | D | 6 | | | | 2 | 4 |
| 22-6 | D | 3 | | | 2 | | 1 |
| 22-7 | E | 1 | 1 | | | | |
| 22-8 | E | 2 | | | | 2 | |
| 22-9 | E | 3 | | | | 3 | |
| 22-10 | E | 4 | | | | | 4 |
| 22-11 | B | 2 | | | | | 2 |
| 22-12 | D | 5 | | | 2 | | 3 |
| 22-13 | D/A | 5 | | | | 4 | 1 |
| 22-14 | A | 19 | | | | | 19 |
| 22-15 | E/A | 6 | | | | 5 | 1 |
| 22-16 | A | 9 | | | | 3 | 6 |
| 22-17 | D/A | 9 | | | | 1 | 8 |
| 22-18 | D/A | 8 | | | | | 8 |
| 22-19 | A | 14 | | | | | 14 |
| 22-20 | A | 9 | | | | | 9 |
| 22-21 | A | 3 | 1 | | | | 2 |
| 22-22 | A | 4 | | | 4 | | |
| 22-23 | D/A | 8 | | | | 8 | |
| 22-24 | D/A | 6 | | | | 2 | 4 |
| 22-27 | D/A | 9 | | | 1 | | 8 |
| 22-28 | A | 7 | | | | 7 | |

† 10SL-4 arrangement available only with pin contacts in receptacle and socket contacts in plug

MS/Standard insert arrangements, cont.

| Insert Arrangement | Service Rating | Total Contacts | Contact Size | | | | |
|--------------------|----------------|----------------|--------------|---|---|----|----|
| | | | 0 | 4 | 8 | 12 | 16 |
| 22-33 | D/A | 7 | | | | | 7 |
| 22-34 | D | 5 | | | | 3 | 2 |
| 22-36 | D/A | 8 | | | | 8 | |
| 24-2 | D | 7 | | | | 7 | |
| 24-3 | D | 7 | | | | 2 | 5 |
| 24-5 | A | 16 | | | | | 16 |
| 24-6 | D/A | 8 | | | | 8 | |
| 24-7 | A | 16 | | | | 2 | 14 |
| 24-9 | A | 2 | | 2 | | | |
| 24-10 | A | 7 | | | 7 | | |
| 24-11 | A | 9 | | | 3 | 6 | |
| 24-12 | A | 5 | | 2 | | 3 | |
| 24-16 | D/A | 7 | | | 1 | 3 | 3 |
| 24-17 | D | 5 | | | | 2 | 3 |
| 24-20 | D | 11 | | | | 2 | 9 |
| 24-21 | D | 10 | | | 1 | | 9 |
| 24-22 | D | 4 | | | 4 | | |
| 24-27 | E | 7 | | | | | 7 |
| 24-28 | Inst. | 24 | | | | | 24 |
| 28-1 | D/A | 9 | | | 3 | 6 | |
| 28-2 | D | 14 | | | | 2 | 12 |
| 28-3 | E | 3 | | | 3 | | |
| 28-4 | E/D | 9 | | | | 2 | 7 |
| 28-5 | D | 5 | | 2 | | 1 | 2 |
| 28-6 | D | 3 | | 3 | | | |
| 28-7 | D | 2 | | 2 | | | |
| 28-8 | E/D/A | 12 | | | | 2 | 10 |
| 28-9 | D | 12 | | | | 6 | 6 |
| 28-10 | D/A | 7 | | 2 | 2 | 3 | |
| 28-11 | A | 22 | | | | 4 | 18 |
| 28-12 | A | 26 | | | | | 26 |
| 28-13 | A | 26 | | | | | 26 |
| 28-15 | A | 35 | | | | | 35 |
| 28-16 | A | 20 | | | | | 20 |
| 28-17 | B/D/A | 15 | | | | | 15 |
| 28-18 | C/D/A/Inst. | 12 | | | | | 12 |
| 28-19 | B/D/A | 10 | | | | 4 | 6 |
| 28-20 | A | 14 | | | | 10 | 4 |
| 28-21 | A | 37 | | | | | 37 |
| 28-22 | D | 6 | | 3 | | | 3 |

| Insert Arrangement | Service Rating | Total Contacts | Contact Size | | | | |
|--------------------|----------------|----------------|--------------|---|---|----|----|
| | | | 0 | 4 | 8 | 12 | 16 |
| 32-1 | E/D | 5 | 2 | | | 3 | |
| 32-2 | E | 5 | | 3 | | | 2 |
| 32-3 | D | 9 | 1 | 2 | | 2 | 4 |
| 32-4 | A/D | 14 | | | | 2 | 12 |
| 32-5 | D | 2 | 2 | | | | |
| 32-6 | A | 23 | | 2 | 3 | 2 | 16 |
| 32-7 | Inst./A | 35 | | | | 7 | 28 |
| 32-8 | A | 30 | | | | 6 | 24 |
| 32-9 | D | 14 | | 2 | | | 12 |
| 32-10 | E/B/D/A | 7 | | 2 | 2 | | 3 |
| 32-12 | A/D | 15 | | | | 5 | 10 |
| 32-13 | D | 23 | | | | 5 | 18 |
| 32-15 | D | 8 | 2 | | | 6 | |
| 32-16 | A | 23 | | 2 | 3 | 2 | 16 |
| 32-17 | D | 4 | | 4 | | | |
| 32-22 | A | 54 | | | | | 54 |
| 36-1 | D | 22 | | | | 4 | 18 |
| 36-3 | D | 6 | 3 | | | 3 | |
| 36-4 | D/A | 3 | 3 | | | | |
| 36-5 | A | 4 | 4 | | | | |
| 36-6 | A | 6 | 2 | 4 | | | |
| 36-7 | A | 47 | | | | 7 | 40 |
| 36-8 | A | 47 | | | | 1 | 46 |
| 36-9 | A | 31 | | 1 | 2 | 14 | 14 |
| 36-10 | A | 48 | | | | | 48 |
| 36-11 | A | 48 | | | | | 48 |
| 36-12 | A | 48 | | | | | 48 |
| 36-13 | E/A | 17 | | | | 2 | 15 |
| 36-14 | D | 16 | | | 5 | 5 | 6 |
| 36-15 | D/A | 35 | | | | | 35 |
| 36-16 | A | 47 | | | | 7 | 40 |
| 36-17 | A | 47 | | | | 7 | 40 |
| 36-18 | A | 31 | | 1 | 2 | 14 | 14 |
| 36-20 | A | 34 | | | 2 | 2 | 30 |
| 36-52 | A | 52 | | | | | 52 |
| 40-1 | D | 30 | | | | 6 | 24 |
| 40-9 | A | 47 | | | 1 | 22 | 24 |
| 40-56 | A | 85 | | | | | 85 |
| 48-62 | D | 85 | | | | | 85 |

MS/Standard special insert arrangements

| Insert Arrange ment | Service Rating | Total Con- tacts | Contact Size | | | | | | | | | | | | | | | | | |
|---------------------------|-------------------|------------------------|--------------|-----|---|---|---|----|----|--------|----|---|----|--|--|--|--|--|--|----|
| | | | 4/0 | 2/0 | 0 | 4 | 8 | 12 | 16 | Coax** | | | | | | | | | | |
| | | | | | | | | | | 0 | 4 | 8 | 12 | | | | | | | |
| 14S-A7 | A | 7 | | | | | | | | 7 | | | | | | | | | | |
| 16-59 | A | 4 | | | | | | | | 4 | | | | | | | | | | |
| 20-26 | A | 19 | | | | | | | | | | | 19 | | | | | | | |
| 20-51 | A | 3 | | | | | | 3 | | | | | | | | | | | | |
| 20-57 | A | 7 | | | | | | | | 7* | | | | | | | | | | |
| 20-58 | A | 10 | | | | | | | | 5 | 5 | | | | | | | | | |
| 20-59 | A | 3 | | | | | | 3* | | | | | | | | | | | | |
| 20-66 | A | 6 | | | | | | | | 5* | 1 | | | | | | | | | |
| 20-79 | A/D | 8 | | | | | | | | 1 | 7 | | | | | | | | | |
| 22-63 | A | 12 | | | | | | | | 4 | 8 | | | | | | | | | |
| 22-65 | A/D | 8 | | | | | | | | 8* | | | | | | | | | | |
| 22-70 | A | 13 | | | | | | | | 8 | 5 | | | | | | | | | |
| 22-80 | A | 3 | | | | | | 3* | | | | | | | | | | | | |
| 24-19 | A | 12 | | | | | | | | | | | 12 | | | | | | | |
| 24-51 | A | 5 | | | | | | 5 | | | | | | | | | | | | |
| 24-52 | Hi Volt. | 1 | | | | | | | | 1 | | | | | | | | | | |
| 24-53 | A | 5 | | | | | | 5 | | | | | | | | | | | | |
| 24-58 | A | 13 | | | | | | 3 | 3 | 7 | | | | | | | | | | |
| 24-59 | A | 14 | | | | | | | | 7 | 7 | | | | | | | | | |
| 24-60 | A | 7 | | | | | | 7* | | | | | | | | | | | | |
| 24-65 | A | 15 | | | | | | | | 11 | 4 | | | | | | | | | |
| 24-66 | D | 7 | | | | | | | | 7 | | | | | | | | | | |
| 24-67 | Inst. | 19 | | | | | | | | | 19 | | | | | | | | | |
| 24-71 | A | 7 | | | | | | 7* | | | | | | | | | | | | |
| 24-75 | A | 7 | | | | | | 7* | | | | | | | | | | | | |
| 24-79 | A | 5 | | | | | | 5 | | | | | | | | | | | | |
| 24-80 | Inst. | 23 | | | | | | | | | 23 | | | | | | | | | |
| 24-84 | A | 19 | | | | | | | | 1 | | | | | | | | | | 18 |
| 24-96 | Inst. | 28 | | | | | | | | | 28 | | | | | | | | | |
| 24-AJ | A | 25 | | | | | | | | | 25 | | | | | | | | | |
| 28-51 | A | 12 | | | | | | | | 12 | | | | | | | | | | |
| 28-59 | A | 17 | | | | | | | | 7 | 10 | | | | | | | | | |
| 28-66 | A | 16 | | | | | | 2 | 14 | | | | | | | | | | | |
| 28-72 | Coax | 3 | | | | | | | | | | | | | | | | | | 3 |
| 28-74 | A | 16 | | | | | | 7* | | 9 | | | | | | | | | | |
| 28-75 | A | 16 | | | | | | 7* | | 9 | | | | | | | | | | |
| 28-79 | A | 16 | | | | | | 7 | | 9 | | | | | | | | | | |
| 28-82 | D | 6 | | | | | | 2 | 4 | | | | | | | | | | | |
| 28-84 | A | 9 | | | | | | 9 | | | | | | | | | | | | |
| 28-AY | A | 9 | | | | 4 | | | | 5 | | | | | | | | | | |
| 32-14 | D | 13 | | | | | | | | 13 | | | | | | | | | | |
| 32-25 | A | 25 | | | | | | | | 25 | | | | | | | | | | |
| 32-31 | A | 31 | | | | | | | | | 31 | | | | | | | | | |
| 32-48 | Inst. | 48 | | | | | | | | | 48 | | | | | | | | | |
| 32-52 | D | 8 | | | 2 | | | | | 6 | | | | | | | | | | |
| 32-53 | Inst./E | 42 | | | | | | | | 5 | 37 | | | | | | | | | |
| 32-56 | A | 30 | | | | | | | | 6* | 24 | | | | | | | | | |
| 32-57 | Coax | 8 | | | | | | | | 6 | | 2 | | | | | | | | |
| 32-58 | Coax | 4 | | | | | | | | | | | 4 | | | | | | | |
| 32-59 | A | 42 | | | | | | | | | 40 | | | | | | | | | 2 |
| 32-60 | A | 23 | | | | | | | | | 15 | | | | | | | | | 8 |
| 32-62 | Coax | 23 | | | | 2 | 1 | 2 | 16 | | | | | | | | | | | 2 |
| 32-64 | Inst. | 54 | | | | | | | | | 54 | | | | | | | | | |
| 32-68 | A | 16 | | | | | | | | | 12 | | 4 | | | | | | | |
| 32-73 | A | 46 | | | | | | | | | 46 | | | | | | | | | |
| 32-75 | Coax | 9 | | | | | | | | 2 | | | | | | | | | | 7 |
| 32-76 | A | 19 | | | | | | | | 19 | | | | | | | | | | |
| 32-79 | D | 5 | | | | 4 | 1 | | | | | | | | | | | | | |
| 32-82 | A | 16 | | | | 4 | | | | | 12 | | | | | | | | | |

| Insert Arrange ment | Service Rating | Total Con- tacts | Contact Size | | | | | | | | | | | | | | | | | | |
|---------------------------|-------------------|------------------------|--------------|-----|---|---|---|----|----|--------|----|---|-----|-----|----|---|----|---|---|----|--|
| | | | 4/0 | 2/0 | 0 | 4 | 8 | 12 | 16 | Coax** | | | | | | | | | | | |
| | | | | | | | | | | 0 | 4 | 8 | 12 | | | | | | | | |
| 32-AF | A | 55 | | | | | | | | | | | 55 | | | | | | | | |
| 36-22 | D | 22 | | | | | | | | | | | 22 | | | | | | | | |
| 36-51 | D | 4 | | | | 2 | 2 | | | | | | | | | | | | | | |
| 36-54 | A | 39 | | | | | | | | 8 | | | | 31 | | | | | | | |
| 36-55 | A | 39 | | | | | | | | 8* | | | | 31 | | | | | | | |
| 36-59 | A | 53 | | | | | | | | | | | 3* | 50 | | | | | | | |
| 36-60 | A | 47 | | | | | | | | | | | 7* | 40 | | | | | | | |
| 36-64 | Coax | 4 | | | | | | | | | | | | | | | 4 | | | | |
| 36-65 | Coax | 4 | | | | | | | | | | | | | | | 4 | | | | |
| 36-71 | A | 53 | | | | | | | | | | | 3 | 50 | | | | | | | |
| 36-73 | Coax | 7 | | | | | | | | | | | | | | | | 7 | | | |
| 36-74 | A | 44 | | | | | | | | | | | | 43 | | | | | | 1 | |
| 36-75 | A | 48 | | | | | | | | | | | | 48* | | | | | | | |
| 36-76 | A | 47 | | | | | | | | | | | | 47 | | | | | | | |
| 36-77 | D | 7 | | | | | | 7 | | | | | | | | | | | | | |
| 36-78 | A | 14 | | | | | | | | 12 | | | | 2 | | | | | | | |
| 36-79 | A | 20 | | | | | | | | | | | 20 | | | | | | | | |
| 36-80 | A | 20 | | | | | | | | | | | 20* | | | | | | | | |
| 36-83 | Coax | 7 | | | | | | | | | | | | | | | | | 7 | | |
| 36-85 | A/D | 35 | | | | | | | | | | | | 35* | | | | | | | |
| 36-97 | C | 1 | 1 | | | | | | | | | | | | | | | | | | |
| 36-99 | D | 12 | | | | | | 3 | 3 | 3 | 3 | | | | | | | | | | |
| 36-AF | A | 48 | | | | | | | | | | | | 48 | | | | | | | |
| 40-5 | A | 5 | | | | | | 5 | | | | | | | | | | | | | |
| 40-10 | A | 29 | | | | | | | 4 | 9 | | | | 16 | | | | | | | |
| 40-30 | A | 30 | | | | | | | 1 | | | | 29 | | | | | | | | |
| 40-35 | D | 35 | | | | | | | | | | | 35 | | | | | | | | |
| 40-53 | A | 60 | | | | | | | | | | | | 60 | | | | | | | |
| 40-57 | E | 4 | | | | 4 | | | | | | | | | | | | | | | |
| 40-61 | A | 59 | | | | | | | | | 1 | 3 | | 55 | | | | | | | |
| 40-62 | A | 60 | | | | | | | | | | | | 60 | | | | | | | |
| 40-63 | A | 61 | | | | | | | | | | | | 61* | | | | | | | |
| 40-64 | Coax | 36 | | | | | | | | | | 3 | 20 | | | | | | | 13 | |
| 40-66 | Coax | 4 | | | | | | | | | | | | | | | 4 | | | | |
| 40-67 | A | 11 | | | | | | | | | | | | 1 | | | 10 | | | | |
| 40-68 | A | 21 | | | | | | | | 21 | | | | | | | | | | | |
| 40-70 | A | 61 | | | | | | | | | | | | 61 | | | | | | | |
| 40-72 | A | 11 | | | | | | | | | | | | 1 | | | 10 | | | | |
| 40-73 | A | 61 | | | | | | | | | | | | 61 | | | | | | | |
| 40-74 | A | 6 | | | | | | | | | | | 1 | | | 4 | 1 | | | | |
| 40-75 | E | 5 | | | | 4 | | | | | | | 1 | | | | | | | | |
| 40-80 | A | 11 | | | | | | | | 10 | | | | 1 | | | | | | | |
| 40-81 | A | 62 | | | | | | | | | | | | 62* | | | | | | | |
| 40-82 | A | 62 | | | | | | | | | | | | 62 | | | | | | | |
| 40-85 | A | 60 | | | | | | | | | | | | 60* | | | | | | | |
| 40-86 | E | 4 | | | | | | | | | | | | | | 4 | | | | | |
| 40-87 | D | 7 | | | | | | | | 7 | | | | | | | | | | | |
| 40-AD | A | 8 | | | | 4 | | | | 4 | | | | | | | | | | | |
| 40-AG | A | 38 | | | | | | | | | | | | 38 | | | | | | | |
| 40-AP | E | 2 | 2 | | | | | | | | | | | | | | | | | | |
| 40-AR | Inst. | 13 | | | | | | 3 | 3 | | | | 7 | | | | | | | | |
| 40-AS | A | 40 | | | | | | | | | | | | 25 | 15 | | | | | | |
| 40-AT | A | 43 | | | | | | | | | | 1 | 24 | 18 | | | | | | | |
| 40-AU | A | 14 | | | | | | | | 3 | 10 | | | 1 | | | | | | | |
| 40-AV | D | 3 | | | | 3 | | | | | | | | | | | | | | | |

MS/Standard insert alternate positioning

To avoid cross-plugging problems in applications requiring the use of more than one connector of the same size and arrangement, alternate rotations are available as indicated in the accompanying charts.

As shown in the diagram below, the front face of the pin insert is rotated within the shell in a clockwise direction from the normal shell key. The socket insert would be rotated counter-clockwise the same number of degrees in respect to the normal shell key.



The following insert arrangements have the same alternate insert rotations for W, X, Y and Z, which are:

| Degrees | | | |
|---------|-----|-----|-----|
| W | X | Y | Z |
| 80 | 110 | 250 | 280 |

| | | | | | |
|-------|-------|-------|-------|-------|-------|
| 16-7 | 20-22 | 22-29 | 24-17 | 28-16 | 32-13 |
| 18-5 | 22-6 | 22-33 | 24-20 | 28-17 | 32-22 |
| 18-9 | 22-12 | 22-34 | 24-21 | 28-19 | 32-AF |
| 18-13 | 22-14 | 24-1 | 24-28 | 28-20 | 36-1 |
| 18-14 | 22-15 | 24-3 | 28-1 | 28-21 | 36-7 |
| 20-7 | 22-16 | 24-4 | 28-4 | 32-1 | 36-8 |
| 20-8 | 22-17 | 24-5 | 28-8 | 32-3 | 36-13 |
| 20-9 | 22-18 | 24-6 | 28-9 | 32-4 | 40-AR |
| 20-12 | 22-19 | 24-7 | 28-10 | 32-6 | 40-AS |
| 20-14 | 22-21 | 24-12 | 28-11 | 32-9 | 40-AT |
| 20-16 | 22-24 | 24-14 | 28-14 | 32-10 | 40-AU |
| 20-20 | 22-25 | 24-16 | 28-15 | 32-12 | |







| Insert Arrangement | Degrees | | | |
|--------------------|---------|-----|-----|-----|
| | W | X | Y | Z |
| 10SL-4 | 63 | - | - | - |
| 12S-3 | 70 | 145 | 215 | 290 |
| 14S-2 | - | 120 | 240 | - |
| 14S-5 | - | 110 | - | - |
| 14S-7 | 90 | 180 | 270 | - |
| 14S-9 | 70 | 145 | 215 | 290 |
| 16-9 | 35 | 110 | 250 | 325 |
| 16-10 | 90 | 180 | 270 | - |
| 16-11 | 35 | 110 | 250 | 325 |
| 16-13 | 35 | 110 | 250 | 325 |
| 16S-1 | 80 | - | - | 280 |
| 16S-4 | 35 | 110 | 250 | 325 |
| 16S-5 | 70 | 145 | 215 | 290 |
| 16S-6 | 90 | 180 | 270 | - |
| 16S-8 | - | 170 | 265 | - |
| 18-1 | 70 | 145 | 215 | 290 |
| 18-3 | 35 | 110 | 250 | 325 |
| 18-4 | 35 | 110 | 250 | 325 |
| 18-8 | 70 | - | - | 290 |
| 18-10 | - | 120 | 240 | - |
| 18-11 | - | 170 | 265 | - |
| 18-12 | 80 | - | - | 280 |
| 18-15 | - | 120 | 240 | - |
| 18-20 | 90 | 180 | 270 | - |
| 18-22 | 70 | 145 | 215 | 290 |
| 18-29 | 90 | 180 | 270 | - |
| 20-3 | 70 | 145 | 215 | 290 |
| 20-4 | 45 | 110 | 250 | - |
| 20-5 | 35 | 110 | 250 | 325 |
| 20-6 | 70 | 145 | 215 | 290 |
| 20-15 | 80 | - | - | 280 |
| 20-17 | 90 | 180 | 270 | - |
| 20-18 | 35 | 110 | 250 | 325 |
| 20-19 | 90 | 180 | 270 | - |
| 20-21 | 35 | 110 | 250 | 325 |







| Insert Arrangement | Degrees | | | |
|--------------------|---------|-----|-----|-----|
| | W | X | Y | Z |
| 20-23 | 35 | 110 | 250 | 325 |
| 20-24 | 35 | 110 | 250 | 325 |
| 20-27 | 35 | 110 | 250 | 325 |
| 20-29 | 80 | - | - | 280 |
| 22-1 | 35 | 110 | 250 | 325 |
| 22-2 | 70 | 145 | 215 | 290 |
| 22-4 | 35 | 110 | 250 | 325 |
| 22-5 | 35 | 110 | 250 | 325 |
| 22-8 | 35 | 110 | 250 | 325 |
| 22-9 | 70 | 145 | 215 | 290 |
| 22-10 | 35 | 110 | 250 | 325 |
| 22-11 | 35 | 110 | 250 | 325 |
| 22-13 | 35 | 110 | 250 | 325 |
| 22-20 | 35 | 110 | 250 | 325 |
| 22-22 | - | 110 | 250 | - |
| 22-23 | 35 | - | 250 | - |
| 22-27 | 80 | - | 250 | 280 |
| 22-28 | 80 | - | - | 280 |
| 22-63 | 20 | - | - | - |
| 24-2 | 80 | - | - | 280 |
| 24-9 | 35 | 110 | 250 | 325 |
| 24-10 | 80 | - | - | 280 |
| 24-11 | 35 | 110 | 250 | 325 |
| 24-22 | 45 | 110 | 250 | - |
| 24-27 | 80 | - | - | 280 |
| 28-2 | 35 | 110 | 250 | 325 |
| 28-3 | 70 | 145 | 215 | 290 |
| 28-5 | 35 | 110 | 250 | 325 |
| 28-6 | 70 | 145 | 215 | 290 |
| 28-7 | 35 | 110 | 250 | 325 |
| 28-12 | 90 | 180 | 270 | - |
| 28-18 | 70 | 145 | 215 | 290 |
| 28-22 | 70 | 145 | 215 | 290 |
| 28-AY | 45 | 110 | 250 | - |
| 32-2 | 70 | 145 | 215 | 290 |







| Insert Arrangement | Degrees | | | |
|--------------------|---------|-----|-----|-----|
| | W | X | Y | Z |
| 32-5 | 35 | 110 | 250 | 325 |
| 32-7 | 80 | 125 | 235 | 280 |
| 32-8 | 80 | 125 | 235 | 280 |
| 32-14 | 65 | 130 | 230 | 295 |
| 32-15 | 35 | 110 | 250 | 280 |
| 32-17 | 45 | 110 | 250 | - |
| 32-25 | 60 | 120 | - | - |
| 32-48 | 80 | - | - | - |
| 32-64 | 80 | 100 | 110 | 250 |
| 32-68 | 30 | - | - | - |
| 32-82 | 30 | - | - | - |
| 36-3 | 70 | 145 | 215 | 290 |
| 36-4 | 70 | 145 | 215 | 290 |
| 36-5 | - | 120 | 240 | - |
| 36-6 | 35 | 110 | 250 | 325 |
| 36-9 | 80 | 125 | 235 | 280 |
| 36-10 | 80 | 125 | 235 | 280 |
| 36-14 | 90 | 180 | 270 | - |
| 36-15 | 60 | 125 | 245 | 305 |
| 36-AF | 65 | - | - | - |
| 40-1 | 65 | 130 | 235 | 300 |
| 40-5 | 33 | - | - | 270 |
| 40-9 | 65 | 125 | 225 | 310 |
| 40-10 | 65 | 125 | 225 | 310 |
| 40-35 | 70 | 130 | 230 | 290 |
| 40-AD | 45 | - | - | - |
| 40-AG | 37 | 74 | 285 | 322 |
| 40-AP | 35 | 110 | 250 | 325 |
| 40-AV | 90 | 180 | 270 | - |







MS/Standard contact arrangements

front face of pin insert or rear face of socket insert illustrated

| | | | | | | | |
|---------------------------|---|---|---|---|---|---|---|
| |  |  |  |  |  |  |  |
| | | | Front of Socket Insert | Front of Socket Insert | | | |
| Insert Arrangement | 8S-1 | 10S-2 | 10SL-3 | 10SL-4 | 12S-3 | 12S-4 | 12-5 |
| Service Rating | A | A | A | A | A | D | D |
| Number of Contacts | 1 | 1 | 3 | 2 | 2 | 1 | 1 |
| Contact Size | 16 | 16 | 16 | 16 | 16 | 16 | 12 |

| | | | | | | | |
|---------------------------|---|---|---|---|---|---|---|
| |  |  |  |  |  |  |  |
| Insert Arrangement | 14S-1 | 14S-2 | 14S-4 | 14S-5 | 14S-6 | 14S-7 | 14S-9 |
| Service Rating | A | Inst. | D | Inst. | Inst. | A | A |
| Number of Contacts | 3 | 4 | 1 | 5 | 6 | 3 | 2 |
| Contact Size | 16 | 16 | 16 | 16 | 16 | 16 | 16 |

| | | | | | | |
|---------------------------|---|---|---|--|---|---|
| |  |  |  |  |  |  |
| | 100° Rotation of 14S-2 | 100° Rotation of 14S-7 | | | | |
| Insert Arrangement | 14S-10 | 14S-12 | 14-3 | 16S-1 | 16S-3 | 16S-4 |
| Service Rating | Inst. | A | A | A | B | D |
| Number of Contacts | 4 | 3 | 1 | 7 | 1 | 2 |
| Contact Size | 16 | 16 | 8 | 16 | 16 | 16 |

| | | | | | | |
|---------------------------|---|---|---|--|---|---|
| |  |  |  |  |  |  |
| Insert Arrangement | 16S-5 | 16S-6 | 16S-8 | 16-2 | 16-7 | 16-9 |
| Service Rating | A | A | A | E | A | A |
| Number of Contacts | 3 | 3 | 5 | 1 | 1 2 | 2 2 |
| Contact Size | 16 | 16 | 16 | 12 | 8 16 | 12 16 |

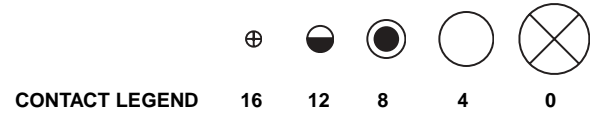

MS/Standard contact arrangements

front face of pin insert or rear face of socket insert illustrated

| | | | | | | |
|---------------------------|--------------|--------------|--------------|--------------|-------------------------------------|-------------------------------------|
| | | | | | | |
| Insert Arrangement | 16-10 | 16-11 | 16-12 | 16-13 | 18-1 | 18-3 |
| Service Rating | A | A | A | A | B, C, F, G = A; Bal. = Inst. | D |
| Number of Contacts | 3 | 2 | 1 | 2* | 10 | 2 |
| Contact Size | 12 | 12 | 4 | 12 | 16 | 12 |
| | | | | | | |
| Insert Arrangement | 18-4 | 18-5 | 18-6 | 18-7 | 18-8 | 18-9 |
| Service Rating | D | D | D | B | A | Inst. |
| Number of Contacts | 4 | 2 1 | 1 | 1 | 1 7 | 2 5 |
| Contact Size | 16 | 12 16 | 4 | 8 | 12 16 | 12 16 |
| | | | | | | |
| Insert Arrangement | 18-10 | 18-11 | 18-12 | 18-13 | 18-14 | 18-15 |
| Service Rating | A | A | A | A | A | A |
| Number of Contacts | 4 | 5 | 6 | 1 3 | 1 1 | 4** |
| Contact Size | 12 | 12 | 16 | 8 12 | 4 16 | 12 |
| | | | | | | |
| Insert Arrangement | 18-16 | 18-17 | 18-19 | 18-20 | 18-22 | 18-24 |
| Service Rating | C | Inst. | A | A | D | B, C, F, G = A; Bal. = Inst. |
| Number of Contacts | 1 | 2 5 | 10 | 5 | 3 | 10 |
| Contact Size | 12 | 12 16 | 16 | 16 | 16 | 16 |

* A = Iron; B = Constantan
** A, C = Iron; B, D = Constantan



MS/Standard contact arrangements

front face of pin insert or rear face of socket insert illustrated



| | | | | | | |
|---------------------------|--------------|--------------|--------------|-------------|-------------|-------------|
| Insert Arrangement | 18-29 | 18-30 | 18-31 | 20-2 | 20-3 | 20-4 |
| Service Rating | A | A | A | D | D | D |
| Number of Contacts | 5 | 5 | 5 | 1 | 3 | 4 |
| Contact Size | 16 | 16 | 16 | 0 | 12 | 12 |



| | | | | | | |
|---------------------------|-------------|---------------------------------------|--------------|------------------------|--------------|--------------|
| Insert Arrangement | 20-6 | 20-7 | 20-8 | 20-9 | 20-11 | 20-12 |
| Service Rating | D | A, B, H, G = D; C, D, E, F = A | Inst. | H = D; Bal. = A | Inst. | A |
| Number of Contacts | 3 | 8 | 2 4 | 1 7 | 13 | 1 1 |
| Contact Size | 16 | 16 | 8 16 | 12 16 | 16 | 4 16 |



| | | | | | | |
|---------------------------|--------------|--------------|--------------|--------------|--------------|--------------|
| Insert Arrangement | 20-14 | 20-15 | 20-16 | 20-17 | 20-18 | 20-19 |
| Service Rating | A | A | A | A | A | A |
| Number of Contacts | 2 3 | 7 | 2 7 | 5 1 | 3 6 | 3 |
| Contact Size | 8 12 | 12 | 12 16 | 12 16 | 12 16 | 8 |



CONTACT LEGEND

16 12 8 4 0

MS/Standard contact arrangements

front face of pin insert or rear face of socket insert illustrated



| | | | | | | |
|--------------------|--------------|--------------|--------------|--------------|--------------|--------------|
| Insert Arrangement | 20-20 | 20-21 | 20-22 | 20-23 | 20-24 | 20-25 |
| Service Rating | A | A | A | A | A | Inst. |
| Number of Contacts | 1 3 | 1 8 | 3 3 | 2 | 2 2 | 13 |
| Contact Size | 4 12 | 12 16 | 8 16 | 8 | 8 16 | 16 |



| | | | | | | |
|--------------------|--------------|--------------|--------------|--------------|-------------|-------------|
| Insert Arrangement | 20-27 | 20-29 | 20-30 | 20-33 | 22-1 | 22-2 |
| Service Rating | A | A | Inst. | A | D | D |
| Number of Contacts | 14 | 17 | 13 | 11 | 2 | 3 |
| Contact Size | 16 | 16 | 16 | 16 | 8 | 8 |

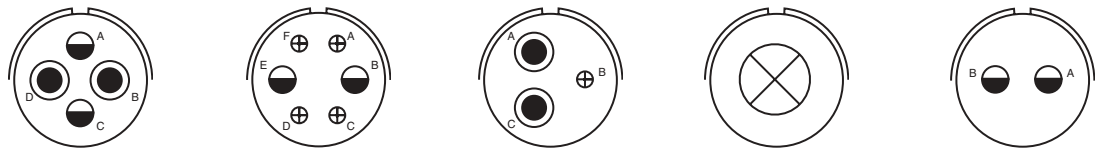

| | | | | | |
|--------------------|-------------|--------------|-------------|-------------|-------------|
| Insert Arrangement | 22-4 | 22-5 | 22-6 | 22-7 | 22-8 |
| Service Rating | A | D | D | E | E |
| Number of Contacts | 2 2 | 2 4 | 2 1 | 1 | 2 |
| Contact Size | 8 12 | 12 16 | 8 16 | 0 | 12 |

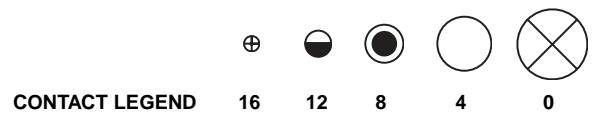

MS/Standard contact arrangements

front face of pin insert or rear face of socket insert illustrated

| | | | | | |
|---------------------------|-------------|--------------|--------------|--------------|------------------------------|
| | | | | | |
| Insert Arrangement | 22-9 | 22-10 | 22-11 | 22-12 | 22-13 |
| Service Rating | E | E | B | D | E = D; A, B, C, D = A |
| Number of Contacts | 3 | 4 | 2 | 2 3 | 4 1 |
| Contact Size | 12 | 16 | 16 | 8 16 | 12 16 |

| | | | | | |
|---------------------------|--------------|---------------------------------|--------------|------------------------|---------------------------------------|
| | | | | | |
| Insert Arrangement | 22-14 | 22-15 | 22-16 | 22-17 | 22-18 |
| Service Rating | A | D = E; A, B, C, E, F = A | A | A = D; Bal. = A | A, B, F, G, H = D; C, D, E = A |
| Number of Contacts | 19 | 5 1 | 3 6 | 1 8 | 8 |
| Contact Size | 16 | 12 16 | 12 16 | 12 16 | 16 |

| | | | | | |
|---------------------------|--------------|--------------|--------------|--------------|------------------------|
| | | | | | |
| Insert Arrangement | 22-19 | 22-20 | 22-21 | 22-22 | 22-23 |
| Service Rating | A | A | A | A | H = D; Bal. = A |
| Number of Contacts | 14 | 9 | 1 2 | 4 | 8 |
| Contact Size | 16 | 16 | 0 16 | 8 | 12 |

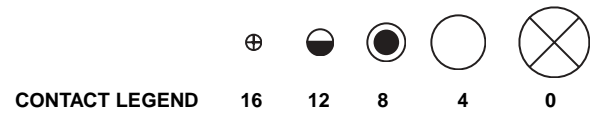

MS/Standard contact arrangements

front face of pin insert or rear face of socket insert illustrated

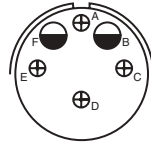

22-24
Service Rating C, D, E = D; A, B, F = A
Number of Contacts 2 4
Contact Size 12 16

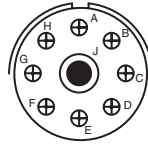

22-27
Service Rating J = D; Bal. = A
Number of Contacts 1 8
Contact Size 8 16

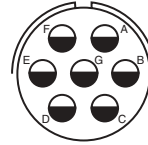

22-28
Service Rating A
Number of Contacts 7
Contact Size 12

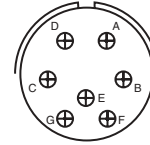

22-33
Service Rating A, B, C, D = D; E, F, G = A
Number of Contacts 7
Contact Size 16

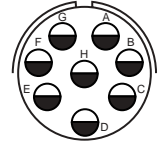

22-36
Service Rating H = D; Bal. = A*
Number of Contacts 8
Contact Size 12

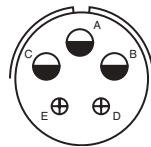

22-34
Service Rating D
Number of Contacts 3 2
Contact Size 12 16

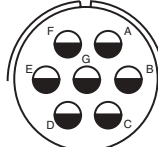

24-2
Service Rating D
Number of Contacts 7
Contact Size 12

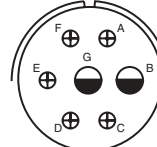

24-3
Service Rating D
Number of Contacts 2 5
Contact Size 12 16

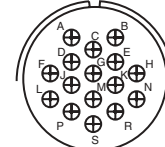

24-5
Service Rating A
Number of Contacts 16
Contact Size 16

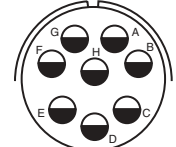

24-6
Service Rating A, G, H = D; Bal. = A
Number of Contacts 8
Contact Size 12

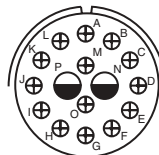

24-7
Service Rating A
Number of Contacts 2 14
Contact Size 12 16

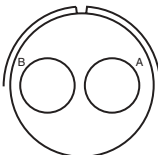

24-9
Service Rating A
Number of Contacts 2
Contact Size 4

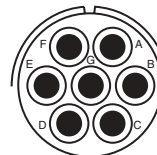

24-10
Service Rating A
Number of Contacts 7
Contact Size 8

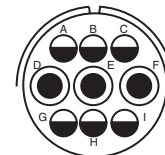

24-11
Service Rating A
Number of Contacts 3 6
Contact Size 8 12

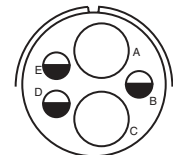

24-12
Service Rating A
Number of Contacts 2 3
Contact Size 4 12

* A, C, E, G = Iron
B, D, F, H = Constantan



MS/Standard contact arrangements

front face of pin insert or rear face of socket insert illustrated



| | | |
|---------------------------|------------------------------|-------|
| Insert Arrangement | 24-16 | |
| Service Rating | A, B, F, G = D; C, D, E, = A | |
| Number of Contacts | 1 | 3 3 |
| Contact Size | 8 | 12 16 |

| | | |
|---------------------------|-------|----|
| Insert Arrangement | 24-17 | |
| Service Rating | D | |
| Number of Contacts | 2 | 3 |
| Contact Size | 12 | 16 |

| | | |
|---------------------------|-------|----|
| Insert Arrangement | 24-20 | |
| Service Rating | D | |
| Number of Contacts | 2 | 9 |
| Contact Size | 12 | 16 |

| | | |
|---------------------------|-------|----|
| Insert Arrangement | 24-21 | |
| Service Rating | D | |
| Number of Contacts | 1 | 9 |
| Contact Size | 8 | 16 |

| | | |
|---------------------------|-------|--|
| Insert Arrangement | 24-22 | |
| Service Rating | D | |
| Number of Contacts | 4 | |
| Contact Size | 8 | |



| | | |
|---------------------------|-------|--|
| Insert Arrangement | 24-27 | |
| Service Rating | E | |
| Number of Contacts | 7 | |
| Contact Size | 16 | |

| | | |
|---------------------------|-------|--|
| Insert Arrangement | 24-28 | |
| Service Rating | Inst. | |
| Number of Contacts | 24 | |
| Contact Size | 16 | |

| | | |
|---------------------------|-----------------------|----|
| Insert Arrangement | 28-1 | |
| Service Rating | A, J, E = D; Bal. = A | |
| Number of Contacts | 3 | 6 |
| Contact Size | 8 | 12 |

| | | |
|---------------------------|------|----|
| Insert Arrangement | 28-2 | |
| Service Rating | D | |
| Number of Contacts | 2 | 12 |
| Contact Size | 12 | 16 |

| | | |
|---------------------------|------|--|
| Insert Arrangement | 28-3 | |
| Service Rating | E | |
| Number of Contacts | 3 | |
| Contact Size | 8 | |

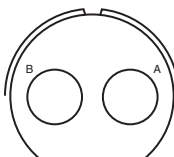
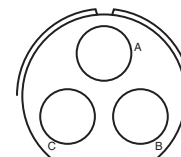
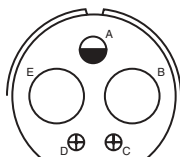
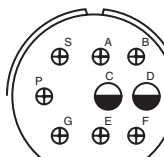

| | | |
|---------------------------|-----------------------|----|
| Insert Arrangement | 28-4 | |
| Service Rating | G, P, S = E; Bal. = D | |
| Number of Contacts | 2 | 7 |
| Contact Size | 12 | 16 |

| | | |
|---------------------------|------|-------|
| Insert Arrangement | 28-5 | |
| Service Rating | D | |
| Number of Contacts | 2 | 1 2 |
| Contact Size | 4 | 12 16 |

| | | |
|---------------------------|------|--|
| Insert Arrangement | 28-6 | |
| Service Rating | D | |
| Number of Contacts | 3 | |
| Contact Size | 4 | |

| | | |
|---------------------------|------|--|
| Insert Arrangement | 28-7 | |
| Service Rating | D | |
| Number of Contacts | 2 | |
| Contact Size | 4 | |



MS/Standard contact arrangements

front face of pin insert or rear face of socket insert illustrated



| | |
|---------------------------|---------------------------|
| Insert Arrangement | 28-8 |
| Service Rating | L, M = E; B = D; Bal. = A |
| Number of Contacts | 2 10 |
| Contact Size | 12 16 |

| |
|-------------|
| 28-9 |
| D |
| 6 6 |
| 12 16 |

| |
|-----------------|
| 28-10 |
| G = D; Bal. = A |
| 2 2 3 |
| 4 8 12 |

| |
|--------------|
| 28-11 |
| A |
| 4 18 |
| 12 16 |

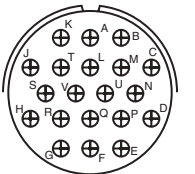
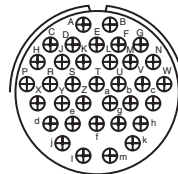
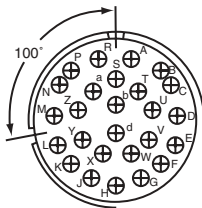

| | |
|---------------------------|--------------|
| Insert Arrangement | 28-12 |
| Service Rating | A |
| Number of Contacts | 26 |
| Contact Size | 16 |

100° Rotation
of 28-12

| |
|--------------|
| 28-13 |
| A |
| 26 |
| 16 |

| |
|--------------|
| 28-15 |
| A |
| 35 |
| 16 |

| |
|--------------|
| 28-16 |
| A |
| 20 |
| 16 |

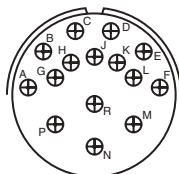

| | |
|---------------------------|--------------------------------|
| Insert Arrangement | 28-17 |
| Service Rating | R = B; M, N, P = D; A to L = A |
| Number of Contacts | 15 |
| Contact Size | 16 |

| |
|--|
| 28-18 |
| M = C; G, H, J, K, L = D; A, B = A; Bal. = Inst. |
| 12 |
| 16 |

| |
|------------------------------|
| 28-19 |
| H, M = B; A, B = D; Bal. = A |
| 4 6 |
| 12 16 |

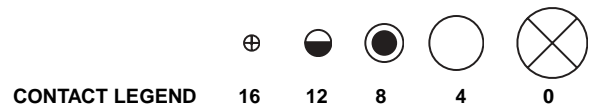

MS/Standard contact arrangements

front face of pin insert or rear face of socket insert illustrated

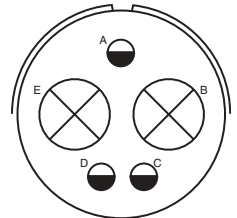
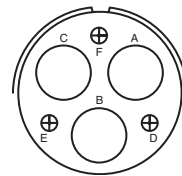
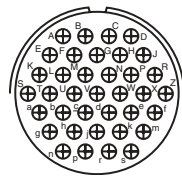
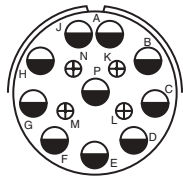

Insert Arrangement
Service Rating
Number of Contacts
Contact Size

28-20
A
10 4
12 16

28-21
A
37
16

28-22
D
3 3
4 16

32-1
A = E; B, C, D, E = D
2 3
0 12

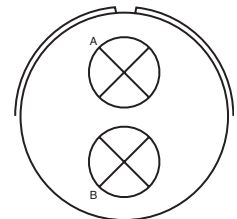
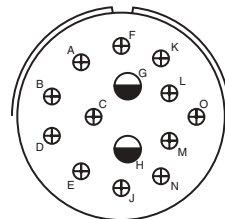
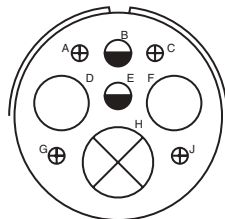
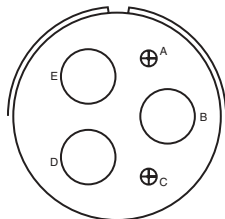

Insert Arrangement
Service Rating
Number of Contacts
Contact Size

32-2
E
3 2
4 16

32-3
D
1 2 2 4
0 4 12 16

32-4
F, J, K, N = A; Bal. = D
2 12
12 16

32-5
D
2
0

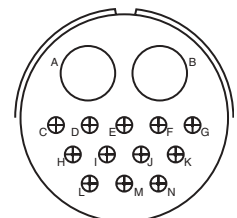
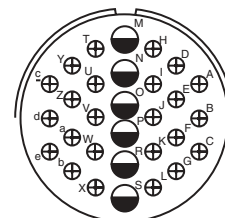
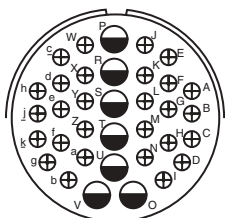
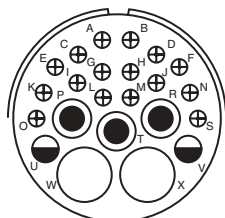

Insert Arrangement
Service Rating
Number of Contacts
Contact Size

32-6
A
2 3 2 16
4 8 12 16

32-7
A, B, h, j = Inst.; Bal. = A
7 28
12 16

32-8
A
6 24
12 16

32-9
D
2 12
4 16



CONTACT LEGEND

16 12 8 4 0

MS/Standard contact arrangements

front face of pin insert or rear face of socket insert illustrated

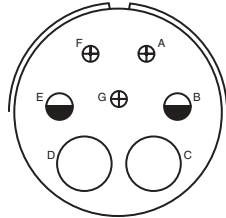

32-10

Insert Arrangement

Service Rating

Number of Contacts

Contact Size

A, F = E; G = B; B, E = D; C, D = A

2 2 3

4 8 16

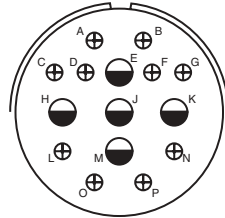

32-12

C, D, E, F, G = A; Bal. = D

5 10

12 16

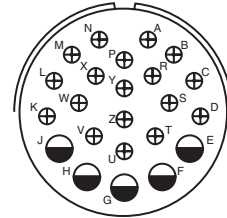

32-13

D

5 18

12 16

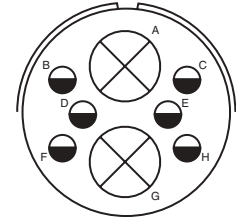

32-15

D

2 6

0 12

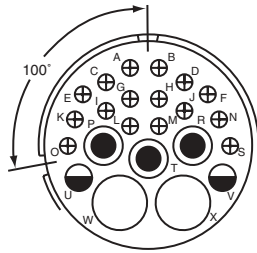

100° Rotation
of 32-6

32-16

Insert Arrangement

Service Rating

Number of Contacts

Contact Size

A

2 3 2 16

4 8 12 16

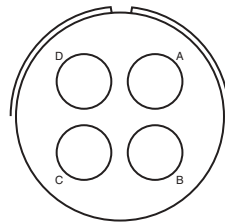

32-17

D

4

4

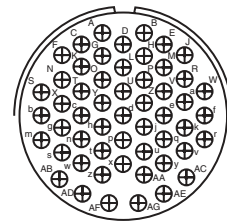

32-22

A

54

16

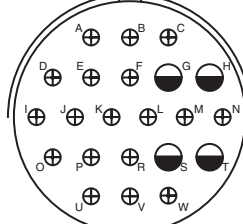

36-1

D

4 18

12 16

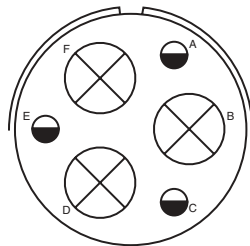

36-3

Insert Arrangement

Service Rating

Number of Contacts

Contact Size

D

3 3

0 12

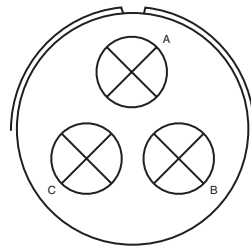

36-4

A = D; B, C = A

3

0

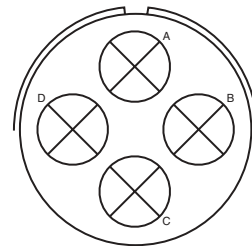

36-5

A

4

0

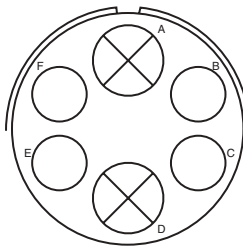

36-6

A

2 4

0 4

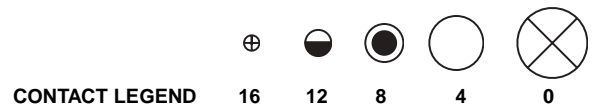

MS/Standard contact arrangements

front face of pin insert or rear face of socket insert illustrated



Insert Arrangement 36-7
Service Rating A
Number of Contacts 7 40
Contact Size 12 16

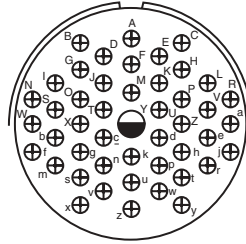

Insert Arrangement 36-8
Service Rating A
Number of Contacts 1 46
Contact Size 12 16

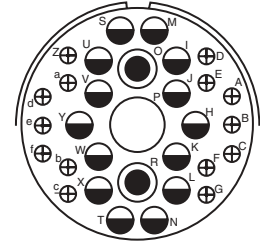

Insert Arrangement 36-9
Service Rating A
Number of Contacts 1 2 14 14
Contact Size 4 8 12 16

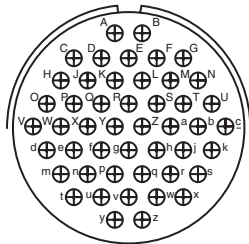

Insert Arrangement 36-10
Service Rating A
Number of Contacts 48
Contact Size 16

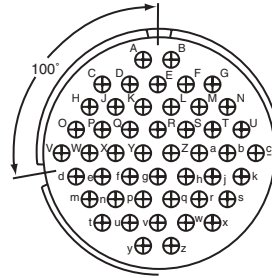

100° Rotation
of 36-10
Insert Arrangement 36-11
Service Rating A
Number of Contacts 48
Contact Size 16

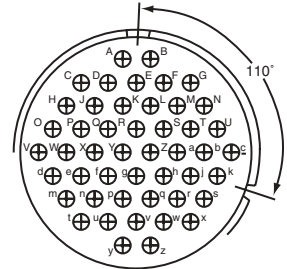

110° Rotation
of 36-10
Insert Arrangement 36-12
Service Rating A
Number of Contacts 48
Contact Size 16

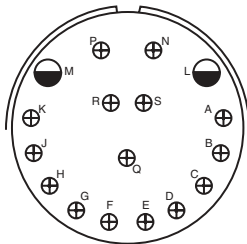

Insert Arrangement 36-13
Service Rating N, P, Q = E; Bal. = A
Number of Contacts 2 15
Contact Size 12 16

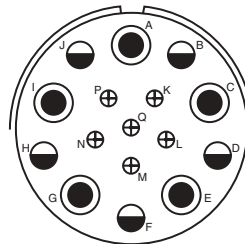

Insert Arrangement 36-14
Service Rating D
Number of Contacts 5 5 6
Contact Size 8 12 16

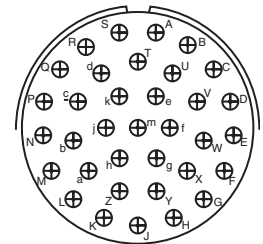

Insert Arrangement 36-15
Service Rating M = D; Bal. = A
Number of Contacts 35
Contact Size 16

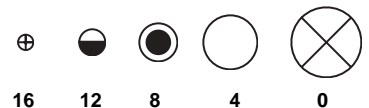

CONTACT LEGEND

16 12 8 4 0

MS/Standard contact arrangements

front face of pin insert or rear face of socket insert illustrated

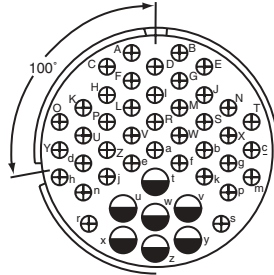

100° Rotation
of 36-7
36-16
A
7 40
12 16

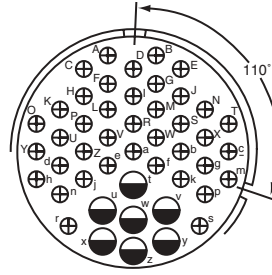

110° Rotation
of 36-7
36-17
A
7 40
12 16

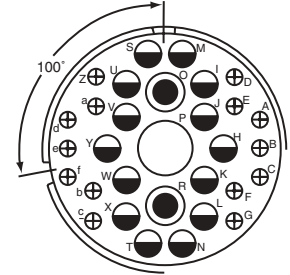

100° Rotation
of 36-9
36-18
A
1 2 14 14
4 8 12 16

Insert Arrangement
Service Rating
Number of Contacts
Contact Size

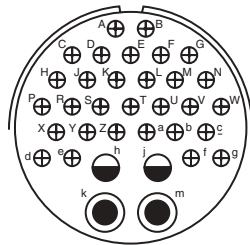

36-20
A
2 2 30
8 12 16

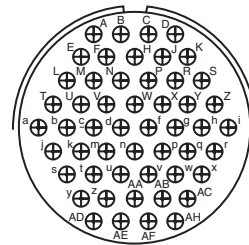

36-52
A
52
16

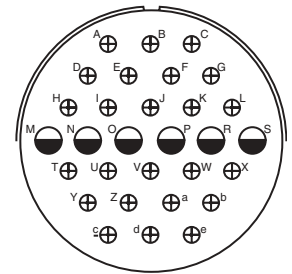

40-1
D
6 24
12 16

Insert Arrangement
Service Rating
Number of Contacts
Contact Size

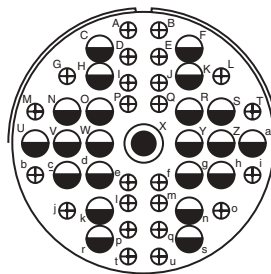

40-9
A
1 22 24
8 12 16

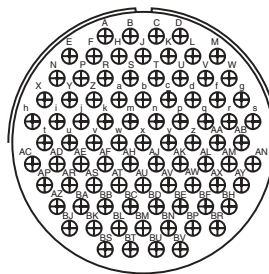

40-56
A
85
16

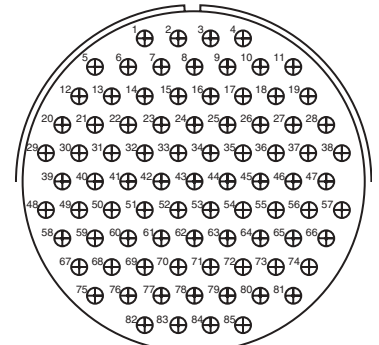

48-62
D
85
16

Insert Arrangement
Service Rating
Number of Contacts
Contact Size



CONTACT LEGEND

16 12 8 4 0

Special contact arrangements

Requirements for more complex circuits prompted Amphenol to provide inserts not covered by the MS drawings. Illustrated here and on the following pages are insert layouts which have from one contact (high tension) to the 104 contact insert in shell size 44.

Many of these special inserts are also available in alternate keyway arrangements. Please contact Amphenol, Sidney, NY for additional information on special circuit application requirements.

front face of pin insert or rear face of socket insert illustrated

| | | | | | | |
|---------------------------|--------|-------|-------|-------|-----------------------|-------|
| | | | | | | |
| Insert Arrangement | 14S-A7 | 16-59 | 20-26 | 20-51 | 20-57 | 20-58 |
| Service Rating | A | A | A | A | A | A |
| Number of Contacts | 7 | 4 | 19 | 3* | 7* | 5 5 |
| Contact Size | 16 | 12 | 16 | 8 | 12 for #14 or 16 wire | 12 16 |

| | | | | | | |
|---------------------------|----------------------|--------------------|--------------------|-------|-----------------------|-------|
| | | | | | | |
| Insert Arrangement | 20-59 | 20-66 | 20-79 | 22-63 | 22-65 | 22-70 |
| Service Rating | A | A | H = D; Bal. = A | A | H = D; Bal. = A | A |
| Number of Contacts | 3* | 1 5 | 7* 1* | 4 8 | 8* | 8 5 |
| Contact Size | 8 for #10 or 12 wire | 16 12 for #10 wire | 16 12 for #16 wire | 12 16 | 12 for #14 or 16 wire | 12 16 |

| | | | | | | |
|---------------------------|----------------------|-------|--|---------|-------|---------|
| | | | | | | |
| Insert Arrangement | 22-80 | 24-19 | 24-51 | 24-52 | 24-53 | 24-58 |
| Service Rating | A | A | A | Hi-Volt | A | A |
| Number of Contacts | 3* | 12 | 5* | 1 | 5* | 3 3 7 |
| Contact Size | 8 for #10 or 12 wire | 16 | B, E for AN #10 or 12 wire A, C, D for AN #8 wire | 12 | 8 | 8 12 16 |

* Solderless

| | | | | | |
|-----------------------|----|----|---|---|---|
| | | | | | |
| CONTACT LEGEND | 16 | 12 | 8 | 4 | 0 |

Special contact arrangements

front face of pin insert or rear face of socket insert illustrated

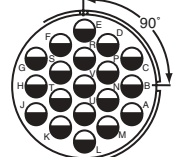
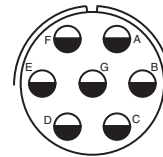

| | | | | | |
|--------------------|-------|----------------------|-------|-------|-------|
| Insert Arrangement | 24-59 | 24-60 | 24-65 | 24-66 | 24-67 |
| Service Rating | A | A | A | D | Inst. |
| Number of Contacts | 7 7 | 7* | 11 4 | 7 | 19 |
| Contact Size | 12 16 | 8 for #10 or 12 wire | 12 16 | 12 | 12 |



| | | | | | |
|--------------------|------------------------|------------------|-------|-------|-----------------------------------|
| Insert Arrangement | 24-71 | 24-75 | 24-79 | 24-80 | 24-84 |
| Service Rating | A | A | A | Inst. | A |
| Number of Contacts | 2* 5* | 5 2 | 5 | 23 | 1 18 |
| Contact Size | 8 8 for #10 or 12 wire | 8 8 for #16 wire | 8 | 16 | 12 12 (Coax) RG-188/U or RG-174/U |



| | | | | |
|--------------------|-------|-------|-------|-------|
| Insert Arrangement | 24-96 | 24-AJ | 28-51 | 28-59 |
| Service Rating | Inst. | A | A | A |
| Number of Contacts | 28 | 25 | 12 | 7 10 |
| Contact Size | 16 | 16 | 12 | 12 16 |

* Solderless



Special contact arrangements

front face of pin insert or rear face of socket insert illustrated

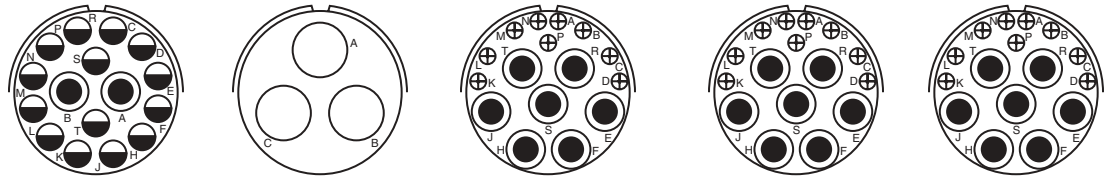

| Insert Arrangement | 28-66 | 28-72 | 28-74 | 28-75 | 28-79 |
|--------------------|-------|-------------------------------|-------------------------------|-------------------|-------|
| Service Rating | A | — | A | A | A |
| Number of Contacts | 2 14 | 3 | 9* 4* 3* | 9* 7* | 7 9 |
| Contact Size | 8 12 | 4 (Coax) RG-59A/U or RG-62A/U | 16 8 8 for #10 wire (S, T, R) | 16 8 for #10 wire | 8 16 |

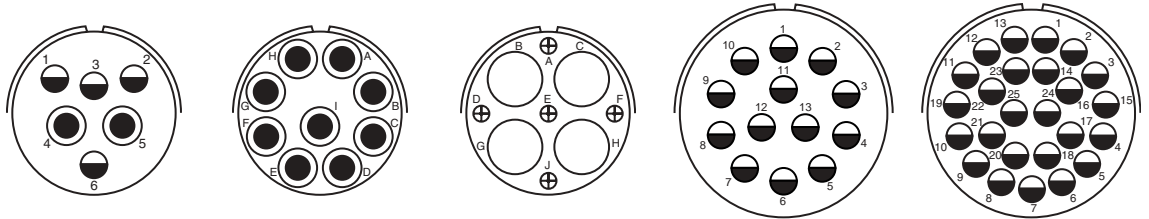

| Insert Arrangement | 28-82 | 28-84 | 28-AY | 32-14 | 32-25 |
|--------------------|-------|-------|-------|-------|-------|
| Service Rating | D | A | A | D | A |
| Number of Contacts | 2 4 | 9 | 4 5 | 13 | 25 |
| Contact Size | 8 12 | 8 | 4 16 | 12 | 12 |

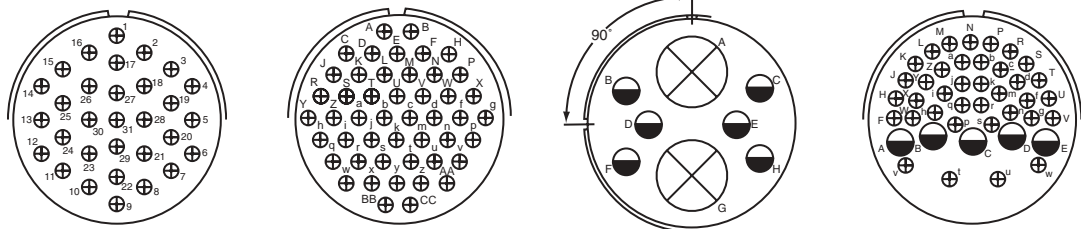

| Insert Arrangement | 32-31 | 32-48 | 32-52 | 32-53 |
|--------------------|-------|-------|-------|------------------------|
| Service Rating | A | Inst. | D | t, u = E; Bal. = Inst. |
| Number of Contacts | 31 | 48 | 6 2 | 5 37 |
| Contact Size | 16 | 16 | 12 0 | 12 16 |

* Solderless

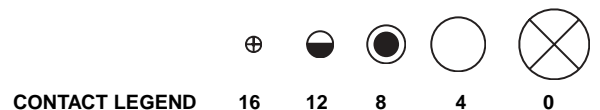

Special contact arrangements

front face of pin insert or rear face of socket insert illustrated

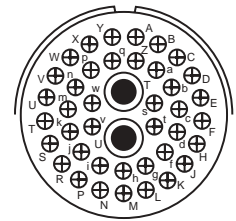
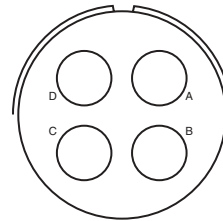
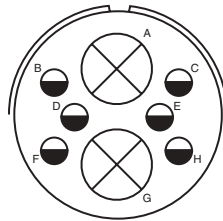
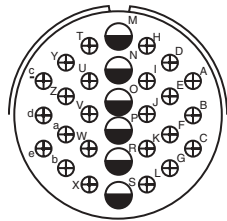

| | | | | |
|---------------------------|--------------------|---------------------|-------------------------------|----------------------|
| Insert Arrangement | 32-56 | 32-57 | 32-58 | 32-59 |
| Service Rating | A | ** | - | A |
| Number of Contacts | 24 6 | 6 2 | 4 | 40 2 |
| Contact Size | 16 12 for #10 wire | 12 0 (Coax) RG-71/U | 4 (Coax) RG-161/U or RG-179/U | 16 8 (Coax) RG-161/U |

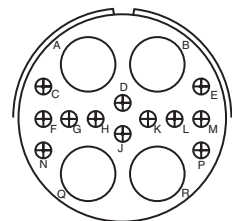
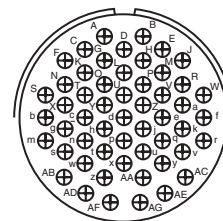
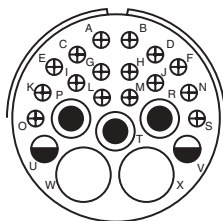
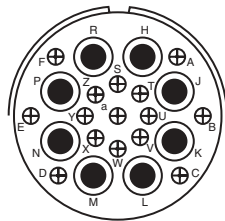

| | | | | |
|---------------------------|----------------------|-----------------------------|--------------|----------------------|
| Insert Arrangement | 32-60 | 32-62 | 32-64 | 32-68 |
| Service Rating | A | ** | Inst. | A |
| Number of Contacts | 15 8 | 2 1 2 16 2 | 54 | 12 4 |
| Contact Size | 16 8 (Coax) RG-124/U | 4 8 12 16 8 (Coax) RG-124/U | 16 | 16 4 (Coax) RG-58C/U |

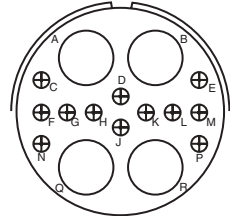
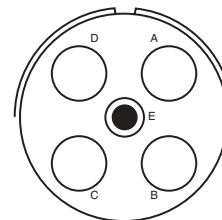
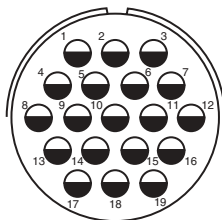
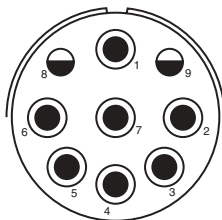
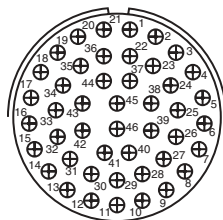

| | | | | | |
|---------------------------|--------------|-----------------------|--------------|--------------|--------------|
| Insert Arrangement | 32-73 | 32-75 | 32-76 | 32-79 | 32-82 |
| Service Rating | A | 8, 9 = D | A | D | A |
| Number of Contacts | 46 | 2 7 | 19 | 4 1 | 4 12 |
| Contact Size | 16 | 12 8 (Coax) RG-180B/U | 12 | 4 8 | 4 16 |

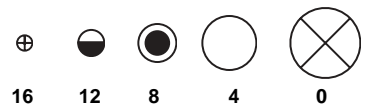

** Consult Amphenol, Sidney, NY for service rating of power contacts.

Special contact arrangements

front face of pin insert or rear face of socket insert illustrated



| | | | | |
|--------------------|-------|-------|-------|-------|
| Insert Arrangement | 32-AF | 36-22 | 36-51 | 36-54 |
| Service Rating | A | D | D | A |
| Number of Contacts | 55 | 22 | 2 2 | 8 31 |
| Contact Size | 16 | 12 | 0 4 | 8 16 |

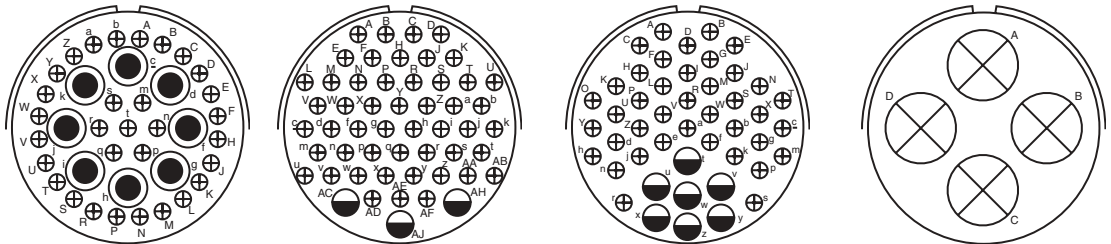

| | | | | |
|--------------------|------------------|--------------------|--------------------|--------------------------------------|
| Insert Arrangement | 36-55 | 36-59 | 36-60 | 36-64 |
| Service Rating | A | A | ** | - |
| Number of Contacts | 31 8 | 50 3 | 40 7 | 4 |
| Contact Size | 16 8 for #6 wire | 16 12 for #10 wire | 16 12 for #10 wire | 0 (Coax) RG-11/U, RG-12/U or RG-13/U |

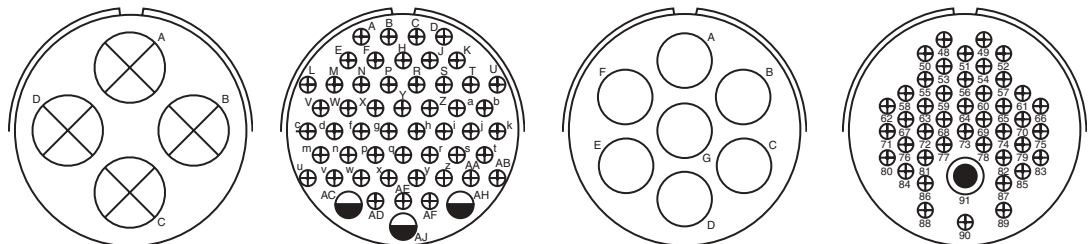

| | | | | |
|--------------------|--------------------------------------|-------|-------------------|----------------------|
| Insert Arrangement | 36-65 | 36-71 | 36-73 | 36-74 |
| Service Rating | - | A | - | A |
| Number of Contacts | 4 | 3 50 | 7 | 43 1 |
| Contact Size | 0 (Coax) RG-59/U, RG-62/U or RG-71/U | 12 16 | 4 (Coax) RG-62B/U | 16 8 (Coax) RG-187/U |

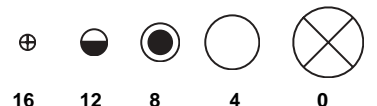

** Consult Amphenol, Sidney, NY for service rating of power contacts.

Special contact arrangements

front face of pin insert or rear face of socket insert illustrated



| | | | | |
|---------------------------|-----------------|--------------|--------------|--------------|
| Insert Arrangement | 36-75 | 36-76 | 36-77 | 36-78 |
| Service Rating | A | A | D | A |
| Number of Contacts | 48 | 47 | 7 | 2 12 |
| Contact Size | 16 for #14 wire | 16 | 4 | 16 8 |

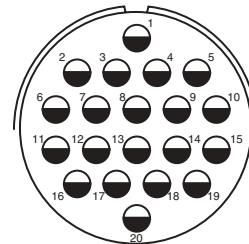

| | | | | |
|---------------------------|--------------|-----------------|------------------|-----------------|
| Insert Arrangement | 36-79 | 36-80 | 36-83 | 36-85 |
| Service Rating | A | A | - | M = D; Bal. = A |
| Number of Contacts | 20 | 20 | 7 | 35 |
| Contact Size | 12 | 12 for #10 wire | 4 (Coax) RG-58/U | 16 for #12 wire |



| | | | | |
|---------------------------|--------------|--------------|--------------|-------------|
| Insert Arrangement | 36-97 | 36-99 | 36-AF | 40-5 |
| Service Rating | C | D | A | A |
| Number of Contacts | 1 | 3 3 3 3 | 48 | 5 |
| Contact Size | 4/0 | 4 8 12 16 | 16 | 0 |



Special contact arrangements

front face of pin insert or rear face of socket insert illustrated

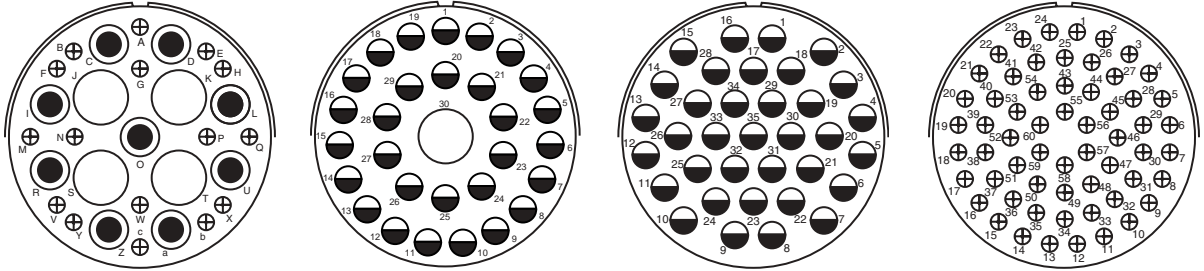

| Insert Arrangement | 40-10 | 40-30 | 40-35 | 40-53 |
|--------------------|--------|-------|-------|-------|
| Service Rating | A | A | D | A |
| Number of Contacts | 4 9 16 | 29 1 | 35 | 60 |
| Contact Size | 4 8 16 | 12 4 | 12 | 16 |

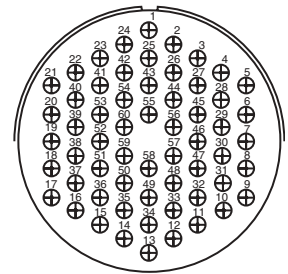
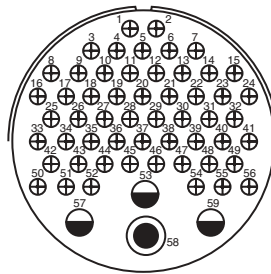
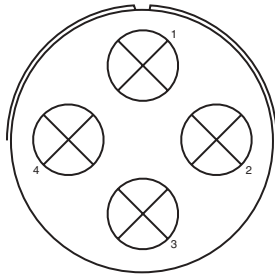

| Insert Arrangement | 40-57 | 40-61 | 40-62 |
|--------------------|-------|---------|-------|
| Service Rating | E | A | A |
| Number of Contacts | 4 | 1 3 55 | 60 |
| Contact Size | 0 | 8 12 16 | 16 |

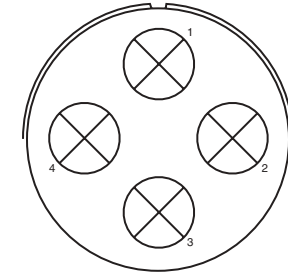
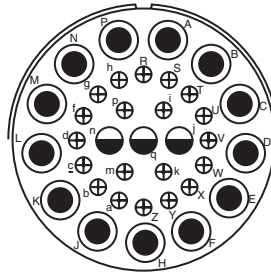
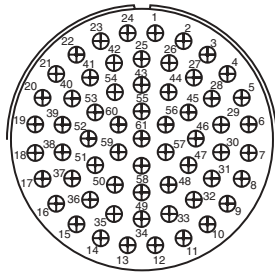

| Insert Arrangement | 40-63 | 40-64 | 40-66 |
|--------------------|-----------------|-------------------------|-------------------|
| Service Rating | A | - | - |
| Number of Contacts | 61 | 3 20 13 | 4 |
| Contact Size | 16 for #14 wire | 12 16 8 (Coax) RG-124/U | 0 (Coax) RG-63B/U |



Special contact arrangements

front face of pin insert or rear face of socket insert illustrated



Insert Arrangement 40-67
Service Rating A
Number of Contacts 1 10
Contact Size 16 4 (Coax) RG-59/U

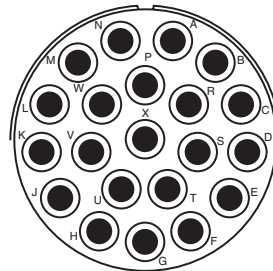

Insert Arrangement 40-68
Service Rating A
Number of Contacts 21 8

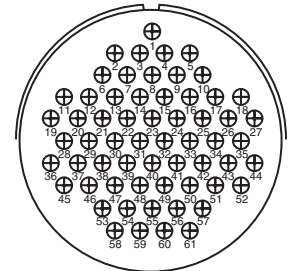

Insert Arrangement 40-70
Service Rating A
Number of Contacts 61 16

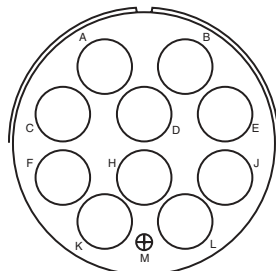

Insert Arrangement 40-72
Service Rating A
Number of Contacts 1 10
Contact Size 16 4 (Coax) RG-9B/U

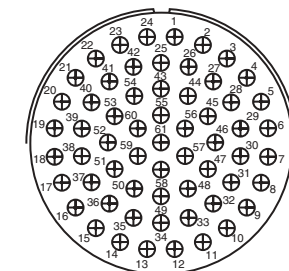

Insert Arrangement 40-73
Service Rating A
Number of Contacts 61 16

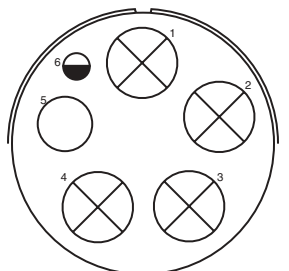

Insert Arrangement 40-74
Service Rating A
Number of Contacts 1 1 4
Contact Size 12 4 (Coax) RG-62/U 0 (Coax) RG-9B/U or RG-214/U

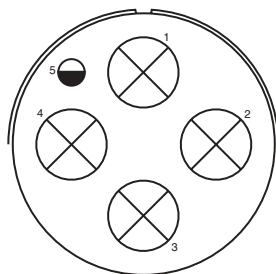

Insert Arrangement 40-75
Service Rating E
Number of Contacts 1 4
Contact Size 12 0

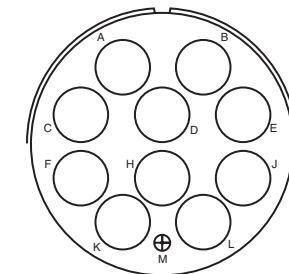

Insert Arrangement 40-80
Service Rating A
Number of Contacts 1 10
Contact Size 16 4

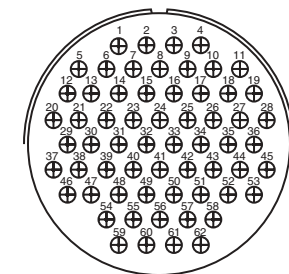

Insert Arrangement 40-81
Service Rating A
Number of Contacts 62
Contact Size 16 for #14 wire

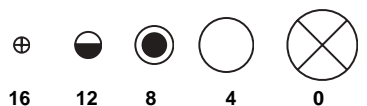

CONTACT LEGEND

16 12 8 4 0

Special contact arrangements

front face of pin insert or rear face of socket insert illustrated

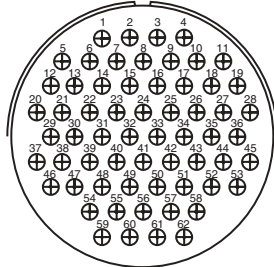

40-82

Insert Arrangement
Service Rating
Number of Contacts
Contact Size

A
62
16

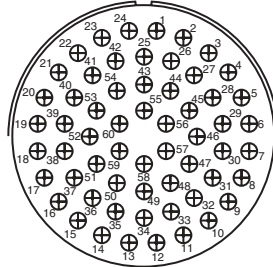

40-85

A
60
16 for #14 wire



40-86

-
4
0(Coax) RG-115A/U

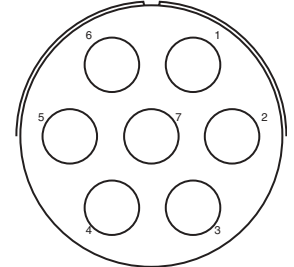

40-87

D
7
4

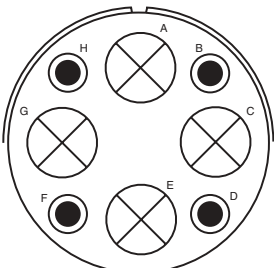

40-AD

Insert Arrangement
Service Rating
Number of Contacts
Contact Size

A
4 4
8 0

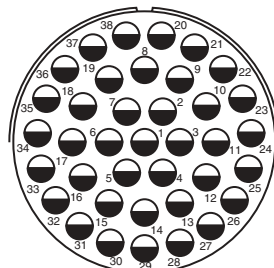

40-AG

A
38
12



40-AP

E
2
4/0

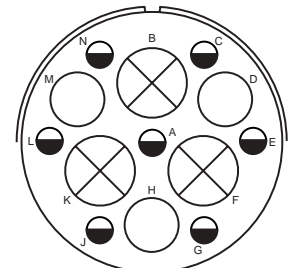

40-AR

Inst.
7 3 3
12 4 0

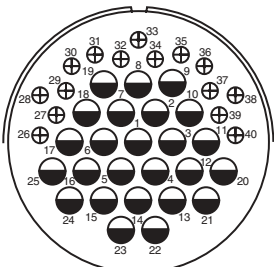

40-AS

Insert Arrangement
Service Rating
Number of Contacts
Contact Size

A
15 25
16 12

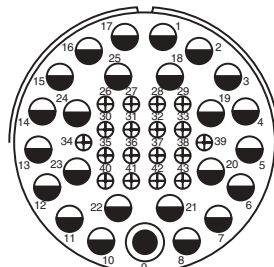

40-AT

A
24 18 1
12 16 8



40-AU

A
3 10 1
4 8 16

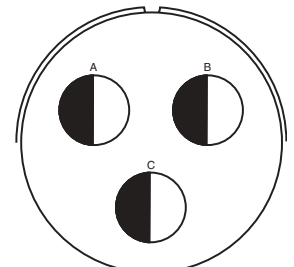

40-AV

D
3
2/0

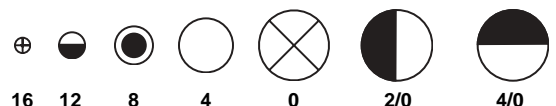

CONTACT LEGEND

16 12 8 4 0 2/0 4/0

Special contact arrangements

front face of pin insert or rear face of socket insert illustrated



| Insert Arrangement | 44-52 | 44-53 | 48-51 |
|--------------------|-------|----------------------|-----------------------|
| Service Rating | A | A | A |
| Number of Contacts | 104 | 18 18 | 42 10 4 |
| Contact Size | 16 | 16 8 (Coax) RG-124/U | 16 8 0 (Coax) RG-41/U |

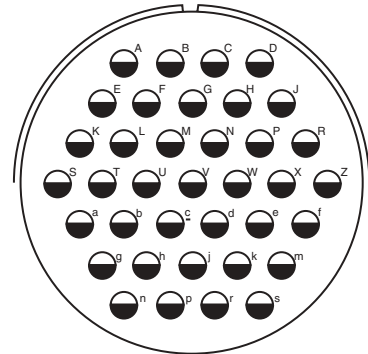

| Insert Arrangement | 48-52 | 48-53 |
|--------------------|---------------------|-------|
| Service Rating | A | D |
| Number of Contacts | 56 5 | 37 |
| Contact Size | 16 0 (Coax) RG-41/U | 12 |



Special contact arrangements

front face of pin insert or rear face of socket insert illustrated



48-54

Insert Arrangement
Service Rating
Number of Contacts
Contact Size

A
42 10 4
16 8 0 (Coax) RG-59/U

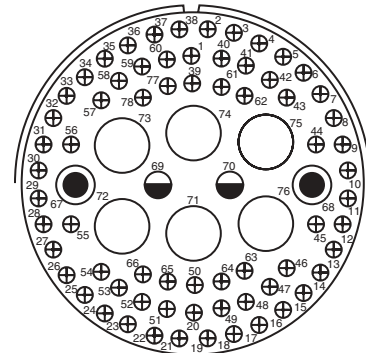

48-55

A
68 2 2 6
16 12 8 4

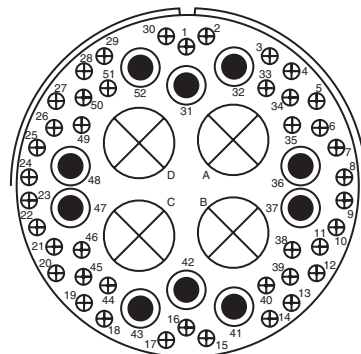

48-57

Insert Arrangement
Service Rating
Number of Contacts
Contact Size

A
42 10 4
16 8 0

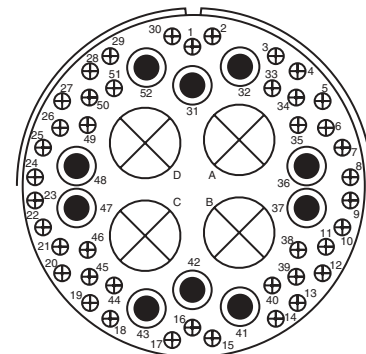

48-60

A
42 10 4
16 8 0 (Coax) RG-214/U



CONTACT LEGEND 16 12 8 4 0

Thermocouple contact availability

A complete line of cylindrical connectors containing thermocouple insert arrangements is available. The contact layout for a particular arrangement will be found in either the MS/Standard contact arrangement section, pages 26-37, or the Special contact arrangement section, pages 38-48. All thermocouple contact layouts may contain either iron, alumel, chromel, constantan, standard (copper) or brass (dummy) contacts. See the thermocouple tabulations on the following pages.

The following abbreviations are used in the contact material column in the charts that follow. Also, thermocouple contacts are color coded as shown. (This identification is made by means of small dots of stain on the solder well end of the contact).

| Abbreviation | Material | Color Code |
|--------------|--------------|------------|
| Ir. | Iron | Black |
| Con. | Constantan | Yellow |
| Cu. | Copper Alloy | N/A |
| Ch. | Chromel | White |
| Al. | Alumel | Green |
| Dummy | Brass | N/A |

WIRE WELL DATA

| Contact Size | Well Inside Dia. +.004 -.002 | Well Depth +.031 -.000 | Solder Well Barrel Outside Dia. |
|--------------|------------------------------------|------------------------------|------------------------------------|
| 12 | .125 | .250 | .166 ±.003 |
| 16 | .094 | .188 | .125 ^{+.002} -.004 |

RECOMMENDED WIRE

| | |
|----------------------|--|
| I Chromel - Alumel | Use wire in accordance with MIL-W-5848 |
| II Iron - Constantan | Use wire in accordance with MIL-W-5845 |

Thermocouple contact arrangements

| Shell Size and Arrg. | Similar to MS Arrg. | Total Contacts | Contact Size | | Pin Insert Rotation C W | Contact Material |
|----------------------|---------------------|----------------|--------------|----|-------------------------|---|
| | | | 12 | 16 | | |
| 10SL-51 | 10SL-4 | 2 | | 2 | 45° | A = Ir.; B = Con. |
| 10SL-52 | 10SL-4 | 2 | | 2 | 45° | A = Cu.; B = Con. |
| 10SL-53 | 10SL-4 | 2 | | 2 | 45° | A = Al.; B = Ch. |
| 10SL-54 | 10SL-3 | 3 | | 3 | None | A = Ir.; B = Con.; C = Cu. |
| 10SL-55 | 10SL-3 | 3 | | 3 | None | A = Al.; B = Ch.; C = Cu. |
| 10SL-56 | 10SL-4 | 2 | | 2 | None | A = Al.; B = Ch. |
| 10SL-57 | 10SL-4 | 2 | | 2 | None | A = Ch.; B = Con. |
| 10SL-58 | 10SL-3 | 3 | | 3 | None | A = Ch.; B = Al.; C = Cu. |
| 10SL-59 | 10SL-4 | 2 | | 2 | None | A = Ch.; B = Al. |
| 10SL-60 | 10SL-4 | 2 | | 2 | None | A = Ir.; B = Con. |
| 10SL-61 | 10SL-4 | 2 | | 2 | None | A = Cu.; B = Con. |
| 10SL-62 | 10SL-3 | 3 | | 3 | None | A = Cu.; B = Al.; C = Ir. |
| 10SL-63 | 10SL-3 | 3 | | 3 | None | A, C = Con.; B = Ch. |
| 10SL-64 | 10SL-3 | 3 | | 3 | None | A, C = Ch.; B = Al. |
| | | | | | | |
| 12S-51 | 12S-3 | 2 | | 2 | 315° | A = Ch.; B = Al. |
| 12S-54 | 12S-3 | 2 | | 2 | 315° | A = Ir.; B = Con. |
| 12S-55 | 12S-3 | 2 | | 2 | 45° | A = Cu.; B = Con. |
| 12S-56 | 12S-3 | 2 | | 2 | None | A = Al.; B = Ch. |
| 12S-57 | 12S-3 | 2 | | 2 | 60° | A = Ch.; B = Al. |
| 12S-58 | 12S-3 | 2 | | 2 | 120° | A = Ir.; B = Con. |
| 12S-59 | 12S-3 | 2 | | 2 | None | A = Ir.; B = Con. |
| 12S-60 | 12S-3 | 2 | | 2 | None | A = Cu.; B = Con. |
| 12S-61 | 12S-3 | 2 | | 2 | None | A = Ch.; B = Con. |
| 12S-62 | 12S-3 | 2 | | 2 | None | A = Ch.; B = Al. |
| | | | | | | |
| 14S-51 | 14S-9 | 2 | | 2 | 90° | A = Al.; B = Ch. |
| 14S-52 | 14S-2 | 4 | | 4 | 45° | A, B = Cu.; C = Al.; D = Ch. |
| 14S-53 | 14S-9 | 2 | | 2 | 90° | A = Ir.; B = Con. |
| 14S-54 | 14S-6 | 6 | | 6 | 45° | A, C, E = Ir.; B, D, F = Con. |
| 14S-55 | 14S-2 | 4 | | 4 | 45° | A, C = Ir.; B, D = Con. |
| 14S-56 | 14S-2 | 4 | | 4 | 45° | A = Ir.; B = Con.; C, D = Cu. |
| 14S-57 | 14S-2 | 4 | | 4 | 45° | A, C = Al.; B, D = Ch. |
| 14S-58 | 14S-7 | 3 | | 3 | 45° | A = Al.; B = Ch.; C = Cu. |
| 14S-59 | 14S-9 | 2 | | 2 | 90° | A = Cu.; B = Con. |
| 14S-60 | 14S-9 | 2 | | 2 | None | A = Al.; B = Ch. |
| 14S-61 | 14S-6 | 6 | | 6 | 45° | A = Al.; B = Ch.; C = Ir.; D = Con.; E, F = Cu. |
| 14S-63 | 14S-6 | 6 | | 6 | None | A, C = Al.; B, D = Ch.; E = Ir.; F = Con. |
| 14S-64 | 14S-2 | 4 | | 4 | None | A, C = Con.; B, D = Cu. |
| 14S-65 | 14S-6 | 6 | | 6 | None | A, C, E = Cu.; B, D, F = Con. |
| 14S-67 | 14S-6 | 6 | | 6 | None | A = Al.; B = Ch.; Balance = Cu. |
| 14S-68 | 14S-2 | 4 | | 4 | 45° | A = Ch.; B = Con.; C, D = Cu. |
| 14S-69 | 14S-7 | 3 | | 3 | None | A = Con.; B = Ch.; C = Cu. |
| 14S-70 | 14S-2 | 4 | | 4 | None | A, D = Ch.; B, C = Al. |
| 14S-71 | 14S-2 | 4 | | 4 | None | A, B, D = Cu.; C = Con. |
| 14S-72 | 14S-9 | 2 | | 2 | None | A = Con.; B = Cu. |
| 14S-73 | 14S-2 | 4 | | 4 | None | A, B = Cu.; C = Al.; D = Ch. |

Thermocouple contact arrangements

| Shell Size and Arrg. | Similar to MS Arrg. | Total Contacts | Contact Size | | Pin Insert Rotation C W | Contact Material |
|----------------------|---------------------|----------------|--------------|----|-------------------------|---|
| | | | 12 | 16 | | |
| 14S-74 | 14S-2 | 4 | | 4 | None | A, B = Ch.; C, D = Al. |
| 14S-75 | 14S-2 | 4 | | 4 | None | A, B = Cu.; C, D = Con. |
| 14S-76 | 14S-2 | 4 | | 4 | None | A, C = Al.; B, D = Ch. |
| 14S-77 | 14S-2 | 4 | | 4 | None | A, D = Al.; B, C = Ch. |
| 14S-78 | 14S-9 | 2 | | 2 | None | A = Ch.; B = Al. |
| | | | | | | |
| 16S-52 | 16S-4 | 2 | | 2 | None | A = Ch.; B = Al. |
| 16S-54 | 16S-1 | 7 | | 7 | None | A = Al.; B = Ch.; Balance = Cu. |
| 16S-55 | 16S-1 | 7 | | 7 | None | A = Con.; Balance = Cu. |
| | | | | | | |
| 16-52 | 16-11 | 2 | 2 | | 90° | A = Al.; B = Ch. |
| 16-53 | 16-9 | 4 | 2 | 2 | 70° | A = Al.; C = Ch.; B, D = Cu. |
| 16-55 | 16-10 | 3 | 3 | | 45° | A = Al.; B = Ch.; C = Cu. |
| 16-56 | 16-13 | 2 | 2 | | 90° | A = Con.; B = Cu. |
| 16-57 | 16-10 | 3 | 3 | | None | A = Al.; B = Cu.; C = Ch. |
| 16-58 | 16-10 | 3 | 3 | | None | A = Con.; B, C = Cu. |
| 16-60 | 16-13 | 2 | 2 | | None | A = Al.; B = Ch. |
| 16-62 | 16-11 | 2 | 2 | | None | A = Con.; B = Cu. |
| | | | | | | |
| 18-51 | 18-12 | 6 | | 6 | None | A = Ir.; B, E = Con.; D = Cu.; C, F = Dummy |
| 18-52 | 18-11 | 5 | 5 | | None | A = Ir.; B = Con.; C = Ch.; D = Al.; E = Dummy |
| 18-53 | 18-12 | 6 | | 6 | None | A, D = Ir.; B, E = Con.; C, F = Dummy |
| 18-54 | 18-15 | 4 | 4 | | None | A, C = Al.; B, D = Ch. |
| 18-56 | 18-1 | 10 | | 10 | 45° | A, C, E, G, I = Ir.; B, D, F, H, J = Con. |
| 18-57 | 18-12 | 6 | | 6 | 45° | A, C, E = Al.; B, D, F = Ch. |
| 18-59 | 18-12 | 6 | | 6 | 45° | A, C = Ir.; B, E, F = Con.; D = Cu. |
| 18-60 | 18-11 | 5 | 5 | | 45° | A, D = Al.; B, C, = Ch.; E = Cu. |
| 18-61 | 18-12 | 6 | | 6 | None | A, C = Ir.; B, D = Con.; E = Ch.; F = Al. |
| 18-62 | 18-12 | 6 | | 6 | None | A, B, C = Ir.; D, E, F = Con. |
| 18-63 | 18-15 | 4 | 4 | | None | A, C = Con.; B, D = Cu. |
| 18-65 | 18-12 | 6 | | 6 | None | A = Ir.; B = Con.; Balance = Cu. |
| 18-66 | 18-1 | 10 | | 10 | None | A, C, E, G, I = Cu.; B, D, F, H, J = Con. |
| 18-67 | 18-12 | 6 | | 6 | None | A, C, E = Cu.; B, D, F = Con. |
| 18-68 | 18-11 | 5 | 5 | | None | A, D = Al.; B, C = Ch.; E = Cu. |
| 18-69 | 18-1 | 10 | | 10 | None | A = Al.; B = Ch.; Balance = Cu. |
| 18-70 | 18-11 | 5 | 5 | | None | A = Ir.; B = Con.; C = Ch.; D = Al.; E = Cu. |
| 18-71 | 18-15 | 4 | 4 | | None | A = Con.; Balance = Cu. |
| 18-72 | 18-15 | 4 | 4 | | None | D = Con.; Balance = Cu. |
| 18-73 | 18-9 | 7 | 2 | 5 | None | A = Al.; D = Ch.; Balance = Cu. |
| 18-74 | 18-12 | 6 | | 6 | None | A = Ch.; B = Al.; D = Ir.; E = Cu.; C, F = Con. |
| | | | | | | |
| 20-52 | 20-4 | 4 | 4 | | 315° | A = Ir.; B = Con.; C = Ch.; D = Al. |
| 20-56 | 20-7 | 8 | | 8 | 45° | A, B, G, H = Ir.; C, D, E, F = Con. |
| 20-60 | 20-7 | 8 | | 8 | 45° | D = Ch.; E = Al.; Balance = Cu. |
| 20-61 | 20-29 | 17 | | 17 | 45° | A, B, M = Cu.; Balance = Con. |
| 20-62 | 20-15 | 7 | 7 | | 80° | A, C, E = Al.; B, D, F = Ch.; G = Cu. |
| 20-64 | 20-27 | 14 | | 14 | None | A = Al.; C = Ch.; Balance = Cu. |

Thermocouple contact arrangements

| Shell Size and Arrg. | Similar to MS Arrg. | Total Contacts | Contact Size | | Pin Insert Rotation C W | Contact Material |
|----------------------|---------------------|----------------|--------------|----|-------------------------|---|
| | | | 12 | 16 | | |
| 20-65 | 20-27 | 14 | | 14 | None | A, B, C, D, E, F, G = Ir.; H, I, J, K, L, M, N = Con. |
| 20-67 | 20-16 | 9 | 2 | 7 | None | H = Al.; I = Ch.; Balance = Cu. |
| 20-68 | 20-7 | 8 | | 8 | None | A, B, G, H = Con.; C, D, E, F = Cu. |
| 20-69 | 20-27 | 14 | | 14 | None | A, B, C, D, E, F, G = Cu.; H, I, J, K, L, M, N = Con. |
| 20-70 | 20-29 | 17 | | 17 | None | A, C, E, G, J, L, N, R, T = Ir.; B, D, F, H, K, M, P, S = Con. |
| 20-71 | 20-29 | 17 | | 17 | None | S = Al.; R = Ch.; Balance = Cu. |
| 20-74 | 20-29 | 17 | | 17 | None | A, C, E, G, J, L, N, R = Ir.; B, D, F, H, K, M, P, S = Con.; T = Cu. |
| 20-75 | 20-15 | 7 | 7 | | None | G = Al.; Balance = Ch. |
| 20-77 | 20-16 | 9 | 2 | 7 | None | A = Con.; Balance = Std. |
| 20-80 | 20-27 | 14 | | 14 | None | A, C, E, G, I, K, M = Cu.; B, D, F, H, J, L, N = Con. |
| 20-81 | 20-27 | 14 | | 14 | None | A, C, E, G, I, K, M = Ch.; B, D, F, H, J, L, N = Al. |
| 20-82 | 20-29 | 17 | | 17 | None | A, C, E, G, J, L, N, R = Al.; B, D, F, H, K, M, P, S = Ch.; T = Cu. |
| | | | | | | |
| 22-36 | 22-23 | 8 | 8 | | 347° | A, C, E, G = Ir.; B, D, F, H = Con. |
| 22-57 | 22-14 | 19 | | 19 | 45° | A, C, E, G, J, L, N, R = Ir.; B, D, F, H, K, M, P, S = Con.; T, U, V = Cu. |
| 22-60 | 22-14 | 19 | | 19 | 45° | U = Al.; N = Ch.; Balance = Cu. |
| 22-62 | 22-23 | 8 | 8 | | 60° | A, B, F, G = Al.; C, D, E, H = Ch. |
| 22-68 | 22-19 | 14 | | 14 | 45° | A, C, E, G, J, L, M = Ir.; B, D, F, H, K, P, N = Con. |
| 22-69 | 22-19 | 14 | | 14 | 45° | A, C, E, G, J, L, M = Cu.; B, D, F, H, K, P, N = Con. |
| 22-71 | 22-14 | 19 | | 19 | None | V = Al.; U = Ch.; Balance = Cu. |
| 22-72 | 22-5 | 6 | 2 | 4 | None | B = Al.; E = Ch.; Balance = Cu. |
| 22-73 | 22-5 | 6 | 2 | 4 | None | E = Al.; B = Ch.; Balance = Cu. |
| 22-74 | 22-23 | 8 | 8 | | None | A, C, E, G = Ir.; B, D, F, H = Con. |
| 22-75 | 22-23 | 8 | 8 | | None | A = Al.; B, D, G, H = Cu.; C = Ch.; E = Ir.; F = Con. |
| 22-76 | | 21 | | 21 | None | W = Con.; Balance = Cu. |
| 22-77 | 22-19 | 14 | | 14 | None | B, D, F, H, J, K, M, P = Cu.; A, E, L = Ir.; C, G, N = Con. |
| 22-78 | 22-14 | 19 | | 19 | None | A, C, E, G, H, K, M, P, R, T = Con.; Balance = Cu. |
| 22-79 | 22-10 | 4 | | 4 | None | A, C, = Con.; B, D = Cu. |
| | | | | | | |
| 24-56 | 24-20 | 11 | 2 | 9 | 45° | E = Al.; F = Ch.; Balance = Cu. |
| 24-57 | 24-28 | 24 | | 24 | 45° | A, C, J, V, Y, W, K, E, H, U, S, M = Ch.; Balance = Al. |
| 24-62 | 24-28 | 24 | | 24 | None | A, C, E, G = Ir.; B, D, F, H = Con.; R, T = Ch.; S, U = Al.; Balance = Cu. |
| 24-63 | 24-28 | 24 | | 24 | None | A, C, E, G, J, L, K, N, S, U, W, Y = Cu.; B, D, F, H, Q, R, M, P, T, V, X, Z = Con. |
| 24-64 | 24-5 | 16 | | 16 | None | A, B, C, D, E, F, G, H = Ir.; J, K, L, M, N, P, R, S = Con. |
| 24-68 | 24-28 | 24 | | 24 | None | D = Con.; Balance = Cu. |
| 24-81 | 24-7 | 16 | 2 | 14 | None | A, C, E, G, I, K, M, N, P = Cu.; B, D, F, H, J, L, O = Con. |
| | | | | | | |
| 28-53 | 28-11 | 22 | 4 | 18 | 45° | J, L = Al.; K, M = Ch.; Balance = Cu. |
| 28-58 | 28-20 | 14 | 10 | 4 | 45° | A, C, E, G, K, M = Al.; B, D, F, H, L, N = Ch.; J, P = Cu. |
| 28-61 | 28-21 | 37 | | 37 | 45° | A, C, J, Z, m, r, n, a, K, F, H, X, k, h, T, M, N, d = Ir.; Balance = Con. |
| 28-63 | 28-20 | 14 | 10 | 4 | 45° | A, C, E, G, J = Al.; B, D, F, H, P = Ch.; Balance = Cu. |
| 28-64 | 28-15 | 35 | | 35 | None | A, d = Al.; B, j = Ch.; C, D, E, F, G, N, P, R, S, H, J, K, L, M, W, X, Y, Z = Con.; Balance = Cu. |
| 28-65 | 28-12 | 26 | | 26 | None | A, C, E, G, J, L, N, R, T, V = Ir.; X, Z = Al.; B, D, F, H, K, M, P, S, U, W = Con.; Y, a = Ch.; b, d = Cu. |
| 28-67 | 28-16 | 20 | | 20 | None | U = Con.; Balance = Cu. |
| 28-68 | 28-15 | 35 | | 35 | 45° | T = Al.; U = Ch.; Balance = Cu. |

