



1.0 dB LSB GaAs MMIC 5-BIT DIGITAL ATTENUATOR, 0.1 - 33 GHz

Typical Applications

The HMC939LP4 / HMC939LP4E is ideal for:

- Fiber Optics & Broadband Telecom
- Microwave Radio & VSAT
- Military Radios, Radar & ECM
- Space Applications
- Sensors
- Test & Measurement Equipment

Features

- 1.0 dB LSB Steps to 31 dB
- Single Positive Control Line Per Bit
- ±1.0 dB Typical Bit Error
- High Input IP3: +43 dBm
- 16mm² Leadless SMT Plastic Package

Functional Diagram

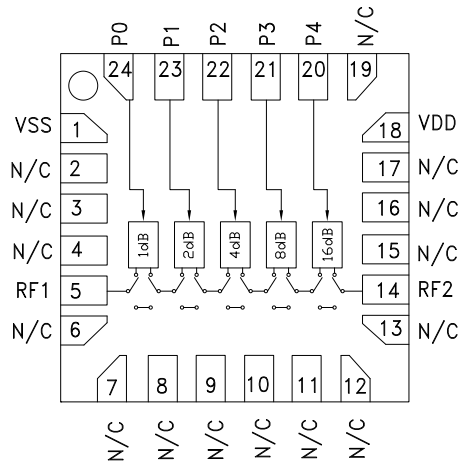

General Description

The HMC939LP4 & HMC939LP4E are broadband 5-bit GaAs IC digital attenuators in low cost leadless surface mount packages. Covering 0.1 to 33.0 GHz, the insertion loss is less than 5 dB typical. The attenuator bit values are 1.0 (LSB), 2, 4, 8, 16 for a total attenuation of 31 dB. Attenuation accuracy is excellent at ±0.4 dB typical step error with an IIP3 of +43 dBm. Five control voltage inputs, toggled between +5V and 0V, are used to select each attenuation state.

Electrical Specifications, $T_A = +25^\circ C$, With $V_{dd} = +5V$, $V_{ss} = -5V$, $P_0 - P_4 = 0 / +5V$

| Parameter | Frequency (GHz) | Min. | Typ. | Max. | Units |
|--|--------------------|---------------------------------|------------------------------------|------|-------|
| Insertion Loss | 0.1 - 18.0 GHz | | 4.0 | 5.5 | dB |
| | 18.0 - 26.5 GHz | | 5.5 | 7.0 | dB |
| | 26.5 - 33.0 GHz | | 6.5 | 8.5 | dB |
| Attenuation Range | 0.1 - 33.0 GHz | | 31 | | dB |
| Return Loss (RF1 & RF2, All Atten. States) | 0.1 - 33.0 GHz | | 12 | | dB |
| Attenuation Accuracy: (Referenced to Insertion Loss) | 1.0 - 15 dB States | 0.1 - 33.0 GHz | ± (0.5 + 5%) of Atten. Setting Max | | dB |
| | 16 - 31 dB States | 0.1 - 20.0 GHz | ± (0.5 + 5%) of Atten. Setting Max | | dB |
| | 16 - 31 dB States | 20.0 - 33.0 GHz | ± (0.6 + 8%) of Atten. Setting Max | | dB |
| Input Power for 0.1 dB Compression | 0.1 - 0.5 GHz | | 20 | | dBm |
| | 0.5 - 33.0 GHz | | 25 | | dBm |
| Input Third Order Intercept Point (Two-Tone Input Power= 0 dBm Each Tone) | 0.1 - 0.5 GHz | | 40 | | dBm |
| | 0.5 - 33.0 GHz | | 43 | | dBm |
| Switching Characteristics | 0.1 - 33.0 GHz | tRISE, tFALL (10/90% RF) | 60 | | ns |
| | | tON/tOFF (50% CTL to 10/90% RF) | 90 | | ns |
| I _{dd} | 0.1 - 33.0 GHz | 2.5 | 4.5 | 6.5 | mA |
| I _{ss} | 0.1 - 33.0 GHz | -7.0 | -5.0 | -3.0 | mA |

Information furnished by Analog Devices is believed to be accurate and reliable. However, no responsibility is assumed by Analog Devices for its use, nor for any infringements of patents or other rights of third parties that may result from its use. Specifications subject to change without notice. No license is granted by implication or otherwise under any patent or patent rights of Analog Devices. Trademarks and registered trademarks are the property of their respective owners.

For price, delivery, and to place orders: Analog Devices, Inc., One Technology Way, P.O. Box 9106, Norwood, MA 02062-9106
 Phone: 781-329-4700 • Order online at www.analog.com
 Application Support: Phone: 1-800-ANALOG-D

HMC939* PRODUCT PAGE QUICK LINKS

Last Content Update: 02/23/2017

COMPARABLE PARTS

View a parametric search of comparable parts.

EVALUATION KITS

- HMC939LP4E Evaluation Board

DOCUMENTATION

Data Sheet

- HMC939 Die Data Sheet
- HMC939LP4 Data Sheet

TOOLS AND SIMULATIONS

- HMC939 Die S-Parameters
- HMC939LP4 S-Parameters

REFERENCE MATERIALS

Quality Documentation

- Semiconductor Qualification Test Report: PHEMT-D (QTR: 2013-00254)

DESIGN RESOURCES

- HMC939 Material Declaration
- PCN-PDN Information
- Quality And Reliability
- Symbols and Footprints

DISCUSSIONS

View all HMC939 EngineerZone Discussions.

SAMPLE AND BUY

Visit the product page to see pricing options.

TECHNICAL SUPPORT

Submit a technical question or find your regional support number.

DOCUMENT FEEDBACK

Submit feedback for this data sheet.



1.0 dB LSB GaAs MMIC 5-BIT DIGITAL ATTENUATOR, 0.1 - 33 GHz

Insertion Loss vs. Temperature

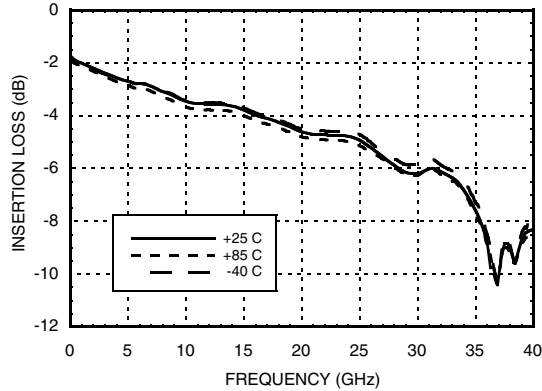

Normalized Attenuation
(Only Major States are Shown)

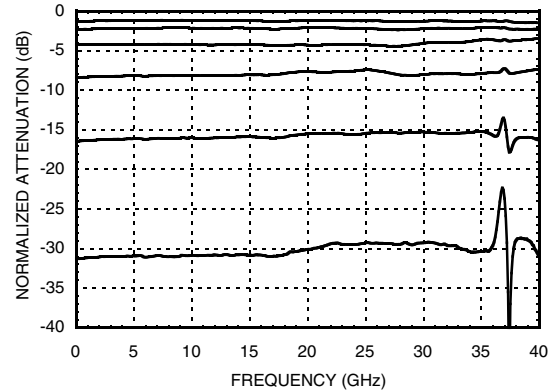

Input Return Loss
(Only Major States are Shown)

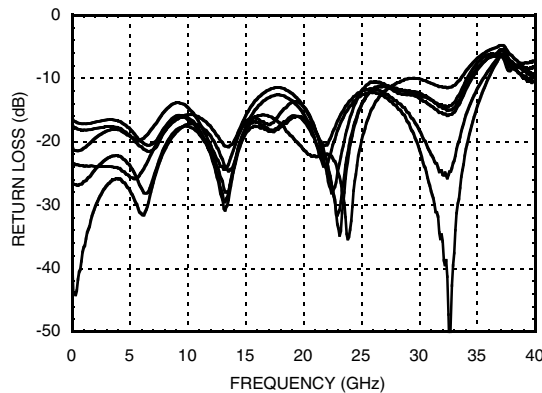

Output Return Loss
(Only Major States are Shown)

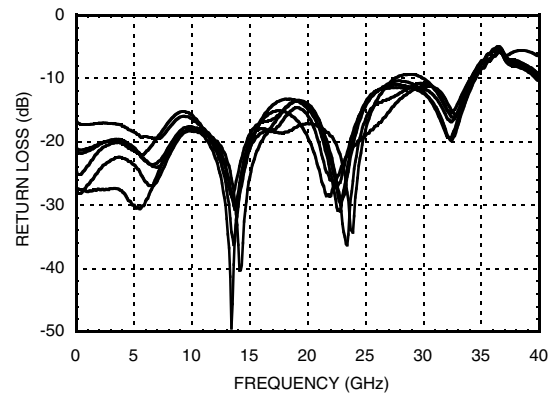

Bit Error vs. Attenuation State

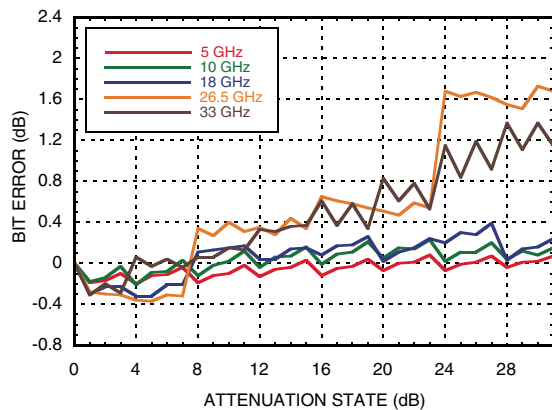

Bit Error vs. Frequency
(Only Major States are Shown)

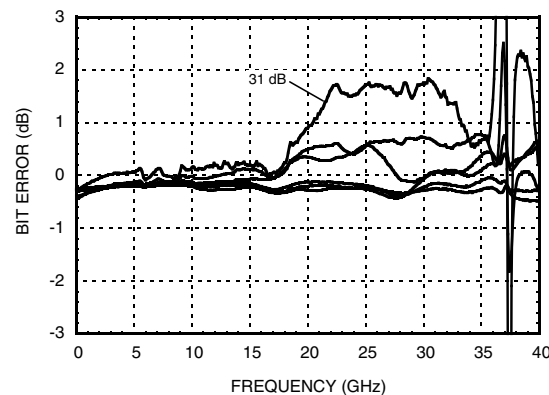



Relative Phase vs. Frequency
(Only Major States are Shown)

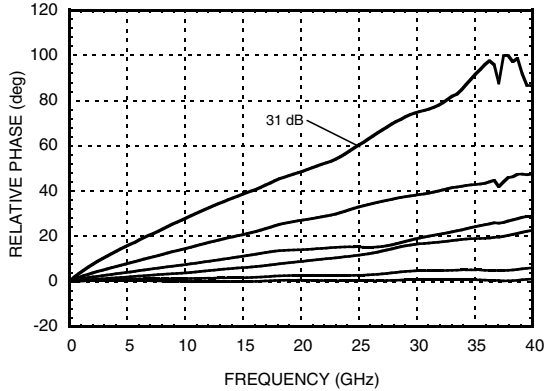

**1.0 dB LSB GaAs MMIC 5-BIT DIGITAL
ATTENUATOR, 0.1 - 33 GHz**

Step Attenuation vs. Attenuation State
0.1 - 18 GHz

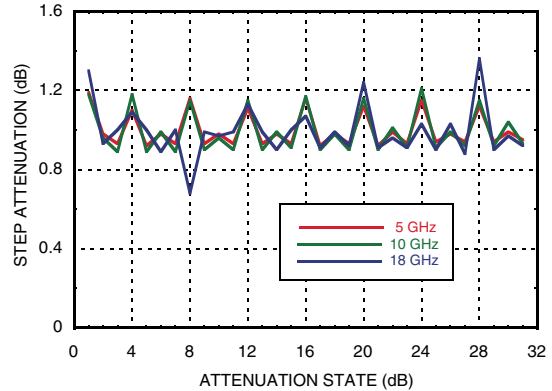

Step Attenuation vs. Attenuation State
18 - 33 GHz

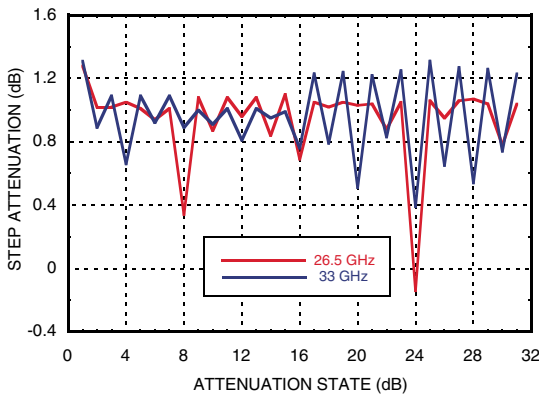

Input Power for 0.1 dB Compression

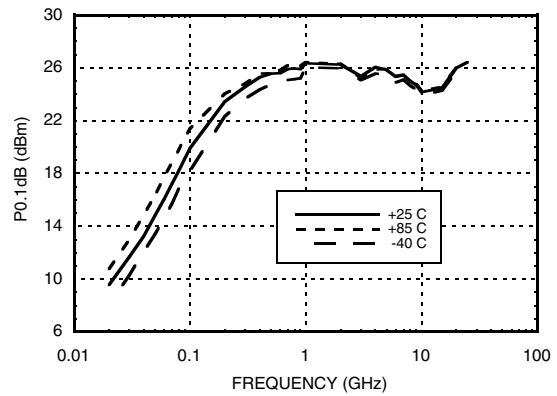

Input IP3 Over Major Attenuation States

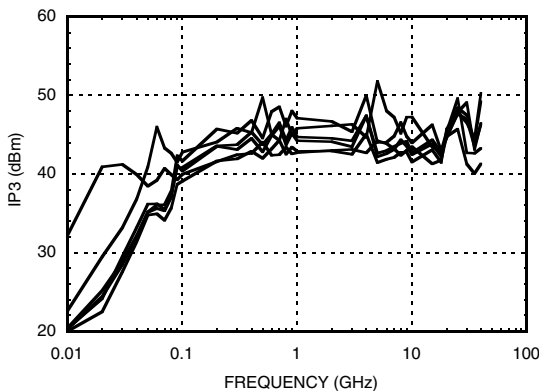

Input IP3 vs. Temperature

(Minimum Attenuation State)

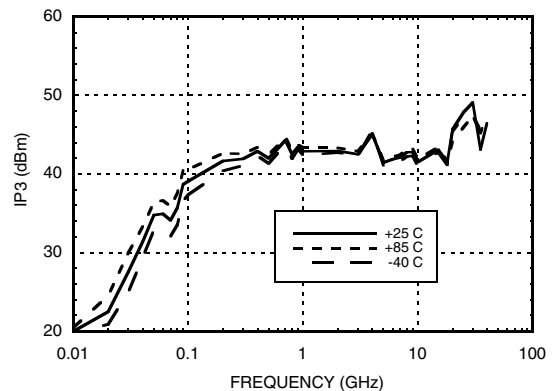

Information furnished by Analog Devices is believed to be accurate and reliable. However, no responsibility is assumed by Analog Devices for its use, nor for any infringements of patents or other rights of third parties that may result from its use. Specifications subject to change without notice. No license is granted by implication or otherwise under any patent or patent rights of Analog Devices. Trademarks and registered trademarks are the property of their respective owners.

For price, delivery, and to place orders: Analog Devices, Inc., One Technology Way, P.O. Box 9106, Norwood, MA 02062-9106 Phone: 781-329-4700 • Order online at www.analog.com Application Support: Phone: 1-800-ANALOG-D



1.0 dB LSB GaAs MMIC 5-BIT DIGITAL ATTENUATOR, 0.1 - 33 GHz

Absolute Maximum Ratings

| | |
|--|-----------------|
| RF Input Power (0.1 to 33.0 GHz) | +25 dBm |
| Control Voltage (P0 to P4) | Vdd + 0.5V |
| Vdd | +7 Vdc |
| Vss | -7 Vdc |
| Channel Temperature | 150 °C |
| Continuous Pdiss (T = 85 °C) (derate 6.8 mW/°C above 85 °C) | 0.451 W |
| Thermal Resistance | 144 °C/W |
| Storage Temperature | -65 to + 150 °C |
| Operating Temperature | -40 to +85 °C |
| ESD Sensitivity (HBM) | Class 1A |

Bias Voltages & Currents

| | |
|-----|--------------|
| Vdd | +5V @ 4.5 mA |
| Vss | -5V @ 5 mA |

Control Voltage

| State | Bias Condition |
|-------|------------------|
| Low | 0 to 0.8V @ 1 μA |
| High | 2 to 5V @ 1 μA |



ELECTROSTATIC SENSITIVE DEVICE
OBSERVE HANDLING PRECAUTIONS

Outline Drawing

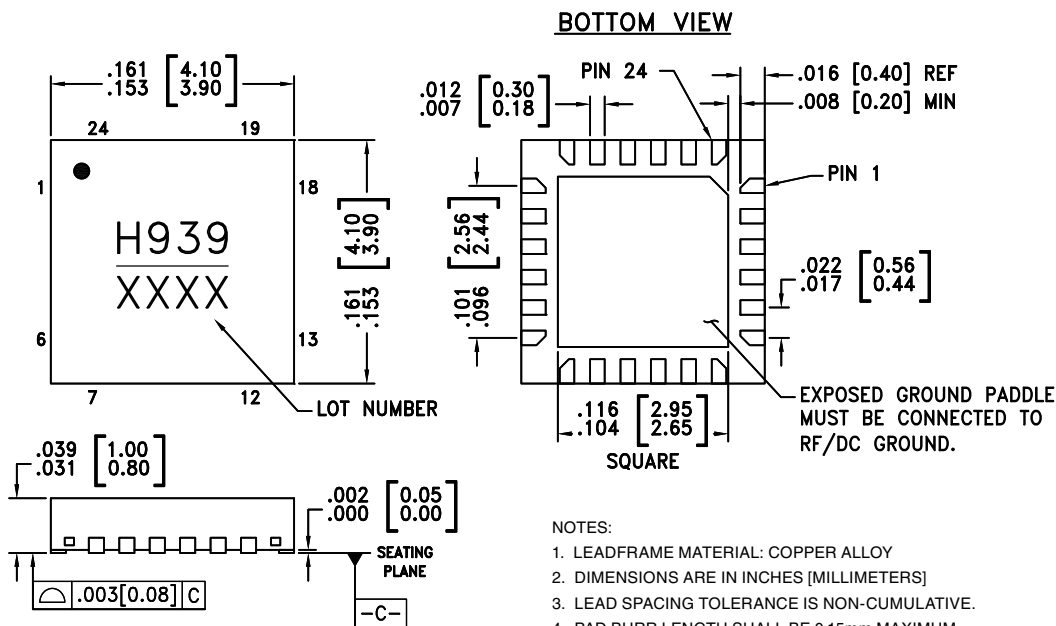

NOTES:

- LEADFRAME MATERIAL: COPPER ALLOY
- DIMENSIONS ARE IN INCHES [MILLIMETERS]
- LEAD SPACING TOLERANCE IS NON-CUMULATIVE.
- PAD BURR LENGTH SHALL BE 0.15mm MAXIMUM.
PAD BURR HEIGHT SHALL BE 0.05mm MAXIMUM.
- PACKAGE WARP SHALL NOT EXCEED 0.05mm.
- ALL GROUND LEADS AND GROUND PADDLE MUST BE SOLDERED TO PCB RF GROUND.
- REFER TO HITTITE APPLICATION NOTE FOR SUGGESTED LAND PATTERN.

Package Information

| Part Number | Package Body Material | Lead Finish | MSL Rating | Package Marking ^[3] |
|-------------|--|---------------|---------------------|--------------------------------|
| HMC939LP4 | Low Stress Injection Molded Plastic | Sn/Pb Solder | MSL1 ^[1] | H939 XXXX |
| HMC939LP4E | RoHS-compliant Low Stress Injection Molded Plastic | 100% matte Sn | MSL1 ^[2] | H939 XXXX |

[1] Max peak reflow temperature of 235 °C

[2] Max peak reflow temperature of 260 °C

[3] 4-Digit lot number XXXX



1.0 dB LSB GaAs MMIC 5-BIT DIGITAL ATTENUATOR, 0.1 - 33 GHz

Truth Table

| Control Voltage Input | | | | | Attenuation State RF1 - RF2 |
|-----------------------|------------|------------|------------|------------|--------------------------------|
| P4 16 dB | P3 8 dB | P2 4 dB | P1 2 dB | P0 1 dB | |
| High | High | High | High | High | Reference I.L. |
| High | High | High | High | Low | 1 dB |
| High | High | High | Low | High | 2 dB |
| High | High | Low | High | High | 4 dB |
| High | Low | High | High | High | 8 dB |
| Low | High | High | High | High | 16 dB |
| Low | Low | Low | Low | Low | 31 dB |

Any Combination of the above states will provide an attenuation approximately equal to the sum of the bits selected.

Pin Descriptions

| Pad Number | Function | Description | Interface Schematic |
|----------------------|----------|--|---------------------|
| 1 | Vss | Negative Bias -5V | |
| 2-4, 6-13, 15-17, 19 | N/C | The pins are not connected internally; however, all data shown herein was measured with these pins connected to RF/DC ground externally. | |
| 5, 14 | RF1, RF2 | These pins are DC coupled and matched to 50 Ohm. Blocking capacitors are required if RF line potential is not equal to 0V. | |
| 18 | Vdd | Positive Bias +5V | |
| 20 - 24 | P0 - P4 | See truth table and control voltage table. | |
| | GND | Package bottom must be connected to RF/DC ground. | |



**1.0 dB LSB GaAs MMIC 5-BIT DIGITAL
ATTENUATOR, 0.1 - 33 GHz**

Application Circuit

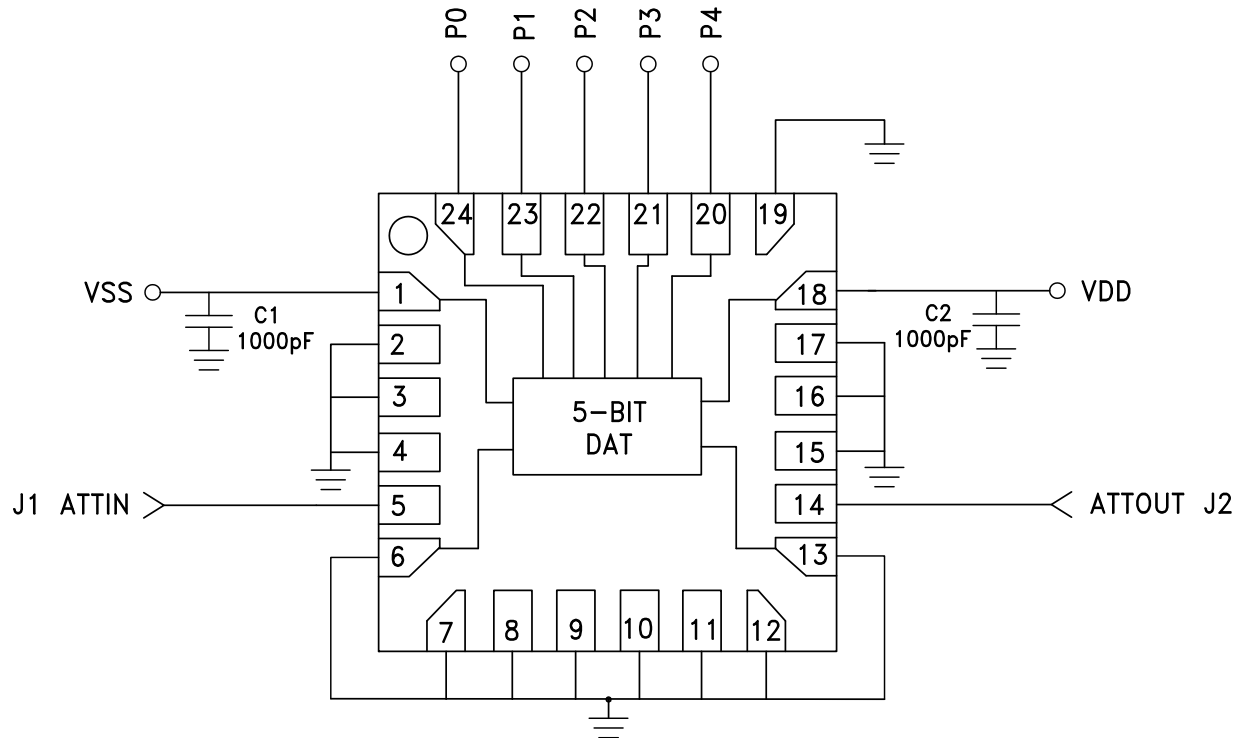

1.0 dB LSB GaAs MMIC 5-BIT DIGITAL ATTENUATOR, 0.1 - 33 GHz



Evaluation PCB

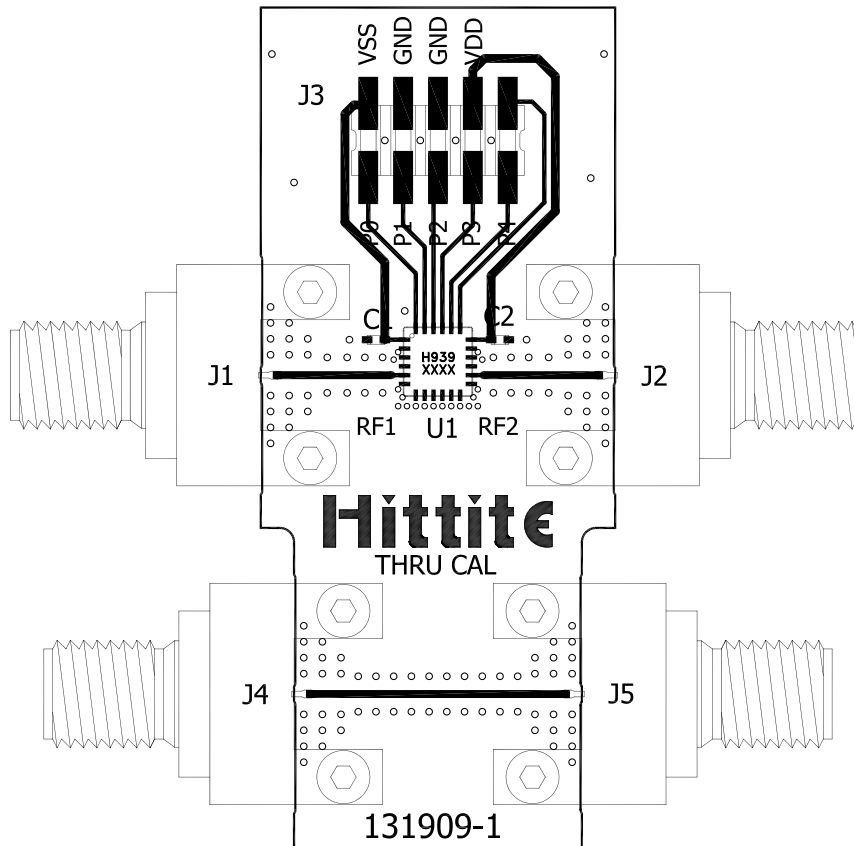

List of Materials for Evaluation PCB 130450 [1]

| Item | Description |
|----------------|------------------------------|
| J1, J2, J4, J5 | 2.9 mm PC Mount RF Connector |
| J3 | DC Connector |
| C1, C2 | 1000 pF Capacitor, 0402 Pkg. |
| U1 | HMC939LP4 Digital Attenuator |
| PCB [2] | 131909 Evaluation Board |

[1] Reference this number when ordering complete evaluation PCB

[2] Circuit Board Material: Rogers 4350

The circuit board used in the application should use RF circuit design techniques. Signal lines should have 50 Ohm impedance while the package ground leads should be connected directly to the ground plane similar to that shown. A sufficient number of via holes should be used to connect the top and bottom ground planes. The evaluation circuit board shown is available from Hittite upon request.

**Notes:**

v01.1211

HMC939LP4 / 939LP4E**1.0 dB LSB GaAs MMIC 5-BIT DIGITAL
ATTENUATOR, 0.1 - 33 GHz**