

STOCK AND CUSTOM SOLUTIONS FOR ENHANCING YOUR PRODUCT'S VALUE

**ECO-FRIENDLY
PRODUCTS**



**COMPARTMENTED
BOXES**



OVERVIEW

Single Source Solutions... In Plastic

Flambeau, Inc. is a worldwide industry leader in thermoplastic manufacturing, specializing in both injection and blow molding. Flambeau possesses the largest array of proprietary stock products and storage containers for both Consumer and Original Equipment markets. Our unique competitive advantage is the ability to offer customized stock solutions through value-add manufacturing. Our range of service includes offering custom colors; labels; special decorating; engraved logo plates; finishing; special processing; small production run quantities; and comprehensive assistance with design and customization requirements.

Flambeau is your “**art to part**” source for your plastic packaging requirements. Should your application require a solution that does not exist within our stock offering, our program management team is available to offer our **full range of services**. These services include part design; prototyping; mold design and fabrication; manufacturing and assembly; sampling; custom quoting; and product fulfillment programs.

NEW Flambeau is continuously adding timely new products and programs to our Packaging offering. We are pleased to announce “**NEW**” in this catalog:

- Medical Device storage box (pg. 62) for heart pace makers and miniature implantable devices.
- Large 9" Black Ribbon case (pg. 45) great for protecting sensitive electronics and hand held devices.
- Infinity FV 6.5 Blow Mold Express Service case (pg. 39) extends the Infinity product line for “off the shelf” cases.
- Merchant 15 Series cases (pg. 36) the largest cases in Merchant category with open core or partitioned storage features.
- Rolling Tote Storage Cabinet (pg. 55) great for light commercial MRO product storage and transportation.
- Gun Cases (pg. 53) provides wide range of choices for rifle and small fire arm storage and transportation.

Choose Flambeau ZERUST to enhance case performance against rust and tarnish when storing and protecting your valuables in these great new products from Flambeau!

 Flambeau is also pleased to make nearly all our manufactured polyolefin based products **biodegradable!** (Minimum quantities may apply). Several popular Flambeau boxes and cases are now manufactured and stocked this way (see our Frog friendly  icon) where applicable!

We encourage you to examine all we can offer at:



www.flambeaucases.com

-or-



www.flambeau.com

Profile & History

Flambeau Packaging & Storage Solutions is a division of Flambeau, Inc., a member of the Nordic Group of Companies. Founded in 1947, today the Nordic Group has sales in excess of \$350 million and operates with more than 2,000 associates worldwide. Headquartered in Baraboo, Wisconsin, Flambeau has manufacturing facilities throughout the United States with additional locations in England and Mexico. Flambeau continues to foster core values such as **Family, Integrity, Leadership, Teamwork, and Knowledge** to pursue **Excellence** with people who care and are committed to anticipate the professional service that you need, when you need it!

Quality: TS/ISO Accreditation

There is a difference! By adhering to the strictest quality standards in all aspects of our business, Flambeau exceeds your quality expectations through a commitment of ongoing and continuous quality improvements and proactive cost reductions.

Customer Service

Our professional Customer Service associates are eager to help answer questions and solve problems! We are committed to help provide solutions whether it's an ordinary question or a technical challenge. Please contact us toll-free at **800-344-5716**.



Flambeau Manufacturing Locations

UNITED STATES

- Baraboo, WI
- Columbus, IN
- Middlefield, OH
- Madison, GA
- Redlands, CA
- Weldon, NC

INTERNATIONAL

- Ramsgate, Kent, England
- Saltillo, Coahuila, Mexico



ENVIRONMENTALLY FRIENDLY FROM FLAMBEAU®

Biodegradable Products

Flambeau's Packaging Division NOW OFFERS:



Completely 100 % Biodegradable & 100 % Recyclable Storage Cases and Boxes



Biodegradation occurs with our uniquely manufactured products in either an aerobic and or anaerobic environment:

- In Landfills
- In Compost (backyards as well as commercial facilities) or
- Buried in the ground

Flambeau's biodegradable manufacturing process does not produce any toxic residues. Once our products return to the environment in compost or landfill hosts then, nothing but a safe biomass and humus results.

- Aerobic—Biomass, CO2, Water
- Anaerobic—Biomass, Methane, CO2, some Water

Moreover, the physical characteristics of Flambeau's "eco-friendly" packaging are equal to those of our traditional packaging---which emphasizes Flambeau's commitment to manufacture high quality, durable, plastic packaging. Products manufactured by Flambeau utilizing our "eco-friendly" process and materials do not affect our merchandise guarantee!

We offer: Completely 100 % Biodegradable & 100 % Recyclable. Ensures customers disposal of product lessens their carbon footprint on the environment & provides additional value to items sold.

No degradation by exposure to external stresses during storage, shipping, handling, or normal use. Provides an indefinite shelf life and similar service life as our standard resins.

Technical & Physical properties of cases and boxes made with Flambeau eco-friendly materials are equivalent to our traditional packaging---maintaining Flambeau's commitment to manufacturing high quality products.

Flambeau's capability with biodegradable packaging extends across the entire polyolefin product line, and can be manufactured and made available in most products with production quantities as small as 1,000 units.

Flambeau currently stocks a number of popular Flambeau boxes incorporating our "eco" friendly materials. Look for the "bio frog" icon!

Contact customer service to see if your packaging can be biodegradable!



Can be made



Can be made

Be sure to contact Flambeau Customer Service at 1-800-344-5716 for assistance with ordering your boxes and cases with this timely new offering from Flambeau!

SOFT-SIDES: FLAMBEAU®

Flambeau... a world leader in manufacturing Plastic Cases and Boxes **INTRODUCES...**
SOFT-SIDE BAGS AND CASES!



Your name/company here

NEW OFFERING!

Flambeau is pleased to offer an extensive range of canvas bags and cases for your customization! Countless options with canvas bags and cases are at your fingertips!

Your products can now be stored, protected, or merchandised with unlimited canvas choices!



MANY CHOICES!

Choose sewn products with hard cases! Choose any combination of Flambeau rigid boxes and cases from our vast stock product line to use in combination with your canvas choice!



TURN-KEY SERVICE...

Your company brand / logo is critical to your marketing success. Flambeau can help you design the right solution for your products.

- Your company identity
- Your color scheme
- Your products uniquely packaged
- Your custom solution

CONTACT US TODAY!

Contact Flambeau today

Phone: **1-800-344-5716** or **1-440-632-1631**

or see your factory salesman for more details!



Great for protecting and transporting instruments, equipment, tools, small electronic devices, medical equipment, sports products, and much, much more!

SPECIAL PROGRAMS & OFFERINGS

EXPRESS SERVICE *What You Need, When You Need It.*

Flambeau's **Express ServiceSM** program is our way of providing the industry's largest selection of in-stock, ready-to-ship cases and boxes which ship within 24 business hours of your order. With minimum order quantities from one unit to single case quantities, this program truly gives you the flexibility and convenience to order exactly "What You Need, When You Need It."

Qualifying products are marked throughout the catalog with this symbol "E".



Low volume custom boxes are now available through Flambeau's **Blue Diamond ProgramSM**! Select in-stock injection molded boxes are available for custom decorating with a hot stamp. Company names and logos have never been easier!

Qualifying products are available in case quantities and marked throughout the catalog with a "D" symbol.



*See "Customized Stock and Custom Options" Section: "Hot Stamp Labeling" **page 9**, and for an example of available hot stamp colors see **page 8**.

"Special Order" / Non-Stock Products

Our goal is to offer you the most comprehensive selection of products possible. Although most products are in-stock and ready to ship, we offer a wide variety of products that are not stocked.

Non-stock products are marked in the catalog as "S" and are available with reasonable lead-times. Please inquire with a Customer Service associate at 800-344-5716 for additional product and production details.

For your convenience & order processing speed we accept:



CAPABILITIES

Stock Products – “Off Our Shelf to Yours”

With over 300 *in-stock* product choices, Flambeau has the most extensive selection of injection boxes and heavy-duty blow molded cases for applications in every industry. Most products are in-stock and ready-to-ship. **Express Service™** and **Blue Diamond** programs (see overview section) make it easy to order with no minimums and/or low quantities with custom printing. Any non-stock items are marked “**Ⓢ**” and are available through scheduled production. Although all of our cases are available without foam, many blow molded cases are available with foam. We use two-pound polyurethane convoluted foam in the lid and flat foam in the base (as shown). When the case is closed, lid and base foam touch to hold parts securely.

Stock Blow Molded Case Options



Customized Stock Products – “Personalized”

Because we understand the importance of *customization*, our stock proprietary products are designed to easily adapt to your needs. For your convenience, we take our stock products “*off-the-shelf*” and add customization of your choice. *See “*Customized Stock and Custom Options*” section starting on **page 9**.

Contract Manufacturing – “Art-To-Part” Customization

Beyond our proprietary products, Flambeau offers total program management from “art-to-part”. With a reputation of providing *single-source solutions* we are prepared for your most challenging project. We utilize our in-house engineering and design services, prototyping, tool fabrication, unique product production techniques, and post mold operations, such as custom assembly, so your specific needs can be met. You can be sure that Flambeau will provide personal service as our dedicated cross-functional associate team works the details. We make your vision a reality. *See “*Customized Stock and Custom Options*” section.

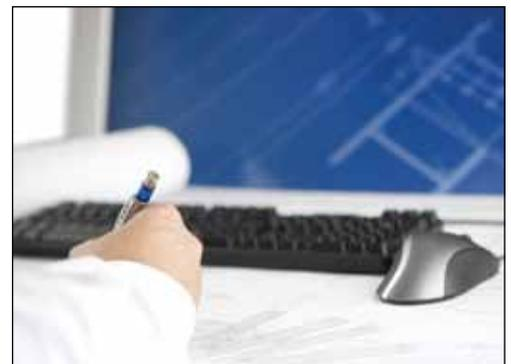

****Most products can be produced with custom resins and colors upon request. Please contact a Customer Service associate at 800-344-5716 for details.***

ZERUST® & TARNISH INHIBITOR CAPABILITIES

FLAMBEAU® ZERUST® PRODUCTS STOP RUST



by releasing an invisible, odorless, non-toxic, non-flammable, and non-reactive proprietary corrosion inhibiting vapor that protects metal components from corrosion for up to five years. Flambeau Zerust corrosion inhibitor is molded directly into plastic. Inside a relatively well-sealed package made from Flambeau Zerust materials, or within an enclosure containing them, this vapor will settle on all exposed metal surfaces, forming a very thin protective layer (only a few molecules thick). This molecular layer inhibits the electrochemical reactions at the surface of the metal that cause corrosion.

Flambeau Zerust products do not affect the electrical or mechanical properties or functionality of the metal components that they protect. In fact, they actually help improve reliability by preventing corrosion damage too small to be seen by the naked eye. **See page 34 for ordering information.**

THE 24 HOUR TEST



Test performed with distilled water & Flambeau® Zerust® Capsule submerged 48 hours prior to adding metal.

THE 1 MONTH TEST



Tarnish Inhibitor by Flambeau provides safe, long-term protective storage for sterling silver items. The patented Tarnish Inhibitor additive forms a harmless protective layer around silver surfaces preventing tarnishing for up to five years.

Flambeau stocks select Super Satchels™ and Tuff Tainers® with Tarnish Inhibitor or Zerust molded within the product. Most products incorporating the Tarnish Inhibitor or Zerust features are available through our **Special Order Program** and may require certain minimum quantities.

See page 34 for ordering information for Tarnish Inhibitor and Zerust Divider Packs. These divider packs provide the same great protection molded in the “divider” for use in Flambeau Super Satchels and Tuff Tainers.

CUSTOM COLORS, OPTIONS & CUSTOMIZABLE STOCK

Stock*/Custom Blended Colors** Flambeau keeps a comprehensive selection of color resins “in-house” and ready for production.
**Colors must meet minimum order requirements **Custom blended colors available upon request*

Available Injection Molded Colors:

 Taupe PMS 409C	 Black PMS 6C	 Gray PMS 432C	 Yellow PMS 109C	 Blue PMS 289C
 Orange PMS 1665C	 Evergreen PMS 553C	 Red PMS 1805C	 Translucent Blue PMS 307C	 Translucent Red PMS 198C
 Translucent Yellow PMS 3955C	 Translucent PMS N/A	 White PMS 77C	 Olive Green PMS 418C	 Translucent Green PMS 354C

Available Blow Molded Colors:

 Orange PMS 158C	 White PMS 77C	 Black PMS 6C
 Gray PMS 433C	 Silver PMS 877C	 Blue PMS 307C
 Red PMS 187C	 Yellow PMS 116C	 Evergreen PMS 553C

Available Hot Stamp Foil Colors:

 Black PMS 6C	 White PMS 77C	 Blue PMS 286C
 Yellow Crown Roll PMS 114C	 Green PMS 3308C	 Platinum PMS 877C
 Red PMS 186C	 Gold PMS 871C	

Color Options

Many stocked and custom colors are available. Please contact a Customer Service associate at 800-344-5716 for details.

See stocked colors on above.



In-mold Decorating

** Injection or blow molded products*

A revolutionary new and popular process that is quickly replacing the application of labels and other decorating processes, in-mold decorating provides an incredible opportunity to decorate large or multiple areas with confidence of quality. This process allows us to apply a graphic label(s) robotically while in production. The result – better product presentation with guaranteed straight, crisp, clear graphics that are impervious to most chemicals, peeling, bubbling, cracking or falling off all together.



CUSTOMIZED STOCK & CUSTOM OPTIONS

Engraving

** Injection or blow molded products*

We use lid and base inserts on our stock and proprietary products. This allows you the flexibility to insert a custom engraved company logo and/or design plate on one or both sides of your case.



Hot Stamp Labeling

** Injection molded products only*

Hot stamping is a very common and economical way of getting your product customized. Stamping typically is done in a single color but can be as many as three colors. Best results are on a smooth surface.

See *Blue Diamond ProgramSM* on **page 5** for details.



Labels

** Injection or blow molded products*

Although quickly being replaced by in-mold labeling, adhesive-backed labels can be added to most products in a post-mold secondary application. Should you choose this method over another method of decorating, we can offer a number of suggestions to help you in this process. Please contact a Customer Service associate for additional information at 800-344-5716.



Handles, Latches & Accessories

A variety of handles and latches are available for our blow molded cases. For pricing and availability please contact a Customer Service associate at 800-344-5716. For pictures and descriptions see "Options" on **pages 46-47**.

CUSTOMIZED STOCK & CUSTOM OPTIONS

Custom Interiors - "Cores"

** Injection or blow molded products*

Custom "cores" or interiors can be tooled at the Flambeau Technology Center™ for the majority of product Flambeau manufactures. This is an excellent cost-effective alternative to foam or thermoformed inserts for high-volume requirements. Flambeau's design engineering staff will help you determine the best options to meet your objectives.



Custom Foam Interiors

** Injection or blow molded products*

The professional look, moderate cost and flexibility of die-cut foam have made it a popular choice in numerous industries. Contact a Customer Service associate for pricing and lead-time at 800-344-5716.



FREQUENTLY ASKED QUESTIONS

1. What are your order minimums, lead-times & fulfillment times?

Standard lead-times are based on order acceptance/ confirmation and customer approval of any applicable artwork and/or the part type and/or classification.

Program	Ship Time	Minimums
Stock Products	Within 3 Business Days	Full Carton Quantities
Express Service	Within 24 Business Hours	Single Unit- Blow Mold Products; Full Case Quantity - Injection Molded Products
Blue Diamond Program SM	Up to 4 Weeks	Case Quantity
Special Order/Non-Stock	Up to 6 Weeks	Call
Custom	Call	Call

2. What size area and location on your boxes can be used for printing?

Each area is slightly different based on the product you have selected. Please contact one of our Customer Service associates for details at 800-344-5716.

3. What file formats do you accept for artwork for hot stamps, in-mold decorating or printing?

Programs: Illustrator (preferred), Freehand, Photoshop **File Formats:** AI (preferred), EPS, TIFF, or JPEG **Quality:** 300 dpi at 100% size

4. Can you hot stamp a blow molded case?

No, you can only hot stamp an injection molded box. There are three (3) choices for customizing a blow molded case. Engraving a plate, in-mold decorating (labeling) or standard adhesive labels are the best choices for decorating. These choices typically require a minimum order of 500 pieces and have additional charges associated with set up and/or tooling. Please contact a Customer Service associate for more details & a quote specific to your project at 800-344-5716.

5. How do I know whether to use a blow molded or injection molded product?

If a custom interior for presentation and protection is most important, then a blow molded, double-wall case such as the Infinity™ would be the best choice. If compartmentalization and visualization for Point of Purchase is required, one of our injection molded cases or boxes would be a good choice.

6. What modifications can I make to a stock case?

Modifications include interior custom cores, handles, latches, case color and even material. A detailed request for quote (RFQ) should be filled out by our sales staff. Flambeau associates are trained to help you make economical and functional decisions about the right case for your application and product.

7. How do I decide what type of custom interior to use?

We offer either custom molded interiors or custom foam interiors. Although size, weight, application and type of part are considerations, we typically will recommend you consider custom foam for annual volumes of 750 units or less. Our Flambeau Technology Center™ can fabricate a tool for custom molded interiors and our staff of engineers would be happy to assist you in the design.

8. What material should I use for my compartmented box application?

If clarity is most important, styrene is an excellent choice. If durability is most important, polypropylene is the best choice. If clarity and durability are important, Styrene-Butadiene Methyl Methacrylate is the best choice.

9. How many times can you open and close the integral hinge before it cracks or breaks?

Our integral hinge boxes are manufactured to withstand thousands of openings and, therefore, it is reasonable to expect that under normal use, the hinge will last for the life of the product.

COMPARTMENTED BOXES

A-Series Boxes

Styrene

The original Flambeau styrene box. The A-Series has a distinct stout look with very square corners and true 90° walls. Still a very popular pick with customers from many industries.

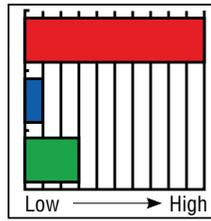

■ Clarity*
■ Impact Resistance
■ Chemical Resistance

Can Be Made



Diamondback™ Boxes

Styrene

With a slight architectural edge radius & rounded corners, this box is crystal clear like glass and is excellent for merchandising and general display of products. This box also has small stacking feet to keep displays neater and features an easy open hinge. US Patent D412,786

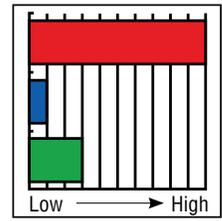

■ Clarity*
■ Impact Resistance
■ Chemical Resistance

Can Be Made



Precision Boxes

Styrene Butadiene Methyl Methacrylate

Molded from styrene butadiene methyl methacrylate, this box features transparent clarity and impact resistance even in the harshest conditions. The Precision excels in wet applications with its rust-proof hinge.

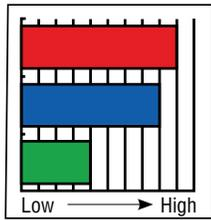

■ Clarity*
■ Impact Resistance
■ Chemical Resistance

Can Be Made



Mighty-Tuff™ Boxes

Cellulose Propionate

Just as the name implies, the Mighty-Tuff is tough! This transparent cellulose propionate material excels in industrial and institutional environments. With a double metal hinge you can be sure that this box will take almost any punishment you can give it.

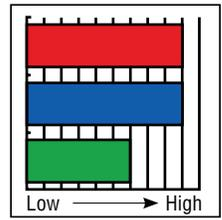

■ Clarity*
■ Impact Resistance
■ Chemical Resistance

Can Be Made



M-Series Boxes

Polypropylene

Extra heavy-duty construction makes the polypropylene M-Series boxes tough and durable. These workhorse boxes feature a heavy-duty, heat-sealed hinge and overlapping lid to inhibit dust. Impervious to most household chemicals, solvents, oil and gasoline, these boxes keep items safe and organized.



Can Be Made

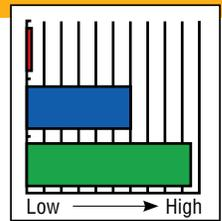

■ Clarity*
■ Impact Resistance
■ Chemical Resistance

COMPARTMENTED BOXES

V-Series Boxes

Polypropylene

With a living hinge (flex hinge) and dual positive snap lock latches these single compartment boxes are excellent for storage of larger items or for the autoclave process.

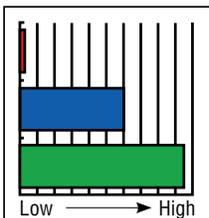

Can Be Made



K-Series Boxes

Styrene Butadiene Copolymer

Noted for heavy-duty applications, this styrene butadiene copolymer box has excellent impact properties and also maintains scratch-resistant and transparent qualities.

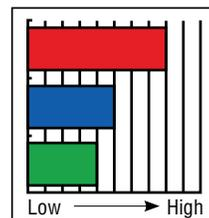

Can Be Made



Tuff Tainer® Boxes

Polypropylene

The Tuff Tainer is made with polypropylene and features a detachable lid and movable dividers that allow you to configure your compartment space to your liking. The majority of these boxes include two positive locking latches and will resist most common chemicals, gasoline & oil.

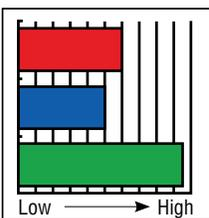

Can Be Made



Mechanical latch found on T4007 & T5007 TuffTainers



Integral latch found on all TuffTainers except T4007 & T5007



IDS™ (Infinite Divider System) Boxes

Polypropylene

Made of polypropylene, this ultimate organizational system gives you the flexibility you have always dreamed of by allowing you to move each divider 1/16 (0.16 cm) of an inch along the ribbed compartment. IDS boxes fit in the IDS Cabinet shown on page 49.

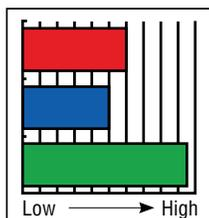

T-Series Boxes

Polypropylene

T-Series boxes provide the same durable construction as the popular M-Series, but are made with translucent polypropylene. These boxes are perfect for "visualizing" components within the box. The T-Series are impervious to most household chemicals, solvents, and gasoline. Great for storage and protection.

Can Be Made

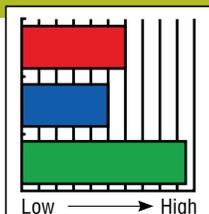

COMPARTMENTED BOXES

With a reputation for selection, Flambeau is now asking the industry to “think outside of the box” with the addition of the Blue Diamond ProgramSM! Now you can add custom printing to select products at low volume order quantities. With the industry’s largest selection of sizes and material types you can expect to find what you need right on our shelf. Finding a compartmented box has never been easier.

Even with over 300 stock choices, sometimes we have a request for a unique size or compartment configuration. If so, please let us know. Most of our products can be altered to accommodate a special material or core (compartment) requirement for your project. Finally, we will accommodate you by building a tool specifically for your project right in our Technology Center.

Compartmented Box Size Reference Chart

To help you find what you need we have added a size reference chart that lists all of Flambeau's compartmented boxes from their smallest to largest dimension.

BOX MATERIAL KEY			SYMBOL KEY
TP = Translucent Polypropylene	YP = Yellow Polypropylene	TCP = Transparent Cellulose Propionate	⬢ = Blue Diamond
SP = Taupe Polypropylene	WP = White Polypropylene	SBC = Styrene-Butadiene Copolymer	Ⓢ = Special Order
OP = Orange Polypropylene		SBMM = Styrene Butadiene Methyl Methacrylate	

Inside L x W x D	Model	Fixed Comps	Material	Page
3-11/16" x 2-9/16" x 13/16" (9.37 x 6.51 x 2.06 cm)	2020-2 ⬢	1	SBMM	20
4" x 3-3/8" x 13/16" (10.16 x 8.57 x 2.06 cm)	2040-2 Ⓢ	1	WP	20
4-1/4" diameter x 3/4" (10.80 diameter x 1.91 cm)	A01 Ⓢ	1	Styrene	20
4-5/16" x 2-5/8" x 1-1/16" (10.95 x 6.67 x 2.70 cm)	5200CL	1	TCP	20
4-5/16" x 2-5/8" x 1-1/16" (10.95 x 6.67 x 2.70 cm)	5202CL	2	TCP	20
4-5/16" x 2-5/8" x 1-1/16" (10.95 x 6.67 x 2.70 cm)	5204CL	4	TCP	20
4-5/16" x 2-5/8" x 1-1/16" (10.95 x 6.67 x 2.70 cm)	5206CL Ⓢ	6	TCP	20
4-5/16" x 2-5/8" x 1-1/8" (10.95 x 6.67 x 2.86 cm)	T1002 ⬢	4	TP	20
4-3/8" x 2-5/8" x 1" (11.11 x 6.67 x 2.54 cm)	A226 K226 ⬢	1	Styrene SBC	20
4-3/8" x 2-5/8" x 1" (11.11 x 6.67 x 2.54 cm)	A228 ⬢	8	Styrene	20
4-3/8" x 2-5/8" x 1" (11.11 x 6.67 x 2.54 cm)	A221 T221 M221 Ⓢ	4	Styrene TP YP	20
4-3/8" x 2-5/8" x 1" (11.11 x 6.67 x 2.54 cm)	A220 T220 K220 ⬢ M220 Ⓢ	6	Styrene TP SBC YP	21
4-1/2" x 2-11/16" x 1" (11.43 x 6.83 x 2.54 cm)	DB221	4	Styrene	21
4-1/2" x 2-11/16" x 1" (11.43 x 6.83 x 2.54 cm)	DB228 ⬢	8	Styrene	21
4-1/2" x 2-11/16" x 1" (11.43 x 6.83 x 2.54 cm)	DB220	6	Styrene	21
4-1/2" x 2-11/16" x 1" (11.43 x 6.83 x 2.54 cm)	DB226	1	Styrene	21
5-1/8" x 3-9/16" x 1-1/2" (13.02 x 9.05 x 3.81 cm)	A101	1	Styrene	21

Inside L x W x D	Model	Fixed Comps	Material	Page
5-5/8" x 2-15/16" x 1-1/8" (14.29 x 7.46 x 2.86 cm)	A154	4	Styrene	21
5-5/8" x 2-15/16" x 1-1/8" (14.29 x 7.46 x 2.86 cm)	A155 T155	5	Styrene TP	21
5-5/8" x 3-5/8" x 1-1/8" (14.29 x 9.21 x 1.91 cm)	3030-2 ⬢	1	SBMM	21
5-7/8" x 3-3/4" x 1-5/8" (14.92 x 9.53 x 4.13 cm)	A250	1	Styrene	21
6-5/8" x 3-3/8" x 1-5/16" (16.83 x 8.57 x 3.33 cm)	T300 ⬢	3	TP	22
6-11/16" x 3-5/16" x 1-5/16" (16.99 x 8.41 x 3.33 cm)	T2003 ⬢	3	TP	22
6-3/4" x 3-3/16" x 1/2" (17.15 x 8.10 x 1.27 cm)	A213-SL	10	Styrene	22
6-3/4" x 3-3/16" x 1/2" (17.15 x 8.10 x 1.27 cm)	A216-SL Ⓢ	1	Styrene	22
6-3/4" x 3-3/16" x 1/2" (17.15 x 8.10 x 1.27 cm)	A210-SL Ⓢ	9	Styrene	22
6-3/4" x 3-3/16" x 1-3/16" (17.15 x 8.10 x 3.02 cm)	A213	10	Styrene	22
6-3/4" x 3-3/16" x 1-3/16" (17.15 x 8.10 x 3.02 cm)	A214	2	Styrene	22
6-3/4" x 3-3/16" x 1-3/16" (17.15 x 8.10 x 3.02 cm)	A215 T215 K215 ⬢ M215 Ⓢ	5	Styrene TP SBC YP	22
6-3/4" x 3-3/16" x 1-3/16" (17.15 x 8.10 x 3.02 cm)	A210 T210 ⬢ K210 ⬢ M210	9	Styrene TP SBC YP	22
6-3/4" x 3-3/16" x 1-3/16" (17.15 x 8.10 x 3.02 cm)	A219 T219 K219 ⬢	12	Styrene TP SBC	22
6-3/4" x 3-3/16" x 1-3/16" (17.15 x 8.10 x 3.02 cm)	A217	7	Styrene	22
6-3/4" x 3-3/16" x 1-3/16" (17.15 x 8.10 x 3.02 cm)	A211 ⬢	6	Styrene	22

COMPARTMENTED BOXES

Compartmented Box Size Reference Chart - continued

BOX MATERIAL KEY					SYMBOL KEY	
TP = Translucent Polypropylene	YP = Yellow Polypropylene	TCP = Transparent Cellulose Propionate			◆ = Blue Diamond	
SP = Taupe Polypropylene	WP = White Polypropylene	SBC = Styrene-Butadiene Copolymer			Ⓢ = Special Order	
OP = Orange Polypropylene		SBMM = Styrene Butadiene Methyl Methacrylate				

Inside L x W x D	Model	Fixed Comps	Material	Page
6-3/4" x 3-3/16" x 1-3/16" (17.15 x 8.10 x 3.02 cm)	A216 ◆ K216	1	Styrene SBC	23
6-3/4" x 3-3/16" x 1-3/16" (17.15 x 8.10 x 3.02 cm)	A212	5	Styrene	23
6-7/8" x 2-1/16" x 1" (17.46 x 5.24 x 2.54 cm)	A701 K701 Ⓢ	1	Styrene SBC	23
7" x 3-1/4" x 1" (17.78 x 8.26 x 2.54 cm)	V301 ◆ V301PT	1	OP SP	23
7" x 3-3/8" x 1-1/8" (17.78 x 8.57 x 2.86 cm)	DB216	1	Styrene	23
7" x 3-3/8" x 1-1/8" (17.78 x 8.57 x 2.86 cm)	DB211	6	Styrene	23
7" x 3-3/8" x 1-1/8" (17.78 x 8.57 x 2.86 cm)	DB219	12	Styrene	23
7" x 3-3/8" x 1-1/8" (17.78 x 8.57 x 2.86 cm)	DB210	9	Styrene	23
7" x 3-3/8" x 1-1/8" (17.78 x 8.57 x 2.86 cm)	DB213 ◆	10	Styrene	24
7" x 3-3/8" x 1-1/8" (17.78 x 8.57 x 2.86 cm)	DB217	7	Styrene	24
7" x 4" x 1-1/16" (17.78 x 10.16 x 2.70 cm)	5126CL	17	TCP	24
7" x 4" x 1-1/16" (17.78 x 10.16 x 2.70 cm)	5127CL	11	TCP	24
7" x 4" x 1-1/16" (17.78 x 10.16 x 2.70 cm)	5128CL	6	TCP	24
7-1/8" x 5-1/8" x 1-9/16" (18.10 x 13.02 x 3.97 cm)	A401	1	Styrene	24
8" x 4" x 1-3/16" (20.32 x 10.16 x 3.02 cm)	A204	12	Styrene	24
8" x 4" x 1-3/16" (20.32 x 10.16 x 3.02 cm)	A206 K206 ◆	1	Styrene SBC	24
8" x 4" x 1-3/16" (20.32 x 10.16 x 3.02 cm)	A209	9	Styrene	24
8" x 4" x 1-3/16" (20.32 x 10.16 x 3.02 cm)	A200 ◆ T200 K200 ◆ M200 Ⓢ	18	Styrene TP SBC YP	25
8" x 4" x 1-3/16" (20.32 x 10.16 x 3.02 cm)	A208 ◆ K208 ◆ M208	12	Styrene SBC YP	25
8" x 4" x 1-3/16" (20.32 x 10.16 x 3.02 cm)	A201 T201 K201 ◆ M201	12	Styrene TP SBC YP	25
8" x 4" x 1-3/16" (20.32 x 10.16 x 3.02 cm)	A203 T203 ◆ K203 ◆ M203	6	Styrene TP SBC YP	25
8-1/8" x 4-1/8" x 1-3/16" (20.64 x 10.48 x 3.02 cm)	V401 ◆	1	SP	25

Inside L x W x D	Model	Fixed Comps	Material	Page
8-1/8" x 4-1/8" x 1-3/16" (20.64 x 10.48 x 3.02 cm)	V402-2 Ⓢ	2	SP	25
8-1/8" x 4-1/8" x 2-5/8" (20.64 x 10.48 x 6.67 cm)	V401D-2 ◆	1	SP	25
8-7/16" x 4-1/4" x 1-3/16" (21.43 x 10.80 x 3.02 cm)	DB201	12	Styrene	25
8-7/16" x 4-1/4" x 1-3/16" (21.43 x 10.80 x 3.02 cm)	DB203	6	Styrene	25
8-7/16" x 4-1/4" x 1-3/16" (21.43 x 10.80 x 3.02 cm)	DB208 ◆	12	Styrene	26
8-7/16" x 4-1/4" x 1-3/16" (21.43 x 10.80 x 3.02 cm)	DB200 ◆	18	Styrene	26
8-1/2" x 4-1/4" x 1-3/16" (21.59 x 10.80 x 3.02 cm)	DB206 Ⓢ	1	Styrene	26
8-1/2" x 4-1/4" x 1-3/16" (21.59 x 10.80 x 3.02 cm)	DB204	12	Styrene	26
8-3/4" x 4-5/16" x 1-1/4" (22.23 x 10.95 x 3.18 cm)	4040-2 ◆	1	SBMM	26
8-7/8" x 4-1/8" x 1-3/16" (22.54 x 10.48 x 3.02 cm)	T3003 ◆	3	TP	26
9-5/8" x 6-9/16" x 1-1/2" (24.45 x 16.69 x 3.81 cm)	A166-36 K166-36 ◆	36	Styrene SBC	26
10" x 4-1/4" x 1-1/2" (25.40 x 10.80 x 3.81 cm)	V501 ◆	1	SP	26
10" x 4-1/4" x 1-1/2" (25.40 x 10.80 x 3.81 cm)	V506-2 Ⓢ	6	SP	26
10-1/2" x 6-3/16" x 1-9/16" (26.67 x 15.72 x 3.97 cm)	T616R K616R Ⓢ M616R Ⓢ	4	TP SBC YP	27
10-1/2" x 6-3/16" x 1-9/16" (26.67 x 15.72 x 3.97 cm)	A623 Ⓢ T623 K623 Ⓢ M623	13	Styrene TP SBC YP	27
10-1/2" x 6-3/16" x 1-9/16" (26.67 x 15.72 x 3.97 cm)	A612 Ⓢ T612 M612	12	Styrene TP YP	27
10-1/2" x 6-3/16" x 1-9/16" (26.67 x 15.72 x 3.97 cm)	A602 T602 K602 M602	12	Styrene TP SBC YP	27
10-1/2" x 6-3/16" x 1-9/16" (26.67 x 15.72 x 3.97 cm)	A606 T606 ◆ K606 ◆ M606	6	Styrene TP SBC YP	27
10-1/2" x 6-3/16" x 1-9/16" (26.67 x 15.72 x 3.97 cm)	A613	13	Styrene	27
10-1/2" x 6-3/16" x 1-9/16" (26.67 x 15.72 x 3.97 cm)	A607 Ⓢ K607 Ⓢ	7	Styrene SBC	27
10-1/2" x 6-3/16" x 1-9/16" (26.67 x 15.72 x 3.97 cm)	T600 ◆	6	TP	27

COMPARTMENTED BOXES

Compartmented Box Size Reference Chart - continued

BOX MATERIAL KEY					SYMBOL KEY	
TP = Translucent Polypropylene	YP = Yellow Polypropylene	TCP = Transparent Cellulose Propionate			◆ = Blue Diamond	
SP = Taupe Polypropylene	WP = White Polypropylene	SBC = Styrene-Butadiene Copolymer			Ⓢ = Special Order	
OP = Orange Polypropylene		SBMM = Styrene Butadiene Methyl Methacrylate				

Inside L x W x D	Model	Fixed Comps	Material	Page
10-1/2" x 6-3/16" x 1-9/16" (26.67 x 15.72 x 3.97 cm)	A601 K601 C601	1	Styrene SBC Conductive	27
10-1/2" x 6-3/16" x 1-9/16" (26.67 x 15.72 x 3.97 cm)	A618 T618 ◆ K618 ◆ M618 C618	18	Styrene TP SBC YP Conductive	28
10-1/2" x 6-3/16" x 1-9/16" (26.67 x 15.72 x 3.97 cm)	A603 Ⓢ	3	Styrene	28
10-1/2" x 6-3/16" x 2-1/4" (26.67 x 15.72 x 5.72 cm)	A612D Ⓢ T612D Ⓢ K612D Ⓢ M612D Ⓢ	12	Styrene TP SBC YP	28
10-1/2" x 6-3/16" x 2-1/4" (26.67 x 15.72 x 5.72 cm)	A618D Ⓢ T618D Ⓢ K618D Ⓢ M618D Ⓢ	18	Styrene TP SBC YP	28
10-1/2" x 6-3/16" x 2-1/4" (26.67 x 15.72 x 5.72 cm)	A601D Ⓢ K601D Ⓢ	1	Styrene SBC	28
10-1/2" x 6-3/16" x 2-1/4" (26.67 x 15.72 x 5.72 cm)	A606D Ⓢ T606D ◆ K606D Ⓢ M606D Ⓢ	6	Styrene TP SBC YP	28
10-9/16" x 8-1/4" x 1-9/16" (26.83 x 20.96 x 3.97 cm)	A924-2	24	Styrene	28
10-5/8" x 6-5/8" x 1-9/16" (26.99 x 16.83 x 3.97 cm)	T4007 ◆	6	TP	28
10-5/8" x 6-5/8" x 1-9/16" (26.99 x 16.83 x 3.97 cm)	T4007AT	6	TP	28
10-5/8" x 6-5/8" x 1-9/16" (26.99 x 16.83 x 3.97 cm)	T4007E ◆	6	TP	29
10-5/8" x 6-5/8" x 1-9/16" (26.99 x 16.83 x 3.97 cm)	T4000	1	TP	29
11" x 6-3/8" x 1-9/16" (27.94 x 16.19 x 3.97 cm)	DB606	6	Styrene	29
11" x 6-3/8" x 1-9/16" (27.94 x 16.19 x 3.97 cm)	DB613 ◆	13	Styrene	29
11" x 6-3/8" x 1-9/16" (27.94 x 16.19 x 3.97 cm)	DB601 Ⓢ	1	Styrene	29
11" x 6-3/8" x 1-9/16" (27.94 x 16.19 x 3.97 cm)	DB618	18	Styrene	29
11-15/16" x 5-15/16" x 1-7/16" (30.32 x 15.08 x 3.65 cm)	5129-1	1	TCP	29
11-15/16" x 5-15/16" x 1-7/16" (30.32 x 15.08 x 3.65 cm)	5129CL	24	TCP	29
11-15/16" x 5-15/16" x 1-7/16" (30.32 x 15.08 x 3.65 cm)	5130CL	6	TCP	29
12-3/4" x 8-1/2" x 2-1/8" (32.39 x 21.59 x 5.40 cm)	A801 K801 ◆ C801	1	Styrene SBC Conductive	30

Inside L x W x D	Model	Fixed Comps	Material	Page
12-3/4" x 8-1/2" x 2-1/8" (32.39 x 21.59 x 5.40 cm)	A812 K812 M812	12	Styrene SBC YP	30
12-3/4" x 8-1/2" x 2-1/8" (32.39 x 21.59 x 5.40 cm)	A824 T824 ◆ K824 ◆ M824 C824	24	Styrene TP SBC YP Conductive	30
12-3/4" x 8-1/2" x 2-1/8" (32.39 x 21.59 x 5.40 cm)	A818 Ⓢ K818 M818	18	Styrene SBC YP	30
12-3/4" x 8-1/2" x 2-1/8" (32.39 x 21.59 x 5.40 cm)	M808 Ⓢ	8	YP	30
12-3/4" x 8-1/2" x 2-1/8" (32.39 x 21.59 x 5.40 cm)	A806 Ⓢ T806 K806 M806	6	Styrene TP SBC YP	30
13-1/8" x 8-7/8" x 1-15/16" (33.34 x 22.54 x 4.92 cm)	T901 Ⓢ	1	TP	30
13-1/8" x 8-7/8" x 1-15/16" (33.34 x 22.54 x 4.92 cm)	999-2	4	TP	30
13-1/8" x 8-7/8" x 1-15/16" (33.34 x 22.54 x 4.92 cm)	T900 ◆	4	TP	30
13-1/2" x 5-3/4" x 2" (34.29 x 14.61 x 5.08 cm)	V601 ◆	1	SP	31
13-11/16" x 8-3/16" x 1-3/4" (34.77 x 20.80 x 4.45 cm)	T5007 ◆	4	TP	31
13-11/16" x 8-3/16" x 1-3/4" (34.77 x 20.80 x 4.45 cm)	T5007AT	4	TP	31
13-11/16" x 8-3/16" x 1-3/4" (34.77 x 20.80 x 4.45 cm)	T5007E ◆	4	TP	31
15-1/4" x 8-7/8" x 1-3/8" (38.74 x 22.54 x 3.49 cm)	T6004 ◆	6	TP	31
15-1/4" x 8-7/8" x 3" (38.74 x 22.54 x 7.62 cm)	T7003	6	TP	31
15-1/4" x 8-7/8" x 3" (38.74 x 22.54 x 7.62 cm)	T7004 ◆	7	TP	31
15-1/4" x 8-7/8" x 3" (38.74 x 22.54 x 7.62 cm)	T7000 ◆	1	TP	31
17" x 7-1/8" x 2" (43.18 x 18.10 x 5.08 cm)	V701 ◆	1	SP	31

COMPARTMENTED BOXES

Compartmented Box Number of Compartments Reference Chart

To help you find what you need we have added a reference chart that lists all of Flambeau's compartmented boxes by how many compartments they have.

BOX MATERIAL KEY			SYMBOL KEY	
TP = Translucent Polypropylene	YP = Yellow Polypropylene	TCP = Transparent Cellulose Propionate	◆ = Blue Diamond	Ⓢ = Special Order
SP = Taupe Polypropylene	WP = White Polypropylene	SBC = Styrene-Butadiene Copolymer		
OP = Orange Polypropylene		SBMM = Styrene Butadiene Methyl Methacrylate		

Fixed Comps	Model	Inside L x W x D	Material	Page
1	2020-2 ◆	3-11/16" x 2-9/16" x 13/16" (9.37 x 6.51 x 2.06 cm)	SBMM	20
1	2040-2 Ⓢ	4" x 3-3/8" x 13/16" (10.16 x 8.57 x 2.06 cm)	WP	20
1	A01 Ⓢ	4-1/4" diameter x 3/4" (10.80 diameter x 1.91 cm)	Styrene	20
1	5200CL	4-5/16" x 2-5/8" x 1-1/16" (10.95 x 6.67 x 2.70 cm)	TCP	20
1	A226 K226 ◆	4-3/8" x 2-5/8" x 1" (11.11 x 6.67 x 2.54 cm)	Styrene SBC	20
1	DB226	4-1/2" x 2-11/16" x 1" (11.43 x 6.83 x 2.54 cm)	Styrene	21
1	A101	5-1/8" x 3-9/16" x 1-1/2" (13.02 x 9.05 x 3.81 cm)	Styrene	21
1	3030-2 ◆	5-5/8" x 3-5/8" x 1-1/8" (14.29 x 9.21 x 2.86 cm)	SBMM	21
1	A250	5-7/8" x 3-3/4" x 1-5/8" (14.92 x 9.53 x 4.13 cm)	Styrene	21
1	A216-SL Ⓢ	6-3/4" x 3-3/16" x 1/2" (17.15 x 8.10 x 1.27 cm)	Styrene	22
1	A216 ◆ K216	6-3/4" x 3-3/16" x 1-3/16" (17.15 x 8.10 x 3.02 cm)	Styrene SBC	23
1	A701 K701 Ⓢ	6-7/8" x 2-1/16" x 1" (17.46 x 5.24 x 2.54 cm)	Styrene SBC	23
1	V301 ◆ V301PT	7" x 3-1/4" x 1" (17.78 x 8.26 x 2.54 cm)	OP SP	23
1	DB216	7" x 3-3/8" x 1-1/8" (17.78 x 8.57 x 2.86 cm)	Styrene	23
1	A401	7-1/8" x 5-1/8" x 1-9/16" (18.10 x 13.02 x 3.97 cm)	Styrene	24
1	A206 K206 ◆	8" x 4" x 1-3/16" (20.32 x 10.16 x 3.02 cm)	Styrene SBC	24
1	V401 ◆	8-1/8" x 4-1/8" x 1-3/16" (20.64 x 10.48 x 3.02 cm)	SP	25
1	V401D-2 ◆	8-1/8" x 4-1/8" x 2-5/8" (20.64 x 10.48 x 6.67 cm)	SP	25
1	DB206 Ⓢ	8-7/16" x 4-1/4" x 1-3/16" (21.43 x 10.80 x 3.02 cm)	Styrene	26
1	4040-2 ◆	8-3/4" x 4-5/16" x 7/8" (22.23 x 10.95 x 2.22 cm)	SBMM	26
1	V501 ◆	10" x 4-1/4" x 1-1/2" (25.40 x 10.80 x 3.81 cm)	SP	26
1	A601 K601 C601	10-1/2" x 6-3/16" x 1-9/16" (26.67 x 15.72 x 3.97 cm)	Styrene SBC Conductive	27
1	A601D Ⓢ K601D Ⓢ	10-1/2" x 6-3/16" x 2-1/4" (26.67 x 15.72 x 5.72 cm)	Styrene SBC	28
1	T4000	10-5/8" x 6-5/8" x 1-9/16" (26.99 x 16.83 x 3.97 cm)	TP	29

Fixed Comps	Model	Inside L x W x D	Material	Page
1	DB601 Ⓢ	11" x 6-3/8" x 1-9/16" (27.94 x 16.19 x 3.97 cm)	Styrene	29
1	5129-1	11-15/16" x 5-15/16" x 1-7/16" (30.32 x 15.08 x 3.65 cm)	TCP	29
1	A801 K801 ◆ C801	12-3/4" x 8-1/2" x 2-1/8" (32.39 x 21.59 x 5.40 cm)	Styrene SBC Conductive	30
1	T901 Ⓢ	13-1/8" x 8-7/8" x 1-15/16" (33.34 x 22.54 x 4.92 cm)	TP	30
1	V601 ◆	13-1/2" x 5-3/4" x 2" (34.29 x 14.61 x 5.08 cm)	SP	31
1	T7000 ◆	15-1/4" x 8-7/8" x 3" (38.74 x 22.54 x 7.62 cm)	TP	31
1	V701 ◆	17" x 7-1/8" x 2" (43.18 x 18.10 x 5.08 cm)	SP	31
2	5202CL	4-5/16" x 2-5/8" x 1-1/16" (10.95 x 6.67 x 2.70 cm)	TCP	20
2	A214	6-3/4" x 3-3/16" x 1-3/16" (17.15 x 8.10 x 3.02 cm)	Styrene	22
2	V402-2 Ⓢ	8-1/8" x 4-1/8" x 1-3/16" (20.64 x 10.48 x 3.02 cm)	SP	25
3	T300 ◆	6-5/8" x 3-3/8" x 1-5/16" (16.83 x 8.57 x 3.33 cm)	TP	22
3	T2003 ◆	6-11/16" x 3-5/16" x 1-5/16" (16.99 x 8.41 x 3.33 cm)	TP	22
3	T3003 ◆	8-7/8" x 4-1/8" x 1-3/16" (22.54 x 10.48 x 3.02 cm)	TP	26
3	A603 Ⓢ	10-1/2" x 6-3/16" x 1-9/16" (26.67 x 15.72 x 3.97 cm)	Styrene	28
4	5204CL	4-5/16" x 2-5/8" x 1-1/16" (10.95 x 6.67 x 2.70 cm)	TCP	20
4	T1002 ◆	4-5/16" x 2-5/8" x 1-1/8" (10.95 x 6.67 x 2.86 cm)	TP	20
4	A221 T221 M221 Ⓢ	4-3/8" x 2-5/8" x 1" (11.11 x 6.67 x 2.54 cm)	Styrene TP YP	20
4	DB221	4-1/2" x 2-11/16" x 1" (11.43 x 6.83 x 2.54 cm)	Styrene	21
4	A154	5-5/8" x 2-15/16" x 1-1/8" (14.29 x 7.46 x 2.86 cm)	Styrene	21
4	T616R K616R Ⓢ M616R Ⓢ	10-1/2" x 6-3/16" x 1-9/16" (26.67 x 15.72 x 3.97 cm)	TP SBC YP	27
4	999-2	13-1/8" x 8-7/8" x 1-15/16" (33.34 x 22.54 x 4.92 cm)	TP	30

COMPARTMENTED BOXES

Compartmented Box Number of Compartments Reference Chart - continued

BOX MATERIAL KEY				SYMBOL KEY	
TP = Translucent Polypropylene	YP = Yellow Polypropylene	TCP = Transparent Cellulose Propionate	 = Blue Diamond  = Special Order		
SP = Taupe Polypropylene	WP = White Polypropylene	SBC = Styrene-Butadiene Copolymer			
OP = Orange Polypropylene		SBMM = Styrene Butadiene Methyl Methacrylate			

Fixed Comps	Model	Inside L x W x D	Material	Page
4	T900 	13-1/8" x 8-7/8" x 1-15/16" (33.34 x 22.54 x 4.92 cm)	TP	30
4	T5007 	13-11/16" x 8-3/16" x 1-3/4" (34.77 x 20.80 x 4.45 cm)	TP	31
4	T5007AT	13-11/16" x 8-3/16" x 1-3/4" (34.77 x 20.80 x 4.45 cm)	TP	31
4	T5007E 	13-11/16" x 8-3/16" x 1-3/4" (34.77 x 20.80 x 4.45 cm)	TP	31
5	A155 T155	5-5/8" x 2-15/16" x 1-1/8" (14.29 x 7.46 x 2.86 cm)	Styrene TP	21
5	A215 T215 K215  M215 	6-3/4" x 3-3/16" x 1-3/16" (17.15 x 8.10 x 3.02 cm)	Styrene TP SBC YP	22
5	A212	6-3/4" x 3-3/16" x 1-3/16" (17.15 x 8.10 x 3.02 cm)	Styrene	23
6	5206CL 	4-5/16" x 2-5/8" x 1-1/16" (10.95 x 6.67 x 2.70 cm)	TCP	20
6	A220 T220 K220  M220 	4-3/8" x 2-5/8" x 1" (11.11 x 6.67 x 2.54 cm)	Styrene TP SBC YP	21
6	DB220	4-1/2" x 2-11/16" x 1" (11.43 x 6.83 x 2.54 cm)	Styrene	21
6	A211 	6-3/4" x 3-3/16" x 1-3/16" (17.15 x 8.10 x 3.02 cm)	Styrene	23
6	DB211	7" x 3-3/8" x 1-1/8" (17.78 x 8.57 x 2.86 cm)	Styrene	23
6	5128CL	7" x 4" x 1-1/16" (17.78 x 10.16 x 2.70 cm)	TCP	24
6	A203 T203  K203  M203	8" x 4" x 1-3/16" (20.32 x 10.16 x 3.02 cm)	Styrene TP SBC YP	25
6	DB203	8-7/16" x 4-1/4" x 1-3/16" (21.43 x 10.80 x 3.02 cm)	Styrene	25
6	V506-2 	10" x 4-1/4" x 1-1/2" (25.40 x 10.80 x 3.81 cm)	SP	25
6	A606 T606  K606  M606	10-1/2" x 6-3/16" x 1-9/16" (26.67 x 15.72 x 3.97 cm)	Styrene TP SBC YP	27
6	T600 	10-1/2" x 6-3/16" x 1-9/16" (26.67 x 15.72 x 3.97 cm)	TP	27
6	A606D  T606D  K606D  M606D 	10-1/2" x 6-3/16" x 2-1/4" (26.67 x 15.72 x 5.72 cm)	Styrene TP SBC YP	28
6	T4007 	10-5/8" x 6-5/8" x 1-9/16" (26.99 x 16.83 x 3.97 cm)	TP	28
6	T4007AT	10-5/8" x 6-5/8" x 1-9/16" (26.99 x 16.83 x 3.97 cm)	TP	28

Fixed Comps	Model	Inside L x W x D	Material	Page
6	T4007E 	10-5/8" x 6-5/8" x 1-9/16" (26.99 x 16.83 x 3.97 cm)	TP	29
6	DB606	11" x 6-3/8" x 1-9/16" (27.94 x 16.19 x 3.97 cm)	Styrene	29
6	5130CL	11-15/16" x 5-15/16" x 1-7/16" (30.32 x 15.08 x 3.65 cm)	TCP	29
6	A806  T806 K806 M806	12-3/4" x 8-1/2" x 2-1/8" (32.39 x 21.59 x 5.40 cm)	Styrene TP SBC YP	30
6	T6004 	15-1/4" x 8-7/8" x 1-3/8" (38.74 x 22.54 x 3.49 cm)	TP	31
6	T7003	15-1/4" x 8-7/8" x 3" (38.74 x 22.54 x 7.62 cm)	TP	31
7	A217	6-3/4" x 3-3/16" x 1-3/16" (17.15 x 8.10 x 3.02 cm)	Styrene	23
7	DB217	7" x 3-3/8" x 1-1/8" (17.78 x 8.57 x 2.86 cm)	Styrene	24
7	A607  K607 	10-1/2" x 6-3/16" x 1-9/16" (26.67 x 15.72 x 3.97 cm)	Styrene SBC	27
7	T7004 	15-1/4" x 8-7/8" x 3" (38.74 x 22.54 x 7.62 cm)	TP	31
8	A228 	4-3/8" x 2-5/8" x 1" (11.11 x 6.67 x 2.54 cm)	Styrene	20
8	DB228 	4-1/2" x 2-11/16" x 1" (11.43 x 6.83 x 2.54 cm)	Styrene	21
8	M808 	12-3/4" x 8-1/2" x 2-1/8" (32.39 x 21.59 x 5.40 cm)	YP	30
9	A210-SL 	6-3/4" x 3-3/16" x 1/2" (17.15 x 8.10 x 1.27 cm)	Styrene	22
9	A210 T210  K210  M210	6-3/4" x 3-3/16" x 1-3/16" (17.15 x 8.10 x 3.02 cm)	Styrene TP SBC YP	22
9	DB210	7" x 3-3/8" x 1-1/8" (17.78 x 8.57 x 2.86 cm)	Styrene	23
9	A209	8" x 4" x 1-3/16" (20.32 x 10.16 x 3.02 cm)	Styrene	24
10	A213-SL	6-3/4" x 3-3/16" x 1/2" (17.15 x 8.10 x 1.27 cm)	Styrene	22
10	A213	6-3/4" x 3-3/16" x 1-3/16" (17.15 x 8.10 x 3.02 cm)	Styrene	22
10	DB213 	7" x 3-3/8" x 1-1/8" (17.78 x 8.57 x 2.86 cm)	Styrene	24
11	5127CL	7" x 4" x 1-1/16" (17.78 x 10.16 x 2.70 cm)	TCP	24
12	A219 T219 K219 	6-3/4" x 3-3/16" x 1-3/16" (17.15 x 8.10 x 3.02 cm)	Styrene TP SBC	23
12	DB219	7" x 3-3/8" x 1-1/8" (17.78 x 8.57 x 2.86 cm)	Styrene	23

COMPARTMENTED BOXES

Compartmented Box Number of Compartments Reference Chart - continued

BOX MATERIAL KEY					SYMBOL KEY	
TP = Translucent Polypropylene	YP = Yellow Polypropylene	TCP = Transparent Cellulose Propionate			◆ = Blue Diamond	
SP = Taupe Polypropylene	WP = White Polypropylene	SBC = Styrene-Butadiene Copolymer			Ⓢ = Special Order	
OP = Orange Polypropylene		SBMM = Styrene Butadiene Methyl Methacrylate				

Fixed Comps	Model	Inside L x W x D	Material	Page
12	A204	8" x 4" x 1-3/16" (20.32 x 10.16 x 3.02 cm)	Styrene	24
12	A208 ◆ K208 ◆ M208	8" x 4" x 1-3/16" (20.32 x 10.16 x 3.02 cm)	Styrene SBC YP	25
12	A201 T201 K201 ◆ M201	8" x 4" x 1-3/16" (20.32 x 10.16 x 3.02 cm)	Styrene TP SBC YP	25
12	DB201	8-7/16" x 4-1/4" x 1-3/16" (21.43 x 10.80 x 3.02 cm)	Styrene	25
12	DB208 ◆	8-7/16" x 4-1/4" x 1-3/16" (21.43 x 10.80 x 3.02 cm)	Styrene	26
12	DB204	8-7/16" x 4-1/4" x 1-3/16" (21.43 x 10.80 x 3.02 cm)	Styrene	26
12	A612 Ⓢ T612 M612	10-1/2" x 6-3/16" x 1-9/16" (26.67 x 15.72 x 3.97 cm)	Styrene TP YP	27
12	A602 T602 K602 M602	10-1/2" x 6-3/16" x 1-9/16" (26.67 x 15.72 x 3.97 cm)	Styrene TP SBC YP	27
12	A612D Ⓢ T612D Ⓢ K612D Ⓢ M612D Ⓢ	10-1/2" x 6-3/16" x 2-1/4" (26.67 x 15.72 x 5.72 cm)	Styrene TP SBC YP	28
12	A812 K812 M812	12-3/4" x 8-1/2" x 2-1/8" (32.39 x 21.59 x 5.40 cm)	Styrene SBC YP	30
13	A623 Ⓢ T623 K623 Ⓢ M623	10-1/2" x 6-3/16" x 1-9/16" (26.67 x 15.72 x 3.97 cm)	Styrene TP SBC YP	27
13	A613	10-1/2" x 6-3/16" x 1-9/16" (26.67 x 15.72 x 3.97 cm)	Styrene	27
13	DB613 ◆	11" x 6-3/8" x 1-9/16" (27.94 x 16.19 x 3.97 cm)	Styrene	29
17	5126CL	7" x 4" x 1-1/16" (17.78 x 10.16 x 2.70 cm)	TCP	24
18	A200 ◆ T200 K200 ◆ M200 Ⓢ	8" x 4" x 1-3/16" (20.32 x 10.16 x 3.02 cm)	Styrene TP SBC YP	25
18	DB200 ◆	8-7/16" x 4-1/4" x 1-3/16" (21.43 x 10.80 x 3.02 cm)	Styrene	26
18	A618 T618 ◆ K618 ◆ M618 C618	10-1/2" x 6-3/16" x 1-9/16" (26.67 x 15.72 x 3.97 cm)	Styrene TP SBC YP Conductive	28

Fixed Comps	Model	Inside L x W x D	Material	Page
18	DB618	11" x 6-3/8" x 1-9/16" (27.94 x 16.19 x 3.97 cm)	Styrene	29
18	A618D Ⓢ T618D Ⓢ K618D Ⓢ M618D Ⓢ	10-1/2" x 6-3/16" x 2-1/4" (26.67 x 15.72 x 5.72 cm)	Styrene TP SBC YP	28
18	A818 Ⓢ K818 M818	12-3/4" x 8-1/2" x 2-1/8" (32.39 x 21.59 x 5.40 cm)	Styrene SBC YP	30
24	A924-2	10-9/16" x 8-1/4" x 1-9/16" (26.83 x 20.96 x 3.97 cm)	Styrene	28
24	5129CL	11-15/16" x 5-15/16" x 1-7/16" (30.32 x 15.08 x 3.65 cm)	TCP	29
24	A824 T824 ◆ K824 ◆ M824 C824	12-3/4" x 8-1/2" x 2-1/8" (32.39 x 21.59 x 5.40 cm)	Styrene TP SBC YP Conductive	30
36	A166-36 K166-36 ◆	9-5/8" x 6-9/16" x 1-1/2" (24.45 x 16.69 x 3.81 cm)	Styrene SBC	26

COMPARTMENTED BOXES

Boxes 3-11/16" x 2-9/16" x 13/16" through 4-3/8" x 2-5/8" x 1"
(9.37 x 6.51 x 2.06 cm) through (11.11 x 6.67 x 2.54 cm)

BOX MATERIAL KEY					SYMBOL KEY	
TP = Translucent Polypropylene	YP = Yellow Polypropylene	TCP = Transparent Cellulose Propionate			 = Blue Diamond	
SP = Taupe Polypropylene	WP = White Polypropylene	SBC = Styrene-Butadiene Copolymer			 = Special Order	
OP = Orange Polypropylene		SBMM = Styrene Butadiene Methyl Methacrylate				

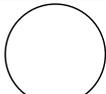
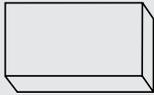
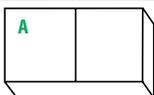
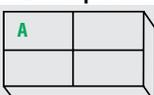
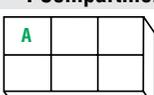
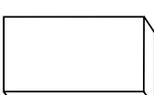
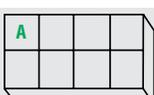
Box Diagram	Model Number	Stock Number	Family	Material	Dimensions (Inside, L x W x D)	Packed
 1 Compartment	2020-2 	6240AA	 Precision	SBMM	3-11/16" x 2-9/16" x 13/16" (9.37 x 6.51 x 2.06 cm)	24/ctn
 1 Compartment	2040-2 	6242FA	--	WP	4" x 3-3/8" x 13/16" (10.16 x 8.57 x 2.06 cm)	36/ctn
 1 Compartment	A01 	6685CC	 A-Series	Styrene	4-1/4" diameter x 3/4" (10.80 diameter x 1.91 cm)	80/ctn
 1 Compartment	5200CL	6230MT	 Mighty-Tuff	TCP	4-5/16" x 2-5/8" x 1-1/16" (10.95 x 6.67 x 2.70 cm)	12/ctn
 2 Compartments (L x W): A= 2-1/8" x 2-5/8" (5.40 x 6.67 cm)	5202CL	6232MT	 Mighty-Tuff	TCP	4-5/16" x 2-5/8" x 1-1/16" (10.95 x 6.67 x 2.70 cm)	12/ctn
 4 Compartments (L x W): A= 2-1/8" x 1-1/4" (5.40 x 3.18 cm)	5204CL	6234MT	 Mighty-Tuff	TCP	4-5/16" x 2-5/8" x 1-1/16" (10.95 x 6.67 x 2.70 cm)	12/ctn
 6 Compartments (L x W): A= 1-3/8" x 1-5/16" (3.49 x 3.33 cm)	5206CL 	6236MT	 Mighty-Tuff	TCP	4-5/16" x 2-5/8" x 1-1/16" (10.95 x 6.67 x 2.70 cm)	12/ctn
 4 Compartments & 2 Removable Dividers (L x W): A= 3" x 1-1/4" (7.62 x 3.18 cm), B= 1-1/4" x 1-1/4" (3.18 x 3.18 cm)	T1002 	6709TE	 Tuff Tainer	TP	4-5/16" x 2-5/8" x 1-1/8" (10.95 x 6.67 x 2.86 cm)	12/ctn
 1 Compartment	A226 K226 	6644CB 6644KB	 A-Series  K-Series	Styrene SBC	4-3/8" x 2-5/8" x 1" (11.11 x 6.67 x 2.54 cm)	36/ctn
 8 Compartments (L x W): A= 1" x 1-1/4" (2.54 x 3.18 cm)	A228 	6646CB	 A-Series	Styrene	4-3/8" x 2-5/8" x 1" (11.11 x 6.67 x 2.54 cm)	36/ctn
 4 Compartments (L x W): A= 2-3/16" x 1-5/16" (5.56 x 3.33 cm)	A221 T221 M221 	6642CB 6706TE 6706TF	 A-Series  T-Series  M-Series	Styrene TP YP	4-3/8" x 2-5/8" x 1" (11.11 x 6.67 x 2.54 cm)	36/ctn

* Adding color to the resins effects the clarity of the finished product

Boxes 4-3/8" x 2-5/8" x 1" through 5-7/8" x 3-3/4" x 1-5/8"
 (11.11 x 6.67 x 2.54 cm) through (14.92 x 9.53 x 4.13 cm)

COMPARTMENTED BOXES

BOX MATERIAL KEY			SYMBOL KEY
TP = Translucent Polypropylene	YP = Yellow Polypropylene	TCP = Transparent Cellulose Propionate	◆ = Blue Diamond
SP = Taupe Polypropylene	WP = White Polypropylene	SBC = Styrene-Butadiene Copolymer	Ⓢ = Special Order
OP = Orange Polypropylene		SBMM = Styrene Butadiene Methyl Methacrylate	

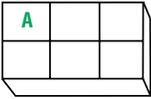
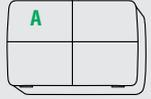
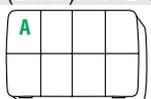
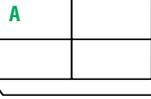
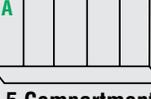
Box Diagram	Model Number	Stock Number	Family	Material	Dimensions (Inside, L x W x D)	Packed
 <p>6 Compartments (L x W): A= 1-3/8" x 1-1/4" (3.49 x 3.18 cm)</p>	A220	6640CB	A-Series	Styrene	4-3/8" x 2-5/8" x 1" (11.11 x 6.67 x 2.54 cm)	36/ctn
	T220	6704TE	T-Series	TP		
	K220 ◆	6640KB	K-Series	SBC		
	M220 Ⓢ	6704TF	M-Series	YP		
 <p>4 Compartments (L x W): A= 2-3/16" x 1-5/16" (5.56 x 3.33 cm)</p>	DB221	6742CD	Diamondback	Styrene	4-1/2" x 2-11/16" x 1" (11.43 x 6.83 x 2.54 cm)	24/ctn
	DB228 ◆	6746CD	Diamondback	Styrene	4-1/2" x 2-11/16" x 1" (11.43 x 6.83 x 2.54 cm)	24/ctn
 <p>6 Compartments (L x W): A= 1-1/16" x 1-5/16" (2.70 x 3.33 cm)</p>	DB220	6740CD	Diamondback	Styrene	4-1/2" x 2-11/16" x 1" (11.43 x 6.83 x 2.54 cm)	24/ctn
	DB226	6744CD	Diamondback	Styrene	4-1/2" x 2-11/16" x 1" (11.43 x 6.83 x 2.54 cm)	24/ctn
 <p>1 Compartment</p>	A101	6600CB	A-Series	Styrene	5-1/8" x 3-9/16" x 1-1/2" (13.02 x 9.05 x 3.81 cm)	36/ctn
 <p>4 Compartments (L x W): A= 2-3/4" x 1-7/16" (6.99 x 3.65 cm)</p>	A154	6602CB	A-Series	Styrene	5-5/8" x 2-15/16" x 1-1/8" (14.29 x 7.46 x 2.86 cm)	36/ctn
	A155	6604CB	A-Series	Styrene	5-5/8" x 2-15/16" x 1-1/8" (14.29 x 7.46 x 2.86 cm)	36/ctn
T155	6688TE	T-Series	TP			
 <p>5 Compartments (L x W): A= 1" x 2-7/8" (2.54 x 7.30 cm)</p>	3030-2 ◆	6730AA	Precision	SBMM	5-5/8" x 3-5/8" x 1-1/8" (14.29 x 9.21 x 2.86 cm)	36/ctn
 <p>1 Compartment</p>	A250	6648CB	A-Series	Styrene	5-7/8" x 3-3/4" x 1-5/8" (14.92 x 9.53 x 4.13 cm)	36/ctn
1 Compartment, Box has Lift-Off Lid (Non-Hinged)						

* Adding color to the resins effects the clarity of the finished product

COMPARTMENTED BOXES

Boxes 6-5/8" x 3-3/8" x 1-5/16" through 6-3/4" x 3-3/16" x 1-3/16"
(16.83 x 8.57 x 3.33 cm) through (17.15 x 8.10 x 3.02 cm)

BOX MATERIAL KEY					SYMBOL KEY	
TP = Translucent Polypropylene	YP = Yellow Polypropylene	TCP = Transparent Cellulose Propionate			◆ = Blue Diamond	
SP = Taupe Polypropylene	WP = White Polypropylene	SBC = Styrene-Butadiene Copolymer			Ⓢ = Special Order	
OP = Orange Polypropylene		SBMM = Styrene Butadiene Methyl Methacrylate				

Box Diagram	Model Number	Stock Number	Family	Material	Dimensions (Inside, L x W x D)	Packed
	T300 ◆	6715ID	■ IDS	TP	6-5/8" x 3-3/8" x 1-5/16" (16.83 x 8.57 x 3.33 cm)	12/ctn
3 Compartments & 6 IDS Dividers (Ref. page 34) (L x W): A= 6-5/8" x 1-1/16" (16.83 x 2.70 cm)						
	T2003 ◆	6703TE	■ Tuff Tainer	TP	6-11/16" x 3-5/16" x 1-5/16" (16.99 x 8.41 x 3.33 cm)	12/ctn
3 Compartments & 15 Removable Dividers (L x W): A= 6-11/16" x 1-1/16" (16.99 x 2.70 cm)						
	A213-SL	6627CS	■ A-Series	Styrene	6-3/4" x 3-3/16" x 1/2" (17.15 x 8.10 x 1.27 cm)	36/ctn
10 Compartments (L x W): A= 1-1/2" x 1-5/8" (3.81 x 4.13 cm), B= 1-7/16" x 1-5/8" (3.65 x 4.13 cm), C= 1-5/16" x 1-5/8" (3.33 x 4.13 cm), D= 1-1/4" x 1-5/8" (3.18 x 4.13 cm), E= 1-1/8" x 1-5/8" (2.86 x 4.13 cm)						
	A216-SL Ⓢ	6632CS	■ A-Series	Styrene	6-3/4" x 3-3/16" x 1/2" (17.15 x 8.10 x 1.27 cm)	36/ctn
1 Compartment						
	A210-SL Ⓢ	6622CS	■ A-Series	Styrene	6-3/4" x 3-3/16" x 1/2" (17.15 x 8.10 x 1.27 cm)	36/ctn
9 Compartments (L x W): A= 1-1/8" x 1-5/8" (2.86 x 4.13 cm), B= 1-1/8" x 3-3/8" (2.86 x 8.57 cm)						
	A213	6621CM	■ A-Series	Styrene	6-3/4" x 3-3/16" x 1-3/16" (17.15 x 8.10 x 3.02 cm)	36/ctn
10 Compartments (L x W): A= 1-1/2" x 1-5/8" (3.81 x 4.13 cm), B= 1-7/16" x 1-5/8" (3.65 x 4.13 cm), C= 1-5/16" x 1-5/8" (3.33 x 4.13 cm), D= 1-1/4" x 1-5/8" (3.18 x 4.13 cm), E= 1-1/8" x 1-5/8" (2.86 x 4.13 cm)						
	A214	6628CB	■ A-Series	Styrene	6-3/4" x 3-3/16" x 1-3/16" (17.15 x 8.10 x 3.02 cm)	36/ctn
2 Compartments (L x W): A= 3-5/16" x 3-1/4" (8.41 x 8.26 cm)						
	A215	6630CB	■ A-Series	Styrene	6-3/4" x 3-3/16" x 1-3/16" (17.15 x 8.10 x 3.02 cm)	36/ctn
	T215	6702TE	■ T-Series	TP		
	K215 ◆	6630KB	■ K-Series	SBC		
	M215 Ⓢ	6702TF	■ M-Series	YP		
	5 Compartments (L x W): A= 1-5/16" x 3-3/16" (3.33 x 8.10 cm)					
	A210	6622CB	■ A-Series	Styrene	6-3/4" x 3-3/16" x 1-3/16" (17.15 x 8.10 x 3.02 cm)	36/ctn
	T210 ◆	6698TE	■ T-Series	TP		
	K210 ◆	6622KB	■ K-Series	SBC		
	M210	6698TF	■ M-Series	YP		
	9 Compartments (L x W): A= 1-5/16" x 1-9/16" (3.33 x 3.97 cm), B= 1-1/8" x 3-3/16" (2.86 x 8.10 cm)					
	A219	6636CB	■ A-Series	Styrene	6-3/4" x 3-3/16" x 1-3/16" (17.15 x 8.10 x 3.02 cm)	36/ctn
	T219	6701TE	■ T-Series	TP		
	K219 ◆	6636KB	■ K-Series	SBC		
	12 Compartments (L x W): A= 1-7/16" x 1-1/16" (3.65 x 2.70 cm)					

* Adding color to the resins effects the clarity of the finished product

Boxes 6-3/4" x 3-3/16" x 1-3/16" through 7" x 3-3/8" x 1-1/8"
(17.15 x 8.10 x 3.02 cm) through (17.78 x 8.57 x 2.86 cm)

COMPARTMENTED BOXES

BOX MATERIAL KEY			SYMBOL KEY
TP = Translucent Polypropylene	YP = Yellow Polypropylene	TCP = Transparent Cellulose Propionate	◆ = Blue Diamond
SP = Taupe Polypropylene	WP = White Polypropylene	SBC = Styrene-Butadiene Copolymer	Ⓢ = Special Order
OP = Orange Polypropylene		SBMM = Styrene Butadiene Methyl Methacrylate	

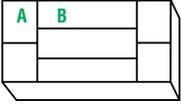
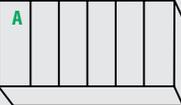
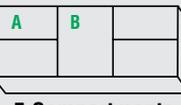
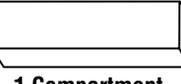
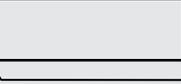
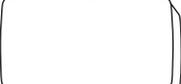
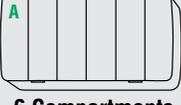
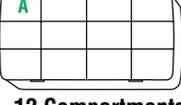
Box Diagram	Model Number	Stock Number	Family	Material	Dimensions (Inside, L x W x D)	Packed
	A217	6634CB	A-Series	Styrene	6-3/4" x 3-3/16" x 1-3/16" (17.15 x 8.10 x 3.02 cm)	36/ctn
7 Compartments (L x W): A = 1-5/16" x 1-5/8" (3.33 x 4.13 cm), B = 4" x 1-1/16" (10.16 x 2.70 cm)						
	A211 ◆	6624CB	A-Series	Styrene	6-3/4" x 3-3/16" x 1-3/16" (17.15 x 8.10 x 3.02 cm)	36/ctn
6 Compartments (L x W): A = 1-1/16" x 3-3/16" (2.70 x 8.10 cm)						
	A216 ◆ K216	6632CB 6632KB	A-Series K-Series	Styrene SBC	6-3/4" x 3-3/16" x 1-3/16" (17.15 x 8.10 x 3.02 cm)	36/ctn
1 Compartment						
	A212	6626CB	A-Series	Styrene	6-3/4" x 3-3/16" x 1-3/16" (17.15 x 8.10 x 3.02 cm))	36/ctn
5 Compartments (L x W): A = 2-1/2" x 1-5/8" (6.35 x 4.13 cm), B = 1-5/8" x 3-1/4" (4.13 x 8.26 cm)						
	A701 K701 Ⓢ	6670CB 6670KB	A-Series K-Series	Styrene SBC	6-7/8" x 2-1/16" x 1" (17.46 x 5.24 x 2.54 cm)	36/ctn
1 Compartment						
	V301 ◆ V301PT	6142VB 6650VC	V-Series V-Series	OP SP	6-7/8" x 2-1/16" x 1" (17.46 x 5.24 x 2.54 cm)	36/ctn
1 Compartment						
	DB216	6732CD	Diamondback	Styrene	7" x 3-3/8" x 1-1/8" (17.78 x 8.57 x 2.86 cm)	25/ctn
1 Compartment						
	DB211	6724CD	Diamondback	Styrene	7" x 3-3/8" x 1-1/8" (17.78 x 8.57 x 2.86 cm)	25/ctn
6 Compartments (L x W): A = 1-1/16" x 3-5/16" (2.70 x 8.41 cm)						
	DB219	6736CD	Diamondback	Styrene	7" x 3-3/8" x 1-1/8" (17.78 x 8.57 x 2.86 cm)	225/ctn
12 Compartments (L x W): A = 1-3/4" x 1-1/16" (4.45 x 2.70 cm)						
	DB210	6722CD	Diamondback	Styrene	7" x 3-3/8" x 1-1/8" (17.78 x 8.57 x 2.86 cm)	25/ctn
9 Compartments (L x W): A = 1-3/8" x 1-5/8" (3.49 x 4.13 cm), B = 1-5/16" x 1-5/8" (3.33 x 4.13 cm), C = 1-5/16" x 3-5/16" (3.33 x 8.41 cm)						

* Adding color to the resins effects the clarity of the finished product

For Customer Service Inquiries Call 1-800-344-5716

COMPARTMENTED BOXES

Boxes 7" x 3-3/8" x 1-1/8" through 8" x 4" x 1-3/16"
(17.78 x 8.57 x 2.86 cm) through (20.32 x 10.16 x 3.02 cm)

BOX MATERIAL KEY					SYMBOL KEY	
TP = Translucent Polypropylene	YP = Yellow Polypropylene	TCP = Transparent Cellulose Propionate				= Blue Diamond
SP = Taupe Polypropylene	WP = White Polypropylene	SBC = Styrene-Butadiene Copolymer				= Special Order
OP = Orange Polypropylene		SBMM = Styrene Butadiene Methyl Methacrylate				

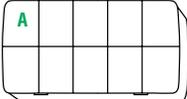
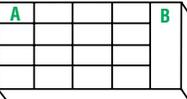
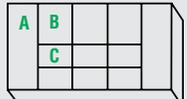
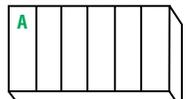
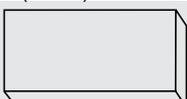
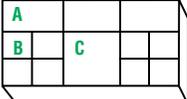
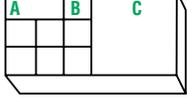
Box Diagram	Model Number	Stock Number	Family	Material	Dimensions (Inside, L x W x D)	Packed
 10 Compartments (L x W): A = 1-5/16" x 1-5/8" (3.33 x 4.13 cm)	DB213 	6721CD	 Diamondback	Styrene	7" x 3-3/8" x 1-1/8" (17.78 x 8.57 x 2.86 cm)	25/ctn
 7 Compartments (L x W): A = 1-5/16" x 1-5/8" (3.33 x 4.13 cm), B = 4-1/8" x 1-1/8" (10.48 x 2.86 cm)	DB217	6734CD	 Diamondback	Styrene	7" x 3-3/8" x 1-1/8" (17.78 x 8.57 x 2.86 cm)	25/ctn
 17 Compartments (L x W): A = 1-1/4" x 7/8" (3.18 x 2.22 cm), B = 1-3/16" x 4" (3.02 x 10.16 cm)	5126CL	6220MT	 Mighty-Tuff	TCP	7" x 4" x 1-1/16" (17.78 x 10.16 x 2.70 cm)	12/ctn
 11 Compartments (L x W): A = 1-3/16" x 4" (3.02 x 10.16 cm), B = 1-1/4" x 2" (3.18 x 5.08 cm), C = 1-1/4" x 7/8" (3.18 x 2.22 cm)	5127CL	6222MT	 Mighty-Tuff	TCP	7" x 4" x 1-1/16" (17.78 x 10.16 x 2.70 cm)	12/ctn
 6 Compartments (L x W): A = 1-3/16" x 4" (3.02 x 10.16 cm)	5128CL	6224MT	 Mighty-Tuff	TCP	7" x 4" x 1-1/16" (17.78 x 10.16 x 2.70 cm)	12/ctn
 1 Compartment	A401	6650CB	 A-Series	Styrene	7-1/8" x 5-1/8" x 1-9/16" (18.10 x 13.02 x 3.97 cm)	36/ctn
 12 Compartments (L x W): A = 2-5/8" x 1-5/16" (6.67 x 3.33 cm), B = 1-5/16" x 1-1/4" (3.33 x 3.18 cm), C = 2-5/8" x 2-11/16" (6.67 x 6.83 cm)	A204	6614CB	 A-Series	Styrene	8" x 4" x 1-3/16" (20.32 x 10.16 x 3.02 cm)	24/ctn
 1 Compartment	A206 K206 	6616CB 6616KB	 A-Series  K-Series	Styrene SBC	8" x 4" x 1-3/16" (20.32 x 10.16 x 3.02 cm)	24/ctn
 9 Compartments (L x W): A = 2-5/8" x 1-5/16" (6.67 x 3.33 cm), B = 1-1/4" x 1-5/16" (3.18 x 3.33 cm), C = 4" x 4" (10.16 x 10.16 cm)	A209	6620CB	 A-Series	Styrene	8" x 4" x 1-3/16" (20.32 x 10.16 x 3.02 cm)	24/ctn

* Adding color to the resins effects the clarity of the finished product

Boxes 8" x 4" x 1-3/16" through 8-7/16" x 4-1/4" x 1-3/16"
 (20.32 x 10.16 x 3.02 cm) through (21.43 x 10.80 x 3.02 cm)

COMPARTMENTED BOXES

BOX MATERIAL KEY			SYMBOL KEY
TP = Translucent Polypropylene	YP = Yellow Polypropylene	TCP = Transparent Cellulose Propionate	◆ = Blue Diamond
SP = Taupe Polypropylene	WP = White Polypropylene	SBC = Styrene-Butadiene Copolymer	Ⓢ = Special Order
OP = Orange Polypropylene		SBMM = Styrene Butadiene Methyl Methacrylate	

Box Diagram	Model Number	Stock Number	Family	Material	Dimensions (Inside, L x W x D)	Packed
	A200 ◆ T200 K200 ◆ M200 Ⓢ	6608CB 6690TE 6608KB 6690TF	A-Series T-Series K-Series M-Series	Styrene TP SBC YP	8" x 4" x 1-3/16" (20.32 x 10.16 x 3.02 cm)	24/ctn
	A208 ◆ K208 ◆ M208	6618CB 6618KB 6696TF	A-Series K-Series M-Series	Styrene SBC YP	8" x 4" x 1-3/16" (20.32 x 10.16 x 3.02 cm)	24/ctn
	A201 T201 K201 ◆ M201	6610CB 6692TE 6610KB 6692TF	A-Series T-Series K-Series M-Series	Styrene TP SBC YP	8" x 4" x 1-3/16" (20.32 x 10.16 x 3.02 cm)	24/ctn
12 Compartments (L x W): A = 1-5/16" x 1-5/16" (3.33 x 3.33 cm), B = 1-5/16" x 4" (3.33 x 10.16 cm), C = 1-5/16" x 2" (3.33 x 5.08 cm)						
	A203 T203 ◆ K203 ◆ M203	6612CB 6694TE 6612KB 6694TF	A-Series T-Series K-Series M-Series	Styrene TP SBC YP	8" x 4" x 1-3/16" (20.32 x 10.16 x 3.02 cm)	24/ctn
6 Compartments (L x W): A = 1-1/4" x 4" (3.18 x 10.16 cm)						
	V401 ◆	6152VB	V-Series	SP	8-1/8" x 4-1/8" x 1-3/16" (20.64 x 10.48 x 3.02 cm)	24/ctn
1 Compartment						
	V402-2 Ⓢ	6655VA	V-Series	SP	8-1/8" x 4-1/8" x 1-3/16" (20.64 x 10.48 x 3.02 cm)	24/ctn
2 Compartments (L x W): A = 8-1/4" x 1-1/4" (20.96 x 10.16 cm)						
	V401D-2 ◆	6654DV	V-Series	SP	8-1/8" x 4-1/8" x 2-5/8" (20.64 x 10.48 x 6.67 cm)	24/ctn
1 Compartment						
	DB201	6710CD	Diamondback	Styrene	8-7/16" x 4-1/4" x 1-3/16" (21.43 x 10.80 x 3.02 cm)	24/ctn
12 Compartments (L x W): A = 1-5/16" x 1-5/16" (3.33 x 3.33 cm), B = 1-5/16" x 4-1/4" (3.33 x 10.80 cm), C = 1-5/16" x 2-1/16" (3.33 x 5.24 cm)						
	DB203	6712CD	Diamondback	Styrene	8-7/16" x 4-1/4" x 1-3/16" (21.43 x 10.80 x 3.02 cm)	24/ctn
6 Compartments (L x W): A = 1-3/8" x 4-1/4" (3.49 x 10.80 cm), B = 1-5/16" x 4-1/4" (3.33 x 10.80 cm)						

* Adding color to the resins effects the clarity of the finished product

COMPARTMENTED BOXES

Boxes 8-7/16" x 4-1/4" x 1-3/16" through 10" x 4-1/4" x 1-1/2"
(21.43 x 10.80 x 3.02 cm) through (25.40 x 10.80 x 3.81 cm)

BOX MATERIAL KEY					SYMBOL KEY	
TP = Translucent Polypropylene	YP = Yellow Polypropylene	TCP = Transparent Cellulose Propionate			 = Blue Diamond	
SP = Taupe Polypropylene	WP = White Polypropylene	SBC = Styrene-Butadiene Copolymer			 = Special Order	
OP = Orange Polypropylene		SBMM = Styrene Butadiene Methyl Methacrylate				

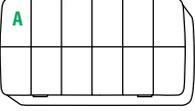
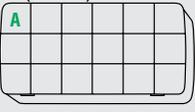
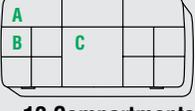
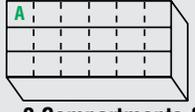
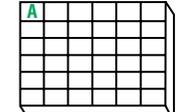
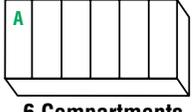
Box Diagram	Model Number	Stock Number	Family	Material	Dimensions (Inside, L x W x D)	Packed
 12 Compartments (L x W): A = 1-3/8" x 2-1/16" (3.49 x 5.24 cm)	DB208 	6718CD	 Diamondback	Styrene	8-7/16" x 4-1/4" x 1-3/16" (21.43 x 10.80 x 3.02 cm)	48/ctn
 18 Compartments (L x W): A = 1-3/8" x 1-3/8" (3.49 x 3.49 cm)	DB200 	6708CD	 Diamondback	Styrene	8-7/16" x 4-1/4" x 1-3/16" (21.43 x 10.80 x 3.02 cm)	24/ctn
 1 Compartment	DB206 	6716CD	 Diamondback	Styrene	8-7/16" x 4-1/4" x 1-3/16" (21.43 x 10.80 x 3.02 cm)	24/ctn
 12 Compartments (L x W): A = 2-3/4" x 1-3/8" (6.99 x 3.49 cm), B = 1-3/8" x 1-3/8" (3.49 x 3.49 cm), C = 2-3/4" x 2-3/4" (6.99 x 6.99 cm)	DB204	6714CD	 Diamondback	Styrene	8-7/16" x 4-1/4" x 1-3/16" (21.43 x 10.80 x 3.02 cm)	24/ctn
 1 Compartment	4040-2 	6740AA	 Precision	SBMM	8-3/4" x 4-5/16" x 1-1/4" (22.23 x 10.95 x 3.18 cm)	24/ctn
 3 Compartments & 15 Removable Dividers (L x W): A = 8-7/8" x 1-3/8" (22.54 x 3.49 cm)	T3003 	6707TE	 Tuff Tainer	TP	8-7/8" x 4-1/8" x 1-3/16" (22.54 x 10.48 x 3.02 cm)	12/ctn
 36 Compartments (L x W): A = 1-9/16" x 1-1/16" (3.97 x 2.70 cm)	A166-36 K166-36 	6606CB 6606KB	 A-Series  K-Series	Styrene SBC	9-5/8" x 6-9/16" x 1-1/2" (24.45 x 16.69 x 3.81 cm)	12/ctn 24/ctn
 1 Compartment	V501 	6160VB	 V-Series	SP	10" x 4-1/4" x 1-1/2" (25.40 x 10.80 x 3.81 cm)	24/ctn
 6 Compartments (L x W): A = 1-5/8" x 4-1/4" (4.13 x 10.80 cm)	V506-2 	6660VA	 V-Series	SP	10" x 4-1/4" x 1-1/2" (25.40 x 10.80 x 3.81 cm)	24/ctn

* Adding color to the resins effects the clarity of the finished product

Boxes 10-1/2" x 6-3/16" x 1-9/16" through 10-1/2" x 6-3/16" x 1-9/16"
(26.67 x 15.72 x 33.97 cm) through (26.67 x 15.72 x 3.97 cm)

COMPARTMENTED BOXES

BOX MATERIAL KEY			SYMBOL KEY	
TP = Translucent Polypropylene	YP = Yellow Polypropylene	TCP = Transparent Cellulose Propionate	◆ = Blue Diamond	Ⓢ = Special Order
SP = Taupe Polypropylene	WP = White Polypropylene	SBC = Styrene-Butadiene Copolymer		
OP = Orange Polypropylene		SBMM = Styrene Butadiene Methyl Methacrylate		

Box Diagram	Model Number	Stock Number	Family	Material	Dimensions (Inside, L x W x D)	Packed
	T616R K616R Ⓢ M616R Ⓢ	6713TE 6665KB 6713TF	T-Series K-Series M-Series	TP SBC YP	10-1/2" x 6-3/16" x 1-9/16" (26.67 x 15.72 x 3.97 cm)	24/ctn
4 Compartments & 12 Removable Dividers (L x W): A= 10-3/8" x 1-1/2" (26.35 x 3.81 cm)						
	A623 Ⓢ T623 K623 Ⓢ M623	6668CB 6715TE 6668KB 6716TF	A-Series T-Series K-Series M-Series	Styrene TP SBC YP	10-1/2" x 6-3/16" x 1-9/16" (26.67 x 15.72 x 3.97 cm)	24/ctn
13 Compartments (L x W): A= 10-3/8" x 2-5/8" (26.35 x 6.67 cm), B= 1-11/16" x 1-5/16" (4.29 x 3.33 cm), C= 1-11/16" x 2" (4.29 x 5.08 cm)						
	A612 Ⓢ T612 M612	6662CB 6712TE 6712TF	A-Series T-Series M-Series	Styrene TP YP	10-1/2" x 6-3/16" x 1-9/16" (26.67 x 15.72 x 3.97 cm)	24/ctn
12 Compartments (L x W): A= 1-11/16" x 2" (4.29 x 5.08 cm), B= 1-11/16" x 4-1/8" (4.29 x 10.48 cm)						
	A602 T602 K602 M602	6654CB 6708TE 6654KB 6708TF	A-Series T-Series K-Series M-Series	Styrene TP SBC YP	10-1/2" x 6-3/16" x 1-9/16" (26.67 x 15.72 x 3.97 cm)	24/ctn
12 Compartments (L x W): A= 1-11/16" x 3-1/16" (4.29 x 7.78 cm)						
	A606 T606 ◆ K606 ◆ M606	6658CB 6710TE 6658KB 6710TF	A-Series T-Series K-Series M-Series	Styrene TP SBC YP	10-1/2" x 6-3/16" x 1-9/16" (26.67 x 15.72 x 3.97 cm)	24/ctn
6 Compartments (L x W): A= 1-11/16" x 6-1/4" (4.29 x 15.88 cm)						
	A613	6664CB	A-Series	Styrene	10-1/2" x 6-3/16" x 1-9/16" (26.67 x 15.72 x 3.97 cm)	24/ctn
13 Compartments (L x W): A= 1-11/16" x 2" (4.29 x 5.08 cm), B= 1-11/16" x 4-1/16" (4.29 x 10.32 cm), C= 3-1/2" x 4-1/16" (8.89 x 10.32 cm)						
	A607 Ⓢ K607 Ⓢ	6660CB 6660KB	A-Series K-Series	Styrene SBC	10-1/2" x 6-3/16" x 1-9/16" (26.67 x 15.72 x 3.97 cm)	24/ctn
7 Compartments (L x W): A= 1-11/16" x 2" (4.29 x 5.08 cm), B= 10-1/2" x 4-1/16" (26.67 x 10.32 cm)						
	T600 ◆	6719ID	IDS	TP	10-1/2" x 6-3/16" x 1-9/16" (26.67 x 15.72 x 3.97 cm)	6/ctn
6 Compartments & 10 IDS Dividers (Ref. page 34) (L x W): A= 1-11/16" x 6-3/16" (4.29 x 15.72 cm)						
	A601 K601 C601	6652CB 6652KB 6707TC	A-Series K-Series --	Styrene SBC Conductive	10-1/2" x 6-3/16" x 1-9/16" (26.67 x 15.72 x 3.97 cm)	24/ctn
1 Compartment						

* Adding color to the resins effects the clarity of the finished product

COMPARTMENTED BOXES

Boxes 10-1/2" x 6-3/16" x 1-9/16" through 10-5/8" x 6-5/8" x 1-9/16"
(26.67 x 15.72 x 3.97 cm) through (26.99 x 16.83 x 3.97 cm)

BOX MATERIAL KEY					SYMBOL KEY	
TP = Translucent Polypropylene	YP = Yellow Polypropylene	TCP = Transparent Cellulose Propionate			 = Blue Diamond	
SP = Taupe Polypropylene	WP = White Polypropylene	SBC = Styrene-Butadiene Copolymer			 = Special Order	
OP = Orange Polypropylene		SBMM = Styrene Butadiene Methyl Methacrylate				

Box Diagram	Model Number	Stock Number	Family	Material	Dimensions (Inside, L x W x D)	Packed
-------------	--------------	--------------	--------	----------	--------------------------------	--------

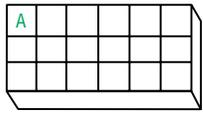
	A618 T618  K618  M618 C618	6666CB 6714TE 6666KB 6714TF 6714TC	A-Series T-Series K-Series M-Series --	Styrene TP SBC YP Conductive	10-1/2" x 6-3/16" x 1-9/16" (26.67 x 15.72 x 3.97 cm)	24/ctn
18 Compartments (L x W): A= 1-3/4" x 2-1/16" (4.45 x 5.24 cm)						

	A603 	6656CB	A-Series	Styrene	10-1/2" x 6-3/16" x 1-9/16" (26.67 x 15.72 x 3.97 cm)	24/ctn
3 Compartments (L x W): A= 10-1/2" x 2-1/16" (26.67 x 5.24 cm)						

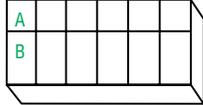
	A612D  T612D  K612D  M612D 	6662DB 6713DB 6663DK 6712DB	A-Series T-Series K-Series M-Series	Styrene TP SBC YP	10-1/2" x 6-3/16" x 2-1/4" (26.67 x 15.72 x 5.72 cm)	24/ctn
12 Compartments (L x W): A= 1-11/16" x 2" (4.29 x 5.08 cm), B= 1-11/16" x 4-1/8" (4.29 x 10.48 cm)						

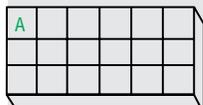
	A618D  T618D  K618D  M618D 	6666DB 6715DB 6666DK 6714DB	A-Series T-Series K-Series M-Series	Styrene TP SBC YP	10-1/2" x 6-3/16" x 2-1/4" (26.67 x 15.72 x 5.72 cm)	24/ctn
18 Compartments (L x W): A= 1-3/4" x 2-1/16" (4.45 x 5.24 cm)						

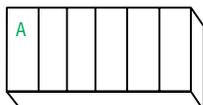
	A606D  T606D  K606D  M606D 	6658DB 6711DB 6658DK 6710DB	A-Series T-Series K-Series M-Series	Styrene TP SBC YP	10-1/2" x 6-3/16" x 2-1/4" (26.67 x 15.72 x 5.72 cm)	24/ctn
6 Compartments (L x W): A= 1-11/16" x 6-1/4" (4.29 x 15.88 cm)						

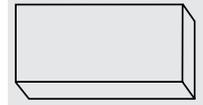
	A601D  K601D 	6652DB 6652DK	A-Series K-Series	Styrene SBC	10-1/2" x 6-3/16" x 2-1/4" (26.67 x 15.72 x 5.72 cm)	24/ctn
1 Compartment						

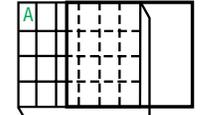
	A924-2	6684CB	A-Series	Styrene	10-9/16" x 8-1/4" x 1-9/16" (26.83 x 20.96 x 3.97 cm)	10/ctn
24 Compartments (L x W): A= 1-11/16" x 2" (4.29 x 5.08 cm), Box has Sliding Lid (Non-Hinged)						

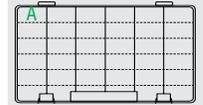
	T4007 	6747TE	Tuff Tainer	TP	10-5/8" x 6-5/8" x 1-9/16" (26.99 x 16.83 x 3.97 cm)	6/ctn
6 Compartments, Black Mechanical Latches (Ref. page 13) & 12 Removable Dividers (L x W): A= 1-11/16" x 6-1/4" (4.29 x 15.87 cm)						

	T4007AT	6748TE	Tuff Tainer	TP	10-5/8" x 6-5/8" x 1-9/16" (26.99 x 16.83 x 3.97 cm)	6/ctn
6 Compartments, Silver Mechanical Latches (Ref. pg 13) & 12 Removable Tarnish Inhibitor Dividers (Ref. pg 34) (L x W): A= 1-11/16" x 6-1/4" (4.29 x 15.87 cm)						

Boxes 10-5/8" x 6-5/8" x 1-9/16" through 11-15/16" x 5-15/16" x 1-7/16"
(26.99 x 16.83 x 3.97 cm) through (30.32 x 15.08 x 3.65 cm)

COMPARTMENTED BOXES

BOX MATERIAL KEY			SYMBOL KEY
TP = Translucent Polypropylene	YP = Yellow Polypropylene	TCP = Transparent Cellulose Propionate	◆ = Blue Diamond
SP = Taupe Polypropylene	WP = White Polypropylene	SBC = Styrene-Butadiene Copolymer	Ⓢ = Special Order
OP = Orange Polypropylene		SBMM = Styrene Butadiene Methyl Methacrylate	

Box Diagram	Model Number	Stock Number	Family	Material	Dimensions (Inside, L x W x D)	Packed
	T4007E ◆	6746TE	■ Tuff Tainer	TP	10-5/8" x 6-5/8" x 1-9/16" (26.99 x 16.83 x 3.97 cm)	6/ctn
6 Compartments, Integral Latches (Ref. page 13) & 12 Removable Dividers (L x W): A= 1-11/16" x 6-1/4" (4.29 x 15.87 cm)						
	T4000	6734TE	■ Tuff Tainer	TP	10-5/8" x 6-5/8" x 1-9/16" (26.99 x 16.83 x 3.97 cm)	6/ctn
	DB606	6758CD	■ Diamondback	Styrene	11" x 6-3/8" x 1-9/16" (27.94 x 16.19 x 3.97 cm)	12/ctn
6 Compartments (L x W): A= 1-3/4" x 6-3/8" (4.45 x 16.19 cm)						
	DB613 ◆	6764CD	■ Diamondback	Styrene	11" x 6-3/8" x 1-9/16" (27.94 x 16.19 x 3.97 cm)	12/ctn
13 Compartments (L x W): A= 1-7/8" x 2-1/16" (4.76 x 5.24 cm), B= 1-3/4" x 4-1/8" (4.45 x 10.48 cm), C= 3-9/16" x 4-1/8" (9.05 x 10.48 cm)						
	DB601 Ⓢ	6752CD	■ Diamondback	Styrene	11" x 6-3/8" x 1-9/16" (27.94 x 16.19 x 3.97 cm)	12/ctn
1 Compartment						
	DB618	6766CD	■ Diamondback	Styrene	11" x 6-3/8" x 1-9/16" (27.94 x 16.19 x 3.97 cm)	12/ctn
18 Compartments (L x W): A= 1-3/4" x 2-1/16" (4.45 x 5.24 cm)						
	5129-1	6789CH	■ Mighty-Tuff	TCP	11-15/16" x 5-15/16" x 1-7/16" (30.32 x 15.08 x 3.65 cm)	6/ctn
1 Compartment						
	5129CL	6226MT	■ Mighty-Tuff	TCP	11-15/16" x 5-15/16" x 1-7/16" (30.32 x 15.08 x 3.65 cm)	6/ctn
24 Compartments (L x W): A= 1-7/16" x 1-7/8" (3.65 x 4.76 cm)						
	5130CL	6228MT	■ Mighty-Tuff	TCP	11-15/16" x 5-15/16" x 1-7/16" (30.32 x 15.08 x 3.65 cm)	6/ctn
6 Compartments (L x W): A= 1-7/16" x 3-15/16" (3.65 x 10.00 cm), B= 8-7/8" x 1-7/8" (22.54 x 4.76 cm), C= 1-7/16" x 1-7/8" (3.65 x 4.76 cm), D= 10-3/8" x 1-7/8" (26.35 x 4.76 cm), E= 5-15/16" x 1-7/8" (15.08 x 4.76 cm)						

* Adding color to the resins effects the clarity of the finished product

COMPARTMENTED BOXES

Boxes 12-3/4" x 8-1/2" x 2-1/8" through 13-1/8" x 8-7/8" x 1-15/16"
(32.39 x 21.59 x 5.40 cm) through (33.34 x 22.54 x 4.92 cm)

BOX MATERIAL KEY					SYMBOL KEY	
TP = Translucent Polypropylene	YP = Yellow Polypropylene	TCP = Transparent Cellulose Propionate			◆ = Blue Diamond	
SP = Taupe Polypropylene	WP = White Polypropylene	SBC = Styrene-Butadiene Copolymer			Ⓢ = Special Order	
OP = Orange Polypropylene		SBMM = Styrene Butadiene Methyl Methacrylate				

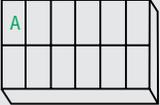
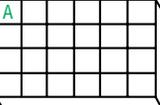
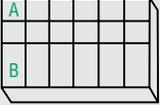
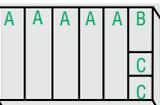
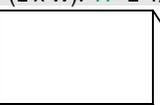
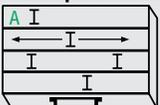
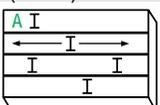
Box Diagram	Model Number	Stock Number	Family	Material	Dimensions (Inside, L x W x D)	Packed
 1 Compartment	A801 K801 ◆ C801	6672CB 6672KB 6734TC	■ A-Series ■ K-Series --	Styrene SBC Conductive	12-3/4" x 8-1/2" x 2-1/8" (32.39 x 21.59 x 5.40 cm)	12/ctn
 12 Compartments (L x W): A= 2-1/16" x 4-3/16" (5.24 x 12.22 cm)	A812 K812 M812	6676CB 6676KB 6722TF	■ A-Series ■ K-Series ■ M-Series	Styrene SBC YP	12-3/4" x 8-1/2" x 2-1/8" (32.39 x 21.59 x 5.40 cm)	12/ctn
 24 Compartments (L x W): A= 2-1/16" x 2-1/16" (5.24 x 5.24 cm)	A824 T824 ◆ K824 ◆ M824 C824	6680CB 6726TE 6680KB 6726TF 6726TC	■ A-Series ■ T-Series ■ K-Series ■ M-Series --	Styrene TP SBC YP Conductive	12-3/4" x 8-1/2" x 2-1/8" (32.39 x 21.59 x 5.40 cm)	12/ctn
 18 Compartments (L x W): A= 2-1/16" x 2-1/16" (5.24 x 5.24 cm), B= 2-1/16" x 4-3/16" (5.24 x 12.22 cm)	A818 Ⓢ K818 M818	6678CB 6678KB 6724TF	■ A-Series ■ K-Series ■ M-Series	Styrene SBC YP	12-3/4" x 8-1/2" x 2-1/8" (32.39 x 21.59 x 5.40 cm)	12/ctn
 6 Compartments (L x W): A= 2-1/16" x 8-1/2" (5.24 x 21.59 cm)	A806 Ⓢ T806 ◆ K806 M806	6674CB 6718TE 6674KB 6718TF	■ A-Series ■ T-Series ■ K-Series ■ M-Series	Styrene TP SBC YP	12-3/4" x 8-1/2" x 2-1/8" (32.39 x 21.59 x 5.40 cm)	12/ctn
 8 Compartments (L x W): A= 2-1/16" x 8-1/2" (5.24 x 21.59 cm), B= 2-1/16" x 4-1/8" (5.24 x 10.48 cm), C= 2-1/16" x 2" (5.24 x 5.08 cm)	M808 Ⓢ	6720TF	■ M-Series	YP	12-3/4" x 8-1/2" x 2-1/8" (32.39 x 21.59 x 5.40 cm)	12/ctn
 1 Compartment	T901 Ⓢ	6727ID	■ T-Series	TP	13-1/8" x 8-7/8" x 1-15/16" (33.34 x 22.54 x 4.92 cm)	6/ctn
 4 Compartments, with Handle & 16 IDS Dividers (Ref. page 13) (L x W): A= 13-1/8" x 2-1/8" (33.34 x 5.40 cm)	999-2	6726ID	■ IDS	TP	13-1/8" x 8-7/8" x 1-15/16" (33.34 x 22.54 x 4.92 cm)	6/ctn
 4 Compartments & 16 IDS Dividers (Ref. page 13) (L x W): A= 13-1/8" x 2-1/8" (33.34 x 5.40 cm)	T900 ◆	6725ID	■ IDS	TP	13-1/8" x 8-7/8" x 1-15/16" (33.34 x 22.54 x 4.92 cm)	6/ctn

* Adding color to the resins effects the clarity of the finished product

Boxes 13-1/2" x 5-3/4" x 2" through 17" x 7-1/8" x 2"
 (34.29 x 14.61 x 5.08 cm) through (43.18 x 18.10 x 5.08 cm)

COMPARTMENTED BOXES

BOX MATERIAL KEY			SYMBOL KEY
TP = Translucent Polypropylene	YP = Yellow Polypropylene	TCP = Transparent Cellulose Propionate	◆ = Blue Diamond
SP = Taupe Polypropylene	WP = White Polypropylene	SBC = Styrene-Butadiene Copolymer	Ⓢ = Special Order
OP = Orange Polypropylene		SBMM = Styrene Butadiene Methyl Methacrylate	

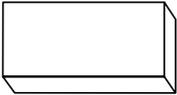
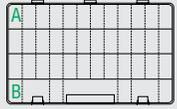
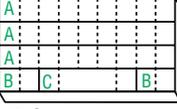
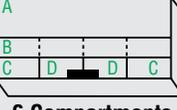
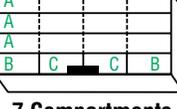
Box Diagram	Model Number	Stock Number	Family	Material	Dimensions (Inside, L x W x D)	Packed
 1 Compartment	V601 ◆	6667VB	V-Series	SP	13-1/2" x 5-3/4" x 2" (34.29 x 14.61 x 5.08 cm)	12/ctn
 4 Compartments, Black Mechanical Latches (Ref. page 13) & 20 Removable Dividers (L x W): A= 13-11/16" x 2" (34.77 x 5.08 cm), B= 13-11/16" x 1-11/16" (34.77 x 4.29 cm)	T5007 ◆	6757TE	Tuff Tainer	TP	13-11/16" x 8-3/16" x 1-3/4" (34.77 x 20.80 x 4.45 cm)	6/ctn
 4 Compartments, Silver Mechanical Latches (Ref. page 13) & 15 Removable Tarnish Inhibitor Dividers (Ref. page 34) (L x W): A= 13-11/16" x 2" (34.77 x 5.08 cm), B= 13-11/16" x 1-11/16" (34.77 x 4.29 cm)	T5007AT	6758TE	Tuff Tainer	TP	13-11/16" x 8-3/16" x 1-3/4" (34.77 x 20.80 x 4.45 cm)	6/ctn
 4 Compartments, Integral Latches (Ref. page 13) & 20 Removable Dividers (L x W): A= 13-11/16" x 2" (34.77 x 5.08 cm), B= 13-11/16" x 1-11/16" (34.77 x 4.29 cm)	T5007E ◆	6756TE	Tuff Tainer	TP	13-11/16" x 8-3/16" x 1-3/4" (34.77 x 20.80 x 4.45 cm)	6/ctn
 6 Compartments & 16 Removable Dividers (L x W): A= 15-5/16" x 2" (38.89 x 5.08 cm), B= 3-1/4" x 2" (8.26 x 5.08 cm), C= 8-1/2" x 2" (21.59 x 5.08 cm)	T6004 ◆	6760TE	Tuff Tainer	TP	15-1/4" x 8-7/8" x 1-3/8" (38.74 x 22.54 x 3.49 cm)	6/ctn
 6 Compartments & 9 Removable Dividers (L x W): A= 15-1/4" x 4-1/2" (38.74 x 11.43 cm), B= 15-1/4" x 2-1/8" (38.74 x 5.40 cm), C= 3-3/4" x 2-1/8" (9.53 x 5.40 cm), D= 3-3/4" x 1-1/2" (9.53 x 3.81 cm)	T7003/4	6773TE	Tuff Tainer	TP	15-1/4" x 8-7/8" x 3" (38.74 x 22.54 x 7.62 cm)	6/ctn
 7 Compartments & 9 Removable Dividers (L x W): A= 15-1/4" x 2-3/16" (38.74 x 5.56 cm), B= 3-3/4" x 2-1/8" (9.52 x 5.40 cm), C= 3-3/4" x 2-1/8" (9.52 x 5.40 cm)	T7004 ◆	6774TE	Tuff Tainer	TP	15-1/4" x 8-7/8" x 3" (38.74 x 22.54 x 7.62 cm)	6/ctn
 1 Compartment	T7000 ◆	6770TE	Tuff Tainer	TP	15-1/4" x 8-7/8" x 3" (38.74 x 22.54 x 7.62 cm)	6/ctn
 1 Compartment	V701 ◆	6172VB	V-Series	SP	17" x 7-1/8" x 2" (43.18 x 18.10 x 5.08 cm)	6/ctn

* Adding color to the resins effects the clarity of the finished product

COMPARTMENTED BOXES

Deep & Slim Super Satchels

The Super Satchel has a proven record when it comes to accommodating parts. Used in many industries as a kit for replacement parts or as a salesperson's sidekick, you won't need to worry about being organized. All Super Satchels are made out of "Acid Free" translucent polypropylene, with a positive contact latch system. The Deep Super Satchels are available in one compartment, six fixed compartments or six fixed compartments with removable dividers. The Slim Super Satchels are available in one compartment or eight fixed compartments and can accommodate up to 40 removable dividers.

The Deep Super Satchel Boxes are stackable and made from "Acid Free" Polypropylene with black handle and positive contact latches.

- **T9001 Deep Super Satchel**
- Accommodates 12" x 12" (30.48 x 30.48 cm) documents
- **T9006 Deep Super Satchel**
- 6 fixed extra deep compts
- **T9007 Deep Super Satchel**
- 6 fixed extra deep compts with 12 removable dividers included
- Divider packs sold separately (**See page 34**)

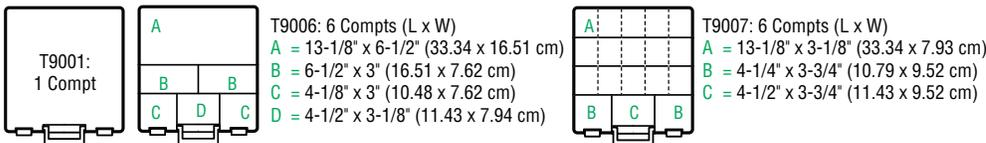

Model Number	Stock Number	Description inch (centimeter)	Dimensions (Inside, L x W x D)	Packed
T9001	6991TE	1 compt w/black handle & latches Outside Dimensions: 14 x 15 x 3-1/2 (35.56 x 38.10 x 8.89)	13-1/8" x 13-1/8" x 3" (33.34 x 33.34 x 7.62 cm)	6/ctn
T9006	6996TE	6 compt w/black handle & latches Outside Dimensions: 14 x 15 x 3-1/2 (35.56 x 38.10 x 8.89)	13-1/8" x 13-1/8" x 3" (33.34 x 33.34 x 7.62 cm)	6/ctn
T9007	6997TE	6 compt w/black handle & latches & 12 removable dividers Outside Dimensions: 14 x 15 x 3-1/2 (35.56 x 38.10 x 8.89)	13-1/8" x 13-1/8" x 3" (33.34 x 33.34 x 7.62 cm)	6/ctn

The Slim Super Satchel Boxes are stackable and made from "Acid Free" Polypropylene with black (T9100 & T9101) or silver (T9101AT) positive contact latches.

- **T9100 Slim Super Satchel**
- Accommodates 12" x 12" (30.48 x 30.48 cm) documents
- **T9101 / T9101AT Slim Super Satchels**
- 8 fixed compts with 20 removable dividers included
- T9101AT includes the Tarnish Inhibitor dividers (**See page 34**)
- Accommodates up to 40 dividers for up to 48 compts
- Divider 12-packs sold separately (**See page 34**)

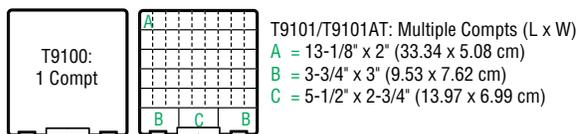

Model Number	Stock Number	Description inch (centimeter)	Dimensions (Inside, L x W x D)	Packed
T9100	6990TE	1 compt w/black latches Outside Dimensions: 14 x 15 x 2 (35.56 x 38.10 x 5.08)	13-1/8" x 13-1/8" x 1-3/4" (33.34 x 33.34 x 4.45 cm)	6/ctn
T9101	6998TE	8 compt w/black latches, & 20 removable dividers Outside Dimensions: 14 x 15 x 2 (35.56 x 38.10 x 5.08)	13-1/8" x 13-1/8" x 1-3/4" (33.34 x 33.34 x 4.45 cm)	6/ctn
T9101AT	6999TE	8 compt w/silver latches, & 20 removable Tarnish Inhibitor dividers Outside Dimensions: 14 x 15 x 2 (35.56 x 38.10 x 5.08)	13-1/8" x 13-1/8" x 1-3/4" (33.34 x 33.34 x 4.45 cm)	6/ctn

COMPARTMENTED BOXES

Deluxe & Double Deep Super Satchels

Like the Deep and Slim Super Satchels, the Deluxe and Double Deep Super Satchels are made out of “Acid Free” translucent polypropylene, with a positive contact latch system.

Deluxe Super Satchel™ Boxes

The Deluxe Super Satchel is the “Ultimate Storage Unit” - essentially four boxes in one - and is available in three different configurations: Open Top / Divided Bottom, Divided Top / Open Bottom, and Divided Top / Divided Bottom. The divided sections of the Deluxe Super Satchel include removable dividers.

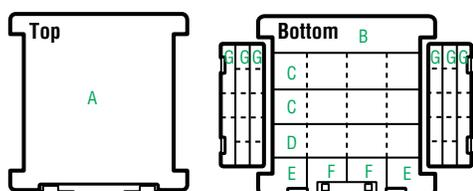

T9500 Compartments Dimensions (L x W)
A = 13-1/4" x 15-1/8" (33.66 x 38.42 cm)
B = 13-1/2" x 3-1/8" (34.29 x 7.94 cm)
C = [2 rows of 4 compts] 2-7/8" x 3-1/8" (7.30 x 7.94 cm)
D = [1 row of 4 compts] 2-7/8" x 3-1/4" (7.30 x 8.26 cm)
E = [2 compts] 3" x 2-1/2" (7.62 x 6.35 cm)
F = [2 compts] 2-1/4" x 3-5/8" (5.72 x 9.21 cm)
G = [3 rows 15 compts on each side] 2-1/4" x 1-1/8" (5.71 x 2.86 cm)

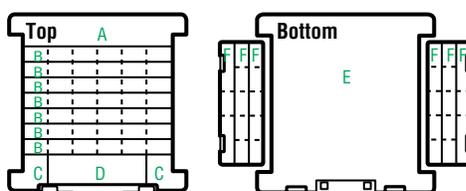

T9501 Compartments (L x W)
A = 13-1/4" x 2-3/4" (33.66 x 6.99 cm)
B = [7 rows 42 compts] 13-1/4" x 1-1/4" (33.66 x 3.18 cm)
C = [2 compts] 2" x 2-5/8" (5.08 x 6.67 cm)
D = [1 compt] 9" x 2-3/4" (22.86 x 6.99 cm)
E = 13-1/4" x 15-1/2" (33.66 x 38.74 cm)
F = [3 rows 15 compts on each side] 2-1/4" x 1-1/8" (5.71 x 2.86 cm)

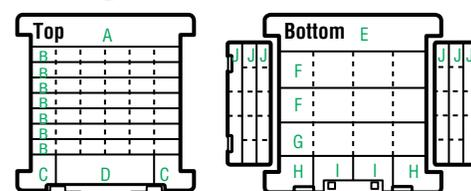

T9502 Compartments (L x W)
A = 13-1/4" x 2-3/4" (33.66 x 6.99 cm)
B = 13-1/4" x 1-1/4" (33.66 x 3.18 cm)
C = 2" x 2-5/8" (5.08 x 6.67 cm)
D = 9" x 2-3/4" (22.86 x 6.99 cm)
E = 13-1/2" x 3-1/8" (34.29 x 7.94 cm)
F = [2 rows of 4 compts] 2-7/8" x 3-1/8" (7.30 x 7.94 cm)
G = [1 row of 4 compts] 2-7/8" x 3-1/4" (7.30 x 8.26 cm)
H = [2 compts] 3" x 2-1/2" (7.62 x 6.35 cm)
I = [2 compts] 2-1/4" x 3-5/8" (5.72 x 9.21 cm)
J = [3 rows 15 compts on each side] 2-1/4" x 1-1/8" (5.71 x 2.86 cm)

Model Number	Stock Number	Description	Dimensions (Outside, L x W x D)	Packed
T9500	6787TE	Color: Translucent with Black Handle & Latches Open Top & Divided Bottom. Includes removable dividers.	17-1/4" x 16-3/4" x 5" (43.82 x 42.55 x 12.70 cm)	3/ctn
T9501	6788TE	Color: Translucent with Black Handle & Latches Divided Top & Open Bottom. Includes removable dividers.	17-1/4" x 16-3/4" x 5" (43.82 x 42.55 x 12.70 cm)	3/ctn
T9502	6789TE	Color: Translucent with Black Handle & Latches Divided Top & Divided Bottom. Includes removable dividers.	17-1/4" x 16-3/4" x 5" (43.82 x 42.55 x 12.70 cm)	3/ctn

Double Deep Super Satchel™

The Double Deep Super Satchel has extra depth for tall items and can be used one of two ways: Open Core (without dividers) or customized to up to eight compartments using removable dividers.

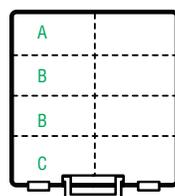

T9200 Compartments (L x W)
w/o Dividers = 12-7/16" x 12-9/16" (31.57 x 31.93 cm)
A = [1 row 2 compts] 6-1/4" x 3" (15.88 x 7.62 cm)
B = [2 rows 4 compts] 6-1/4" x 3-1/4" (15.88 x 8.26 cm)
C = [1 row 2 compts] 6-1/4" x 2-3/4" (15.88 x 6.99 cm)



Model Number	Stock Number	Description	Dimensions (Outside, L x W x D)	Packed
T9200	6784TE	Color: Translucent with Black Handle & Latches Double Deep. Includes removable dividers.	15-7/32" x 14-5/32" x 6-7/32" (38.66 x 35.96 x 15.80 cm)	3/ctn

COMPARTMENTED BOXES

Compartmented Box / Super Satchel Case Divider Packs



Tarnish Inhibitor by Flambeau provides safe, long-term protective storage for sterling silver items. The patented Tarnish Inhibitor additive forms a harmless protective layer around silver surfaces that prevents tarnishing for up to five years.

To order Tarnish Inhibitor dividers for your specific Tuff Tainer or Super Satchel, see below:

T4007AT	(page 28)	12/pack	Order#	4812DP
T5007AT	(page 31)	12/pack	Order#	5812DP
T9101AT	(page 32)	12/pack	Order #	5812DP



Zerust®, a new advanced polymer technology that creates a harmless vapor barrier around your parts inhibiting corrosion for up to five years, is now an option available in Tuff Tainer dividers.

To order Zerust dividers for your specific Tuff Tainer or Super Satchel, see below:

T2003	(page 22)	15/pack	Order#	2012ZP
T3003	(page 26)	12/pack	Order #	3012ZP
T4007	(page 28)	12/pack	Order #	4712ZP
T5007	(page 31)	12/pack	Order #	5712ZP
T6004	(page 31)	12/pack	Order #	6012ZP
T7003	(page 31)	12/pack	Order #	7012ZP
T7004	(page 31)	12/pack	Order #	7012ZP
T9101	(page 32)	12/pack	Order #	5712ZP
T9007	(page 32)	12/pack	Order #	9012ZP



Zerust is a registered trademark of Northern Technologies International Corporation.

To order Non-Zerust dividers for your specific Tuff Tainer or Super Satchel, see below:

T1002	(page 20)	12/pack	Order #	1012DP	Order Bulk #	601331
T2003	(page 22)	15/pack	Order #	2012DP	Order Bulk #	601321
T3003	(page 26)	12/pack	Order #	3412DP	Order Bulk #	601320
T4007	(page 28)	12/pack	Order #	4712DP	Order Bulk #	601370
T5007	(page 31)	12/pack	Order #	5712DP	Order Bulk #	601365
T6004	(page 31)	12/pack	Order #	6012DP	Order Bulk #	601329
T7003	(page 31)	12/pack	Order #	7012DP	Order Bulk #	601332
T7004	(page 31)	12/pack	Order #	7012DP	Order Bulk #	601332
T9101	(page 32)	12/pack	Order #	5712DP	Order Bulk #	601365
T9007	(page 32)	12/pack	Order #	9012DP	Order Bulk #	601372



To order IDS (Infinite Divider System) dividers, see below:

T300	(page 22)	8/pack	Order #	3108DP	Order Bulk #	601316
T600	(page 27)	8/pack	Order #	6108DP	Order Bulk #	601308
T900	(page 30)	8/pack	Order #	9108DP	Order Bulk #	601310



Compartment ribbed at 1/16" (0.16 cm) increments.
US Patent 4,838,445

CASES: TRADESMAN & MERCHANT X STYLES

Tradesman™ Case

The original! Any other case resembling this style is a knock-off! Flambeau Tradesman Cases are built in the USA! These professional hand-held carrying cases are very functional. Commonly used to protect; store; and attractively merchandise hundreds of products. Tradesman cases are easy to customize with different color options; adhesive or in-mold labels; logo plates; interior foam sets; vacuum trays or just “plain open!” Made from tough polypropylene resin, the Tradesman Series cases incorporate slide open/shut lockable latches with overlapping lid to base closure providing natural dust barrier and moisture resistance. Available in three sizes (10”, 14” and 17”) with more new sizes coming soon!



Customization of the Tradesman™ Case

Customize your Tradesman case with options that include engraving, printing, labeling, die-cut foam and the in-mold labeling process which is nearly indestructible and impervious to chemicals.



Custom Foam:
Convuluted, or
Diced Available.

Tradesman case stock colors include Black, and Translucent Clear. Custom colors are available. Please call Customer Service at 1-800-344-5716 for stock and custom colors.

Custom Options Enhance Interest

Point-of-Purchase has become more important than ever before as companies look for ways to reduce cost and improve sales. Using the Flambeau Tradesman™, options such as in-mold decorating, labeling, engraving, & custom foam interiors enhance consumer interest.



Merchant X Case

NEW

Merchant X is the next generation styled case beyond Tradesman. The Merchant Case design is truly innovative! U S Design Patent D633,294 granted March 1, 2011. All Merchant X Cases employ shallow lid with deep base functionality. The deep base allows greater capacity for storage and less cost when lid foam is required. The Merchant X10 and Merchant X15 case handles are designed to provide excellent balance by off-setting the handle for center



grasp between the lid and base. Slide open/shut lockable latches with a bead-line seal fit complete this exquisite line. Available in 7, 10, 12, and 15 inch size ranges!!

Custom Foam

Merchant cases offer the best solution when foam is the desired choice for protecting and merchandising your products. The shallow lid design in all Merchants minimizes the required use of foam there by minimizing cost. The Merchant's deep base versus Tradesman style cases is excellent for storing multiple contoured parts.



NEW

Introducing the
7" Merchant X



CASES: TRADESMAN & MERCHANT X

Flambeau Tradesman™ Cases

- All are available in black, translucent clear and blue
- Black case is available with or without foam



Model Number	Stock Number	Description	Dimensions (Inside, L x W x D)	Packed
6775TC	6775TC	10-1/2" (26.67 cm) Black - without Foam	9-1/2" x 5-3/4" x 2-3/4" (24.13 x 14.61 x 6.99 cm)	14/ctn
6775TB	6775TB	10-1/2" (26.67 cm) Black - without Foam - Biodegradable		
6776TC	6776TC	10-1/2" (26.67 cm) Black - with Convuluted Foam		
6775WF	6775WF	10-1/2" (26.67 cm) Black - with Convuluted Foam Lid & Diced Foam Base		
6775TF	6775TF	10-1/2" (26.67 cm) Translucent Clear		
6775TD	6775TD	10-1/2" (26.67 cm) Translucent Blue		
6780TC	6780TC	14" (35.56 cm) Black - without Foam	13-1/4" x 7-3/8" x 3" (33.66 x 18.73 x 7.62 cm)	14/ctn
6780TB	6780TB	14" (35.56 cm) Black - without Foam - Biodegradable		
6781TC	6781TC	14" (35.56 cm) Black - with Convuluted Foam		
6780XG	6780XG	14" (35.56 cm) Black - with Convuluted Foam Lid & Diced Foam Base		
6780TN	6780TN	14" (35.56 cm) Translucent Clear		
6780TP	6780TP	14" (35.56 cm) Translucent Blue		
6785TC	6785TC	17" (43.18 cm) Black - without Foam	16-3/8" x 9-1/4" x 3-1/2" (41.59 x 23.50 x 8.89 cm)	6/ctn
6785TB	6785TB	17" (43.18 cm) Black - without Foam - Biodegradable		
6785TE	6785TE	17" (43.18 cm) Black - with Convuluted Foam		
6785UP	6785UP	17" (43.18 cm) Black - with Convuluted Foam Lid & Diced Foam Base		
6785TI	6785TI	17" (43.18 cm) Translucent Clear		

Merchant X Cases

An Xcellent complement to our Tradesman Case Line

- The Merchant X cases feature integral handle, mechanical hinge and lockable sliding latches
- Designed with deep base/shallow lid for greater storage area



Model Number	Stock Number	Description	Dimensions (Inside, L x W x D)	Packed
6767TC	6767TC	7" (17.78 cm) Black - without Foam	6-1/2" x 4-1/5" x 3-1/5" (16.51 x 10.67 x 8.13 cm)	12/ctn
6767TN	6767TN	7" (17.78 cm) Translucent Clear - without Foam		
6772TC	6772TC	10" (25.4 cm) Black - without Foam	9-5/8" x 7-1/8" x 2-4/5" (24.45 x 18.10 x 7.11 cm)	12/ctn
6772TB	6772TB	10" (25.4 cm) Black - without Foam - Biodegradable		
6772TF	6772TF	10" (25.4 cm) Black - with Flat Foam Lid and Convuluted Base		
6772TD	6772TD	10" (25.4 cm) Translucent Clear - without Foam		
6777TC	6777TC	12" (30.48 cm) Black - without Foam	11" x 7-1/4" x 3-1/4" (27.94 x 18.41 x 8.25 cm)	12/ctn
6777TB	6777TB	12" (30.48 cm) Black - without Foam - Biodegradable		
6777TF	6777TF	12" (30.48 cm) Black - with Flat Foam Lid & Diced Foam Base		
6777TD	6777TD	12" (30.48 cm) Translucent Clear - without Foam		
6782TC	6782TC	15" (38.1 cm) Black - without Foam	14" x 11" x 3-1/8" (35.56 x 27.94 x 7.94 cm)	12/ctn
6783TC	6783TC	15" (38.1 cm) Black - with Divided Base & 12 Dividers		
6786TC	6786TC	15" (38.1 cm) Black - with Tray, Divided Base & 16 Dividers		



The Defender...Just in Case!

The combination of high-density homopolymer material and double-wall construction offer increased product protection. This case is water- and chemical-resistant. Can be customized through logo engraving, Spectra-Molding™ permanent labeling, custom colors, foam or molded interior.

- ProTech™ Latches
- Rear Feet Detail (Offers increased stability for upright display)
- Exterior Banding Strap Detail (Allows case to be used as a shipping container)
- Interior Gasket Seal
- Water- and Chemical-resistant
- Crush-resistant and Stackable

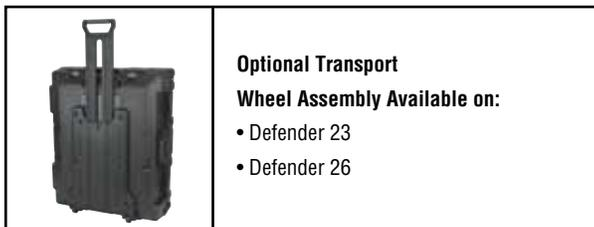
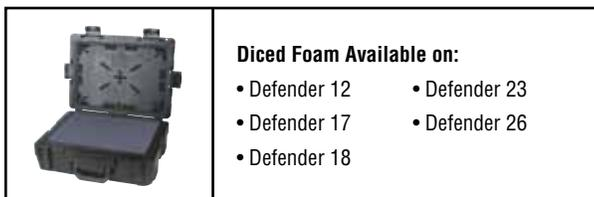

Model Number	Stock Number	Description	Inside Dimensions (L x W x D) inches (cm)	Outside Dimensions (L x W x D) inches (cm)
Defender 12 (DQ 6)	50641	Defender 12	12 x 9 x 5 (30.48 x 22.86 x 12.70)	15-15/16 x 13-1/4 x 6-7/16 (40.48 x 33.65 x 16.35)
Defender 12 (DQ 6)	50641F	Defender 12 with Diced Foam	12 x 9 x 5 (30.48 x 22.86 x 12.70)	15-15/16 x 13-1/4 x 6-7/16 (40.48 x 33.65 x 16.35)
Defender 17 (DW 6)	50514	Defender 17	15 x 12 x 5 (38.10 x 30.48 x 12.70)	18-1/2 x 15 x 6-3/16 (21.59 x 38.10 x 15.72)
Defender 17 (DW 6)	50514F	Defender 17 with Diced Foam	15 x 12 x 5 (38.10 x 30.48 x 12.70)	18-1/2 x 15 x 6-3/16 (21.59 x 38.10 x 15.72)
Defender 18 (DX 7)	50642	Defender 18	15-1/2 x 10-1/4 x 6 (39.37 x 26.03 x 15.24)	20-3/4 x 15-3/4 x 7-5/16 (52.70 x 40.00 x 18.57)
Defender 18 (DX 7)	50642F	Defender 18 with Diced Foam	15-1/2 x 10-1/4 x 6 (39.37 x 26.03 x 15.24)	20-3/4 x 15-3/4 x 7-5/16 (52.70 x 40.00 x 18.57)
Defender 23 (DY 9)	50720	Defender 23	19-1/2 x 15 x 7-3/4 (49.53 x 38.10 x 19.68)	25-1/4 x 21 x 9-3/16 (64.13 x 53.34 x 23.34)
Defender 23 (DY 9)	50720F	Defender 23 with Diced Foam	19-1/2 x 15 x 7-3/4 (49.53 x 38.10 x 19.68)	25-1/4 x 21 x 9-3/16 (64.13 x 53.34 x 23.34)
Defender 23 (DY 9)	50720W	Defender 23 with Wheel Assembly	19-1/2 x 15 x 7-3/4 (49.53 x 38.10 x 19.68)	25-1/4 x 21 x 9-3/16 (64.13 x 53.34 x 23.34)
Defender 23 (DY 9)	50720FW	Defender 23 with Diced Foam and Wheel Assembly	19-1/2 x 15 x 7-3/4 (49.53 x 38.10 x 19.68)	25-1/4 x 21 x 9-3/16 (64.13 x 53.34 x 23.34)
Defender 26 (DZ 9)	50721	Defender 26	22-3/4 x 17-3/4 x 8 (57.78 x 44.04 x 20.32)	28-3/4 x 24 x 9-5/16 (73.02 x 60.96 x 23.65)
Defender 26 (DZ 9)	50721F	Defender 26 with Diced Foam	22-3/4 x 17-3/4 x 8 (57.78 x 44.04 x 20.32)	28-3/4 x 24 x 9-5/16 (73.02 x 60.96 x 23.65)
Defender 26 (DZ 9)	50721W	Defender 26 with Wheel Assembly	22-3/4 x 17-3/4 x 8 (57.78 x 44.04 x 20.32)	28-3/4 x 24 x 9-5/16 (73.02 x 60.96 x 23.65)
Defender 26 (DZ 9)	50721WF	Defender 26 with Diced Foam and Wheel Assembly	22-3/4 x 17-3/4 x 8 (57.78 x 44.04 x 20.32)	28-3/4 x 24 x 9-5/16 (73.02 x 60.96 x 23.65)

CASES: INFINITY™

Infinity™ Case



With flair, style and professional presence, the Infinity is designed to give you a high level of protection with a modern look.



Empty

Convoluted & Flat

Convoluted & Diced

Offered with or without foam, the Infinity is available in a variety of sizes and depths.



The Infinity lends itself to customization including engraving, printing, labeling, die-cut foam, custom colors and the in-mold labeling/decorating process (see pages 8 & 9). Made of high-density polyethylene (HDPE) the case is impervious to most chemicals, gasoline & is an excellent case for most applications.



The Infinity features a natural dust seal and double wall protection in the lid and base that naturally creates an interior impact barrier helping the case become crush resistant and withstand a 30 pound impact test. The dual latch system provides easy latching with confidence of security even in the harshest conditions.



Infinity Pin Hinge



Infinity Locking Hole

Some Size Samples of Infinity Cases



NEW



Infinity 14 (FV 6.5)
50380

Infinity™ Cases

This blow molded case with double wall construction gives you the highest protection level possible.

- Offered with or without foam
- Select styles available in integral or pin hinge

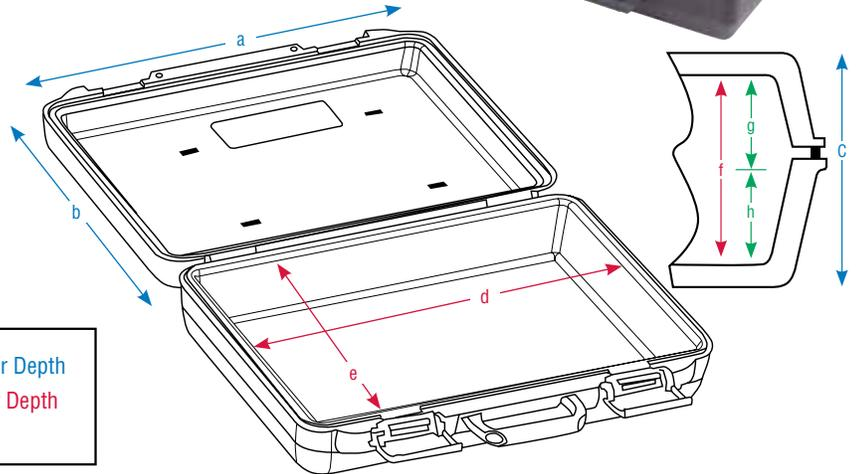

Drawing Key

a = Exterior Length b = Exterior Width c = Overall Exterior Depth
 d = Interior Length e = Interior Width f = Overall Interior Depth
 g = Interior Lid Depth h = Interior Base Depth

Stock Number	Style	Interior Dimensions: L x W x overall D (d x e x f) inches (cm)	Interior Depth: Lid = g Base = h inches (cm)	Exterior Dimensions: L x W x overall D (a x b x c) inches (cm)	Standard Handle / Latch	Description
20190 50190	Infinity 10 FH 4	8-1/4 x 5-7/16 x 3-5/16 (20.96 x 13.81 x 8.41)	g = 1-5/16 (3.33) h = 1-15/16 (4.92)	10-1/8 x 8-1/8 x 4 (25.72 x 20.64 x 10.16)	H052 / L089	foam option available
20250 50250	Infinity 12 FQ 2-1/2	9-1/2 x 6-5/8 x 1-3/4 (24.13 x 16.83 x 4.45)	g = 3/8 (0.95) h = 1-3/8 (3.49)	12 x 9 x 2-1/2 (30.48 x 22.86 x 6.35)	none / L089	foam option available
20290 50290	Infinity 12 FQ 4-1/2	9-1/2 x 6-5/8 x 3-3/16 (24.13 x 16.83 x 8.10)	g = 2-7/16 (6.19) h = 2-3/8 (6.03)	12 x 9 x 4-1/2 (30.48 x 22.86 x 11.43)	H052 / L089	foam option available
20330 50330	Infinity 14 FV 4	11-1/2 x 8-1/2 x 3-3/16 (29.21 x 21.59 x 8.10)	g = 1-3/8 (3.49) h = 1-13/16 (4.60)	14 x 10-1/2 x 4 (35.56 x 26.67 x 10.16)	H052 / L089	foam option available
20350 50350	Infinity 14 FV 5	11-1/2 x 8-1/2 x 4-1/4 (29.21 x 21.59 x 10.80)	g = 1-7/8 (4.76) h = 2-3/8 (6.03)	14 x 10-1/2 x 5 (35.56 x 26.67 x 12.70)	H052 / L089	Integral Hinge foam option available
20351 50351	Infinity 14 FV 5	11-1/2 x 8-1/2 x 4-1/4 (29.21 x 21.59 x 10.80)	g = 1-7/8 (4.76) h = 2-3/8 (6.03)	14 x 10-1/2 x 5 (35.56 x 26.67 x 12.70)	H052 / L089	Pin Hinge foam option available
NEW 20380 50380	Infinity 14 FV 6-1/2	11 x 7-11/16 x 5-3/4 (27.94 x 19.53 x 14.61)	g = 2-1/8 (5.41) h = 3-1/2 (8.90)	14 x 11 x 7 (35.6 x 28 x 17.8)	H0230M / L089	foam option available
20410 50410	Infinity 17 FW 4-1/2	14-3/8 x 10 x 3-7/16 (36.51 x 25.40 x 8.73)	g = 1-1/4 (3.18) h = 2-3/16 (5.56)	17 x 14-1/2 x 4-1/2 (43.18 x 36.83 x 11.43)	H0230M / L085	foam option available
20430 50430	Infinity 17 FW 6-1/2	14-3/8 x 10 x 5-9/16 (36.51 x 25.40 x 14.13)	g = 2-5/16 (5.87) h = 3-1/4 (8.26)	17 x 14-1/2 x 6-1/2 (43.18 x 36.83 x 16.51)	H0230M / L085	foam option available
20470 50470	Infinity 20 FX 5-1/2	17-3/4 x 12-5/8 x 4-1/16 (45.09 x 32.07 x 11.75)	g = 1-13/16 (4.60) h = 2-1/4 (5.72)	20 x 15 x 5-1/2 (50.80 x 38.10 x 13.97)	H0230M / L095	foam option available
20500 50500	Infinity 20 FX 8-1/2	17-3/4 x 12-5/8 x 7-1/2 (45.09 x 32.07 x 19.05)	g = 3-1/4 (8.26) h = 4-1/4 (10.80)	20 x 15 x 8-1/2 (50.80 x 38.10 x 21.59)	H0230M / L095	foam option available
50817	Infinity 27 FZ 8-1/2	24-15/16 x 14-3/16 x 7-1/2 (63.33 x 36.03 x 19.05)	g = 1-1/2 (3.81) h = 6 (15.24)	27-3/8 x 18 x 8-1/2 (69.53 x 45.72 x 21.59)	H074 / L115	foam option available
50845	Infinity 43 FZ 7	40-5/8 x 14-7/16 x 6 (103.18 x 36.67 x 15.24)	g = 1-1/2 (3.81) h = 4-1/2 (11.43)	43 x 18-15/16 x 7 (109.22 x 46.51 x 17.78)	H074 / L116	foam option available

CASES: "P" SERIES

"P" Series - Pin Hinge Case



The "P" Series case is a Flambeau original and has a proven track record in most industries and applications.

This pin-hinge style high-density polyethylene (HDPE) blow molded case features heavy-duty latches, double-wall lid protection and is impervious to most chemicals and gasoline.



The routed base option is designed to accommodate our standard solid sheet or diced foam and is available in a variety of sizes and depths. Please call Customer Service for size availability.



The "P" Series is easily customized through engraving, printing, labeling, custom colors, die-cut foam, molded interiors and in-mold decorating/labeling process (molded into the case) which is nearly indestructible.

Drawing Key

- a = Exterior Length
- b = Exterior Width
- c = Overall Exterior Depth
- d = Interior Length
- e = Interior Width
- f = Overall Interior Depth
- g = Interior Lid Depth
- h = Interior Base Depth
- i = Routed Depth

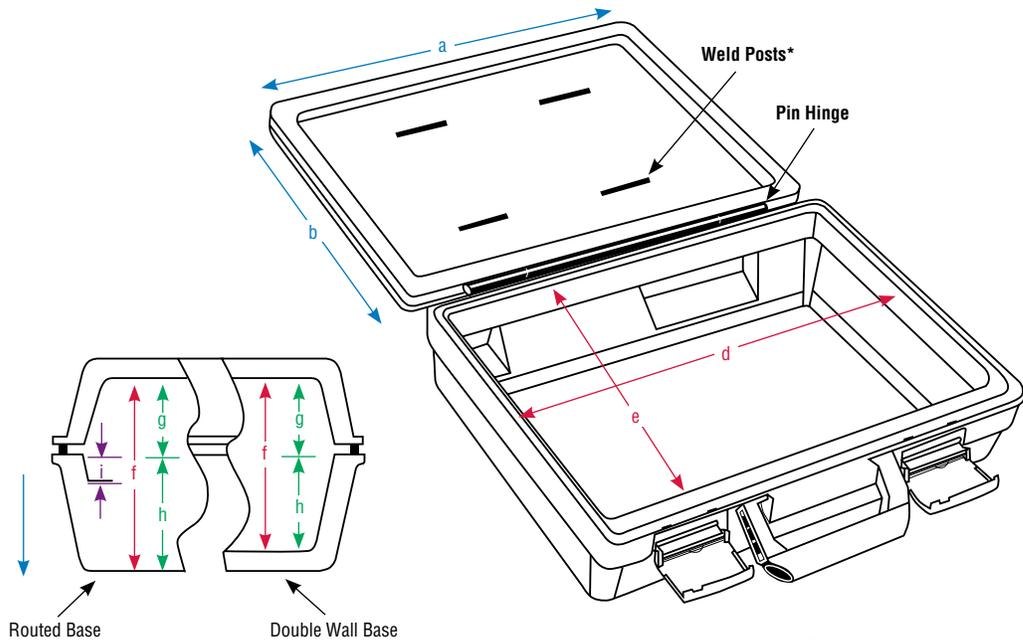

* Number of weld posts may vary.

Stock Number	Style	Interior Dimensions: L x W x overall D (d x e x f) inches (cm)	Routed Depth = i inches (cm)	Interior Depth: Lid = g Base = h inches (cm)	Exterior Dimensions: L x W x overall D (a x b x c) inches (cm)	Standard Handle / Latch	Comments inches (cm)
18673	PB 1-5/8	6-13/16 x 3-3/16 x 1-5/16 (17.30 x 8.10 x 3.33)	1/4 (0.64)	g = 1/8 (0.32) h = 1-3/16 (3.02)	7-1/2 x 4-1/2 x 1-5/8 (19.05 x 11.43 x 4.13)	none / L089	foam option available
17873	PC 3-1/8	7-1/4 x 5-7/8 x 2-13/16 (18.42 x 14.92 x 7.14)	7/16 (1.11)	g = 5/8 (1.59) h = 2-3/16 (5.56)	8-1/2 x 7-13/16 x 3-1/8 (21.59 x 19.84 x 7.94)	H001 / L089	foam option available

"P" Series Cases Continued on page 41

CASES: "P" SERIES

Stock Number	Style	Interior Dimensions: L x W x overall D (d x e x f) inches (cm)	Routed Depth = i inches (cm)	Interior Depth: Lid = g Base = h inches (cm)	Exterior Dimensions: L x W x overall D (a x b x c) inches (cm)	Standard Handle / Latch	Comments inches (cm)
16887 50032	PC 3-9/16	7-1/4 x 5-7/8 x 3-1/4 (18.42 x 14.92 x 8.26)	7/16 (1.11)	g = 5/8 (1.59) h = 2-5/8 (6.67)	8-1/2 x 7-13/16 x 3-9/16 (21.59 x 19.84 x 9.05)	H001 / L089	4-7/8 x 1-7/8 (12.38 x 4.76) label recess, foam opt. avl.
15865	PC 3-9/16	7-1/4 x 5-7/8 x 3-1/4 (18.42 x 14.92 x 8.26)	7/16 (1.11)	g = 5/8 (1.59) h = 2-5/8 (6.67)	8-1/2 x 7-13/16 x 3-9/16 (21.59 x 19.84 x 9.05)	H001 / L089	3-1/4 x 1-1/2 (8.26 x 3.81) label recess
16070	PF 1-3/4	8-5/8 x 4 x 1-7/16 (21.91 x 10.16 x 3.65)	7/16 (1.11)	g = 5/8 (1.59) h = 13/16 (2.06)	9-1/2 x 5-3/4 x 1-3/4 (24.13 x 14.61 x 4.45)	none / L089	
16716	PF 3-1/8	8-5/8 x 4 x 2-13/16 (21.91 x 10.16 x 7.14)	7/16 (1.11)	g = 5/8 (1.59) h = 3-3/16 (8.10)	9-1/2 x 5-3/4 x 3-1/8 (24.13 x 14.61 x 7.94)	H001 / L089	
17474 50048	PH 3-1/8	9-1/8 x 6-1/2 x 2-13/16 (23.18 x 16.51 x 7.14)	7/16 (1.11)	g = 5/8 (1.59) h = 2-3/16 (5.56)	10 x 8-5/16 x 3-1/8 (25.40 x 21.11 x 7.94)	H001 / L089	foam option available
18964	PH 3-7/16	9-1/8 x 6-1/2 x 3-1/8 (23.18 x 16.51 x 7.94)	7/16 (1.11)	g = 15/16 (2.38) h = 2-3/16 (5.56)	10 x 8-5/16 x 3-7/16 (25.40 x 21.11 x 8.73)	H001 / L089	
17383	PH 3-9/16	9-1/8 x 6-1/2 x 3-1/4 (23.18 x 16.51 x 8.26)	7/16 (1.11)	g = 5/8 (1.59) h = 2-5/8 (6.67)	10 x 8-5/16 x 3-9/16 (25.40 x 21.11 x 9.05)	H001 / L089	
18290	PH 3-7/8	9-1/8 x 6-1/2 x 3-9/16 (23.18 x 16.51 x 9.05)	7/16 (1.11)	g = 15/16 (2.38) h = 2-5/8 (6.67)	10 x 8-5/16 x 3-7/8 (25.40 x 21.11 x 9.84)	H001 / L089	
16615	PQ 2-3/8	11-3/8 x 7 x 2-1/16 (28.89 x 17.78 x 5.24)	7/16 (1.11)	g = 15/16 (2.38) h = 1-1/8 (2.86)	12-1/4 x 8-13/16 x 2-3/8 (31.12 x 22.38 x 6.03)	none / L089	
18924	PQ 3-7/16	11-3/8 x 7 x 3-1/8 (28.89 x 17.78 x 7.94)	7/16 (1.11)	g = 15/16 (2.38) h = 2-3/16 (5.56)	12-1/4 x 8-13/16 x 3-7/16 (31.12 x 22.38 x 8.73)	H052 / L089	
12349	PQ 3-13/16	11-3/8 x 7 x 3-7/16 (28.89 x 17.78 x 8.73)	7/16 (1.11)	g = 1-1/4 (3.18) h = 2-3/16 (5.56)	12-1/4 x 8-13/16 x 3-13/16 (31.12 x 22.38 x 9.68)	H052 / L089	
12347 50025	PQ 3-7/8	11-3/8 x 7 x 3-9/16 (28.89 x 17.78 x 9.05)	7/16 (1.11)	g = 15/16 (2.38) h = 2-5/8 (6.67)	12-1/4 x 8-13/16 x 3-7/8 (31.12 x 22.38 x 8.84)	H052 / L089	foam option available
15658	PV 3-1/8	12-11/16 x 8-15/16 x 2-13/16 (32.23 x 22.70 x 7.14)	7/16 (1.11)	g = 5/8 (1.59) h = 2-3/16 (5.56)	13-1/2 x 10-13/16 x 3-1/8 (34.29 x 27.46 x 7.94)	H052 / L089	
16952	PV 3-7/16	12-11/16 x 8-15/16 x 3-1/8 (32.23 x 22.70 x 7.94)	7/16 (1.11)	g = 15/16 (2.38) h = 2-3/16 (5.56)	13-1/2 x 10-13/16 x 3-7/16 (34.29 x 27.46 x 8.73)	H052 / L089	
16541	PV 3-11/16	12-11/16 x 8-15/16 x 3-3/8 (32.23 x 22.70 x 8.57)	7/16 (1.11)	g = 5/8 (1.59) h = 2-3/4 (6.99)	13-1/2 x 10-13/16 x 3-11/16 (34.29 x 27.46 x 9.37)	H052 / L089	
17976 50024	PV 4	12-11/16 x 8-15/16 x 3-11/16 (32.23 x 22.70 x 9.37)	7/16 (1.11)	g = 15/16 (2.38) h = 2-3/4 (6.99)	13-1/2 x 10-13/16 x 4 (34.29 x 27.46 x 10.16)	H052 / L089	foam option available
12276 50026	PV 5-1/8	12-11/16 x 8-15/16 x 4-3/4 (32.23 x 22.70 x 12.07)	7/16 (1.11)	g = 1-1/2 (3.81) h = 3-1/4 (8.26)	13-1/2 x 10-13/16 x 5-1/8 (34.29 x 27.46 x 13.02)	H052 / L089	foam option available
16965	PV 6-1/8	12-11/16 x 8-15/16 x 5-5/8 (32.23 x 22.70 x 14.29)	7/16 (1.11)	g = 1-7/8 (4.76) h = 3-3/4 (9.53)	13-1/2 x 10-13/16 x 6-1/8 (34.29 x 27.46 x 15.56)	H052 / L089	
11583 50030	PW 4	14 x 10-3/4 x 3-1/2 (35.56 x 27.31 x 8.89)	1-1/4 (3.18)	g = 5/8 (1.59) h = 2-7/8 (7.30)	15-1/2 x 13-5/16 x 4 (39.37 x 33.81 x 10.16)	H0230M / L085	foam option available
11585	PW 4-3/4	14 x 10-3/4 x 4-1/4 (35.56 x 27.31 x 10.80)	1-1/4 (3.18)	g = 1-3/8 (3.49) h = 2-7/8 (7.30)	15-1/2 x 13-5/16 x 4-3/4 (39.37 x 33.81 x 12.07)	H0230M / L085	
11598	PW 4-3/4	14 x 10-3/4 x 4 (35.56 x 27.31 x 10.16)	1-1/4 (3.18)	g = 1-3/8 (3.49) h = 2-5/8 (6.67)	15-1/2 x 13-5/16 x 4-3/4 (39.37 x 33.81 x 12.07)	H0230M / L085	double wall base
11664	PW 5-1/2	14 x 10-3/4 x 5 (35.56 x 27.31 x 12.70)	1-1/4 (3.18)	g = 2-1/8 (5.40) h = 2-7/8 (7.30)	15-1/2 x 13-5/16 x 5-1/2 (39.37 x 33.81 x 13.97)	H0230M / L085	
17977 50053	PW 6-1/4	14 x 10-3/4 x 5-3/4 (35.56 x 27.31 x 14.61)	1-1/4 (3.18)	g = 2-1/8 (5.40) h = 3-5/8 (9.21)	15-1/2 x 13-5/16 x 6-1/4 (39.37 x 33.81 x 15.88)	H0230M / L026	foam option available 17977 uses latch L085
11588	PW 6-1/4	14 x 10-3/4 x 5-5/8 (35.56 x 27.31 x 14.29)	1-1/4 (3.18)	g = 2-3/4 (6.98) h = 2-7/8 (7.30)	15-1/2 x 13-5/16 x 6-1/4 (39.37 x 33.81 x 15.88)	H0230M / L085	
12090	PX 3-1/2	17 x 13 x 3 (43.18 x 33.02 x 7.62)	15/16 (2.38)	g = 1-3/8 (3.49) h = 1-5/8 (4.13)	18-1/2 x 15-9/16 x 3-1/2 (46.99 x 39.53 x 8.89)	Integral / L037	
16607 50050	PX 5	17 x 13 x 4-1/2 (43.18 x 33.02 x 11.43)	15/16 (2.38)	g = 1-3/8 (3.49) h = 3-1/8 (7.94)	18-1/2 x 15-9/16 x 5 (46.99 x 39.53 x 12.70)	H0230M / L026	
12097	PX 6-1/4	17 x 13 x 5-5/8 (43.18 x 33.02 x 14.29)	15/16 (2.38)	g = 1-3/4 (4.45) h = 3-7/8 (9.84)	18-1/2 x 15-9/16 x 6-1/4 (46.99 x 39.53 x 15.88)	Integral / L037	
12101 50051	PX 8	17 x 13 x 7-3/8 (43.18 x 33.02 x 18.73)	15/16 (2.38)	g = 3-1/2 (8.89) h = 3-7/8 (9.84)	18-1/2 x 15-9/16 x 8 (46.99 x 39.53 x 20.32)	H0230M / L026	
12023	PX 8	17 x 13 x 7-3/8 (43.18 x 33.02 x 18.73)	15/16 (2.38)	g = 3-1/2 (8.89) h = 3-7/8 (9.84)	18-1/2 x 15-9/16 x 8 (46.99 x 39.53 x 20.32)	H0230M / L085	
18925	PX 8	17 x 13 x 7 (43.18 x 33.02 x 17.78)	15/16 (2.38)	g = 3-1/2 (8.89) h = 3-1/2 (8.89)	18-1/2 x 15-9/16 x 8 (46.99 x 39.53 x 20.32)	H0230M / L085	
12211 50045	PZ 4-1/2	24-1/2 x 13 x 3-5/8 (62.23 x 33.02 x 9.21)	1-1/8 (2.86)	g = 7/8 (2.22) h = 2-3/4 (6.99)	26 x 15-9/16 x 4-1/2 (66.04 x 39.53 x 11.43)	H0230M / L095	
12414 50088	PZ 8	24-1/2 x 13 x 7-3/8 (62.23 x 33.02 x 18.73)	1-1/8 (2.86)	g = 3-1/2 (8.89) h = 3-7/8 (9.84)	26 x 15-9/16 x 8 (66.04 x 39.53 x 20.32)	H0230M / L095	foam option available optional integral handle
12415 50415	PZ 9	24-1/2 x 13 x 8-3/8 (62.23 x 33.02 x 21.27)	1-1/8 (2.86)	g = 3-1/2 (8.89) h = 4-7/8 (12.38)	26 x 15-9/16 x 9 (66.04 x 39.53 x 22.86)	H0230M / L095	foam option available optional integral handle

CASES: AIRMOLD® “R” SERIES

Airmold® “R” Series - Integral Hinge Case



Expect performance from the Flambeau “R” series cases. With a wide range of cases to choose from, this case family features an integral hinge and latch system. This case is simple and reliable and is our most economical blow molded case offering.

Constructed from high-density polyethylene (HDPE) this case is tough enough for almost any challenge. Available as a double-wall case, or with a routed base to accommodate foam, this case offers maximum protection. A broad range of sizes and depths are available.



Drawing Key

- a = Exterior Length
- b = Exterior Width
- c = Overall Exterior Depth
- d = Interior/Routed Opening Length
- e = Interior/Routed Opening Width
- f = Overall Interior Depth
- g = Interior Lid Depth
- h = Interior Base Depth
- i = Routed Depth

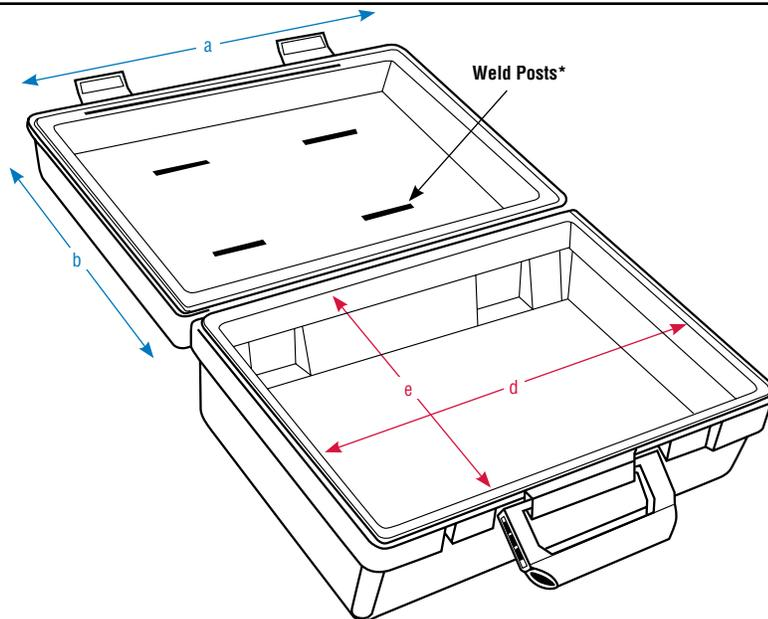
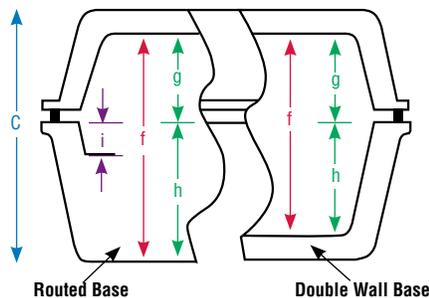

* Number of weld posts may vary.

Airmold “R” Series Cases Continued on page 43

CASES: AIRMOLD® “R” SERIES

Stock Number	Style	Interior Dimensions: L x W x overall D (d x e x f) inches (cm)	Routed Depth = i inches (cm)	Interior Depth: Lid = g Base = h inches (cm)	Exterior Dimensions: L x W x overall D (a x b x c) inches (cm)	Standard Handle / Latch	Comments inches (cm)
2504	RA 2-1/16	6-5/8 x 4-3/4 x 1-3/4 (16.83 x 12.07 x 4.45)	7/16 (1.11)	g = 5/8 (1.59) h = 1-1/8 (2.86)	7-1/2 x 5-3/4 x 2-1/16 (19.05 x 14.61 x 5.24)	none / Integral	
9431	RA 2-5/8	6-5/8 x 4-3/4 x 2-5/16 (16.83 x 12.07 x 5.87)	7/16 (1.11)	g = 15/16 (2.38) h = 1-3/8 (3.49)	7-1/2 x 5-3/4 x 2-5/8 (19.05 x 14.61 x 6.67)	none / Integral	
2505	RA 3-7/16	6-5/8 x 4-3/4 x 3-1/8 (16.83 x 12.07 x 7.94)	7/16 (1.11)	g = 1 (2.54) h = 2-3/16 (5.56)	7-1/2 x 5-3/4 x 3-7/16 (19.05 x 14.61 x 8.73)	none / Integral	
48-9411	RB 1-1/4	6-13/16 x 3-3/16 x 15/16 (17.30 x 8.10 x 2.38)	1/4 (0.64)	g = 1/8 (0.32) h = 13/16 (2.06)	7-1/2 x 4 x 1-1/4 (19.05 x 10.16 x 3.18)	none / Integral	
48-9512	RB 1-5/8	6-13/16 x 3-3/16 x 1-5/16 (17.30 x 8.10 x 3.33)	1/4 (0.64)	g = 1/8 (0.32) h = 1-3/16 (3.02)	7-1/2 x 4 x 1-5/8 (19.05 x 10.16 x 1.59)	none / Integral	
48-9513	RB 1-5/8	6-13/16 x 3-3/16 x 1-5/16 (17.30 x 8.10 x 3.33)	1/4 (0.64)	g = 1/2 (1.27) h = 13/16 (2.06)	7-1/2 x 4 x 1-5/8 (19.05 x 10.16 x 1.59)	none / Integral	
48-9514	RB 2	6-13/16 x 3-3/16 x 1-11/16 (17.30 x 8.10 x 4.29)	1/4 (0.64)	g = 1/2 (1.27) h = 1-3/16 (3.02)	7-1/2 x 4 x 2 (19.05 x 10.16 x 5.08)	none / Integral	
48-9515	RB 2	6-13/16 x 3-3/16 x 1-11/16 (17.30 x 8.10 x 4.29)	1/4 (0.64)	g = 7/8 (2.22) h = 13/16 (2.06)	7-1/2 x 4 x 2 (19.05 x 10.16 x 5.08)	none / Integral	
48-9516	RB 2-3/8	6-13/16 x 3-3/16 x 2-1/16 (17.30 x 8.10 x 5.24)	1/4 (0.64)	g = 1/2 (1.27) h = 1-9/16 (3.97)	7-1/2 x 4 x 2-3/8 (19.05 x 10.16 x 6.03)	none / Integral	
48-9517	RB 2-3/8	6-13/16 x 3-3/16 x 2-1/16 (17.30 x 8.10 x 5.24)	1/4 (0.64)	g = 7/8 (2.22) h = 1-3/16 (3.02)	7-1/2 x 4 x 2-3/8 (19.05 x 10.16 x 6.03)	none / Integral	
48-9518	RB 2-3/4	6-13/16 x 3-3/16 x 2-7/16 (17.30 x 8.10 x 6.19)	1/4 (0.64)	g = 1/2 (1.27) h = 1-15/16 (4.92)	7-1/2 x 4 x 2-3/4 (19.05 x 10.16 x 6.99)	none / Integral	
48-9519	RB 2-3/4	6-13/16 x 3-3/16 x 2-7/16 (17.30 x 8.10 x 6.19)	1/4 (0.64)	g = 7/8 (2.22) h = 1-9/16 (3.97)	7-1/2 x 4 x 2-3/4 (19.05 x 10.16 x 6.99)	none / Integral	
48-9520	RB 3-1/8	6-13/16 x 3-3/16 x 2-13/16 (17.30 x 8.10 x 7.14)	1/4 (0.64)	g = 7/8 (2.22) h = 1-15/16 (4.92)	7-1/2 x 4 x 3-1/8 (19.05 x 10.16 x 7.94)	none / Integral	
2500	RC 1-3/4	7-9/16 x 5-7/8 x 1-7/16 (19.21 x 14.92 x 3.65)	7/16 (1.11)	g = 5/8 (1.59) h = 13/16 (2.06)	8-1/2 x 7 x 1-3/4 (21.59 x 17.78 x 4.45)	none / Integral	
2509	RC 2-3/8	7-9/16 x 5-7/8 x 2-1/16 (19.21 x 14.92 x 5.24)	7/16 (1.11)	g = 1 (2.54) h = 1-1/8 (2.86)	8-1/2 x 7 x 2-3/8 (21.59 x 17.78 x 6.03)	none / Integral	
2513	RC 3-7/8	7-9/16 x 5-7/8 x 3-9/16 (19.21 x 14.92 x 9.05)	7/16 (1.11)	g = 1 (2.54) h = 2-5/8 (6.67)	8-1/2 x 7 x 3-7/8 (21.59 x 17.78 x 9.84)	H001 / Integral	
2524	RF 1-3/4	8-5/8 x 4 x 1-7/16 (21.91 x 10.16 x 3.65)	7/16 (1.11)	g = 5/8 (1.59) h = 13/16 (2.06)	9-1/2 x 5 x 1-3/4 (24.13 x 12.70 x 4.45)	none / Integral	
2527	RF 3-1/8	8-5/8 x 4 x 2-13/16 (21.91 x 10.16 x 7.14)	7/16 (1.11)	g = 5/8 (1.59) h = 2-3/16 (5.56)	9-1/2 x 5 x 3-1/8 (24.13 x 12.70 x 7.94)	H001 / Integral	
2532	RH 1-3/4	9-1/8 x 6-1/2 x 1-7/16 (23.18 x 16.51 x 3.65)	7/16 (1.11)	g = 5/8 (1.59) h = 13/16 (2.06)	10 x 7-1/2 x 1-3/4 (25.40 x 19.05 x 4.45)	none / Integral	
2533	RH 2-3/8	9-1/8 x 6-1/2 x 2-1/16 (23.18 x 16.51 x 5.24)	7/16 (1.11)	g = 1 (2.54) h = 1-1/8 (2.86)	10 x 7-1/2 x 2-3/8 (25.40 x 19.05 x 6.03)	none / Integral	
2534	RH 3-1/8	9-1/8 x 6-1/2 x 2-13/16 (23.18 x 16.51 x 7.14)	7/16 (1.11)	g = 5/8 (1.59) h = 2-3/16 (5.56)	10 x 7-1/2 x 3-1/8 (25.40 x 19.05 x 7.94)	H001 / Integral	
2541	RH 3-7/16	9-1/8 x 6-1/2 x 3-1/8 (23.18 x 16.51 x 7.94)	7/16 (1.11)	g = 1 (2.54) h = 2-3/16 (5.56)	10 x 7-1/2 x 3-7/16 (25.40 x 19.05 x 7.94)	H001 / Integral	
2537	RH 3-7/8	9-1/8 x 6-1/2 x 3-9/16 (23.18 x 16.51 x 9.05)	7/16 (1.11)	g = 1 (2.54) h = 2-5/8 (6.67)	10 x 7-1/2 x 3-7/8 (25.40 x 19.05 x 9.84)	H001 / Integral	
2547	RK 2-3/8	10-1/8 x 4-1/4 x 2-1/16 (25.72 x 10.80 x 5.34)	7/16 (1.11)	g = 15/16 (2.38) h = 1-1/8 (2.86)	11 x 5-1/4 x 2-3/8 (27.94 x 13.34 x 6.03)	none / Integral	
2549	RK 3-1/8	10-1/8 x 4-1/4 x 2-13/16 (25.72 x 10.80 x 7.14)	7/16 (1.11)	g = 5/8 (1.59) h = 2-3/16 (5.56)	11 x 5-1/4 x 3-1/8 (27.94 x 13.34 x 7.94)	H001 / Integral	
9624	RK 3-9/16	10-1/8 x 4-1/4 x 3-1/4 (25.72 x 10.80 x 8.26)	7/16 (1.11)	g = 5/8 (1.59) h = 2-5/8 (6.67)	11 x 5-1/4 x 3-9/16 (27.94 x 13.34 x 9.05)	H001 / Integral	
2560	RN 1-3/4	11-3/8 x 5-1/4 x 1-7/16 (28.89 x 13.34 x 3.65)	7/16 (1.11)	g = 5/8 (1.59) h = 13/16 (2.06)	12-1/4 x 6-1/4 x 1-3/4 (31.12 x 15.88 x 4.45)	none / Integral	
2569	RN 3-7/16	11-3/8 x 5-1/4 x 3-1/8 (28.89 x 13.34 x 7.94)	7/16 (1.11)	g = 15/16 (2.38) h = 2-3/16 (5.56)	12-1/4 x 6-1/4 x 3-7/16 (31.12 x 15.88 x 8.73)	H001 / Integral	
2565	RN 3-7/8	11-3/8 x 5-1/4 x 3-9/16 (28.89 x 13.34 x 9.05)	7/16 (1.11)	g = 15/16 (2.38) h = 2-5/8 (6.67)	12-1/4 x 6-1/4 x 3-7/8 (31.12 x 15.88 x 9.84)	H001 / Integral	
2574	RQ 1-3/4	11-3/8 x 7 x 1-7/16 (28.89 x 17.78 x 3.65)	7/16 (1.11)	g = 5/8 (1.59) h = 13/16 (2.06)	12-1/4 x 8 x 1-3/4 (31.12 x 20.32 x 4.45)	none / Integral	
2581	RQ 2-1/16	11-3/8 x 7 x 1-3/4 (28.89 x 17.78 x 4.45)	7/16 (1.11)	g = 5/8 (1.59) h = 1-1/8 (2.86)	12-1/4 x 8 x 2-1/16 (31.12 x 20.32 x 5.24)	none / Integral	
2575	RQ 2-3/8	11-3/8 x 7 x 2-1/16 (28.89 x 17.78 x 5.24)	7/16 (1.11)	g = 1 (2.54) h = 1-1/8 (2.86)	12-1/4 x 8 x 2-3/8 (31.12 x 20.32 x 6.03)	none / Integral	

“R” Series Cases Continued on page 44

CASES: AIRMOLD® “R” SERIES

Stock Number	Style	Interior Dimensions: L x W x overall D (d x e x f) inches (cm)	Routed Depth = i inches (cm)	Interior Depth: Lid = g Base = h inches (cm)	Exterior Dimensions: L x W x overall D (a x b x c) inches (cm)	Standard Handle / Latch	Comments inches (cm)
7144	RQ 2-3/4	11-3/8 x 7 x 2-3/8 (28.89 x 17.78 x 6.03)	7/16 (1.11)	g = 1-1/4 (3.18) h = 1-1/8 (2.86)	12-1/4 x 8 x 2-3/4 (31.12 x 20.32 x 6.99)	none / Integral	
2577	RQ 3-1/8	11-3/8 x 7 x 2-13/16 (28.89 x 17.78 x 7.14)	7/16 (1.11)	g = 5/8 (1.59) h = 2-3/16 (5.56)	12-1/4 x 8 x 3-1/8 (31.12 x 20.32 x 7.94)	H052 / Integral	
2579	RQ 3-7/8	11-3/8 x 7 x 3-9/16 (28.89 x 17.78 x 9.05)	7/16 (1.11)	g = 1 (2.54) h = 2-5/8 (6.67)	12-1/4 x 8 x 3-7/8 (31.12 x 20.32 x 9.84)	H001 / Integral	
2585	RQ 4-1/4	11-3/8 x 7 x 3-7/8 (28.89 x 17.78 x 9.84)	7/16 (1.11)	g = 1-1/4 (3.18) h = 2-5/8 (6.67)	12-1/4 x 8 x 4-1/4 (31.12 x 20.32 x 10.80)	H001 / Integral	
2588	RT 1-3/4	11-5/8 x 3-1/4 x 1-7/16 (29.53 x 8.26 x 3.65)	7/16 (1.11)	g = 5/8 (1.59) h = 13/16 (2.06)	12-1/2 x 4-1/4 x 1-3/4 (31.75 x 10.80 x 4.45)	none / Integral	
2590	RT 3-1/8	11-5/8 x 3-1/4 x 2-13/16 (29.53 x 8.26 x 7.14)	7/16 (1.11)	g = 5/8 (1.59) h = 2-3/16 (5.56)	12-1/2 x 4-1/4 x 3-1/8 (31.75 x 10.80 x 7.94)	none / Integral	
2618	RV 2-1/16	12-11/16 x 8-15/16 x 1-3/4 (32.23 x 22.70 x 4.45)	7/16 (1.11)	g = 5/8 (1.59) h = 1-1/8 (2.86)	13-1/2 x 10 x 2-1/16 (34.29 x 25.40 x 5.24)	none / Integral	
2596	RV 2-3/8	12-11/16 x 8-15/16 x 2-1/16 (32.23 x 22.70 x 5.24)	7/16 (1.11)	g = 1 (2.54) h = 1-1/8 (2.86)	13-1/2 x 10 x 2-3/8 (34.29 x 25.40 x 6.03)	none / Integral	
2597	RV 3-1/8	12-11/16 x 8-15/16 x 2-13/16 (32.23 x 22.70 x 7.14)	7/16 (1.11)	g = 5/8 (1.59) h = 2-3/16 (5.56)	13-1/2 x 10 x 3-1/8 (34.29 x 25.40 x 7.94)	none / Integral	
2611	RV 3-7/16	12-11/16 x 8-15/16 x 2-13/16 (32.23 x 22.70 x 7.14)	7/16 (1.11)	g = 5/8 (1.59) h = 2-13/16 (7.14)	13-1/2 x 10 x 3-7/16 (34.29 x 25.40 x 8.73)	H024 / Integral	
2600	RV 4	12-11/16 x 8-15/16 x 3-11/16 (32.23 x 22.70 x 9.67)	7/16 (1.11)	g = 1 (2.54) h = 2-3/4 (6.99)	13-1/2 x 10 x 4 (34.29 x 25.40 x 10.16)	H052 / Integral	
2605	RV 5-1/8	12-11/16 x 8-15/16 x 4-3/4 (32.23 x 22.70 x 12.07)	7/16 (1.11)	g = 1-1/2 (3.81) h = 3-1/4 (8.26)	13-1/2 x 10 x 5-1/8 (34.29 x 25.40 x 13.02)	H024 / Integral	
2619	RV 6-1/8	12-11/16 x 8-15/16 x 5-5/8 (32.23 x 22.70 x 14.29)	7/16 (1.11)	g = 1-7/8 (4.76) h = 3-3/4 (9.53)	13-1/2 x 10 x 6-1/8 (34.29 x 25.40 x 15.56)	H024 / Integral	
7205	RW 4-3/4	14 x 10-3/4 x 4-1/4 (35.56 x 27.31 x 10.80)	1-1/4 (3.18)	g = 1-3/8 (3.49) h = 2-7/8 (7.30)	15-1/2 x 12-1/4 x 4-3/4 (39.37 x 31.12 x 12.07)	H0230M/Integral	optional integral handle
7279	RW 5-1/2	14 x 10-3/4 x 5 (35.56 x 27.31 x 12.70)	1-1/4 (3.18)	g = 2-1/8 (5.40) h = 2-7/8 (7.30)	15-1/2 x 12-1/4 x 5-1/2 (39.37 x 31.12 x 13.97)	H0230M/Integral	optional integral handle
7207	RW 5-1/2	14 x 10-3/4 x 5 (35.56 x 27.31 x 12.70)	1-1/4 (3.18)	g = 1-3/8 (3.49) h = 3-5/8 (9.21)	15-1/2 x 12-1/4 x 5-1/2 (39.37 x 31.12 x 13.97)	H0230M/Integral	optional integral handle
7203	RW 6-1/4	14 x 10-3/4 x 5-3/4 (35.56 x 27.31 x 14.61)	1-1/4 (3.18)	g = 2-1/8 (5.40) h = 3-5/8 (9.21)	15-1/2 x 12-1/4 x 6-1/4 (39.37 x 31.12 x 15.88)	H0230M/Integral	optional integral handle
14523	RX 3	17 x 13 x 2-1/2 (43.18 x 33.02 x 6.35)	15/16 (2.38)	g = 7/8 (2.22) h = 1-5/8 (4.13)	18-1/2 x 14-1/2 x 3 (46.99 x 36.83 x 7.62)	H0230M/Integral	optional integral handle
2725	RX 5	17 x 13 x 4-1/2 (43.18 x 33.02 x 11.43)	15/16 (2.38)	g = 1-3/8 (3.49) h = 3-1/8 (7.94)	18-1/2 x 14-1/2 x 5 (46.99 x 36.83 x 12.70)	H0230M/Integral	optional integral handle
2728	RX 6-1/4	17 x 13 x 5-5/8 (43.18 x 33.02 x 14.29)	15/16 (2.38)	g = 1-3/4 (4.45) h = 3-7/8 (9.84)	18-1/2 x 14-1/2 x 6-1/4 (46.99 x 36.83 x 12.70)	H0230M/Integral	optional integral handle
2742	RX 8	17 x 13 x 7-3/8 (43.18 x 33.02 x 18.73)	15/16 (2.38)	g = 3-1/2 (8.89) h = 3-7/8 (9.84)	18-1/2 x 14-1/2 x 8 (46.99 x 36.83 x 20.32)	H0230M / L037	optional integral handle

Beta Case

Durability is built into this case! Made of high-density polyethylene (HDPE), this case is impervious to most common chemicals. Featuring an integral handle, hinge and latch system, the Beta Case is built tough.



Model Number	Stock Number	Description inches (centimeters)	Dimensions (Inside, L x W x D)	Packed
21496	21496	Color: Black, double-wall case Lid Depth = 1-1/2 (3.81) Base Depth = 1-1/2 (3.81)	13" x 8-1/2" x 2-3/4" (33.02 x 21.59 x 6.99 cm)	16/ctn
50237	50237	Color: Black, double-wall case with small logo plate Lid Depth = 1-1/2 (3.81) Base Depth = 1-1/2 (3.81)	13" x 8-1/2" x 2-3/4" (33.02 x 21.59 x 6.99 cm)	16/ctn

CASES: BLACK RIBBON™

Black Ribbon™ Cases

Flambeau introduces a new product line of **water resistant cases** available in four sizes! Each precision Black Ribbon™ case features a 360 degree. These extremely durable cases also feature a metal front cam locking mechanical latch system and external rubber bumpers for impact absorption, skid resistance, and greater durability. Cases are made of tough impact resistant ABS plastic.

Flambeau Black Ribbon Cases (shown below) are sold with "open" core or flat foam lid and base. Cases can easily be outfitted with die cut foam inserts when required for added nesting and protection of your valuables. These cases are excellent for outdoor use in demanding environments. They are ideal for storing and protecting cell phones, iPods, electronic devices, jewelry, small tools and components.

Sample usage
Rugged and water resistant!



Model Number	Stock Number	Description	Dimensions (Inside, L x W x D)	Packed
6734PC	6734PC	4-3/8" (11.11 cm) Black - without Foam	3-7/8" x 2-3/8" x 1-3/8" (9.84 x 6.03 x 3.49 cm)	4/ctn
6734PF	6734PF	4-3/8" (11.11 cm) Black - with Flat Foam Lid & Base		
6735PC	6735PC	5" (12.70 cm) Black - without Foam	4-3/8" x 2-7/8" x 1-3/8" (11.11 x 7.30 x 3.49 cm)	4/ctn
6735PF	6735PF	5" (12.70 cm) Black - with Flat Foam Lid & Base		
6736PC	6736PC	6-1/4" (15.56 cm) Black - without Foam	5-7/8" x 2-3/4" x 1-1/2" (14.92 x 6.99 x 3.81 cm)	4/ctn
6736PF	6736PF	6-1/4" (15.56 cm) Black - with Flat Foam Lid & Base		
6737PC	6737PC	7-3/4" (19.69 cm) Black - without Foam	7-1/8" x 3-5/8" x 1-11/16" (18.10 x 9.21 x 4.29 cm)	4/ctn
6737PF	6737PF	7-3/4" (19.69 cm) Black - with Flat Foam Lid & Base		
6738PC	6737PC	8-3/4" (22.23 cm) Black - without Foam	8-1/2" x 5-1/4" x 2-1/4" (21.59 x 13.34 x 5.72 cm)	4/ctn

CASES: ACCESSORIES

Flambeau Case Handles & Latches

Infinity (Reference Chart on page 38)



Handle - H052

Styles: FH, FQ (4-1/2 only) & FV



Handle - H023

Styles: FW & FX



Over Mold Grip Handle - H0230M

Styles: FH, FQ, FV, FW, FX & FZ



Latch - L085

Style: FW



Latch - L115

Style: FZ (8-1/2)

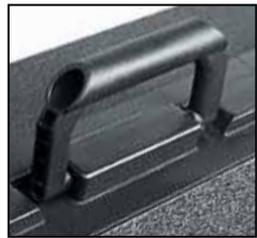

Handle - H074

Style: FZ



Latch - L089

Styles: FH, FQ & FV



Latch - L095

Style: FX



Latch - L116

Style: FZ (7)

"P" Series (Reference Chart on page 40-41)

Some cases do not have a handle option available, please see [page 40-41](#) to see which specific cases they are.



Handle - H001

Styles: PC, PF (3-1/8 only), PH



Handle - H052

Styles: PQ (3-7/16, 3-13/16 & 3-7/8 only), PV



Handle - H023

Styles: PW (4, 4-3/4, 5-1/2 & 6-1/4 only), PX (8 only), PZ



Handle - Integral

Styles: PW, PX & PZ



Latch - L089

Styles: PB, PC, PF, PH, PQ, PV



Latch - L085

Styles: PW (4, 4-3/4, 5-1/2 & 6-1/4 only), PX (8 only)



Latch - L026

Styles: PW (6-1/4 only)
PX (5 & 8 only)



Latch - L037

Styles: PX (3-1/2, 5, 6-1/4 & 8 only)



Latch - L095

Use with Style: PZ

Airmold® "R" Series (Reference Chart on page 42-44)

Some cases do not have a handle option available, please see [page 42-44](#) to see which specific cases they are.



Handle - H001

Styles: RA (3-1/8 & 3-7/16 only), RC (3-7/8 only), RF (3-1/8 only), RH (3-1/8, 3-7/16 & 3-7/8 only), RK (3-1/8 & 3-9/16 only), RN (3-7/16 & 3-7/8 only) & RQ (3-7/8 & 4-1/4 only)



Handle - H024

Style: RV (3-7/16, 5-1/8 & 6-1/8 only)



Handle - H023

Styles: RW, RX

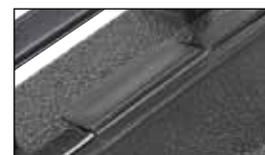

Latch - Integral

Styles: RA, RB, RC, RF, RH, RK, RN, RQ, RT, RV, RW, & RX (3, 5 & 6-1/4 only)



Latch - L037

Styles: RX (8 only)

Optional Handles and Latches



Handle - Integral
P Series Case Styles
PW, PX & PZ
R Series Case Styles
RW & RX

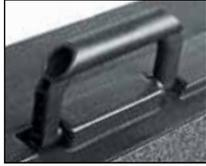

Handle - H074
Gear Box & Custom Case
Applications Only



Handle - H040
Custom Case Applications
Only



**Infinity Metal
Latch - L078**
Styles FW, FX & Custom
Case Applications



Latch - L115
Custom Case Applications
Only



Latch - L0110
Custom Case Applications
Only

Display Windows

The windows are manufactured from a clear plastic resin and can be hot stamped with your company name or logo. Four sizes of windows are available and are custom fitted to our pin hinge style cases.



AR1466 (L x W)
7-1/2" x 3-1/2"
(19.05 x 8.89 cm)



AR1536 (L x W)
10-1/4" x 3"
(26.04 x 7.62 cm)



X-1191 Small (L x W)
5-15/16" x 1-15/16"
(15.08 x 4.92 cm)



X-1193 Large (L x W)
8-7/16" x 2-3/16"
(21.43 x 5.56 cm)

Additional Options



Flambeau Purge Valve



Perimeter Gasket



**Custom Small & Large
Exterior Logo Plate**
additional tooling expense



Lid Stays



Interior Door(s)
additional tooling expense



Interior Tray(s)
additional tooling expense



Security Feature

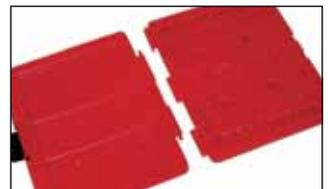

Removable Lid



**Literature Holder
Routed Slot**



**Literature Holder
Plastic Clip - X893**



**Literature Holder
Elastic Strap**



Pallets and/or File Folders

For information on Flambeau's Custom Capabilities see the Custom Capabilities Section starting on page 8.

CASES: BLOW MOLDED TRADESMAN™ & MAILERS

Blow Molded Tradesman™ Case

Featuring extra thick walls the Blow Molded Tradesman is one of our most durable cases. This high-density polyethylene (HDPE) case is resistant to most common chemicals, gasoline and the harshest conditions. Simply, this case is built to be abused! The sleek design includes an integral handle, hinge and latch system.

We encourage you to challenge this case!



Features a logo area for customization



19978

Model Number	Stock Number	Description	Dimensions (Inside, L x W x D)	Packed
19978	19978	Black double-wall case with logo plate area	15" x 8-1/2" x 3-1/2" (38.10 x 21.59 x 8.89 cm)	16/ctn

Mailers

Reusable shipping containers from Flambeau will help you save money and give you the durability needed to protect your cargo while in transit. Our blow molded mailers feature double-wall construction and are stackable. Offered with our standard convoluted foam they are designed to protect even the most sensitive cargo. Lids and bases are separate pieces for loading convenience and feature overlapping positive edges to reduce lid movement and provide a natural dust barrier. Lids and bases must be secured for transit. Made of high-density polyethylene (HDPE) our mailers are impervious to most common chemicals and gasoline.



mailer with convoluted foam



Model Number	Stock Number	Outside Dimensions (L x W x D) inches (cm)	Inside Dimensions (L x W x D) inches (cm)	Maximum Load Size (L x W x D) inches (cm)	Packed
8792 8792-PI04	8792-PI04	12" x 10" x 3" (30.48 x 25.40 x 7.62 cm)	9-1/2" x 7" x 1-5/8" (24.13 x 17.78 x 4.13 cm)	8-1/2" x 6" x 1" (21.59 x 15.24 x 2.54 cm)	32/ctn
8793 8793-PI05	8793-PI05	12" x 10" x 5" (30.48 x 25.40 x 12.70 cm)	9-1/2" x 7" x 4" (24.13 x 17.78 x 10.16 cm)	8-1/2" x 6" x 3-1/4" (21.59 x 15.24 x 8.26 cm)	32/ctn
8794 8794-PI06	8794-PI07	14" x 12" x 3" (35.56 x 30.48 x 7.62 cm)	11-1/2" x 9" x 1-5/8" (29.21 x 22.86 x 4.13 cm)	10-1/2" x 8" x 1" (26.67 x 20.32 x 2.54 cm)	32/ctn
8286 8286-PI07	8286-PI06	14" x 12" x 5" (35.56 x 30.48 x 12.70 cm)	11-1/2" x 9" x 4" (29.21 x 22.86 x 10.16 cm)	10-1/2" x 8" x 3-1/4" (26.67 x 20.32 x 8.26 cm)	32/ctn
8162 8162-PI14	8162-PI14	8" x 6" x 3" (20.32 x 15.24 x 7.62 cm)	6" x 4" x 1-5/8" (15.24 x 10.16 x 4.13 cm)	5" x 3" x 1" (12.70 x 7.62 x 2.54 cm)	48/ctn
8161 8161-PI19	8161-PI19	21" x 15" x 5" (53.34 x 38.10 x 12.70 cm)	18" x 12" x 4" (45.72 x 30.48 x 10.16 cm)	17" x 11" x 2-1/2" (43.18 x 27.94 x 6.35 cm)	6/ctn
10133 10133-PI20	10133-PI20	27" x 14-1/2" x 7" (68.58 x 36.83 x 17.78 cm)	24" x 12" x 6" (60.96 x 30.48 x 15.24 cm)	23" x 11" x 2-5/8" (58.42 x 27.94 x 6.67 cm)	3/ctn

Stationary & Mobile Storage

Flambeau's mobile and stationary storage systems can help you improve your space utilization and increase your productivity. Our wide variety of products gives you the flexibility to quickly select a system that works for your specific needs. With some of the most durable products in the industry, our extra heavy-duty products are constructed with copolymer resins, that are dent-proof, rust-proof, chemical-, scratch-, and impact-resistant and built to last! Many products feature brass pin hinges, positive cam-over latches, tongue and groove construction and other structural features that any professional would expect.

IDS™ Cabinets - Infinite Divider Storage System

A hybrid between mobile and stationary storage, these cabinets have interlocking grooves for easy and secure stacking. The IDS system truly gives you mastery over your storage space with (5) IDS translucent cases featuring dividers that can be placed every 1/16" (0.16 cm) throughout the compartments! From 1 compartment to 100 compartments, each individual case fits into its own tray within the cabinet and can be easily and quickly removed to be taken to a remote site while keeping the parts secure.

- Dent-proof polypropylene housing
- Interlocking stackable cabinets
- Easily moved
- Fully extendable drawers
- Removable cases
- Infinite Divider System

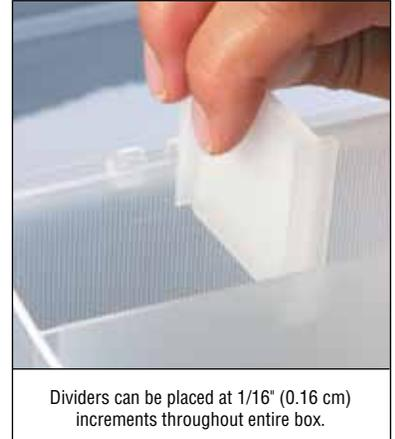

IDS Cabinet with 5 trays, no boxes



IDS Cabinet with 5 trays and (5) T900 Boxes



IDS Cabinet with 5 trays and (5) 999-2 Boxes



Special interlocking grooves on the cabinets allow them to be stacked on top of each other.

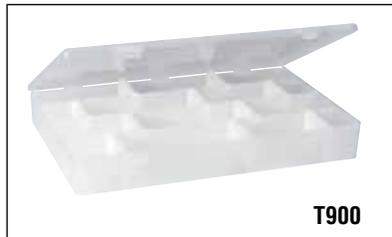

T900 Inside Dimensions (L x W x D)
13-1/8" x 8-7/8" x 1-15/16" (33.34 x 22.54 x 4.92 cm)



999-2 Inside Dimensions (L x W x D)
13-1/8" x 8-7/8" x 1-15/16" (33.34 x 22.54 x 4.92 cm)

Model Number	Stock Number	Description inch (centimeter)	Dimensions (Outside, L x W x D)	Packed
8500NT	8500NT	Cabinet with (5) trays, no boxes	15-1/4" x 14-3/4" x 16" (13.34 x 37.47 x 40.64 cm)	1/ctn
8500ST	8500ST	Cabinet with (5) trays and (5) T900 boxes T900 boxes come with 16 dividers	15-1/4" x 14-3/4" x 16" (13.34 x 37.47 x 40.64 cm)	1/ctn
8500JT	8500JT	Cabinet with (5) trays and (5) 999-2 boxes 999-2 boxes come with 16 dividers	15-1/4" x 14-3/4" x 16" (13.34 x 37.47 x 40.64 cm)	1/ctn

See the Compartmented Box Section (pages 14-34) for additional boxes that will work within the IDS Cabinet and for replacement T900 & 999-2 IDS boxes.

SPECIALTY STORAGE

Parts Station™ Storage Cabinets & Rototower™

High density storage, maximum organization and cost savings efficiency can be achieved with our generous selection of reinforced durable plastic frame storage cabinets and expandable Rototower. Each drawer cabinet features styrene translucent drawers and drawer stops to prevent accidental spills while our tower has a heavy-duty tip-resistant steel base with slip-proof feet. Easy rotation is aided by our extra large ball-bearing rotating system.



All cabinets include (10) 35/52 dividers, all other dividers are optional

Holds 16 Cabinets.

Uses the C26P and U45P Cabinets.

Not shown to scale, with cabinets to left.



160RT Rototower™

Model Number	Stock Number	Description	Uses Drawer	Uses Divider	Dimensions (Outside, L x W x H)	Packed
C20P	6575PC	Color: Gray Clear Styrene Drawers Clear Styrene Dividers	(15) TW (4) TQ (1) TF	35/52 50/64 57/275	12" x 6-1/4" x 11-1/4" (30.48 x 15.88 x 28.58 cm)	4/ctn
C26P	6576PC	Color: Gray Clear Styrene Drawers Clear Styrene Dividers	(15) TW (8) TQ (2) TJ (1) TF	35/52 50/64 57/135 57/275	12" x 6-1/4" x 16-1/2" (30.48 x 15.88 x 41.91 cm)	4/ctn
U30P	6573PC	Color: Gray Clear Styrene Drawers Clear Styrene Dividers	(30) TW	35/52	12" x 6-1/4" x 11-1/4" (30.48 x 15.88 x 28.58 cm)	4/ctn
U45P	6574PC	Color: Gray Clear Styrene Drawers Clear Styrene Dividers	(45) TW	35/52	12" x 6-1/4" x 16-1/2" (30.48 x 15.88 x 41.91 cm)	4/ctn
160RT	6798RT	Gray Rototower Holds 16 Cabinets. Uses C26P & U45P Cabinets Sold Separately	-	-	18-1/2" x 18-1/2" x 72-1/2"* (46.99 x 46.99 x 184.15 cm)	1/ctn

* from floor to top of cabinet

Replacement Drawers & Dividers* (Plastic Frame Cabinets)

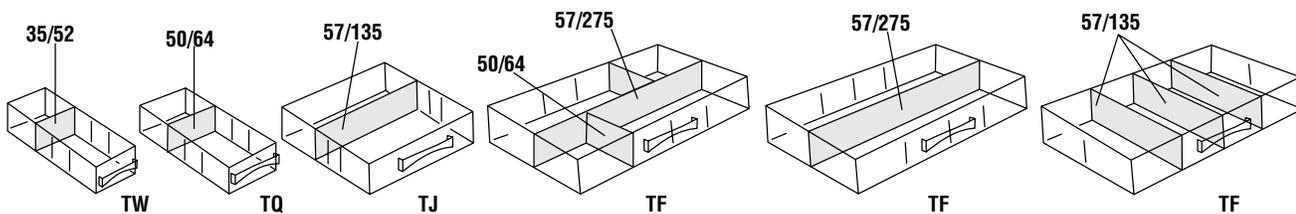

Model Number	Stock Number	Description	Dimensions (Inside, L x W x D)	Packed
TW	6062DP	Uses (3) 35/52 dividers, dividers sold separately	2" x 5-3/8" x 1-3/8" (5.08 x 13.65 x 3.49 cm)	6/pk
TQ	6063DP	Uses (3) 50/64 dividers, dividers sold separately	2-1/2" x 5-3/8" x 2-1/4" (6.35 x 13.65 x 5.72 cm)	6/pk
TJ	6066DP	Uses (3) 57/135 dividers, dividers sold separately	5-3/8" x 5-3/8" x 2-1/4" (13.65 x 13.65 x 5.72 cm)	6/pk
TF	6068DP	Uses (3) 57/135 or (1) 57/275 or (1) 57/275 & (6) 50/64 dividers, dividers sold separately	10-7/8" x 5-3/8" x 2-1/4" (27.62 x 13.65 x 5.72 cm)	6/pk

Model Number	Stock Number	Description	Dimensions (Inside, L x W x D)	Packed
35/52	6770DV	Divider fits in Drawer TW, Divider wall thickness 1/16" (1.588 cm)	2" x 1-1/4" x 1/8" (5.08 x 3.18 x 0.32 cm)	48/pk
50/64	6775DV	Divider fits in Drawer TQ & TF, Divider wall thickness 1/16" (1.588 cm)	2-1/2" x 2" x 1/8" (6.35 x 5.08 x 0.32 cm)	24/pk
57/135	6778DV	Divider fits in Drawers TF & TJ, Divider wall thickness 1/16" (1.588 cm)	5-3/8" x 2" x 1/8" (13.65 x 5.08 x 0.32 cm)	12/pk
57/275	6779DV	Divider fits in Drawers TF, Divider wall thickness 1/16" (1.588 cm)	10-7/8" x 2" x 1/8" (27.62 x 5.08 x 0.32 cm)	6/pk

* Contact Customer Service for large quantity divider purchases at 1-800-344-5716.

Satchel-Style Cases

A fantastic heavy-duty professional case! The Satchel case is commonly used as a parts or sales sample kit. The tinted lid is made of a high impact, scratch-resistant terpolymer, that gives you a quick view of parts. The case base, dividers, handle and catches are all molded from impact resistant polypropylene. Satchel Cases – a popular pick due to its durability, ease of use and an esthetic value. Large and small sizes available.

- Comfortable fold-down handle
- Can be customized (color or company logo)
- Tinted “quick-view” lid
- Rust-proof heavy-duty hinges

Small Satchel-Style Cases

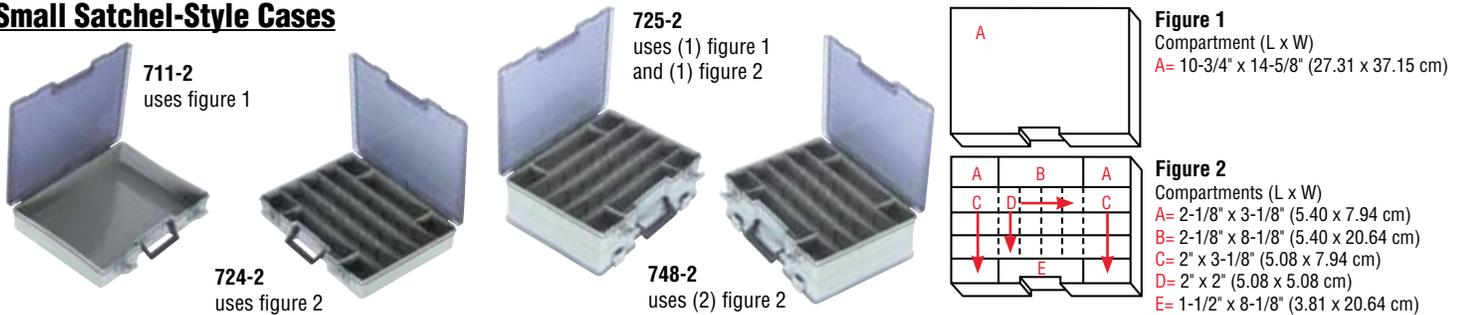

Model Number	Stock Number	Description inch (centimeter)	Dimensions (Outside, L x W x D)	Packed
711-2	6771UA	Tinted translucent lid, 1 compartment	15-1/2" x 11-3/4" x 2-1/2" (39.37 x 28.85 x 6.35 cm)	12/ctn
724-2	6770PA	Tinted translucent lid, 9-24 compartments, includes 15 movable dividers	15-1/2" x 11-3/4" x 2-1/2" (39.37 x 28.85 x 6.35 cm)	12/ctn
725-2	6773AB	Double sided with tinted translucent lid, 10-25 compartments, includes 15 movable dividers	15-1/2" x 11-3/4" x 5" (39.37 x 28.85 x 12.70 cm)	6/ctn
748-2	6772AD	Double sided with tinted translucent lid, 18-48 compartments, includes 30 movable dividers	15-1/2" x 11-3/4" x 5" (39.37 x 28.85 x 12.70 cm)	6/ctn

Divider Packs Available (sold separately): 12pk of dividers for 724-2, 725-2 & 748-2 is order #6020DP. Bulk pks of dividers for 724-2, 725-2 & 748-2 is order #602025

Large Satchel-Style Cases

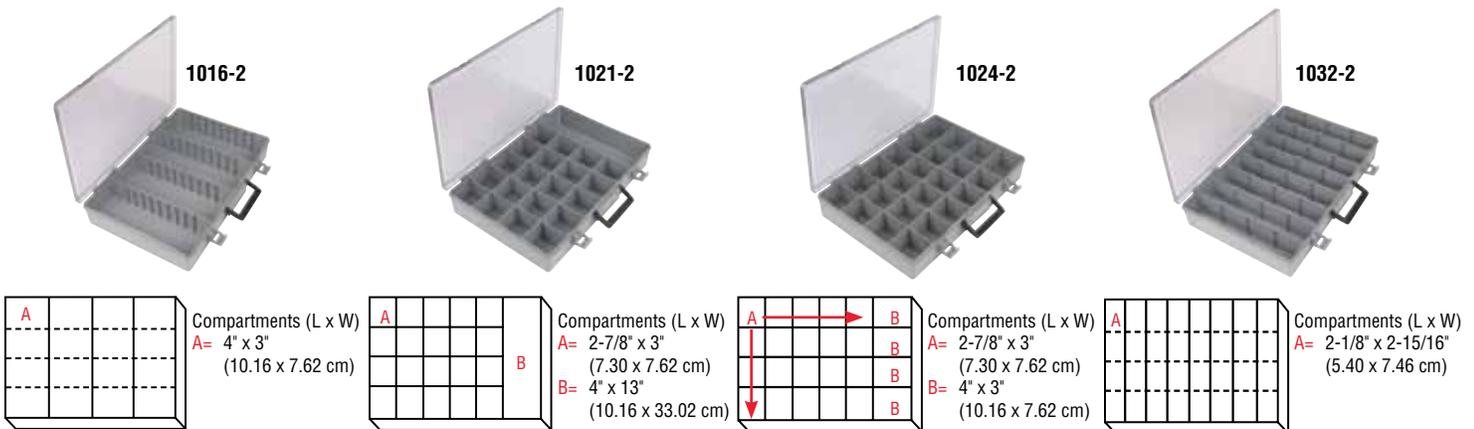

Model Number	Stock Number	Description inch (centimeter)	Dimensions (Outside, L x W x D)	Packed
1016-2	6745AB	Tinted translucent lid, 4-16 compartments Includes 12 movable dividers	18-1/2" x 13" x 3" (46.99 x 33.02 x 7.62 cm)	6/ctn
1021-2	6745AG	Tinted translucent lid, 21 compartments	18-1/2" x 13" x 3" (46.99 x 33.02 x 7.62 cm)	6/ctn
1024-2	6745AA	Tinted translucent lid, 24 compartments	18-1/2" x 13" x 3" (46.99 x 33.02 x 7.62 cm)	6/ctn
1032-2	6745AC	Tinted translucent lid, 8-32 compartments Includes 24 movable dividers	18-1/2" x 13" x 3" (46.99 x 33.02 x 7.62 cm)	6/ctn

Divider Packs Available (sold separately): 12 pk of dividers for 1016-2 is order #6014DP. Bulk pks of dividers for 1016-2 is order #601312. 12 pk of dividers for 1032-2 is order #6013DP. Bulk pks of dividers for 1032-2 is order #601303.

SPECIALTY STORAGE

Carry Packs™

Only from Flambeau! Carry Packs give your storage compartments mobility! From the shelf or wall (mountable), this system gives you the high density storage and organization you need and the freedom to easily get your parts to the work site.

- Each Carry Pack is stocked with specific compartmented boxes
- Boxes lock in place for ease of folding and carrying
- Each box can be quickly disengaged for part access
- Carry Pack frames are available with or without boxes
- Other boxes available for each Carry Pack*



21210-2 Folded

21210-2 Flat

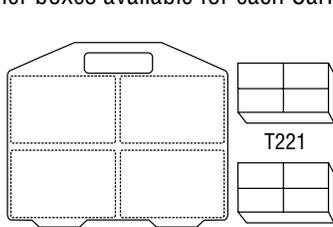

20220-2 Diagram (flat)

Comes with (2) T221 & (2) T220 Translucent Polypropylene Boxes**

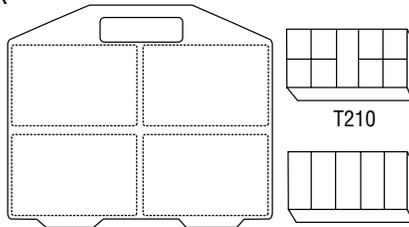

21210-2 Diagram (flat)

Comes with (2) T210 & (2) T215 Translucent Polypropylene Boxes**

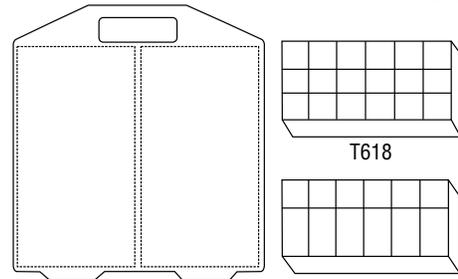

21600-2 Diagram (flat)

Comes with (1) T618 & (1) T612 Translucent Polypropylene Boxes**

Model Number	Stock Number	Description inch (centimeter)	Dimensions (Overall, L x W x D)	Packed
20220-2	6701VU	Comes with (2) T220 & (2) T221 Boxes Box (L x W x D) = 4-3/8 x 2-5/8 x 1 (11.11 x 6.67 x 2.54)	9-3/4" x 8-3/4" x 1-1/2" (24.77 x 22.23 x 3.81 cm)	6/ctn
6701NB	6701NB	Frame Only	9-3/4" x 8-3/4" x 1-1/2" (24.77 x 22.23 x 3.81 cm)	6/ctn
21210-2	6709VU	Comes with (2) T210 & (2) T215 Boxes Box (L x W x D) = 6-3/4 x 3-3/16 x 1-3/16 (17.15 x 8.10 x 3.02)	14-1/4" x 10-3/4" x 1-1/2" (36.20 x 27.31 x 3.81 cm)	6/ctn
6709NB	6709NB	Frame Only	14-1/4" x 10-3/4" x 1-1/2" (36.20 x 27.31 x 3.81 cm)	6/ctn
21600-2	6728VU	Comes with (1) T612 & (1) T618 Boxes Box (L x W x D) = 10-1/2 x 6-3/16 x 1-9/16 (26.67 x 15.72 x 3.97)	13-7/16" x 13-1/2" x 2-1/8" (34.13 x 34.29 x 5.40 cm)	6/ctn
6728NB	6728NB	Frame Only	13-7/16" x 13-1/2" x 2-1/8" (34.13 x 34.29 x 5.40 cm)	6/ctn

*Additional boxes (sold separately) available for the 20220-2 are: A220, K220, M220, A221, M221, A226, K226, and A228.

Additional boxes (sold separately) available for the 21210-2 are: A210, K210, M210, A211, A212, A213, A214, A215, K215, M215, A216, K216, A217, A219, K219, and T219

Additional boxes (sold separately) available the 21600-2 are: A601, K601, A602, K602, M602, A603, A606, K606, M606, T606, A607, K607, A612, M612, A613, K616R, M616R, T616R, A618, K618, M618, A623, K623, and M623. Information on these boxes can be found in the Compartmented Box Section starting on page 20

Step 'N Store™ Stool

A cross between a tool box and a step stool, the Step 'N Store makes a great companion for tool portability and that often needed "little extra reach" on any job site.

- Engineered to support 300 pounds (136.08 kg)
- Heavy-duty riveted fold-down handle
- Lift-out center tray



22500-3

Model Number	Stock Number	Description inch (centimeter)	Dimensions (Inside, L x W x D)	Packed
22500-3	6759TC	Color: Safety Yellow Tray Dimensions (L x W x D) 14 x 8-1/4 x 1-5/8 (35.56 x 20.96 x 4.13)	15-1/2" x 9" x 7-1/2" (39.37 x 22.86 x 19.05 cm)	2/ctn

Expandable Tube

- Contoured, blow molded construction - won't bend, crush or break
- Hinged door makes it easy to load and unload
- Molded-in handle for maximum durability
- Completely lockable for added security
- Telescopes from 63" (160.02 cm) to 87" (220.99 cm) for maximum versatility



50077

Model Number	Stock Number	Description	Dimensions (Inside, L x W x D)	Packed
50077	50077	Color: Black, expandable tube	3-1/4" x 61-1/2" x 85-1/2" (8.26 x 156.21 x 217.17 cm)	1/ctn

NEW

SPECIALTY STORAGE: GUN CASES

Protective Gun Cases

These cases protect your guns from bumps & bruises while preventing unwanted trespassers into the case. The guns are blanketed with egg-shell foam padding, four locking points and piano style hinge to prevent opening during transport.

Economy Single Gun Case

- Largest economy single available
- Four locking points and piano style hinge
- keeps children out when properly locked
- Durable egg-shell foam

Patent #D498,052, #6,874,628



6470SK

Single Gun Case

- Four locking points for extra security
- Combination of piano style hinge and brass hinge provide durability, safety and protection
- Oversized single fits most scoped rifles
- Durable egg-shell foam

Patent #D498,052, #6,874,628



6489NK

Double Gun Case

- Four locking points for extra security
- Combination of piano style hinge and brass hinge provide durability, safety & protection
- Oversized double will accommodate two scoped rifles
- Durable egg-shell foam

Patent #D498,052, #6,874,628



6499NK

Pistol Pack Series

- Sliding, lockable latches
- Stackable
- Contemporary high profile design
- Full egg-shell foam



6776TC

6781TC

6785TE

10-1/2"

14"

17"

For Customer Service Inquiries Call 1-800-344-5716

SPECIALTY STORAGE

Utility Workstation™ Cart

A lot of thought went into the design of the Utility Workstation and, as a result, it is the most user friendly, most versatile cart on the market! Stress tested for weight up to 300 pounds (136.08 kg) you can easily integrate this cart into almost any application. Many other Flambeau products can be integrated into this Workstation to increase your organization & efficiency. Can be customized with your company name or logo. Assembles in less than 5 minutes!

- Locking tabs for lid
- Lockable lid compartment
- Sliding removable lid
- Drain plugs (each tray)
- Customizable (logo area)
- Bin Rail
- Heavy-duty locking casters - Holds up to 300 lbs (136.08 kg)
- Ergonomic handle with tool receiver

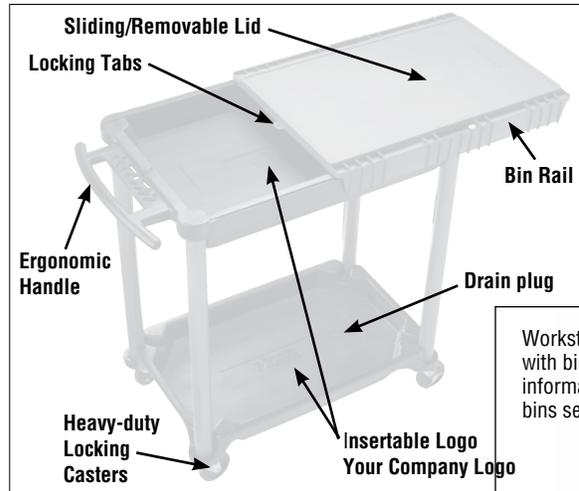

Interior Tray Dimensions:
25-1/2" x 18" x 3-5/25"
(64.77 x 45.72 x 8.13 cm)
Work Surface Dimensions:
28-1/2" x 7-1/2"
(72.39 x 44.45 cm)
Bottom Tray Dimensions:
20" x 17" x 3"
(50.80 x 43.18 x 7.62 cm)
Logo Area:
14" x 3-5/25" (35.56 x 8.13 cm)

Workstation shown with bins. For more information on the bins see below.



Model Number	Stock Number	Description	Dimensions (Overall, L x W x H)	Packed
8510ST	8510ST	Color: Two-Tone Gray	43" x 22" x 39" (109.22 x 55.55 x 99.06 cm)	1/ctn

Bin Storage Systems

Mix and match our four (4) sizes of bins to your liking. Our polypropylene bins are extra heavy-duty and can be stacked or wall-mounted with a rail. Our bins are impervious to rust, oil and most common chemicals.

- Locking rail (back of bin)
- Stackable
- Mountable
- Available in Conductive material **page 65**
- Use with Utility Workstation™ above

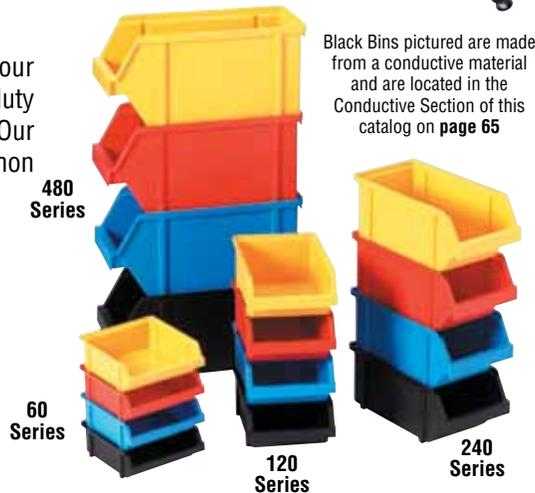

Bin Storage Bin Rail

Locking rail that attaches to the back of the bins.

- Sold separately



Model Number	Stock Number	Description	Dimensions (Inside, L x W x D)	Packed
60R 60B 60Y	6794RB 6794BB 6794YB	Red Blue Yellow	4-1/4" x 4" x 1-1/2" (10.80 x 10.16 x 3.81 cm)	24/ctn
120R 120B 120Y	6795RB 6795BB 6795YB	Red Blue Yellow	4-1/4" x 5" x 2-1/2" (10.80 x 12.70 x 6.35 cm)	24/ctn
240R 240B 240Y	6796RB 6796BB 6796YB	Red Blue Yellow	4-1/4" x 6-1/2" x 3-1/4" (10.80 x 16.51 x 8.26 cm)	12/ctn
480R 480B 480Y	6797RB 6797BB 6797YB	Red Blue Yellow	4-1/4" x 8-3/4" x 5-1/4" (10.80 x 22.23 x 13.34 cm)	12/ctn
351BA Ⓢ	6794BA	set includes: (16) 60Y, (24) 120R, (24) 240Y & (16) 480B	see each individual bin size	1/ctn
SR4	6796RL	Bin Rail holds 4 bins	19-1/2" long (49.53 cm long)	12/ctn

* Width is measured from back to front straight edge before flare out.

Rolling Tote Storage Cabinet **NEW**

The Rolling Tote is designed for light commercial parts storage and transport. Excellent for storing and transporting hand held tools; MRO items; or single unit storage for multiple uses. Features side extension pull handle with grip and lift out removable tray including lid stays. The large interior storage area, approx. 31" X 20" provides ample area to organize.

Dimensions

Inside: 30-1/2" x 19" x 19-1/4" (77.47 x 48.26 x 48.90 cm)

Outside: 31" x 19-1/4" x 19-1/2" (78.74 x 48.90 x 49.53 cm)

Packed: 1/ctn

Weight: 23.0 lbs per carton

Cu ft/carton: 6-3/4 (17.14)

6531BK



Utility Series – Industrial Grade

Flambeau Utility Series boxes are engineered tough. With thick wall construction and interior "I" beam support structures, you can expect the Utility Series boxes to out-perform most any other box! Features include: tongue-and-groove positive lid to base fit and heavy-duty riveted handles to handle even the heaviest load. Our positive cam-over latches and locking tabs give you added security. Finally, our heavy-duty cantilever trays are secured by rust-resistant hardware for extra longevity.

- Resistant to oil and common chemicals
- Dent-proof
- Scratch resistant
- Lockable
- Tip-Guard™ (cantilever trays only)
- Removable Interior Trays

Blow Molded Tool Boxes

Small Tool Box

- Lift-out tray sits on a "lip" at the top of the tool box base
- Tray size is larger than bottom dimension of tool box
- Available in red or black
- Has injection molded hardware
- Routed base for more storage space

Large Tool Box

- Lift-out tray sits on a "lip" at the top of the tool box base
- Tray size is larger than bottom dimension of tool box
- Available in red or black
- Has injection molded handle with large single integral latch
- Double wall construction for extra strength



50040
Open



50043
Open



50043

21470

50040

50042

Models	Lid Depth	Base Depth	Tray Dimensions
50040 & 50042	1-7/8" (4.76 cm)	2-13/16" (7.14 cm)	16-5/8" x 4-15/16" x 1-1/4" (42.23 x 12.54 x 3.18 cm)
21470 & 50043	3-1/2" (8.89 cm)	3-1/2" (8.89 cm)	19-1/2" x 8-9/16" x 1-3/4" (49.53 x 21.75 x 4.45 cm)

Model Number	Stock Number	Description inch (centimeter)	Dimensions (Inside, L x W x D)	Packed
50040	50040 21469Y140	Color: Red, Small tool box Outside* L x W x D = 15-5/8 x 4-15/16 x 4-11/16 (39.69 x 12.54 x 11.91)	15-1/2" x 4-3/4" x 4" (39.37 x 12.07 x 10.16 cm)	30/ctn
50042	50042 21470Y500	Color: Black, Small tool box Outside* L x W x D = 15-5/8 x 4-15/16 x 4-11/16 (39.69 x 12.54 x 11.91)	15-1/2" x 4-3/4" x 4" (39.37 x 12.07 x 10.16 cm)	30/ctn
21470	21470	Color: Red, Large tool box Outside* L x W x D = 19-7/8 x 8-5/16 x 7 (50.48 x 21.11 x 17.78)	18-1/4" x 7-1/2" x 5-3/4" (46.36 x 19.05 x 14.61 cm)	8/ctn
50043	50043 21470Y500	Color: Black, Large tool box Outside* L x W x D = 19-7/8 x 8-5/16 x 7 (50.48 x 21.11 x 17.78)	18-1/4" x 7-1/2" x 5-3/4" (46.36 x 19.05 x 14.61 cm)	8/ctn

*Includes lid overlap and hinges

TOOL BOXES

Utility Boxes

Flambeau Utility Boxes feature spacious open interiors and are manufactured from light-weight copolymer resins that are non-conductive, dent-proof, rust-proof and scratch-resistant.

- Brass hinge and latch pins & Tough recessed handles
- Positive action latches
- Models 1800 & 2100 have (2) 3/16" (2.06 cm) Lock Tabs
- Textured finish & Tongue-and-groove construction



Model Number	Stock Number	Description inch (centimeter)	Dimensions (Outside*, L x W x D)	Dimensions (Inside, L x W x D)	Packed
1100	6734UB	Color: Gray Lid Depth: 1-3/4 (4.45) Base Depth: 2-3/4 (6.99)	12-1/8" x 7-1/4" x 4-1/2" (30.80 x 18.42 x 11.43 cm)	11-1/8" x 5-3/4" x 4" (28.26 x 14.61 x 10.16 cm)	6/ctn
1200	6736UB	Color: Gray Lid Depth: 2-3/4 (6.99) Base Depth: 2-3/4 (6.99)	12-1/8" x 7-1/4" x 5-1/2" (30.80 x 18.42 x 13.97 cm)	11-1/8" x 5-3/4" x 5-1/4" (28.26 x 14.61 x 13.34 cm)	6/ctn
1400	6742UB	Color: Gray Lid Depth: 3-1/2 (8.89) Base Depth: 3-1/2 (8.89)	14-3/8" x 8" x 7" (36.51 x 20.32 x 17.78 cm)	13" x 6" x 6-1/4" (33.02 x 15.24 x 15.88 cm)	6/ctn
1700	6746UB	Color: Gray Lid Depth: 3-1/2 (8.89) Base Depth: 3-1/2 (8.89)	16-3/8" x 8-5/8" x 7" (41.59 x 21.91 x 17.78 cm)	15" x 6-3/4" x 6-1/2" (38.10 x 17.14 x 16.51 cm)	4/ctn
1800	6752UB	Color: Gray, has 3/16 (2.06) diameter lock tab Lid Depth: 4-1/4 (10.80) Base Depth: 4-1/4 (10.80)	17-1/2" x 10-1/4" x 8-1/2" (44.45 x 26.04 x 21.59 cm)	15-5/8" x 6-1/2" x 7-3/4" (39.69 x 16.51 x 19.69 cm)	4/ctn
2100	6760UB	Color: Gray, has 3/16 (2.06) diameter lock tab Lid Depth: 5-1/4 (13.34) Base Depth: 5-1/4 (13.34)	19" x 11-1/2" x 10-1/2" (48.26 x 29.21 x 26.67 cm)	17-1/8" x 8-5/8" x 9-1/4" (43.50 x 21.91 x 23.50 cm)	2/ctn

Utility/Tool Boxes with Lift-Out Trays and Lock Tabs - Trays not sold separately



Model Number	Stock Number	Description inch (centimeter)	Dimensions (Outside*, L x W x D)	Dimensions (Inside, L x W x D)	Packed
14800-2	6744HS	Color: Gray, has 3/16 (2.06) diameter lock tab Lid Depth: 1-1/2 (3.81) Base Depth: 3-1/2 (8.89) Tray (L x W x D): 12-1/4 x 4-3/4 x 1-1/2 (31.12 x 12.07 x 3.81)	14-1/2" x 7-1/2" x 5-1/4" (36.83 x 19.05 x 13.34 cm)	13" x 5-3/8" x 4-1/4" (33.02 x 13.65 x 10.80 cm)	6/ctn
17800-2	6748HS	Color: Gray, has 3/16 (2.06) diameter lock tab Lid Depth: 2-1/8 (5.40) Base Depth: 4-3/4 (12.07) Tray (L x W x D): 13-3/4 x 5-5/8 x 1-7/8 (34.93 x 14.29 x 4.76)	16-5/8" x 8-3/4" x 7-1/8" (42.23 x 22.23 x 18.10 cm)	14-1/2" x 6-1/8" x 6" (36.83 x 15.56 x 15.24 cm)	4/ctn
6518TH	6518TH	Color: Gray, has 1/4 (0.64) diameter molded lock tabs Lid Depth: 2 (5.08) Base Depth: 7 (17.78) Tray (L x W x D): 16 x 7-1/2 x 2 (40.64 x 19.05 x 5.08)	17" x 8-1/2" x 8-1/2" (43.20 x 20.40 x 20.40 cm)	16-1/4" x 7-3/4" x 7-3/4" (41.28 x 19.68 x 19.68 cm)	4/ctn
19800-2	6757HS	Color: Gray, has 3/16 (2.06) diameter lock tab Lid Depth: 2-3/8 (6.03) Base Depth: 7 (17.78) Tray (L x W x D): 17-5/8 x 6-3/8 x 2-3/16 (44.77 x 16.19 x 5.56)	20-1/4" x 8-7/8" x 8-3/8" (51.44 x 22.54 x 21.27 cm)	18-1/8" x 6-1/2" x 7-1/8" (46.36 x 16.51 x 18.10 cm)	4/ctn
19804	6757TY	Color: Yellow, has 3/16 (2.06) diameter lock tab Lid Depth: 2-3/8 (6.03) Base Depth: 7 (17.78) Tray (L x W x D): 17-5/8 x 6-3/8 x 2-3/16 (44.77 x 16.19 x 5.56)	20-1/4" x 8-7/8" x 8-3/8" (51.44 x 22.54 x 21.27 cm)	18-1/8" x 6-1/2" x 7-1/8" (46.36 x 16.51 x 18.10 cm)	4/ctn
6520TH	6520TH	Color: Gray, has two 1/4 (0.64) diameter molded lock tabs Lid Depth: 2 (5.08) Base Depth: 8 (20.32) Tray (L x W x D): 17-3/4 x 8 x 2 (45.09 x 20.32 x 5.08)	20" x 9-3/4" x 9-3/4" (50.80 x 24.80 x 24.80 cm)	17-1/4" x 9" x 9" (43.82 x 22.86 x 22.86 cm)	4/ctn
23800-2	6759HS	Color: Gray, has 3/16 (2.06) diameter lock tab Lid Depth: 2-1/2 (6.35) Base Depth: 8-3/8 (21.27) Tray (L x W x D): 20-5/8 x 7-1/2 x 2 (52.39 x 19.05 x 5.08)	23" x 10-1/2" x 11-3/8" (58.42 x 26.67 x 28.89 cm)	20-5/8" x 7-1/2" x 10" (52.39 x 19.05 x 25.40 cm)	2/ctn
27800-2	6754TC	Color: Gray, has 3/16 (2.06) diameter lock tab Lid Depth: 3-1/2 (8.89) Base Depth: 10-3/8 (26.35) Tray (L x W x D): 11-1/2 x 2-1/4 x 11 (29.21 x 5.72 x 27.94)	27-1/2" x 13-3/4" x 14" (69.85 x 35.93 x 35.56 cm)	23" x 12-1/2" x 12" (58.42 x 31.75 x 30.48 cm)	2/ctn

*Includes lid overlap and hinges

Utility Boxes with Cantilever Trays

Rugged Utility Boxes featuring Tip-Guard™ cantilever trays make it easy to organize tools and parts, repair kits, samples or sports equipment in a small space. Manufactured from light-weight copolymer resins that are dent-proof, rust-proof and scratch-resistant, these Utility Boxes are also resistant to oils and most common chemicals.

- Tough recessed handles
- Cantilever Tip-Guard tray supports
- Brass hinge and latch pins
- Positive-action latches
- Tongue-and-groove construction
- Trays are a light gray
- 3/16" (2.06 cm) diameter lock tab on models 18090-2 and 19060-2

2 Tray Boxes



17090-2

17090-2 Tray Configuration

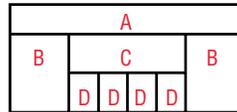

Top Tray (from front of box)



Bottom Tray (from front of box)



18090-2

18090-2 Tray Configuration

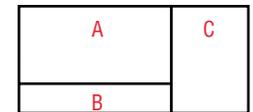

Top Tray (from front of box)



Bottom Tray (from front of box)

- 17090-2 Tray Compartments (Inside L x W x D)
- A= 14-1/4" x 1-7/8" x 1-5/16" (36.20 x 4.76 x 3.33 cm)
 - B= 3-1/2" x 3-3/16" x 1-5/16" (8.89 x 8.10 x 3.33 cm)
 - C= 7" x 1-7/8" x 1-5/16" (17.78 x 4.76 x 3.33 cm)
 - D= 1-11/16" x 1-7/8" x 1-5/16" (4.29 x 4.76 x 3.33 cm)
 - E= 6" x 5-3/4" x 1-5/16" (15.24 x 14.61 x 3.33 cm)
 - F= 4" x 5-3/4" x 1-5/16" (10.16 x 14.61 x 3.33 cm)

- 18090-2 Tray Compartments (Inside L x W x D)
- A= 9" x 7" x 1-3/4" (22.86 x 17.78 x 4.45 cm)
 - B= 9" x 2-1/4" x 1-3/4" (22.86 x 5.72 x 4.45 cm)
 - C= 5-1/2" x 7" x 1-3/4" (13.97 x 17.78 x 4.45 cm)
 - D= 2-7/16" x 7" x 1-3/4" (6.19 x 17.78 x 4.45 cm)
 - E= 6-1/4" x 7" x 1-3/4" (15.88 x 17.78 x 4.45 cm)

Model Number	Stock Number	Description inch (centimeter)	Dimensions (Outside*, L x W x D)	Dimensions (Inside, L x W x D)	Packed
17090-2	6749HS	Color: Gray, 2 cantilever trays, 11 compartments Lid Depth: 3-1/2 (8.89) Base Depth: 3-1/2 (8.89)	16-3/8" x 8-5/8" x 7" (41.59 x 21.91 x 17.78 cm)	15" x 6-3/4" x 6-1/2" (38.10 x 17.15 x 16.51 cm)	4/ctn
18090-2	6755HS	Color: Gray, 2 cantilever trays, 8 compartments Lid Depth: 4-1/4 (10.80) Base Depth: 4-1/4 (10.80)	17-1/2" x 10-1/4" x 8-1/2" (44.45 x 26.04 x 21.59 cm)	15-5/8" x 6-1/2" x 7-3/4" (39.69 x 16.51 x 19.69 cm)	4/ctn

6 Tray Box



19060-2

19060-2 Tray Configuration

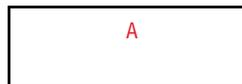

Top Tray - Right Bank (from front of box)



Middle Tray - Right Bank (from front of box)



Bottom Tray - Right Bank (from front of box)



Top Tray - Left Bank (from front of box)



Middle Tray - Left Bank (from front of box)



Bottom Tray - Left Bank (from front of box)

- 19060-2 Tray Compartments (Inside L x W x D)
- A= 14-1/2" x 2-3/4" x 1" (36.83 x 6.99 x 2.54 cm)
 - B= 1-3/4" x 2-3/4" x 1" (4.45 x 6.99 x 2.54 cm)
 - C= 1-7/8" x 2-7/8" x 1-5/16" (4.76 x 7.30 x 3.33 cm)

- D= Slant divider wall 12-1/2" x 1-5/8" & 2-3/8" x 1-5/16" (31.75 x 4.13 & 6.03 x 3.33 cm)
- E= 14-1/2" x 1-3/8" x 1-5/16" (36.83 x 3.49 x 3.33 cm)
- F= 1-1/2" x 4-3/8" x 1-5/16" (3.81 x 11.11 x 3.33 cm)
- G= 8-1/8" x 4-3/8" x 1-5/16" (20.64 x 11.11 x 3.33 cm)

Model Number	Stock Number	Description inch (centimeter)	Dimensions (Outside*, L x W x D)	Dimensions (Inside, L x W x D)	Packed
19060-2	6756HS	Color: Gray, 6 cantilever trays, 35 compartments Lid Depth: 4-3/4 (12.07) Base Depth: 4 (10.16)	18-1/2" x 10-3/4" x 10-3/8" (46.99 x 27.31 x 26.35 cm)	15-1/2" x 7-1/4" x 8-1/2" (39.37 x 18.42 x 21.59 cm)	1/ctn

*Includes lid overlap and hinges

TOOL BOXES

Low Boy™ Tool Box

This low profile tool box has an ergonomic handle and is manufactured from light-weight copolymer resins that are non-conductive, dent-proof, rust-proof & scratch-resistant.

- Spacious 17" x 10-1/2" x 3-5/8" (43.18 x 26.67 x 9.21 cm) interior
- Stand-alone tool box does not accommodate expansion kit.



18192-2

Model Number	Stock Number	Description	Dimensions (Outside*, L x W x D)	Dimensions (Inside, L x W x D)	Packed
18192-2	6735HS	Color: Yellow	18-1/2" x 12-1/2" x 6" (46.99 x 31.75 x 15.24 cm)	17" x 10-1/2" x 3-5/8" (43.18 x 26.67 x 9.21 cm)	4/ctn

Expandable Building Box

Manufactured from light-weight copolymer resins that are non-conductive, dent-proof, rust-proof & scratch-resistant.

- Ergonomic handle
- Spacious 17" x 10-1/2" x 3-5/8" (43.18 x 26.67 x 9.21 cm) top interior
- Includes (2), 999-2 Infinite Divider System™ Boxes
- Additional trays available with Expansion Kit



13901-2



999-2 Inside Dimensions (L x W x D)
13-1/8" x 8-7/8" x 1-15/16"
(33.34 x 22.54 x 4.92 cm)



13900-2

Model Number	Stock Number	Description	Dimensions (Outside*, L x W x D)	Dimensions (Inside, L x W x D)	Packed
13900-2	6730HS	Colors: Yellow and Black	18-1/2" x 12-1/2" x 11-3/4" (46.99 x 31.75 x 28.85 cm)	18" x 11" x 3-1/2" (45.72 x 27.94 x 8.89 cm)	4/ctn
13901-2	6731HS	Expansion Kit, Color: Black	16-3/16" x 10-1/16" x 3-1/4" (41.12 x 25.56 x 8.26 cm)	13-1/2" x 9-1/4" x 2-3/4" (34.29 x 23.50 x 6.99 cm)	6/ctn

Versatile Utility Tool Box

This Kwik-Change Series tool box comes complete with a large, bulk storage area with removable small tool and fastener organization. Features interchangeable Tuff Tainer® storage to allow for "quick-changes", depending on the job and supplies needed. Exterior rack on each side for quick access to frequently-used tools.

- Heavy-duty, fold-down handle and cam-over latches
- Bulk storage beneath lid
- Bulk capacity featuring interchangeable Tuff Tainer® Boxes
- Includes (3) T4007E, and (2) T1002 removable Tuff Tainer* Boxes

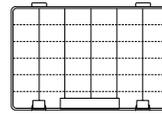

(3) T4007E



(2) T1002

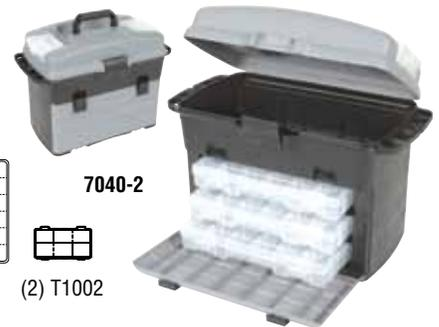

7040-2

* Tuff Tainers are adjustable compartmented boxes; for dimensions of T4007E (Ref. page 16), and T1002 (Ref. page 14).

Model Number	Stock Number	Description	Bulk Storage (L x W x D)	Dimensions (Outside*, L x W x D)	Packed
7040-2	6767HS	Color: Black/Gray	14" x 8" x 4" (35.56 x 20.32 x 10.16 cm)	14" x 8-1/2" x 3-1/4" (35.56 x 21.59 x 8.26 cm)	2/ctn

Tailgator™

- Removable dividers allow items to be stored upright
- Prop-rod holds lid upright for easy access
- Handle on each side allows Tailgator to be moved easily
- Two large Power Latches™ hold Tailgator's lid securely in place
- Lockable
- Removable floor panel can lock in place or side-to-side for easy access
- Strong construction allows stacking on top
- Front panel opens independently
- Removable lid doubles as a tabletop



38000



Model Number	Stock Number	Description	Dimensions (Inside, L x W x D)	Packed
38000	6542TG	Color: Taupe	35-3/4" x 16-3/4" x 10-1/4" (90.81 x 42.55 x 26.04 cm)	1/ctn

Flambeau Packaging Solutions Gear Boxes - Whether hauling it, protecting it, or storing it, these Gear Boxes do it all!

Flambeau offers two sizes of Gear Boxes – the T1408B with a 13" (33.02 cm) interior length and the T1418 with a 17-1/2" (44.45 cm) interior length. Both are perfect for a variety of uses, with features like a deep open interior, snap-open lid, lift-out tray, oversized handle and latch. These Gear Boxes are perfect for Medical Supplies, Safety Equipment, Automotive Repair Kits, Test Equipment, Toys, Art Supplies, Maintenance & Repair Supplies, Gaming, Industrial Supplies, Firearm Supplies and much more.

Features

- Deep open interior
- Gasket in lid
- Cam-over latch design
- Large carry handle
- Tongue-and-groove design
- Snap-open lid with storage
- Lift-out tray
- Lockable

Benefits

- Accommodates large, tall parts and equipment
- Keeps contents dry and protected in extreme environments
- Provides added strength
- Better ergonomics makes hauling easier
- Helps keep dust and contaminants out
- Perfect for storing small parts
- Keeps everything organized and at your fingertips
- Secures contents in main compartment



T1408B

Top compartment "U" shaped 1" (2.54 cm) Deep



T1418

Top compartment "U" shaped 1-1/4" (3.18 cm) Deep



All models include a 360° gasket in the lid which keeps contents dry and protected from some of the most extreme environments.



As an option, both sizes can be molded in Zerust® Corrosion Inhibitor creating an invisible barrier to fight against corrosion.



Both sizes available in custom colors contact Customer Service for more information.

Model Number	Stock Number	Description inch (centimeter)	Tray Dimensions (L x W x D)	Dimensions (Inside, L x W x D)	Packed
T1408B	6430TD	Color: Black with Lift-Out Tray Inside Box Clearance Under Tray is 5-1/4 (13.33)	12-3/4" x 6-1/2" x 2" (32.39 x 16.51 x 5.08 cm)	13" x 6-3/4" x 7-1/4" (33.02 x 17.15 x 18.42 cm)	4/ctn
T1418	6917GB	Color: Black with Lift-Out Tray Inside Box Clearance Under Tray is 7 (17.78)	13-1/4" x 8-1/4" x 2-3/4" (33.66 x 20.96 x 6.99 cm)	17-1/2" x 10-1/2" x 12" (44.45 x 26.67 x 30.48 cm)	2/ctn

TOOL BOXES

Lil' Brute™ Utility/Tool Box

The Lil' Brute Utility Tool Box is redesigned! New added features include upgraded Super Satchel style handle with new L-089 "quick-snap" latches. Available with or without lift out tray! Customize with colors or hot stamp options. A fantastic value!

- Available with or without trays - trays not sold separately

*Includes lid overlap and hinges



Model Number	Stock Number	Description inch (centimeter)	Dimensions (Outside*, L x W x D)	Dimensions (Inside, L x W x D)	Packed
13805-2	6743HS	Color: Black, with tray (L x W x D) 12 x 4-3/8 x 1 (30.48 x 11.11 x 2.54) Lid Depth: 1/2" (1.27), Base Depth: 4-1/4 (10.80)	13" x 6" x 5-3/8" (33.02 x 15.24 x 13.65 cm)	12" x 4-3/4" x 4-3/4" (30.48 x 12.07 x 12.07 cm)	6/ctn
13815-2	6742HS	Color: Black, without tray	13" x 6" x 5-3/8" (33.02 x 15.24 x 13.65 cm)	12" x 4-3/4" x 4-3/4" (30.48 x 12.07 x 12.07 cm)	6/ctn

Utility Tote

- Copolymer resins resist scratching, fading and rusting
- Has a large built-in handle and pull-out tray on bottom can be opened from either side
- Ideal for service areas or vehicles
- Drawer with 12 compartments & dimensions of 13-3/4" x 9" x 1-1/2" (34.93 x 22.86 x 3.81 cm)

16500-2



Model Number	Stock Number	Description	Dimensions (Outside, L x W x D)	Dimensions (Inside, L x W x D)	Packed
16500-2	6769HS	Color: Black, with light gray drawer	16-5/8" x 10-1/4" x 6-7/8" (42.23 x 26.04 x 17.46 cm)	13-3/4" x 9" x 4" (34.93 x 22.86 x 10.16 cm)	6/ctn

Utility Bench Box

- Spacious 20" x 8" x 4" (50.8 x 20.32 x 10.16 cm) top
- Two large pull-out drawers with 2 compartments in drawer one & 2 compartments in drawer two
- Drawer dimensions are 18-3/8" x 5-7/8" x 1-7/8" (46.67 x 14.92 x 4.76 cm)
- Drawers can be secured from accidental opening
- Includes two (2) removable dividers for each drawer
- Fold-down handle

*Includes lid overlap and hinges

21800-2



Model Number	Stock Number	Description	Dimensions (Outside, L x W x D)	Dimensions (Inside, L x W x D)	Packed
21800-2	6758HS	Color: Black, with 2 light gray drawers	21-3/4" x 10-3/4" x 9-3/8" (55.25 x 27.31 x 23.81 cm)	20" x 8" x 4" (50.80 x 20.32 x 10.16 cm)	1/ctn

Tool Chests

Flambeau Tool Chests are also designed to organize, store and protect precision tools, hardware and small parts. They feature a unique front panel design that allows drawer access when the front panel is down. A unique lock prevents accidental spills and allows the lid and drawers to lift as a unit, providing access to the large lower storage area.

- Molded in high-impact resins
- Resistant to most common chemicals, solvents and oils
- Positive-action latches
- Lockable
- Brass hinges and latch pins
- Light gray interchangeable drawers with adjustable compartment sizes
- Model 22030-2 is molded in industrial-grade ABS plastic



For Drawer Dimensions and Compartment Dimensions, Please See Below.

Model Number	Stock Number	Description	Drawer Configuration	Dimensions (Outside, L x W x D)	Packed
22030-2	6759CH	Color: Gray with light gray drawers	(2) B & (1) F	19-1/2" x 11-1/2" x 11-3/4" (49.53 x 29.21 x 29.85 cm)	1/ctn

Drawer Cabinets

Flambeau Drawer Cabinets are designed to organize, store and protect precision tools, hardware and small parts. They feature a self-storing door panel providing all-weather protection for the contents inside.

- Molded in industrial grade ABS plastic
- Resistant to most common chemicals, solvents and oils
- Positive-action latches
- Lockable
- Brass hinges and latch pins
- Light gray interchangeable drawers with adjustable compartment sizes, see below for drawer details



Model Number	Stock Number	Description	Drawer Configuration	Dimensions (Outside, L x W x D)	Packed
22060	6596DH	Color: Gray with light gray drawers	(4) B, (1) C & (1) F	19-1/2" x 11-1/2" x 11-3/4" (49.53 x 29.21 x 29.85 cm)	1/ctn
2275-2	6763DB	Color: Gray with light gray drawers	(2) B, (2) D & (1) E	19-1/2" x 10-3/8" x 15" (49.53 x 26.35 x 38.10 cm)	1/ctn
2276-2 (not shown)	6764DB	Color: Gray with light gray drawers	(1) A, (3) B, (1) C & (1) D	19-1/2" x 10-3/8" x 15" (49.53 x 26.35 x 38.10 cm)	1/ctn
2277-2	6765DB	Color: Gray with light gray drawers	(1) A, (2) B & (4) D	19-1/2" x 10-3/8" x 15" (49.53 x 26.35 x 38.10 cm)	1/ctn

Drawer Cabinets & Tool Chests Drawer Dimensions

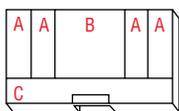

Drawer A - #AR839-45 - inches (centimeters)
 Overall L x W x D: 15-9/16 x 8-13/16 x 1-3/8 (39.53 x 22.84 x 3.49)
 Compartments L x W x D
 A= 1-15/16 x 6-3/16 x 1-1/4 (4.92 x 15.72 x 3.18)
 B= 7-5/16 x 6-3/16 x 1-1/4 (18.57 x 15.72 x 3.18)
 C= 15-1/8 x 2-7/16 x 1-1/4 (5.08 x 7.94 x 3.18)

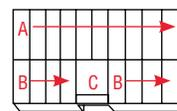

Drawer D - #AR840-45 - inches (centimeters)
 Overall L x W x D: 15-9/16 x 8-13/16 x 1-3/8 (39.53 x 22.84 x 3.49)
 Compartments L x W x D
 A= 1-3/8 x 5-1/16 x 1-1/4 (3.49 x 12.86 x 3.18)
 B= 1-3/8 x 3-9/16 x 1-1/4 (3.49 x 9.05 x 3.18)
 C= 3-3/16 x 3-9/16 x 1-1/4 (8.10 x 9.05 x 3.18)

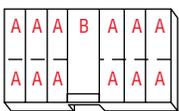

Drawer B - #AR841-45 - inches (centimeters)
 Overall L x W x D: 15-9/16 x 8-13/16 x 1-3/8 (39.53 x 22.84 x 3.49)
 Compartments L x W x D
 A= 1-15/16 x 4-1/2 x 1-1/4 (4.92 x 11.43 x 3.18)
 B= 3-3/16 x 8-7/8 x 1-1/4 (8.10 x 22.54 x 3.18)



Drawer E - #AR928-45 - inches (centimeters)
 Overall L x W x D: 15-9/16 x 8-13/16 x 4-7/16 (39.53 x 22.84 x 11.27)
 Compartment L x W x D
 A= 15-1/8 x 8-5/8 x 4-5/16 (38.42 x 21.91 x 10.95)

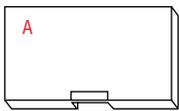

Drawer C - #AR869-45 - inches (centimeters)
 Overall L x W x D: 15-9/16 x 8-13/16 x 2-7/8 (39.53 x 22.84 x 7.30)
 Compartment L x W x D
 A= 15-1/8 x 8-5/8 x 2-5/8 (38.42 x 21.91 x 6.67)

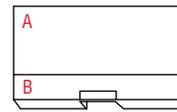

Drawer F - #AR897-45 - inches (centimeters)
 Overall L x W x D: 15-9/16 x 8-13/16 x 1-3/8 (39.53 x 22.84 x 3.49)
 Compartments L x W x D
 A= 15-1/8 x 6-3/16 x 1-1/4 (38.42 x 15.72 x 3.18)
 B= 15-1/8 x 2-7/16 x 1-1/4 (38.42 x 6.19 x 3.18)

Drawer Cabinets & Tool Chests Replacement Drawer Packs

Each replacement drawer pack includes 6 drawers.

Model Number	Stock Number	Description	Packed
AR839-45	6073DP	Drawer A	6/pk
AR841-45	6069DP	Drawer B	6/pk
AR869-45	6071DP	Drawer C	6/pk
AR840-45	6072DP	Drawer D	6/pk
AR928-45	6060DP	Drawer E	6/pk
AR897-45	6070DP	Drawer F	6/pk

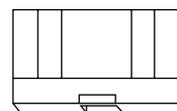

Drawer A
 L= 15-9/16" (39.53 cm)
 W= 8-13/16" (22.84 cm)
 D= 1-3/8" (3.49 cm)

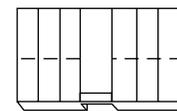

Drawer B
 L= 15-9/16" (39.53 cm)
 W= 8-13/16" (22.84 cm)
 D= 1-3/8" (3.49 cm)

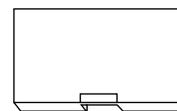

Drawer C
 L= 15-9/16" (39.53 cm)
 W= 8-13/16" (22.84 cm)
 D= 2-7/8" (7.30 cm)

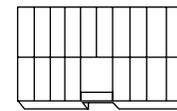

Drawer D
 L= 15-9/16" (39.53 cm)
 W= 8-13/16" (22.84 cm)
 D= 1-3/8" (3.49 cm)

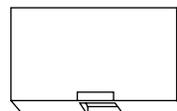

Drawer E
 L= 15-9/16" (39.53 cm)
 W= 8-13/16" (22.84 cm)
 D= 4-7/16" (11.27 cm)

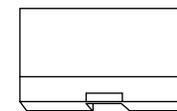

Drawer F
 L= 15-9/16" (39.53 cm)
 W= 8-13/16" (22.84 cm)
 D= 1-3/8" (3.49 cm)

Dimensions Listed are Overall Dimensions

MEDICAL

Maximum Versatility - Built to Last

Our extensive line of medical boxes and cases are the most durable in the field. Constructed of copolymer resins, our medical line is light-weight, rust-proof, scratch- and chemical-resistant. Flambeau medical cases, chests, and instrument boxes are built to last with extra thick walls for long-lasting durability and impact resistance. Used by EMS personnel, rescue, first-responders, trainers, triage staff and other respected medical professionals around the globe, our variety of products will meet your needs in most any application.

Features

- Thick-wall Construction
 - Maximum Physical Protection
- Locking Tabs (select items)
- Positive Contact Cam-over Latches
- Rust-proof Hinges
- Heavy-duty Cantilever Drawer Stays
- Heavy-duty Riveted Fold-down Handles
- Autoclave Safe (select items)

Medical Device Box

Store, transport, and protect cardiac implant devices and most other small wafer type implantable devices. Sterilize with ETO; Gamma; or E-Beam process. Made of tough Polypropylene material. Box can be easily customized with logo or name plate.

- Lid top fits over base



Model Number	Stock Number	Description inch (centimeter)	Tray Dimensions (L x W x D)	Dimensions (Inside, L x W x D)	Packed
6528MD	6528MD	Color: Natural	5-3/10" x 5-3/10" x 1-1/2" (13.46 x 13.46 x 3.81 cm)	5-3/10" x 5-3/10" x 1-1/2" (13.46 x 13.46 x 3.81 cm)	24/ctn

Paramedic Gear Box - Water-resistant

Light-weight, rust-proof, scratch- and chemical-resistant and lockable! The Gear Box features a 360° water-resistant rubber lid seal with an easy access heavy-duty cam-over latch so you can be sure that your contents will be secure and protected from adverse weather conditions.

- Lockable with a heavy-duty large comfort handle
- Top compartment "U" shaped 1" (2.54 cm) deep
- Positive-touch, double-latch system (top storage area)
- Lift-out tray has a center handle - Additional 3/4" (1.91 cm) above tray under lid



Model Number	Stock Number	Description inch (centimeter)	Tray Dimensions (L x W x D)	Dimensions (Inside, L x W x D)	Packed
PM1408	6430PM	Color: Orange with Lift-Out Tray Inside Box Clearance Under Tray is 5-1/4" (13.33)	12-3/4" x 6-1/2" x 2" (32.39 x 16.51 x 5.08 cm)	13" x 6-3/4" x 7-1/4" (33.02 x 17.15 x 18.42 cm)	4/ctn

Paramedic Case

Our most complete Paramedic cases yet! These cases combine bulk storage with compartmentalization to give you the convenience and flexibility you need.

PM8040 - Heavy-duty fold-down handle

- Includes (4) 6004R, and (2) T2003 removable, Tuff Tainer™ * boxes
- Interior slotted to hold up to (3) additional removable, T2003 Tuff Tainer™ * boxes



* Tuff Tainers are adjustable compartmented boxes; for dimensions of T2003 (Ref. page 14), T6004 (Ref. page 16), T4007E (Ref. page 16), T4000 (Ref. page 16), and T1002 (Ref. page 14).

Model Number	Stock Number	Description	Bulk Storage (L x W x D)	Dimensions (Inside, L x W x D)	Packed
PM7040	6049PM	Color: Orange	14" x 8" x 4" (35.56 x 20.32 x 10.16 cm)	14" x 8-1/2" x 3-1/4" (35.56 x 21.59 x 8.26 cm)	2/ctn
PM8040	6778PM	Color: Orange	18" x 11" x 4" (45.72 x 27.94 x 10.16 cm)	17" x 11" x 3-1/2" (43.18 x 27.94 x 8.89 cm)	2/ctn

First Aid Cases



Model Number	Stock Number	Description	Tray(s) Dimensions (L x W x D)	Dimensions (Inside, L x W x D)	Packed
PM1702	6768PM	Color: Orange with white tray 1 compartment and removable tray	14-3/8" x 6-5/8" x 2" (36.51 x 16.83 x 5.08 cm)	15" x 6-3/4" x 6-1/2" (38.10 x 17.14 x 16.51 cm)	4/ctn
PM1772	6770PM	Color: Orange with white trays 2 tip-proof cantilever trays, 8 large compartments	14-1/4" x 5-3/4" x 1-3/8" (36.20 x 14.61 x 3.49 cm)	15" x 6-3/4" x 6-1/2" (38.10 x 17.14 x 16.51 cm)	4/ctn
PM1872	6772PM	Color: Orange with white trays 2 tip-proof cantilever trays, 8 large compartments	14-3/4" x 7-1/8" x 1-3/4" (37.47 x 18.10 x 4.45 cm)	15-5/8" x 6-1/2" x 7-3/4" (39.69 x 16.51 x 19.69 cm)	4/ctn

Paramedic Box

The standard in emergency care cases.

- Lockable
- Heavy-duty trays - Riveted cantilever rust-resistant hardware



Model Number	Stock Number	Description	Tray(s) Dimensions (L x W x D)	Dimensions (Inside, L x W x D)	Packed
PM2072	6774PM	Color: Orange with white trays 2 tip-proof cantilever trays, 10 compartments	16-3/8" x 7-3/8" x 2" (41.59 x 18.73 x 5.08 cm)	17-1/8" x 9-1/2" x 5" (43.50 x 24.13 x 12.70 cm)	1/ctn

Instrument Boxes

Ideal for small or delicate equipment.

- Integral hinge
- Positive latch
- Durable polypropylene construction
- Safe for autoclaving



Model Number	Stock Number	Description	Dimensions (Inside, L x W x D)	Packed
V301	6142VB	Color: Orange, 1 Compartment with hanging tab	7" x 3-1/4" x 1" (17.78 x 8.26 x 2.54 cm)	36/ctn
V301PT	6650VC	Color: Taupe, 1 Compartment	7" x 3-1/4" x 1" (17.78 x 8.26 x 2.54 cm)	36/ctn
V401	6152VB	Color: Taupe, 1 Compartment	8-1/8" x 4-1/8" x 1-3/16" (20.64 x 10.48 x 3.02 cm)	24/ctn
V401D-2	6654DV	Color: Taupe, Deep, 1 Compartment	8-1/8" x 4-1/8" x 2-5/8" (20.64 x 10.48 x 6.67 cm)	24/ctn
V501	6160VB	Color: Taupe, 1 Compartment	10" x 4-1/4" x 1-1/2" (25.40 x 10.80 x 3.81 cm)	24/ctn
V601	6667VB	Color: Taupe, 1 Compartment	13-1/2" x 5-3/4" x 2" (34.29 x 14.61 x 5.08 cm)	12/ctn
V701	6172VB	Color: Taupe, 1 Compartment	17" x 7-1/8" x 2" (43.18 x 18.10 x 5.08 cm)	6/ctn

MEDICAL

Command Center Box

Excellent for bulk storage. With two built-in handles on each end, this box gives you the flexibility and ease of quick transport from your rig to the scene. This box is durable, but light-weight and has become a favorite!

- Lockable with 2 power latches



PM27800

Model Number	Stock Number	Description	Removable Interior Tray Dimensions (L x W x D)	Dimensions (Inside, L x W x D)	Packed
PM27800	6754PM	Color: Orange	12" x 11-3/4" x 2" (30.48 x 29.85 x 5.08 cm)	23" x 12-1/2" x 12" (58.42 x 31.75 x 30.48 cm)	2/ctn

Trauma Drug Kits

Our trauma drug kits have a drop-front panel for easy access to the storage bin below, a positive cam-over latch, and are lockable for protection of contents. The ABS drawers can be sterilized. All drawers are removable and interchangeable. See *Drawer Configuration in table for drawers included with the PM2272 and PM2273.*



PM2272



Closed view of models PM2272 and PM2273



PM2273

Model Number	Stock Number	Description	Drawer Configuration	Dimensions (Inside, L x W x D)	Packed
PM2272	6776PM	Color: Orange with White Drawers, 8-14 compts.	(1) B & (1) C	17-3/8" x 9-3/4" x 5" (44.13 x 24.77 x 12.70 cm)	1/ctn
PM2273	6777PM	Color: Orange with White Drawers, 21-39 compts.	(3) B	17-3/8" x 9-3/4" x 5" (44.13 x 24.77 x 12.70 cm)	1/ctn

Drawer Cabinets

Our drawer cabinets have a front panel that easily drops down for use of all drawers, a positive cam-over latch, and are lockable for protection of contents. The ABS drawers can be sterilized. All drawers are removable and interchangeable. See *Drawer Configuration in table for drawers included with the PM2274 and PM2275.*



PM2274

closed view



PM2275

closed view

Model Number	Stock Number	Description	Drawer Configuration	Dimensions (Outside, L x W x D)	Packed
PM2274	6762PM	Color: Orange with White Drawers, 27 compts.	(1) A, (1) C, (1) D & (1) E	19-1/2" x 10-3/8" x 15" (49.53 x 26.35 x 38.10 cm)	1/ctn
PM2275	6763PM	Color: Orange with White Drawers, 53-65 compts.	(2) B, (2) D & (1) E	19-1/2" x 10-3/8" x 15" (49.53 x 26.35 x 38.10 cm)	1/ctn

Trauma Drug Kits & Drawer Cabinets Drawer Dimensions

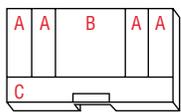

Drawer A - #AR839-10 - inches (centimeters)
Overall L x W x D: 15-9/16 x 8-13/16 x 1-3/8 (39.53 x 22.84 x 3.49)
Compartments L x W x D
A= 1-15/16 x 6-3/16 x 1-1/4 (4.92 x 15.72 x 3.18)
B= 7-5/16 x 6-3/16 x 1-1/4 (18.57 x 15.72 x 3.18)
C= 15-1/8 x 2-7/16 x 1-1/4 (5.08 x 7.94 x 3.18)

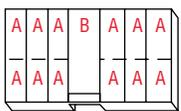

Drawer B - #AR841-10 - inches (centimeters)
Overall L x W x D: 15-9/16 x 8-13/16 x 1-3/8 (39.53 x 22.84 x 3.49)
Compartments L x W x D
A= 1-15/16 x 4-1/2 x 1-1/4 (4.92 x 11.43 x 3.18)
B= 3-3/16 x 8-7/8 x 1-1/4 (8.10 x 22.54 x 3.18)



Drawer C - #AR869-10 - inches (centimeters)
Overall L x W x D: 15-9/16 x 8-13/16 x 2-7/8 (39.53 x 22.84 x 7.30)
Compartment L x W x D
A= 15-1/8 x 8-5/8 x 2-5/8 (38.42 x 21.91 x 6.67)

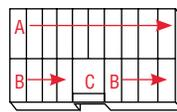

Drawer D - #AR840-10 - inches (centimeters)
Overall L x W x D: 15-9/16 x 8-13/16 x 1-3/8 (39.53 x 22.84 x 3.49)
Compartments L x W x D
A= 1-3/8 x 5-1/16 x 1-1/4 (3.49 x 12.86 x 3.18)
B= 1-3/8 x 3-9/16 x 1-1/4 (3.49 x 9.05 x 3.18)
C= 3-3/16 x 3-9/16 x 1-1/4 (8.10 x 9.05 x 3.18)



Drawer E - #AR928-10 - inches (centimeters)
Overall L x W x D: 15-9/16 x 8-13/16 x 4-7/16 (39.53 x 22.84 x 11.27)
Compartment L x W x D
A= 15-1/8 x 8-5/8 x 4-5/16 (38.42 x 21.91 x 10.95)

To order replacement drawers, please call Customer Service at 1-800-344-5716. Be sure to give them the Drawer letter (A, B, etc.) and number listed after "#" in this section for easier ordering.

Guard Against Expensive Damage

A leader in the industry, Flambeau's reusable conductive product line significantly reduces electrical resistance and provides an extremely high permanent level of conductivity to dissipate static charge buildup, alleviating electrostatic discharge (ESD). Our proprietary blend of carbon loaded HDPE materials are a guarantee that Flambeau conductive products will protect the most sensitive equipment and perform in the harshest environment.

Technical Data

- Surface Resistivity 10^{10} - 10^{11} (ASTM D 257 / ESD S11.11)
- Static Decay <2.0 Seconds (MIL-PRF-81705D)

Features

- Double-wall Construction - Maximum Physical Protection
- Locking Tabs (select items)
- Reusable & Stackable
- Secure Positive, Integral Double Latches
- ESD Protection
- Permanently Anti-Static

Conductive Cases

Options:

- Clear Conductive Window (Special order styles only)
 - Easy part identification without compromise of Faraday Cage protection
- Grounding Snap
 - Reduces surface charges so the case can be safely opened without damaging contents
- Antistatic or Conductive Foam
 - (Conductive quoted separately)
 - (Antistatic included upon request, foam is glued into case)
 - Provides physical shock resistance, reduces the potential for static build-up and arc potential due to the low friction coefficient of the foam



Model Number	Stock Number	Description	Dimensions (Inside, L x W x D**) *B = Base; L = Lid **Depth = Base + Lid	Packed
50019	50019 21460	5 x 3 Conductive Case	5-1/16" x 2-3/4" B*, 2-5/8" L* x 1" (13.49 x 6.99 B*, 6.67 L* x 2.54 cm)	341/ctn
21463	21463	6 x 5 Conductive Case	6-3/4" B*, 6-1/2" L* x 5" B*, 4-3/4" L* x 1-3/16" (17.15 B*, 16.51 L* x 12.70 B*, 12.07 L* x 3.02 cm)	135/ctn
50014	50014	9 x 7 Conductive Case with wire tie feature	8-15/16" B*, 9-1/16" L* x 6-5/8" B*, 6-1/2" L* x 1-1/4" (22.70 B*, 23.02 L* x 16.83 B*, 16.51 L* x 3.18 cm)	96/ctn
50015	50015	12 x 8 Conductive Case with wire tie feature	11-7/8" B*, 11-15/16" L* x 8-3/16" B*, 8-7/16" L* x 1-1/4" (30.16 B*, 30.32 L* x 20.80 B*, 21.43 L* x 3.18 cm)	54/ctn
21458	21458	13 x 11 Conductive Case with wire tie feature	12-3/4" x 10-1/2" x 1-3/4" (32.39 x 26.67 x 4.45 cm)	30/ctn
21459	21459	15 x 6 Conductive Case	15" x 6-1/2" x 2" (38.10 x 16.51 x 5.08 cm)	24/ctn
21462	21462	18 x 14 Conductive Case with wire tie feature	17-1/2" x 13-1/2" x 1-5/16" (44.45 x 34.29 x 3.33 cm)	7/ctn
21461	21461	18 x 18 Conductive Case with wire tie feature	18-7/16" x 17-11/16" x 1-15/16" (46.83 x 44.93 x 4.92 cm)	10/ctn

CONDUCTIVE PRODUCTS

Conductive Tool Box

- 14" (35.56 cm) Storage Box with full-length tray



14800-2C

Model Number	Stock Number	Description	Tray Dimensions (L x W x D)	Dimensions (Inside, L x W x D)	Packed
14800-2C	6744HC	Color: Black	12-1/4" x 4-3/4" x 1-1/2" (31.12 x 12.07 x 3.81 cm)	13" x 5-3/8" x 4-1/4" (33.02 x 13.65 x 10.80 cm)	6/ctn

600/800 Series Conductive Boxes



C601

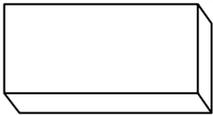

C618

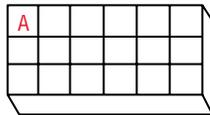

Compartments (L x W)
A= 2-1/16" x 1-3/4" (5.24 x 4.45 cm)



C801

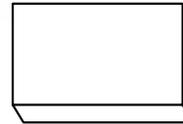

C824

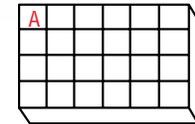

Compartments (L x W)
A= 2-1/16" x 2-1/16" (5.24 x 5.24 cm)

Model Number	Stock Number	Description	Dimensions (Inside, L x W x D)	Packed
C601	6707TC	1 compartment	10-1/2" x 6-3/16" x 1-9/16" (26.67 x 15.72 x 3.97 cm)	24/ctn
C618	6714TC	18 compartments	10-1/2" x 6-3/16" x 1-9/16" (26.67 x 15.72 x 3.97 cm)	24/ctn
C801	6734TC	1 compartment	12-3/4" x 8-1/2" x 2-1/8" (32.39 x 21.59 x 5.40 cm)	12/ctn
C824	6726TC	24 compartments	12-3/4" x 8-1/2" x 2-1/8" (32.39 x 21.59 x 5.40 cm)	12/ctn

Conductive Storage Bins

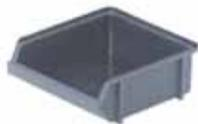

3006C



3007C



3008C



3005C

Model Number	Stock Number	Description	Dimensions (Inside, L x W x D)	Packed
3006C	6771BC	Color: Black	4-1/4" x 4" x 1-1/2" (10.80 x 10.16 x 3.81 cm)	24/ctn
3007C	6772BC	Color: Black	4-1/4" x 5" x 2-1/2" (10.80 x 12.70 x 6.35 cm)	24/ctn
3008C	6773BC	Color: Black	4-1/4" x 6-1/2" x 3-1/4" (10.80 x 16.51 x 8.26 cm)	12/ctn
3005C	6774BC	Color: Black	4-1/4" x 8-3/4" x 5-1/4" (10.80 x 22.23 x 13.34 cm)	12/ctn

* Width is measured from back to front straight edge before flare out.

Conductive Storage Cabinets/Rototower™



Holds 16 Cabinets.

Uses the C26P-C and U45P-C Cabinets.

Not shown to scale, with cabinets to left.



161 CRT Rototower™

All cabinets include (10) 35/52C dividers, all other dividers are optional

Model Number	Stock Number	Description	Uses Drawer	Uses Divider	Dimensions (Outside, L x W x H)	Packed
C20P-C	6575CD	Color: Black Black Drawers Black Dividers	(15) TW-C (4) TQ-C (1) TF-C	35/52C 50/64C 57/275C	12" x 6-1/4" x 11-1/4" (30.48 x 15.88 x 28.58 cm)	4/ctn
C26P-C	6576CD	Color: Black Black Drawers Black Dividers	(15) TW-C (8) TQ-C (2) TJ-C (1) TF-C	35/52C 50/64C 57/135C 57/275C	12" x 6-1/4" x 16-1/2" (30.48 x 15.88 x 41.91 cm)	4/ctn
U30P-C	6573CD	Color: Black Black Drawers Black Dividers	(30) TW-C	35/52C	12" x 6-1/4" x 11-1/4" (30.48 x 15.88 x 28.58 cm)	4/ctn
U45P-C	6574CD	Color: Black Black Drawers Black Dividers	(45) TW-C	35/52C	12" x 6-1/4" x 16-1/2" (30.48 x 15.88 x 41.91 cm)	4/ctn
161 CRT	6797RT	Black Rototower Holds 16 Cabinets. Uses C26P-C & U45P-C Cabinets Sold Separately	-	-	18-1/2" x 18-1/2" x 72-1/2"* (46.99 x 46.99 x 184.15 cm)	1/ctn

* from floor to top of cabinet

Conductive Replacement Drawers & Dividers* (Plastic Frame Cabinets)

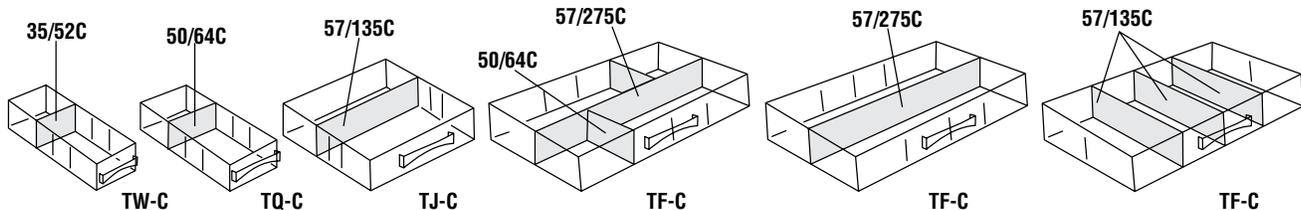

Model Number	Stock Number	Description	Dimensions (Inside, L x W x D)	Packed
TW-C	6061DP	Uses (3) 35/52C dividers, dividers sold separately	2" x 5-3/8" x 1-3/8" (5.08 x 13.65 x 3.49 cm)	6/pk
TQ-C	6064DP	Uses (3) 50/64C dividers, dividers sold separately	2-1/2" x 5-3/8" x 2-1/4" (6.35 x 13.65 x 5.72 cm)	6/pk
TJ-C	6065DP	Uses (3) 57/135C dividers, dividers sold separately	5-3/8" x 5-3/8" x 2-1/4" (13.65 x 13.65 x 5.72 cm)	6/pk
TF-C	6067DP	Uses (3) 57/135C or (1) 57/275C or (1) 57/275C & (6) 50/64C dividers, dividers sold separately	10-7/8" x 5-3/8" x 2-1/4" (27.62 x 13.65 x 5.72 cm)	6/pk

Model Number	Stock Number	Description	Dimensions (Inside, L x W x D)	Packed
35/52C	6780CD	Divider fits in Drawer TW-C, Divider wall thickness 1/16" (1.588 cm)	2" x 1-1/4" x 1/8" (5.08 x 3.18 x 0.32 cm)	25/pk
50/64C	6785CD	Divider fits in Drawer TQ-C & TF-C, Divider wall thickness 1/16" (1.588 cm)	2-1/2" x 2" x 1/8" (6.35 x 5.08 x 0.32 cm)	24/pk
57/135C	6782CD	Divider fits in Drawers TF-C & TJ-C, Divider wall thickness 1/16" (1.588 cm)	5-3/8" x 2" x 1/8" (13.65 x 5.08 x 0.32 cm)	12/pk
57/275C	6784CD	Divider fits in Drawers TF-C, Divider wall thickness 1/16" (1.588 cm)	10-7/8" x 2" x 1/8" (27.62 x 5.08 x 0.32 cm)	6/pk

* Contact Customer Service for large quantity divider purchases at 1-800-344-5716.

TABLE OF CONTENTS

OVERVIEW & CAPABILITIES Pages 2 - 13

- 2..... Company Overview - What's New From Flambeau
- 3..... Biodegradable
- 4..... Custom Soft-side
- 5..... Special Programs & Offerings
- 6..... Capabilities
- 7..... Zerust® & Tarnish Inhibitor
- 8-10..... Custom Manufacturing, Stock & Options
- 11..... FAQ's

COMPARTMENTED BOXES Pages 14 - 34

- 12-13 Compartmented Box Families Available
- 14-17 Reference Charts – Box Size
- 18-19 Reference Chart – Number of Compartments
- 20-31 Boxes Listed from Smallest to Largest Dimension
- 32..... Deep Super Satchel™, Slim Super Satchel™ & Tarnish Inhibitor Slim Super Satchel™ Boxes
- 33..... Deluxe Super Satchel™ Boxes
Double Deep Super Satchel™ Box
- 34..... Tuff Tainer® & Super Satchel, Tarnish Inhibitor Zerust® & Non-Zerust Divider Packs
IDS (Infinite Divider System) Divider Packs

CASES Pages 35 - 48

- 35..... Tradesman™ & Merchant X Cases
- 36..... More Tradesman & Merchant X Cases
- 37..... Defender™ Case Series
- 38-39 Infinity™ Cases
- 40-41 "P" Series Cases
- 42-44 Airmold® "R" Series Cases
- 44..... Beta Case
- 45..... Black Ribbon Cases
- 46-47.... Accessories: Handles & Latches
- 48..... Blow Molded Tradesman & Mailers

SPECIALTY STORAGE Pages 49 - 54

- 49..... IDS™ Cabinets
- 50..... Parts Station™ Storage Cabinets
Parts Station Rototower™
Parts Station Replacement Drawers & Dividers
- 51..... Large Satchel-Style Cases
- 52 Carry Packs™, Step 'N Store™ Stool & Expandable Tube
- 53 **NEW** Gun Cases: Economy Single Gun Case, Single Gun Case, Double Gun Case & Pistol Pack Series
- 54..... Utility Workstation™ Cart & Bin Storage Systems

TOOL BOXES Pages 55 - 61

- 55 **NEW** Rolling Tote Storage Cabinet & Blow Molded Tool Boxes
- 56..... Utility Boxes & Utility Boxes with Lift-Out Trays
- 57..... Utility Boxes with Cantilever Trays
- 58..... Low Boy™ Tool Box, Expandable Building Box & Versatile Utility Tool Box, Tailgator™
- 59..... Gear Boxes
- 60..... Lil' Brute™ Utility/Tool Box, Utility Tote, Utility Bench Box, Tool Chests
- 61..... Drawer Cabinets, Drawer Cabinet Replacement
Drawer Packs & Tool Chest Replacement Drawer Packs

MEDICAL Pages 62 - 64

- 62 **NEW** Medical Device Box, Paramedic Gear Box & Paramedic Case
- 63..... First Aid Cases, Paramedic Case & Instrument Boxes
- 64..... Command Center Box, Trauma Drug Kits & Drawer Cabinets

CONDUCTIVE Pages 65 - 67

- 65..... Conductive Cases
- 66..... Conductive Tool Box, 600/800 Series Boxes & Conductive Storage Bins
- 67..... Conductive Storage Cabinets, Conductive Cabinet Rototower™ & Conductive Cabinet Replacement Drawers & Dividers



Customer Service: (800) 344-5716

15981 Valplast Street, Middlefield, Ohio 44062

PH: (440) 632-1631 • Fax: (440) 632-1581

Check us out at: www.flambeaucases.com



© 2011 Flambeau® Inc. All Rights Reserved. Zerust® is a registered trademark of Northern Technologies International Corporation.