

# GL Series

## C Type



[RoHS Compliant]



Model	Rated voltage AC/DC (V)	Rated current AC/DC (A)	Withstanding voltage 1 min., line to ground AC (V)	Insulation resistance 500VDC 1 min., line to ground (MΩ) min.	Leakage current 250V/60Hz, (μA) max.	Self-temperature rise (K) max.	Operating temperature range (°C)	Certified standard	Weight (g)
GL-2030C	250	3	1500	300	500	30	-25~+55	UL, CSA, TÜV, VDE	55
GL-2060C	250	6	1500	300	500	30	-25~+55	UL, CSA, TÜV, VDE	55
GL-2100C	250	10	1500	300	500	30	-25~+55	UL, CSA, TÜV	55
GL-2150C	250	15	1500	300	500	30	-25~+55	UL, CSA, TÜV	55
GL-2030C2	250	3	1500	300	500	30	-25~+55	UL, CSA, TÜV	55
GL-2030C3	250	3	1500	300	500	30	-25~+55	UL, CSA, TÜV	55
GL-2060C3	250	6	1500	300	500	30	-25~+55	UL, CSA, TÜV	55
GL-2060C1	250	6	1500	300	5	30	-25~+55	UL, CSA	55
GL-2080C1	250	8	1500	300	5	30	-25~+55	UL, CSA, TÜV	55
GL-2080C4	250	8	1500	300	500	30	-25~+55	UL, CSA, TÜV	55
GL-2030CT	250	3	1500	300	5	30	-25~+55	UL	55
GL-2060C4	250	6	1500	300	500	30	-25~+55	UL, CSA, TÜV	55

### Shape and Dimensions

●GL-C Type

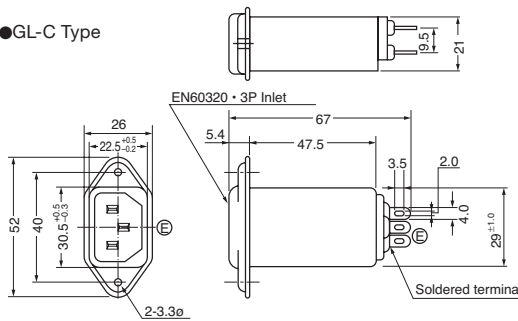

Reference installation dimensions

(1) For rear panel installation (2) For front panel installation

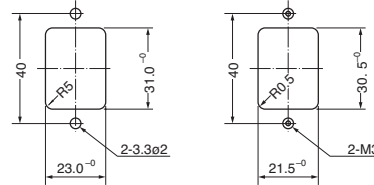

\*Recommended torque (N·m) max. ◆Panel installation (M3: 0.78) [mm]

### Circuit Diagram

●GL-C, C2, C3, C4 Type

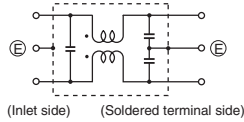

●GL-C1

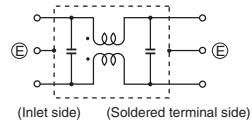

●GL-CT

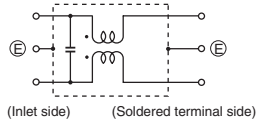

### Measuring Circuit

●Common mode

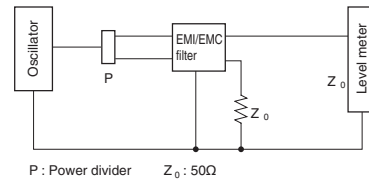

●Normal mode

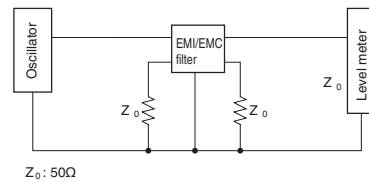

- All specifications in this catalog and production status of products are subject to change without notice. Prior to the purchase, please contact TOKIN for updated product data.
- Please request for a specification sheet for detailed product data prior to the purchase.
- Before using the product in this catalog, please read "Precautions" and other safety precautions listed in the printed version catalog.

**Attenuation (Static Characteristics)**

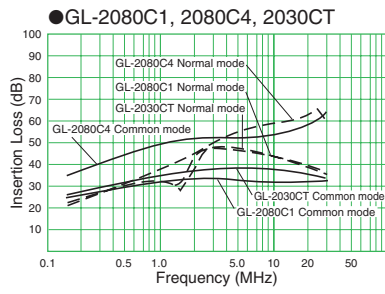
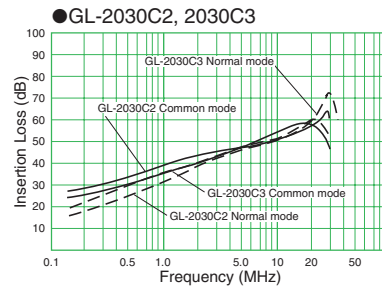
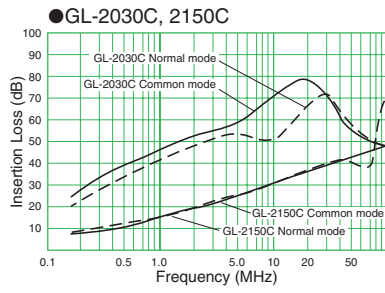

- All specifications in this catalog and production status of products are subject to change without notice. Prior to the purchase, please contact TOKIN for updated product data.
- Please request for a specification sheet for detailed product data prior to the purchase.
- Before using the product in this catalog, please read "Precautions" and other safety precautions listed in the printed version catalog.